

AC Servo Drives
 Σ -V Series
USER'S MANUAL
Design and Maintenance
Rotational Motor
Analog Voltage and Pulse Train Reference

SGDV SERVOPACK
SGMJV/SGMAV/SGMPS/SGMGV/SGMSV/SGMCS Servomotors

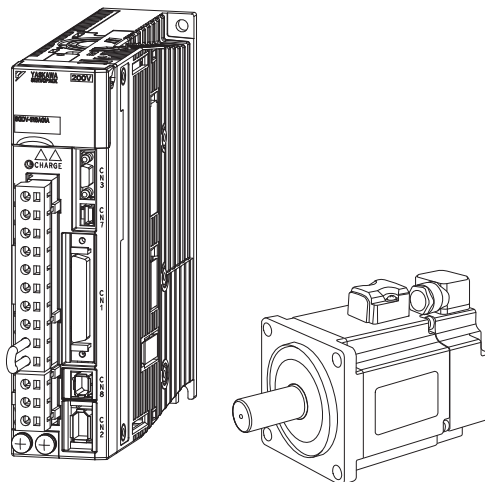

Outline	1
Panel Operator	2
Wiring and Connection	3
Trial Operation	4
Operation	5
Adjustments	6
Utility Functions (Fn□□□)	7
Monitor Displays (Un□□□)	8
Fully-closed Loop Control	9
Troubleshooting	10
Appendix	11

Copyright © 2007 YASKAWA ELECTRIC CORPORATION

All rights reserved. No part of this publication may be reproduced, stored in a retrieval system, or transmitted, in any form, or by any means, mechanical, electronic, photocopying, recording, or otherwise, without the prior written permission of Yaskawa. No patent liability is assumed with respect to the use of the information contained herein. Moreover, because Yaskawa is constantly striving to improve its high-quality products, the information contained in this manual is subject to change without notice. Every precaution has been taken in the preparation of this manual. Nevertheless, Yaskawa assumes no responsibility for errors or omissions. Neither is any liability assumed for damages resulting from the use of the information contained in this publication.

About this Manual

This manual describes information required for designing, testing, adjusting, and maintaining Σ -V Series SERVOPACKs.

Keep this manual in a location where it can be accessed for reference whenever required. Manuals outlined on the following page must also be used as required by the application.

■ Description of Technical Terms

The following table shows the meanings of terms used in this manual.

Term	Meaning
Cursor	Input position indicated by Digital Operator
Servomotor	Σ -V Series SGMJV, SGMAV, SGMPS, SGMGV, SGMSV, or SGMCS (Direct Drive) servomotor
SERVOPACK	Σ -V Series SGDV servo amplifier
Servo Drive	A set including a servomotor and SERVOPACK (i.e., a servo amplifier)
Servo System	A servo control system that includes the combination of a servo drive with a host controller and peripheral devices
Analog Pulse Model	Analog voltage and pulse train reference used for SERVOPACK interface
Servo ON	Power to motor ON
Servo OFF	Power to motor OFF
Base Block (BB)	Power supply to motor is turned OFF by shutting off the base current to the power transistor in the current amplifier.
Servo Lock	A state in which the motor is stopped and is in position loop with a position reference of 0.
Main Circuit Cable	Cables which connect to the main circuit terminals, including main circuit power supply cables, control power supply cables, servomotor main circuit cables, and others.

■ IMPORTANT Explanations

The following icon is displayed for explanations requiring special attention.



IMPORTANT

- Indicates important information that should be memorized, as well as precautions, such as alarm displays, that do not involve potential damage to equipment.

■ Notation Used in this Manual

• Notation for Reverse Signals

The names of reverse signals (i.e., ones that are valid when low) are written with a forward slash (/) before the signal name.

Notation Example

$\overline{\text{BK}}$ = /BK

• Notation for Parameters

The notation depends on whether the parameter requires a value setting (parameter for numeric settings) or requires the selection of a function (parameter for selecting functions).

• Parameters for Numeric Settings

Control methods for which the parameter applies.
Speed : Speed control Position : Position control Torque : Torque control

Pn406	Emergency Stop Torque				
	Setting Range	Setting Unit	Factory Setting	When Enabled	Classification
	0% to 800%	1%	800	After change	Setup

Parameter number

Indicates the setting range for the parameter.

Indicates the minimum setting unit for the parameter.

Indicates the parameter setting before shipment.

Indicates when a change to the parameter will be effective.

Indicates the parameter classification.

• Parameters for Selecting Functions

Parameter	Meaning	When Enabled	Classification
Pn002	n.□0□□ [Factory setting]	After restart	Setup
	n.□1□□		

Parameter number

The notation "n.□□□□" indicates a parameter for selecting functions. Each □ corresponds to the setting value of that digit. The notation shown here means that the third digit is 1.

This section explains the selections for the function.

Notation Example

Panel Operator Display (Display Example for Pn002)

	Digit Notation		Setting Notation	
	Notation	Meaning	Notation	Meaning
1st digit	Pn002.0	Indicates the value for the 1st digit of parameter Pn002.	Pn002.0 = x or n.□□□x	Indicates that the value for the 1st digit of parameter Pn002 is x.
2nd digit	Pn002.1	Indicates the value for the 2nd digit of parameter Pn002.	Pn002.1 = x or n.□□x□	Indicates that the value for the 2nd digit of parameter Pn002 is x.
3rd digit	Pn002.2	Indicates the value for the 3rd digit of parameter Pn002.	Pn002.2 = x or n.□x□□	Indicates that the value for the 3rd digit of parameter Pn002 is x.
4th digit	Pn002.3	Indicates the value for the 4th digit of parameter Pn002.	Pn002.3 = x or n.x□□□	Indicates that the value for the 4th digit of parameter Pn002 is x.

■ Manuals Related to the Σ -V Series

Refer to the following manuals as required.

Name	Selecting Models and Peripheral Devices	Ratings and Specifications	System Design	Panels and Wiring	Trial Operation	Trial Operation and Servo Adjustment	Maintenance and Inspection
Σ -V Series User's Manual Setup Rotational Motor (No.: SIEP S800000 43)				✓	✓		
Σ -V Series Product Catalog (No.: KAEP S800000 42)	✓	✓	✓				
Σ -V Series User's Manual Design and Maintenance Rotational Motor/ Analog Voltage and Pulse Train Reference (this manual)			✓		✓	✓	✓
Σ -V Series User's Manual Operation of Digital Operator (No.: SIEP S800000 55)					✓	✓	✓
Σ -V Series AC SERVOPACK SGD Safety Precautions (No.: TOBP C710800 10)	✓			✓			✓
Σ Series Digital Operator Safety Precautions (No.: TOBP C730800 00)							✓
AC SERVOMOTOR Safety Precautions (No.: TOBP C230200 00)				✓			✓

■ Safety Information

The following conventions are used to indicate precautions in this manual. Failure to heed precautions provided in this manual can result in serious or possibly even fatal injury or damage to the products or to related equipment and systems.



Indicates precautions that, if not heeded, could possibly result in loss of life or serious injury.



Indicates precautions that, if not heeded, could result in relatively serious or minor injury, damage to the product, or faulty operation. In some situations, the precautions indicated could have serious consequences if not heeded.



Indicates prohibited actions that must not be performed. For example, this symbol would be used to indicate that fire is prohibited as follows:



Indicates compulsory actions that must be performed. For example, this symbol would be used to indicate that grounding is compulsory as follows:





Safety Precautions

This section describes important precautions that must be followed during storage, transportation, installation, wiring, operation, maintenance, inspection, and disposal. Be sure to always observe these precautions thoroughly.



WARNING

- Never touch any rotating servomotor parts during operation.
Failure to observe this warning may result in injury.
- Before starting operation with a machine connected, make sure that an emergency stop can be applied at any time.
Failure to observe this warning may result in injury or damage to the equipment.
- Never touch the inside of the SERVOPACKs.
Failure to observe this warning may result in electric shock.
- Do not remove the cover of the power supply terminal block while the power is ON.
Failure to observe this warning may result in electric shock.
- After the power is turned OFF or after a voltage resistance test, do not touch terminals while the CHARGE lamp is ON.
Residual voltage may cause electric shock.
- Follow the procedures and instructions provided in the manuals for the products being used in the trial operation.
Failure to do so may result not only in faulty operation and damage to equipment, but also in personal injury.
- The output range of the rotational serial data for the Σ -V absolute position detecting system is different from that of earlier systems for 12-bit and 15-bit encoders. As a result, the infinite-length positioning system of the Σ Series must be changed for use with products in the Σ -V Series.
- The multiturn limit value need not be changed except for special applications.
Changing it inappropriately or unintentionally can be dangerous.
- If the Multiturn Limit Disagreement alarm occurs, check the setting of parameter Pn205 in the SERVOPACK to be sure that it is correct.
If Fn013 is executed when an incorrect value is set in Pn205, an incorrect value will be set in the encoder. The alarm will disappear even if an incorrect value is set, but incorrect positions will be detected, resulting in a dangerous situation where the machine will move to unexpected positions.
- Do not remove the top front cover, cables, connectors, or optional items from the SERVOPACK while the power is ON.
Failure to observe this warning may result in electric shock.
- Do not damage, pull, exert excessive force on, or place heavy objects on the cables.
Failure to observe this warning may result in electric shock, stopping operation of the product, or fire.
- Do not modify the product.
Failure to observe this warning may result in injury, damage to the equipment, or fire.
- Provide appropriate braking devices on the machine side to ensure safety. The holding brake on a servomotor with a brake is not a braking device for ensuring safety.
Failure to observe this warning may result in injury.
- Do not come close to the machine immediately after resetting an instantaneous power interruption to avoid an unexpected restart. Take appropriate measures to ensure safety against an unexpected restart.
Failure to observe this warning may result in injury.
-  Connect the ground terminal according to local electrical codes (100 Ω or less for a SERVOPACK with a 100 V, 200 V power supply, 10 Ω or less for a SERVOPACK with a 400 V power supply).
Improper grounding may result in electric shock or fire.
-  Installation, disassembly, or repair must be performed only by authorized personnel.
Failure to observe this warning may result in electric shock or injury.
- The person who designs a system using the safety function (Hard Wire Baseblock function) must have full knowledge of the related safety standards and full understanding of the instructions in this manual.
Failure to observe this warning may result in injury or damage to the equipment.

■ Storage and Transportation

 CAUTION
<ul style="list-style-type: none">• Do not store or install the product in the following locations. Failure to observe this caution may result in fire, electric shock, or damage to the equipment.<ul style="list-style-type: none">• Locations subject to direct sunlight• Locations subject to temperatures outside the range specified in the storage/installation temperature conditions• Locations subject to humidity outside the range specified in the storage/installation humidity conditions• Locations subject to condensation as the result of extreme changes in temperature• Locations subject to corrosive or flammable gases• Locations subject to dust, salts, or iron dust• Locations subject to exposure to water, oil, or chemicals• Locations subject to shock or vibration• Do not hold the product by the cables, motor shaft, or encoder while transporting it. Failure to observe this caution may result in injury or malfunction.• Do not place any load exceeding the limit specified on the packing box. Failure to observe this caution may result in injury or malfunction.• If disinfectants or insecticides must be used to treat packing materials such as wooden frames, pallets, or plywood, the packing materials must be treated before the product is packaged, and methods other than fumigation must be used. Example: Heat treatment, where materials are kiln-dried to a core temperature of 56°C for 30 minutes or more. If the electronic products, which include stand-alone products and products installed in machines, are packed with fumigated wooden materials, the electrical components may be greatly damaged by the gases or fumes resulting from the fumigation process. In particular, disinfectants containing halogen, which includes chlorine, fluorine, bromine, or iodine can contribute to the erosion of the capacitors.

■ Installation

 CAUTION
<ul style="list-style-type: none">• Never use the product in an environment subject to water, corrosive gases, flammable gases, or combustibles. Failure to observe this caution may result in electric shock or fire.• Do not step on or place a heavy object on the product. Failure to observe this caution may result in injury or malfunction.• Do not cover the inlet or outlet ports and prevent any foreign objects from entering the product. Failure to observe this caution may cause internal elements to deteriorate resulting in malfunction or fire.• Be sure to install the product in the correct direction. Failure to observe this caution may result in malfunction.• Provide the specified clearances between the SERVOPACK and the control panel or with other devices. Failure to observe this caution may result in fire or malfunction.• Do not apply any strong impact. Failure to observe this caution may result in malfunction.

■ Wiring



CAUTION

- Be sure to wire correctly and securely.
Failure to observe this caution may result in motor overrun, injury, or malfunction.
- Do not connect a commercial power supply to the U, V, or W terminals for the servomotor connection.
Failure to observe this caution may result in injury or fire.
- Securely connect the main circuit terminals.
Failure to observe this caution may result in fire.
- Do not bundle or run the main circuit cables together with the I/O signal cables or the encoder cables in the same duct. Keep the main circuit cables separated from the I/O signal cables and the encoder cables with a gap of at least 30 cm.
Placing these cables too close to each other may result in malfunction.
- Use shielded twisted-pair cables or screened unshielded twisted-pair cables for I/O signal cables and the encoder cables.
- The maximum wiring length is 3 m for I/O signal cables, 50 m for encoder cables or servomotor main circuit cables, and 10 m for control power supply cables for the SERVOPACK with a 400-V power supply (+24 V, 0 V).
- Do not touch the power supply terminals while the CHARGE lamp is ON after turning power OFF because high voltage may still remain in the SERVOPACK.
Make sure the charge indicator is OFF first before starting to do wiring or inspections.
- Be sure to observe the following precautions when wiring the SERVOPACK main circuit terminal blocks.
 - Do not turn the SERVOPACK power ON until all wiring, including the main circuit terminal blocks, has been completed.
 - Remove detachable main circuit terminals from the SERVOPACK prior to wiring.
 - Insert only one power line per opening in the main circuit terminals.
 - Make sure that no part of the core wire comes into contact with (i.e., short-circuits) adjacent wires.
- Install a battery at either the host controller or the SERVOPACK, but not both.
It is dangerous to install batteries at both ends simultaneously, because that sets up a loop circuit between the batteries.
- Always use the specified power supply voltage.
An incorrect voltage may result in fire or malfunction.
- Make sure that the polarity is correct.
Incorrect polarity may cause ruptures or damage.
- Take appropriate measures to ensure that the input power supply is supplied within the specified voltage fluctuation range. Be particularly careful in places where the power supply is unstable.
An incorrect power supply may result in damage to the equipment.
- Install external breakers or other safety devices against short-circuiting in external wiring.
Failure to observe this caution may result in fire.
- Take appropriate and sufficient countermeasures for each form of potential interference when installing systems in the following locations.
 - Locations subject to static electricity or other forms of noise
 - Locations subject to strong electromagnetic fields and magnetic fields
 - Locations subject to possible exposure to radioactivity
 - Locations close to power suppliesFailure to observe this caution may result in damage to the equipment.
- Do not reverse the polarity of the battery when connecting it.
Failure to observe this caution may damage the battery, the SERVOPACK or servomotor, or cause an explosion.
- Wiring or inspection must be performed by a technical expert.
- Use a 24-VDC power supply with double insulation or reinforced insulation.

■ Operation

 CAUTION
<ul style="list-style-type: none">• Always use the servomotor and SERVOPACK in one of the specified combinations. Failure to observe this caution may result in fire or malfunction.• Conduct trial operation on the servomotor alone with the motor shaft disconnected from the machine to avoid accidents. Failure to observe this caution may result in injury.• During trial operation, confirm that the holding brake works correctly. Furthermore, secure system safety against problems such as signal line disconnection.• Before starting operation with a machine connected, change the parameter settings to match the parameters of the machine. Starting operation without matching the proper settings may cause the machine to run out of control or malfunction.• Do not turn the power ON and OFF more than necessary. Do not use the SERVOPACK for applications that require the power to turn ON and OFF frequently. Such applications will cause elements in the SERVOPACK to deteriorate. As a guideline, at least one hour should be allowed between the power being turned ON and OFF once actual operation has been started.• When carrying out JOG operation (Fn002), origin search (Fn003), or EasyFFT (Fn206), forcing movable machine parts to stop does not work for forward overtravel or reverse overtravel. Take necessary precautions. Failure to observe this caution may result in damage to the equipment.• When using the servomotor for a vertical axis, install safety devices to prevent workpieces from falling due to alarms or overtravels. Set the servomotor so that it will stop in the zero clamp state when overtravel occurs. Failure to observe this caution may cause workpieces to fall due to overtravel.• When not using the turning-less function, set the correct moment of inertia ratio (Pn103). Setting an incorrect moment of inertia ratio may cause machine vibration.• Do not touch the SERVOPACK heat sinks, regenerative resistor, or servomotor while power is ON or soon after the power is turned OFF. Failure to observe this caution may result in burns due to high temperatures.• Do not make any extreme adjustments or setting changes of parameters. Failure to observe this caution may result in injury or damage to the equipment due to unstable operation.• When an alarm occurs, remove the cause, reset the alarm after confirming safety, and then resume operation. Failure to observe this caution may result in damage to the equipment, fire, or injury.• Do not use the holding brake of the servomotor for braking. Failure to observe this caution may result in malfunction.• An alarm or warning may occur if communications are performed with the host controller while the SigmaWin+ or Digital Operator is operating. If an alarm or warning occurs, it may stop the current process and stop the system.

■ Maintenance and Inspection

 CAUTION
<ul style="list-style-type: none">• Do not disassemble the SERVOPACK and the servomotor. Failure to observe this caution may result in electric shock or injury.• Do not attempt to change wiring while the power is ON. Failure to observe this caution may result in electric shock or injury.• When replacing the SERVOPACK, resume operation only after copying the previous SERVOPACK parameters to the new SERVOPACK. Failure to observe this caution may result in damage to the equipment.

■ Disposal

 CAUTION
<ul style="list-style-type: none">• When disposing of the products, treat them as ordinary industrial waste.

■ General Precautions

**Observe the following general precautions
to ensure safe application.**

- The products shown in illustrations in this manual are sometimes shown without covers or protective guards. Always replace the cover or protective guard as specified first, and then operate the products in accordance with the manual.
- The drawings presented in this manual are typical examples and may not match the product you received.
- If the manual must be ordered due to loss or damage, inform your nearest Yaskawa representative or one of the offices listed on the back of this manual.

Warranty

(1) Details of Warranty

■ Warranty Period

The warranty period for a product that was purchased (hereinafter called “delivered product”) is one year from the time of delivery to the location specified by the customer or 18 months from the time of shipment from the Yaskawa factory, whichever is sooner.

■ Warranty Scope

Yaskawa shall replace or repair a defective product free of charge if a defect attributable to Yaskawa occurs during the warranty period above. This warranty does not cover defects caused by the delivered product reaching the end of its service life and replacement of parts that require replacement or that have a limited service life.

This warranty does not cover failures that result from any of the following causes.

1. Improper handling, abuse, or use in unsuitable conditions or in environments not described in product catalogs or manuals, or in any separately agreed-upon specifications
2. Causes not attributable to the delivered product itself
3. Modifications or repairs not performed by Yaskawa
4. Abuse of the delivered product in a manner in which it was not originally intended
5. Causes that were not foreseeable with the scientific and technological understanding at the time of shipment from Yaskawa
6. Events for which Yaskawa is not responsible, such as natural or human-made disasters

(2) Limitations of Liability

1. Yaskawa shall in no event be responsible for any damage or loss of opportunity to the customer that arises due to failure of the delivered product.
2. Yaskawa shall not be responsible for any programs (including parameter settings) or the results of program execution of the programs provided by the user or by a third party for use with programmable Yaskawa products.
3. The information described in product catalogs or manuals is provided for the purpose of the customer purchasing the appropriate product for the intended application. The use thereof does not guarantee that there are no infringements of intellectual property rights or other proprietary rights of Yaskawa or third parties, nor does it construe a license.
4. Yaskawa shall not be responsible for any damage arising from infringements of intellectual property rights or other proprietary rights of third parties as a result of using the information described in catalogs or manuals.

(3) Suitability for Use

1. It is the customer's responsibility to confirm conformity with any standards, codes, or regulations that apply if the Yaskawa product is used in combination with any other products.
2. The customer must confirm that the Yaskawa product is suitable for the systems, machines, and equipment used by the customer.
3. Consult with Yaskawa to determine whether use in the following applications is acceptable. If use in the application is acceptable, use the product with extra allowance in ratings and specifications, and provide safety measures to minimize hazards in the event of failure.
 - Outdoor use, use involving potential chemical contamination or electrical interference, or use in conditions or environments not described in product catalogs or manuals
 - Nuclear energy control systems, combustion systems, railroad systems, aviation systems, vehicle systems, medical equipment, amusement machines, and installations subject to separate industry or government regulations
 - Systems, machines, and equipment that may present a risk to life or property
 - Systems that require a high degree of reliability, such as systems that supply gas, water, or electricity, or systems that operate continuously 24 hours a day
 - Other systems that require a similar high degree of safety
4. Never use the product for an application involving serious risk to life or property without first ensuring that the system is designed to secure the required level of safety with risk warnings and redundancy, and that the Yaskawa product is properly rated and installed.
5. The circuit examples and other application examples described in product catalogs and manuals are for reference. Check the functionality and safety of the actual devices and equipment to be used before using the product.
6. Read and understand all use prohibitions and precautions, and operate the Yaskawa product correctly to prevent accidental harm to third parties.

(4) Specifications Change

The names, specifications, appearance, and accessories of products in product catalogs and manuals may be changed at any time based on improvements and other reasons. The next editions of the revised catalogs or manuals will be published with updated code numbers. Consult with your Yaskawa representative to confirm the actual specifications before purchasing a product.

Harmonized Standards

■ North American Safety Standards (UL)



	Model	UL Standards (UL File No.)
SERVOPACK	SGDV	UL508C (E147823)
Servomotor	<ul style="list-style-type: none"> • SGMJV • SGMAV • SGMPS • SGMGV • SGMSV 	UL1004 (E165827)

■ European Directives



	Model	European Directives	Harmonized Standards
SERVOPACK	SGDV	Machinery Directive 2006/42/EC	EN ISO13849-1: 2008 EN 954-1
		EMC Directive 2004/108/EC	EN 55011 group 1 class A EN 61000-6-2 EN 61800-3
		Low Voltage Directive 2006/95/EC	EN 50178 EN 61800-5-1
Servomotor	<ul style="list-style-type: none"> • SGMJV • SGMAV • SGMPS • SGMGV • SGMSV 	EMC Directive 2004/108/EC	EN 55011 group 1 class A EN 61000-6-2 EN 61800-3
		Low Voltage Directive 2006/95/EC	EN 60034-1 EN 60034-5

■ Safety Standards



	Model	Safety Standards	Standards
SERVOPACK	SGDV	Safety of Machinery	EN ISO13849-1: 2008 EN 954-1 IEC 60204-1
		Functional Safety	IEC 61508 series IEC 62061 IEC 61800-5-2
		EMC	IEC 61326-3-1

■ Safe Performance

Items	Standards	Performance Level
Safety Integrity Level	IEC 61508	SIL2
	IEC 62061	SILCL2
Probability of Dangerous Failure per Hour	IEC 61508 IEC 62061	$PFH \leq 1.7 \times 10^{-9}$ [1/h] (0.17% of SIL2)
Category	EN 954-1	Category 3
Performance Level	EN ISO 13849-1	PL d (Category 3)
Mean Time to Dangerous Failure of Each Channel	EN ISO 13849-1	MTTFd: High
Average Diagnostic Coverage	EN ISO 13849-1	DCave: Low
Stop Category	IEC 60204-1	Stop category 0
Safety Function	IEC 61800-5-2	STO
Proof test Interval	IEC 61508	10 years

Contents

About this Manual	iii
Safety Precautions	vi
Warranty	xi
Harmonized Standards	xiii

Chapter 1 Outline 1-1

1.1 Σ -V Series SERVOPACKS	1-2
1.2 Part Names	1-2
1.3 SERVOPACK Ratings and Specifications	1-3
1.3.1 Ratings	1-3
1.3.2 Basic Specifications	1-5
1.3.3 Speed/Position/Torque Control	1-8
1.4 SERVOPACK Internal Block Diagrams	1-9
1.4.1 Single-phase 100 V, SGD V-R70F01A, -R90F01A, -2R1F01A Models	1-9
1.4.2 Single-phase 100 V, SGD V-2R8F01A Model	1-9
1.4.3 Single-phase 200 V, SGD V-120A01A008000 Model	1-10
1.4.4 Three-phase 200 V, SGD V-R70A01□, -R90A01□, -1R6A01□ Models	1-10
1.4.5 Three-phase 200 V, SGD V-2R8A01□ Model	1-11
1.4.6 Three-phase 200 V, SGD V-3R8A01A, -5R5A01A, -7R6A01A Models	1-11
1.4.7 Three-phase 200 V, SGD V-120A01A Model	1-12
1.4.8 Three-phase 200 V, SGD V-180A01A, -200A01A Models	1-12
1.4.9 Three-phase 200 V, SGD V-330A01A Model	1-13
1.4.10 Three-phase 200 V, SGD V-470A01A, -550A01A Models	1-13
1.4.11 Three-phase 200 V, SGD V-590A01A, -780A01A Models	1-14
1.4.12 Three-phase 400 V, SGD V-1R9D01A, -3R5D01A, -5R4D01A Models	1-14
1.4.13 Three-phase 400 V, SGD V-8R4D01A, -120D01A Models	1-15
1.4.14 Three-phase 400 V, SGD V-170D01A Model	1-15
1.4.15 Three-phase 400 V, SGD V-210D01A, -260D01A Models	1-16
1.4.16 Three-phase 400 V, SGD V-280D01A, -370D01A Models	1-16
1.5 Examples of Servo System Configurations	1-17
1.5.1 Connecting to SGD V-□□□F01A SERVOPACK	1-17
1.5.2 Connecting to SGD V-□□□A01□ SERVOPACK	1-18
1.5.3 Connecting to SGD V-□□□D01A SERVOPACK	1-20
1.6 SERVOPACK Model Designation	1-21
1.7 Inspection and Maintenance	1-22

Chapter 2 Panel Operator 2-1

2.1 Overview	2-2
2.1.1 Names and Functions	2-2
2.1.2 Display Selection	2-2
2.1.3 Status Display	2-3
2.2 Utility Functions (Fn□□□)	2-4
2.3 Parameters (Pn□□□)	2-5
2.3.1 Parameter Classification	2-5
2.3.2 Notation for Parameters	2-5
2.3.3 Setting Parameters	2-6
2.4 Monitor Displays (Un□□□)	2-9

Chapter 3 Wiring and Connection	3-1
3.1 Main Circuit Wiring	3-2
3.1.1 Main Circuit Terminals	3-2
3.1.2 Using a Standard Power Supply (Single-phase 100 V, Three-phase 200 V, or Three-phase 400 V)	3-3
3.1.3 Using the SERVOPACK with Single-phase, 200 V Power Input	3-11
3.1.4 Using the SERVOPACK with a DC Power Input	3-15
3.1.5 Using More Than One SERVOPACK	3-17
3.1.6 General Precautions for Wiring	3-18
3.2 I/O Signal Connections	3-19
3.2.1 I/O Signal (CN1) Names and Functions	3-19
3.2.2 Safety Function Signal (CN8) Names and Functions	3-21
3.2.3 Example of I/O Signal Connections in Speed Control	3-22
3.2.4 Example of I/O Signal Connections in Position Control	3-23
3.2.5 Example of I/O Signal Connections in Torque Control	3-24
3.3 I/O Signal Allocations	3-25
3.3.1 Input Signal Allocations	3-25
3.3.2 Output Signal Allocations	3-29
3.4 Examples of Connection to Host Controller	3-33
3.4.1 Reference Input Circuit	3-33
3.4.2 Sequence Input Circuit	3-35
3.4.3 Sequence Output Circuit	3-37
3.5 Encoder Connection	3-39
3.5.1 Encoder Signal (CN2) Names and Functions	3-39
3.5.2 Encoder Connection Examples	3-39
3.6 Connecting Regenerative Resistors	3-41
3.6.1 Connecting Regenerative Resistors	3-41
3.6.2 Setting Regenerative Resistor Capacity	3-43
3.7 Noise Control and Measures for Harmonic Suppression	3-44
3.7.1 Wiring for Noise Control	3-44
3.7.2 Precautions on Connecting Noise Filter	3-46
3.7.3 Connecting a Reactor for Harmonic Suppression	3-47

Chapter 4 Trial Operation	4-1
4.1 Inspection and Checking before Trial Operation	4-2
4.2 Trial Operation for Servomotor without Load	4-2
4.3 Trial Operation for Servomotor without Load from Host Reference	4-3
4.3.1 Inspecting Connection and Status of Input Signals	4-5
4.3.2 Trial Operation in Speed Control	4-8
4.3.3 Trial Operation under Position Control from the Host Controller with the SERVOPACK Used for Speed Control	4-9
4.3.4 Trial Operation in Position Control	4-10
4.4 Trial Operation with the Servomotor Connected to the Machine	4-11
4.5 Trial Operation of Servomotor with Brakes	4-12
4.6 Test Without Motor Function	4-13
4.6.1 Motor Information	4-13
4.6.2 Motor Position and Speed Responses	4-14
4.6.3 Limitations	4-15
4.6.4 Operator Displays during Testing without Motor	4-16

Chapter 5 Operation	5-1
5.1 Control Method Selection	5-3
5.2 Basic Functions Settings	5-4
5.2.1 Servo ON Signal	5-4
5.2.2 Servomotor Rotation Direction	5-5
5.2.3 Overtravel	5-6
5.2.4 Holding Brakes	5-9
5.2.5 Stopping Servomotors after /S-ON Turned OFF or Alarm Occurrence	5-14
5.2.6 Instantaneous Power Interruption Settings	5-16
5.2.7 SEMI F47 Function (Torque Limit Function for Low DC Power Supply Voltage for Main Circuit)	5-17
5.2.8 Setting Motor Overload Detection Level	5-20
5.3 Speed Control	5-22
5.3.1 Basic Settings for Speed Control	5-22
5.3.2 Reference Offset Adjustment	5-23
5.3.3 Soft Start	5-26
5.3.4 Speed Reference Filter	5-26
5.3.5 Zero Clamp Function	5-27
5.3.6 Encoder Output Pulses	5-29
5.3.7 Setting Encoder Output Pulse	5-30
5.3.8 Setting Speed Coincidence Signal	5-31
5.4 Position Control	5-32
5.4.1 Basic Settings for Position Control	5-33
5.4.2 Clear Signal Setting	5-37
5.4.3 Reference Pulse Input Multiplication Switching Function	5-38
5.4.4 Electronic Gear	5-39
5.4.5 Smoothing	5-42
5.4.6 Positioning Completed Signal	5-43
5.4.7 Positioning Near Signal	5-44
5.4.8 Reference Pulse Inhibit Function	5-45
5.5 Torque Control	5-46
5.5.1 Basic Settings for Torque Control	5-46
5.5.2 Reference Offset Adjustment	5-47
5.5.3 Torque Reference Filter	5-50
5.5.4 Speed Limit in Torque Control	5-50
5.6 Internal Set Speed Control	5-52
5.6.1 Basic Settings for Speed Control with an Internal Set Speed	5-52
5.6.2 Example of Operating with Internal Set Speeds	5-54
5.7 Combination of Control Methods	5-55
5.7.1 Switching Internal Set Speed Control (Pn000.1 = 4, 5, or 6)	5-55
5.7.2 Switching Other Than Internal Set Speed Control (Pn000.1 = 7, 8 or 9)	5-58
5.7.3 Switching Other Than Internal Set Speed Control (Pn000.1 = A or B)	5-58
5.8 Limiting Torque	5-59
5.8.1 Internal Torque Limit	5-59
5.8.2 External Torque Limit	5-60
5.8.3 Torque Limiting Using an Analog Voltage Reference	5-61
5.8.4 Torque Limiting Using an External Torque Limit and Analog Voltage Reference	5-63
5.8.5 Checking Output Torque Limiting during Operation	5-65
5.9 Absolute Encoders	5-66
5.9.1 Connecting the Absolute Encoder	5-67
5.9.2 Absolute Data Request Signal (SEN)	5-69
5.9.3 Battery Replacement	5-70
5.9.4 Absolute Encoder Setup and Reinitialization	5-73
5.9.5 Absolute Data Reception Sequence	5-74
5.9.6 Multiturn Limit Setting	5-77
5.9.7 Multiturn Limit Disagreement Alarm (A.CC0)	5-78

5.10 Other Output Signals	5-79
5.10.1 Servo Alarm Output Signal (ALM) and Alarm Code Output Signals (ALO1, ALO2, and ALO3)	5-79
5.10.2 Warning Output Signal (/WARN)	5-80
5.10.3 Rotation Detection Output Signal (/TGON)	5-81
5.10.4 Servo Ready Output Signal (/S-RDY)	5-81
5.11 Safety Function	5-82
5.11.1 Hard Wire Base Block (HWBB) Function	5-82
5.11.2 External Device Monitor (EDM1)	5-86
5.11.3 Application Example of Safety Functions	5-88
5.11.4 Confirming Safety Functions	5-89
5.11.5 Precautions for Safety Functions	5-89
Chapter 6 Adjustments	6-1
6.1 Type of Adjustments and Basic Adjustment Procedure	6-3
6.1.1 Adjustments	6-3
6.1.2 Basic Adjustment Procedure	6-5
6.1.3 Monitoring Operation during Adjustment	6-6
6.1.4 Safety Precautions on Adjustment of Servo Gains	6-9
6.2 Tuning-less Function	6-12
6.2.1 Tuning-less Function	6-12
6.2.2 Tuning-less Levels Setting (Fn200) Procedure	6-15
6.2.3 Related Parameters	6-18
6.3 Advanced Autotuning (Fn201)	6-19
6.3.1 Advanced Autotuning	6-19
6.3.2 Advanced Autotuning Procedure	6-22
6.3.3 Related Parameters	6-28
6.4 Advanced Autotuning by Reference (Fn202)	6-29
6.4.1 Advanced Autotuning by Reference	6-29
6.4.2 Advanced Autotuning by Reference Procedure	6-32
6.4.3 Related Parameters	6-36
6.5 One-parameter Tuning (Fn203)	6-37
6.5.1 One-parameter Tuning	6-37
6.5.2 One-parameter Tuning Procedure	6-39
6.5.3 One-parameter Tuning Example	6-46
6.5.4 Related Parameters	6-47
6.6 Anti-Resonance Control Adjustment Function (Fn204)	6-48
6.6.1 Anti-Resonance Control Adjustment Function	6-48
6.6.2 Anti-Resonance Control Adjustment Function Operating Procedure	6-49
6.6.3 Related Parameters	6-53
6.7 Vibration Suppression Function (Fn205)	6-54
6.7.1 Vibration Suppression Function	6-54
6.7.2 Vibration Suppression Function Operating Procedure	6-55
6.7.3 Related Parameters	6-58
6.8 Additional Adjustment Function	6-59
6.8.1 Switching Gain Settings	6-59
6.8.2 Manual Adjustment of Friction Compensation	6-63
6.8.3 Current Control Mode Selection Function	6-65
6.8.4 Current Gain Level Setting	6-65
6.8.5 Speed Detection Method Selection	6-65
6.9 Compatible Adjustment Function	6-66
6.9.1 Feedforward Reference	6-66
6.9.2 Torque Feedforward	6-66
6.9.3 Speed Feedforward	6-68
6.9.4 Proportional Control	6-69
6.9.5 Mode Switch (P/PI Switching)	6-70
6.9.6 Torque Reference Filter	6-72
6.9.7 Position Integral	6-74

Chapter 7 Utility Functions (Fn□□□)	7-1
7.1 List of Utility Functions	7-2
7.2 Alarm History Display (Fn000)	7-3
7.3 JOG Operation (Fn002)	7-4
7.4 Origin Search (Fn003)	7-6
7.5 Program JOG Operation (Fn004)	7-8
7.6 Initializing Parameter Settings (Fn005)	7-12
7.7 Clearing Alarm History (Fn006)	7-13
7.8 Offset Adjustment of Analog Monitor Output (Fn00C)	7-14
7.9 Gain Adjustment of Analog Monitor Output (Fn00D)	7-16
7.10 Automatic Offset-Signal Adjustment of the Motor Current Detection Signal (Fn00E)	7-18
7.11 Manual Offset-Signal Adjustment of the Motor Current Detection Signal (Fn00F)	7-19
7.12 Write Prohibited Setting (Fn010)	7-20
7.13 Servomotor Model Display (Fn011)	7-22
7.14 Software Version Display (Fn012)	7-24
7.15 Resetting Configuration Errors in Option Modules (Fn014)	7-25
7.16 Vibration Detection Level Initialization (Fn01B)	7-26
7.17 Display of SERVOPACK and Servomotor ID (Fn01E)	7-28
7.18 Display of Servomotor ID in Feedback Option Module (Fn01F)	7-30
7.19 Origin Setting (Fn020)	7-32
7.20 Software Reset (Fn030)	7-33
7.21 EasyFFT (Fn206)	7-34
7.22 Online Vibration Monitor (Fn207)	7-37

Chapter 8 Monitor Displays (Un□□□)	8-1
8.1 List of Monitor Displays	8-2
8.2 Viewing Monitor Displays	8-3
8.3 Reading 32-bit Data in Decimal Displays	8-4
8.4 Monitoring Input Signals	8-5
8.4.1 Displaying Input Signal Status	8-5
8.4.2 Interpreting Input Signal Display Status	8-5
8.4.3 Input Signal Display Example	8-6
8.5 Monitoring Output Signals	8-7
8.5.1 Displaying Output Signal Status	8-7
8.5.2 Interpreting Output Signal Display Status	8-8
8.5.3 Output Signal Display Example	8-8
8.6 Monitoring Safety Input Signals	8-9
8.6.1 Displaying Safety Input Signals	8-9
8.6.2 Interpreting Safety Input Signal Display Status	8-9
8.6.3 Safety Input Signal Display Example	8-10
8.7 Monitor Display at Power ON	8-10

Chapter 9 Fully-closed Loop Control	9-1
9.1 System Configuration and Connection Example for SERVOPACK with Fully-closed Loop Control	9-2
9.1.1 System Configuration	9-2
9.1.2 Internal Block Diagram of Fully-closed Loop Control	9-3
9.1.3 Serial Converter Unit	9-3
9.1.4 Example of Connections to External Encoders	9-5
9.1.5 Encoder Output Pulse Signals from SERVOPACK with an External Encoder by Renishaw plc.	9-6
9.1.6 Precautions When Using an External Incremental Encoder by Magnescale	9-7
9.2 SERVOPACK Startup Procedure	9-10
9.3 Parameter Settings for Fully-closed Loop Control	9-12
9.3.1 Motor Rotation Direction	9-13
9.3.2 Sine Wave Pitch (Frequency) for an External Encoder	9-15
9.3.3 Setting Encoder Output Pulses (PAO, PBO, and PCO)	9-15
9.3.4 External Absolute Encoder Data Reception Sequence	9-16
9.3.5 Electronic Gear	9-19
9.3.6 Alarm Detection	9-20
9.3.7 Analog Monitor Signal	9-21
9.3.8 Speed Feedback Method during Fully-closed Loop Control	9-21
 Chapter 10 Troubleshooting	 10-1
10.1 Alarm Displays	10-2
10.1.1 List of Alarms	10-2
10.1.2 Troubleshooting of Alarms	10-6
10.2 Warning Displays	10-21
10.2.1 List of Warnings	10-21
10.2.2 Troubleshooting of Warnings	10-22
10.3 Troubleshooting Malfunction Based on Operation and Conditions of the Servomotor	10-25
 Chapter 11 Appendix	 11-1
11.1 Connection to Host Controller	11-2
11.1.1 Connection to MP2200/MP2300 Motion Module SVA-01	11-2
11.1.2 Connection to MP920 Servo Module SVA-01A	11-3
11.1.3 Connection to OMRON's Motion Control Unit	11-4
11.1.4 Connection to OMRON's Position Control Unit	11-5
11.1.5 Connection to MITSUBISHI's AD72 Positioning Module (SERVOPACK in Speed Control)	11-6
11.1.6 Connection to MITSUBISHI's AD75 Positioning Module (SERVOPACK in Position Control)	11-7
11.1.7 Connection to MITSUBISHI's QD75D□ Positioning Module (SERVOPACK in Position Control)	11-8
11.2 List of Parameters	11-9
11.2.1 Utility Functions	11-9
11.2.2 Parameters	11-10
11.3 List of Monitor Displays	11-35
11.4 Parameter Recording Table	11-36
 Index	 Index-1
 Revision History	

Outline

1.1 Σ -V Series SERVOPACKs	1-2
1.2 Part Names	1-2
1.3 SERVOPACK Ratings and Specifications	1-3
1.3.1 Ratings	1-3
1.3.2 Basic Specifications	1-5
1.3.3 Speed/Position/Torque Control	1-8
1.4 SERVOPACK Internal Block Diagrams	1-9
1.4.1 Single-phase 100 V, SGD V-R70F01A, -R90F01A, -2R1F01A Models	1-9
1.4.2 Single-phase 100 V, SGD V-2R8F01A Model	1-9
1.4.3 Single-phase 200 V, SGD V-120A01A008000 Model	1-10
1.4.4 Three-phase 200 V, SGD V-R70A01□, -R90A01□, -1R6A01□ Models	1-10
1.4.5 Three-phase 200 V, SGD V-2R8A01□ Model	1-11
1.4.6 Three-phase 200 V, SGD V-3R8A01A, -5R5A01A, -7R6A01A Models	1-11
1.4.7 Three-phase 200 V, SGD V-120A01A Model	1-12
1.4.8 Three-phase 200 V, SGD V-180A01A, -200A01A Models	1-12
1.4.9 Three-phase 200 V, SGD V-330A01A Model	1-13
1.4.10 Three-phase 200 V, SGD V-470A01A, -550A01A Models	1-13
1.4.11 Three-phase 200 V, SGD V-590A01A, -780A01A Models	1-14
1.4.12 Three-phase 400 V, SGD V-1R9D01A, -3R5D01A, -5R4D01A Models	1-14
1.4.13 Three-phase 400 V, SGD V-8R4D01A, -120D01A Models	1-15
1.4.14 Three-phase 400 V, SGD V-170D01A Model	1-15
1.4.15 Three-phase 400 V, SGD V-210D01A, -260D01A Models	1-16
1.4.16 Three-phase 400 V, SGD V-280D01A, -370D01A Models	1-16
1.5 Examples of Servo System Configurations	1-17
1.5.1 Connecting to SGD V-□□□F01A SERVOPACK	1-17
1.5.2 Connecting to SGD V-□□□A01□ SERVOPACK	1-18
1.5.3 Connecting to SGD V-□□□D01A SERVOPACK	1-20
1.6 SERVOPACK Model Designation	1-21
1.7 Inspection and Maintenance	1-22

1.1 Σ-V Series SERVOPACKs

The Σ-V Series SERVOPACKs are designed for applications that require frequent high-speed, high-precision positioning. The SERVOPACK makes the most of machine performance in the shortest time possible, thus contributing to improving productivity.

1.2 Part Names

This section describes the part names of SGD-V SERVOPACK for analog voltage and pulse train reference.

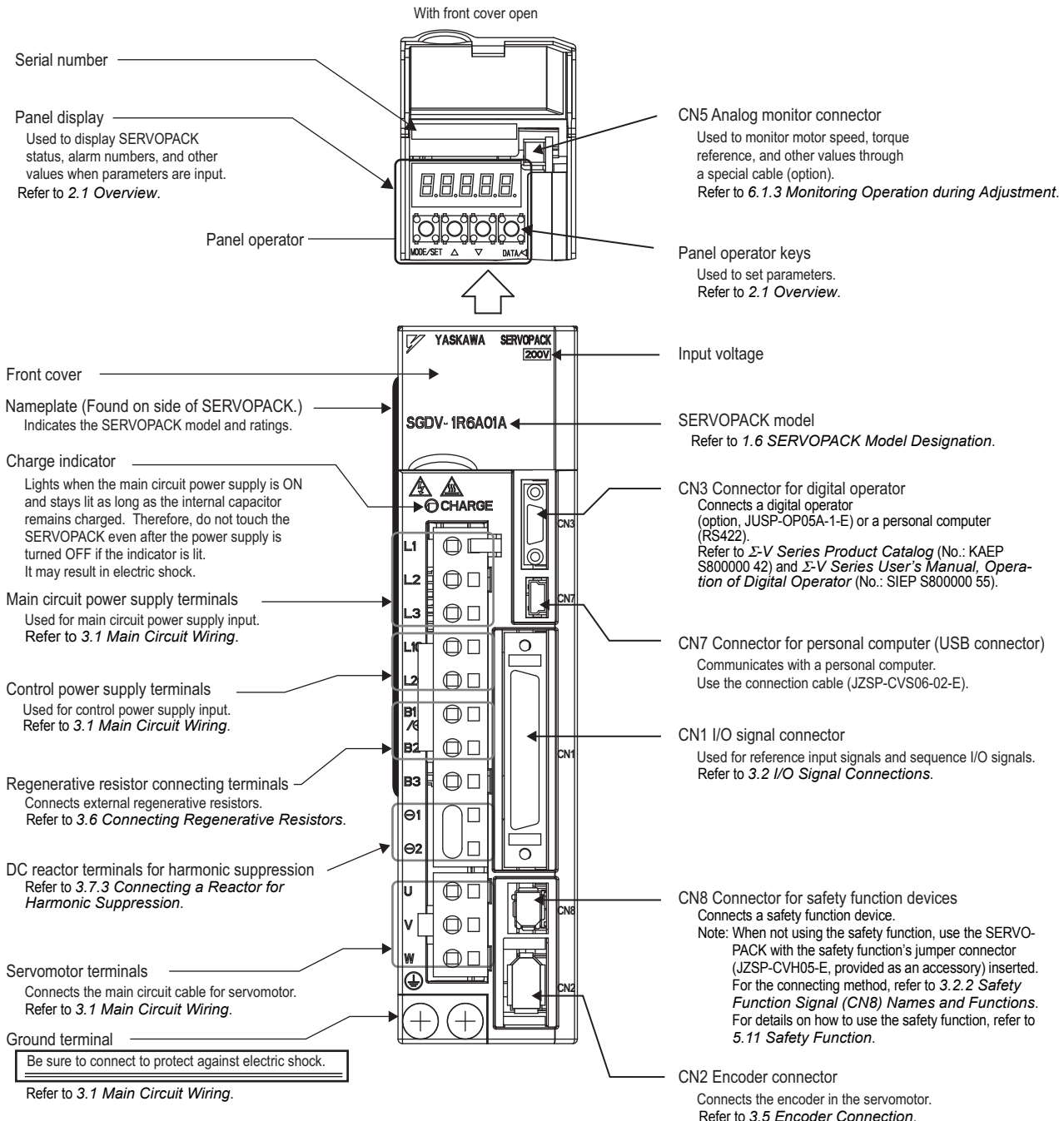

1.3 SERVOPACK Ratings and Specifications

This section describes the ratings and specifications of SERVOPACKs.

1.3.1 Ratings

Ratings of SERVOPACKs are as shown below.

(1) SGDV with Single-phase, 100-V Rating

SGDV (Single Phase, 100 V)	R70	R90	2R1	2R8
Continuous Output Current [Arms]	0.66	0.91	2.1	2.8
Instantaneous Max. Output Current [Arms]	2.1	2.9	6.5	9.3
Regenerative Resistor *	None or external			
Main Circuit Power Supply	Single-phase, 100 to 115 VAC $\begin{smallmatrix} +10\% \\ -15\% \end{smallmatrix}$, 50/60 Hz			
Control Power Supply	Single-phase, 100 to 115 VAC $\begin{smallmatrix} +10\% \\ -15\% \end{smallmatrix}$, 50/60 Hz			
Overvoltage Category	III			

* Refer to 3.6 *Connecting Regenerative Resistors* for details.

(2) SGDV with Single-phase, 200-V Rating

SGDV (Single Phase, 200 V)	120 *1
Continuous Output Current [Arms]	11.6
Instantaneous Max. Output Current [Arms]	28
Regenerative Resistor *2	Built-in or external
Main Circuit Power Supply	Single-phase, 220 to 230 VAC $\begin{smallmatrix} +10\% \\ -15\% \end{smallmatrix}$, 50/60 Hz
Control Power Supply	Single-phase, 220 to 230 VAC $\begin{smallmatrix} +10\% \\ -15\% \end{smallmatrix}$, 50/60 Hz
Overvoltage Category	III

*1. The official model number is SGDV-120A01A008000.

*2. Refer to 3.6 *Connecting Regenerative Resistors* for details.

(3) SGDV with Three-phase, 200-V Rating

SGDV (Three Phase, 200 V)	R70	R90	1R6	2R8	3R8	5R5	7R6	120	180	200	330	470	550	590	780
Continuous Output Current [Arms]	0.66	0.91	1.6	2.8	3.8	5.5	7.6	11.6	18.5	19.6	32.9	46.9	54.7	58.6	78.0
Instantaneous Max. Output Current [Arms]	2.1	2.9	5.8	9.3	11.0	16.9	17	28	42	56	84	110	130	140	170
Regenerative Resistor *	None or external				Built-in or external						External				
Main Circuit Power Supply	Three-phase, 200 to 230 VAC $\begin{smallmatrix} +10\% \\ -15\% \end{smallmatrix}$, 50/60 Hz														
Control Power Supply	Single-phase, 200 to 230 VAC $\begin{smallmatrix} +10\% \\ -15\% \end{smallmatrix}$, 50/60 Hz														
Overvoltage Category	III														

* Refer to 3.6 *Connecting Regenerative Resistors* for details.

(4) SGD V with Three-phase, 400-V Rating

SGDV (Three Phase, 400 V)	1R9	3R5	5R4	8R4	120	170	210	260	280	370
Continuous Output Current [Arms]	1.9	3.5	5.4	8.4	11.9	16.5	20.8	25.7	28.1	37.2
Instantaneous Max. Output Current [Arms]	5.5	8.5	14	20	28	42	55	65	70	85
Regenerative Resistor *	Built-in or external						External			
Main Circuit Power Supply	Three-phase, 380 to 480 VAC ^{+10%} _{-15%} , 50/60 Hz									
Control Power Supply	24 VDC ±15%									
Overvoltage Category	III									

* Refer to 3.6 *Connecting Regenerative Resistors* for details.

1.3.2 Basic Specifications

Basic specifications of SERVOPACKs are shown below.

Drive Method		Sine-wave current drive with PWM control of IGBT		
Feedback		Encoder: 13-bit (incremental), 17-bit, 20-bit (incremental/absolute)		
Operating Conditions	Surrounding Air Temperature	0°C to +55°C		
	Storage Temperature	-20°C to +85°C		
	Ambient Humidity	90% RH or less	With no freezing or condensation	
	Storage Humidity	90% RH or less		
	Vibration Resistance	4.9 m/s ²		
	Shock Resistance	19.6 m/s ²		
	Protection Class	IP10	An environment that satisfies the following conditions. <ul style="list-style-type: none"> • Free of corrosive or flammable gases • Free of exposure to water, oil, or chemicals • Free of dust, salts, or iron dust 	
	Pollution Degree	2		
	Altitude	1000 m or less		
	Others	Free of static electricity, strong electromagnetic fields, magnetic fields or exposure to radioactivity		
Harmonized Standards		UL508C EN50178, EN55011 group1 class A, EN61000-6-2, EN61800-3, EN61800-5-1, EN954-1, IEC61508-1 to 4		
Mounting		Standard: Base-mounted Optional: Rack-mounted or duct-ventilated		
Performance	Speed Control Range		1:5000 (The lower limit of the speed control range must be lower than the point at which the rated torque does not cause the servomotor to stop.)	
	Speed Regulation*1	Load Regulation	0% to 100% load: ±0.01% max. (at rated speed)	
		Voltage Regulation	Rated voltage ±10%: 0% (at rated speed)	
		Temperature Regulation	25 ± 25 °C: ±0.1% max. (at rated speed)	
	Torque Control Tolerance (Repeatability)		±1%	
Soft Start Time Setting		0 to 10 s (Can be set individually for acceleration and deceleration.)		

(cont'd)

I/O Signals	Encoder Output Pulse		Phase A, B, C: line driver Encoder output pulse: any setting ratio (Refer to 5.3.7.)		
	Sequence Input	Fixed Input	SEN signal		
		Input Signals which can be allocated	Number of Channels	7 ch	
	Functions		<ul style="list-style-type: none"> • Servo ON (/S-ON) • Proportional control (/P-CON) • Forward run prohibited (P-OT), reverse run prohibited (N-OT) • Alarm reset (/ALM-RST) • Forward external torque limit (/P-CL), reverse external torque limit (/N-CL) • Internal set speed selection (/SPD-D, /SPD-A, /SPD-B) • Control selection (/C-SEL) • Zero clamping (/ZCLAMP) • Reference pulse inhibit (/INHIBIT) • Gain selection (/G-SEL) • Reference pulse input multiplication switching (/PSEL) Signal allocations can be performed, and positive and negative logic can be changed.		
	Sequence Output	Fixed Output	Servo alarm (ALM), alarm code (ALO1, ALO2, ALO3) outputs		
		Output Signals which can be allocated	Number of Channels	3 ch	
Functions	<ul style="list-style-type: none"> • Positioning completion (/COIN) • Speed coincidence detection (/V-CMP) • Rotation detection (/TGON) • Servo ready (/S-RDY) • Torque limit detection (/CLT) • Speed limit detection (/VLT) • Brake (/BK) • Warning (/WARN) • Near (/NEAR) • Reference pulse input multiplication switching output (/PSELA) Signal allocations can be performed, and positive and negative logic can be changed.				
Communications Function	RS422A Communications (CN3)	Interface	Digital operator (JUSP-OP05A-1-E), personal computer (can be connected with SigmaWin+)		
		1:N Communications	N = Up to 15 stations possible at RS422A		
		Axis Address Setting	Set by parameter		
	USB Communications (CN7)	Interface	Personal computer (can be connected with SigmaWin+)		
Communications Standard		Complies with standard USB1.1. (12 Mbps)			
LED Display		CHARGE indicator			
Panel Operator Functions	Display Unit	Five 7-segment LEDs			
	Switches	Four push switches			
Analog Monitor (CN5)		Number of points: 2 Output voltage: ± 10 VDC (linearity effective range ± 8 V) Resolution: 16 bits Accuracy: ± 20 mV (Typ) Max. output current: ± 10 mA Settling time ($\pm 1\%$): 1.2 ms (Typ)			

(cont'd)

Dynamic Brake (DB)	Activated when a servo alarm or overtravelling occurs or when the power supply for the main circuit or servomotor is OFF.	
Regenerative Processing	Included *2	
Overtravel Prevention (OT)	Dynamic brake stop, deceleration to a stop, or free run to a stop at P-OT or N-OT	
Protective Function	Overcurrent, overvoltage, insufficient voltage, overload, regeneration error, and so on.	
Utility Function	Gain adjustment, alarm history, JOG operation, origin search, and so on.	
Safety Function	Input	/HWBB1, /HWBB2: Baseblock signal for power module
	Output	EDM1: Monitoring status of internal safety circuit (fixed output)
	Standards *3	EN954 Category 3, IEC61508 SIL2
Option Module	Fully-closed module, safety module	

*1. Speed regulation by load regulation is defined as follows:

$$\text{Speed regulation} = \frac{\text{No-load motor speed} - \text{Total load motor speed}}{\text{Rated motor speed}} \times 100\%$$

*2. Refer to *1.3.1 Ratings* for details on regenerative resistors.

*3. Perform risk assessment for the system and be sure that the safety requirements are fulfilled.

1.3.3 Speed/Position/Torque Control

The following table shows the basic specifications at speed/position/torque control.

Control Method		Specifications		
Speed Control	Performance	Soft Start Time Setting	0 to 10 s (Can be set individually for acceleration and deceleration.)	
	Input Signals	Reference Voltage	<ul style="list-style-type: none"> Max. input voltage: ± 12 V (forward speed reference with positive reference) Factory setting: 6 VDC at rated speed Input gain setting can be varied.	
		Input Impedance	Approx. 14 k Ω	
		Circuit Time Constant	30 μ s	
	Internal Set Speed Control	Rotation Direction Selection	With P control signal	
		Speed Selection	With forward/reverse external torque limit signal (speed 1 to 3 selection). Servomotor stops or another control method is used when both are OFF.	
Position Control	Performance	Feedforward Compensation	0% to 100%	
		Positioning Completed Width Setting	0 to 1073741824 reference units	
	Input Signals	Reference Pulse	Type	Select one of them: Sign + pulse train, CW + CCW pulse train, or two-phase pulse train with 90° phase differential
			Form	For line driver, open collector
		Max. Input Pulse Frequency	Line driver	Sign + pulse train, CW + CCW pulse train: 4 Mpps Two-phase pulse train with 90° phase differential: 1 Mpps
			Open Collector	Sign + pulse train, CW + CCW pulse train: 200 kpps Two-phase pulse train with 90° phase differential: 200 kpps
	Reference Pulse Input Multiplication Switching	1 to 100 times		
Clear Signal	Position error clear For line driver, open collector			
Torque Control	Input Signals	Reference Voltage	<ul style="list-style-type: none"> Max. input voltage: ± 12 V (forward torque reference with positive reference) Factory setting: 3 VDC at rated torque Input gain setting can be varied.	
		Input Impedance	Approx. 14 k Ω	
		Circuit Time Constant	16 μ s	

1.4 SERVOPACK Internal Block Diagrams

1.4.1 Single-phase 100 V, SGD V-R70F01A, -R90F01A, -2R1F01A Models

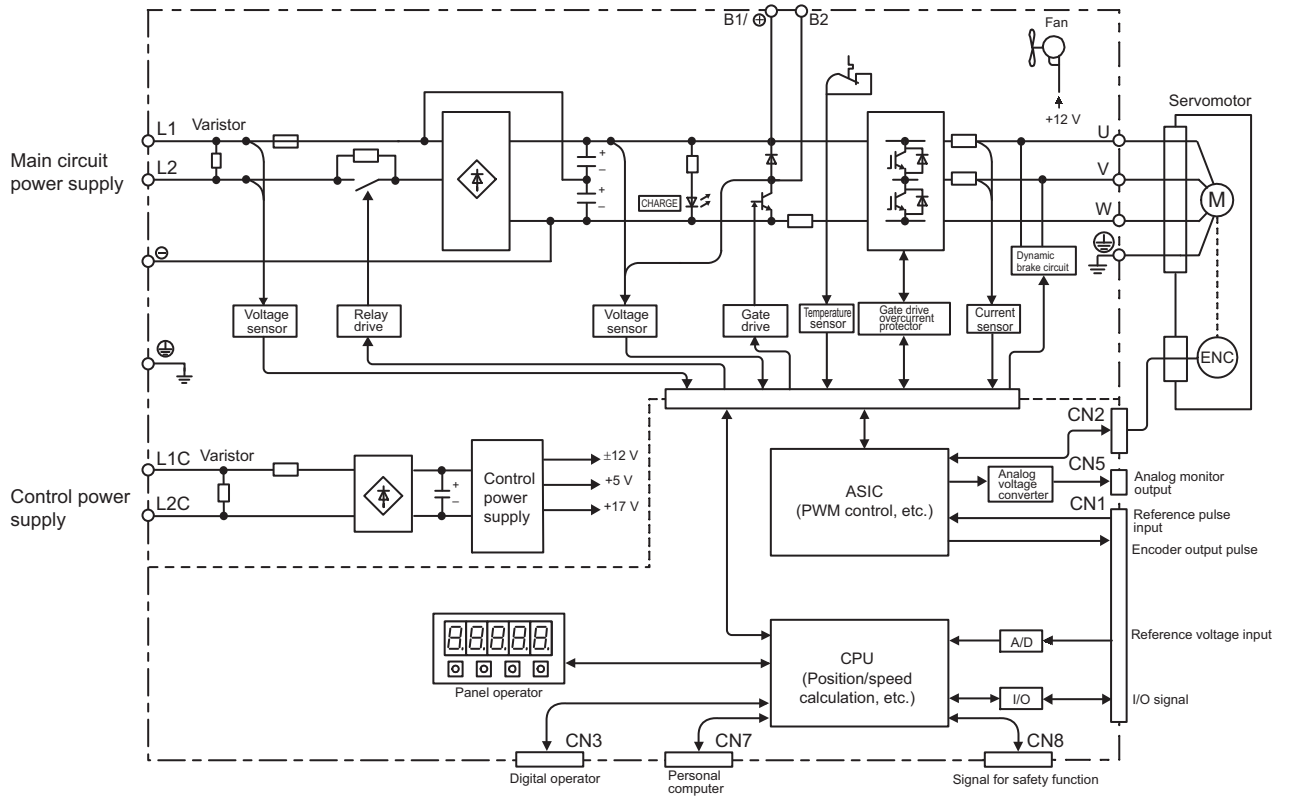

1.4.2 Single-phase 100 V, SGD V-2R8F01A Model

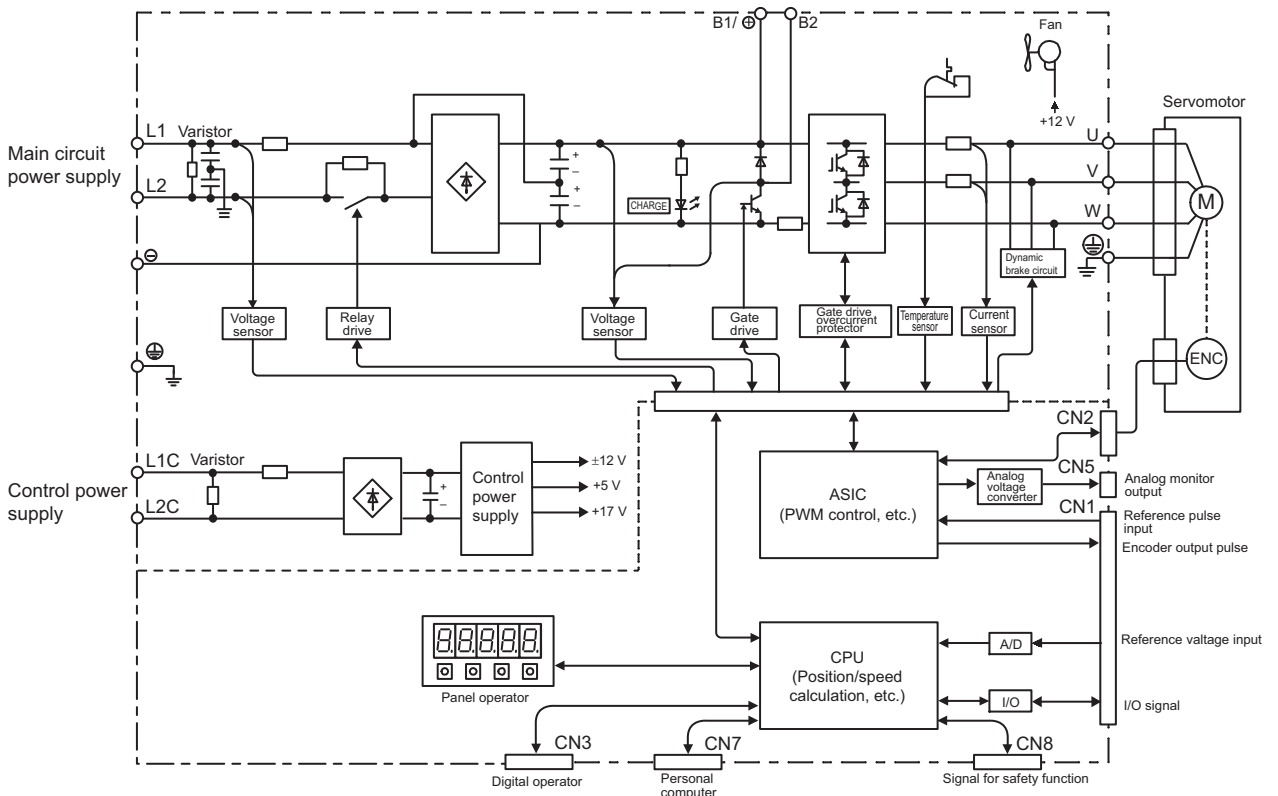

1.4.3 Single-phase 200 V, SGDV-120A01A008000 Model

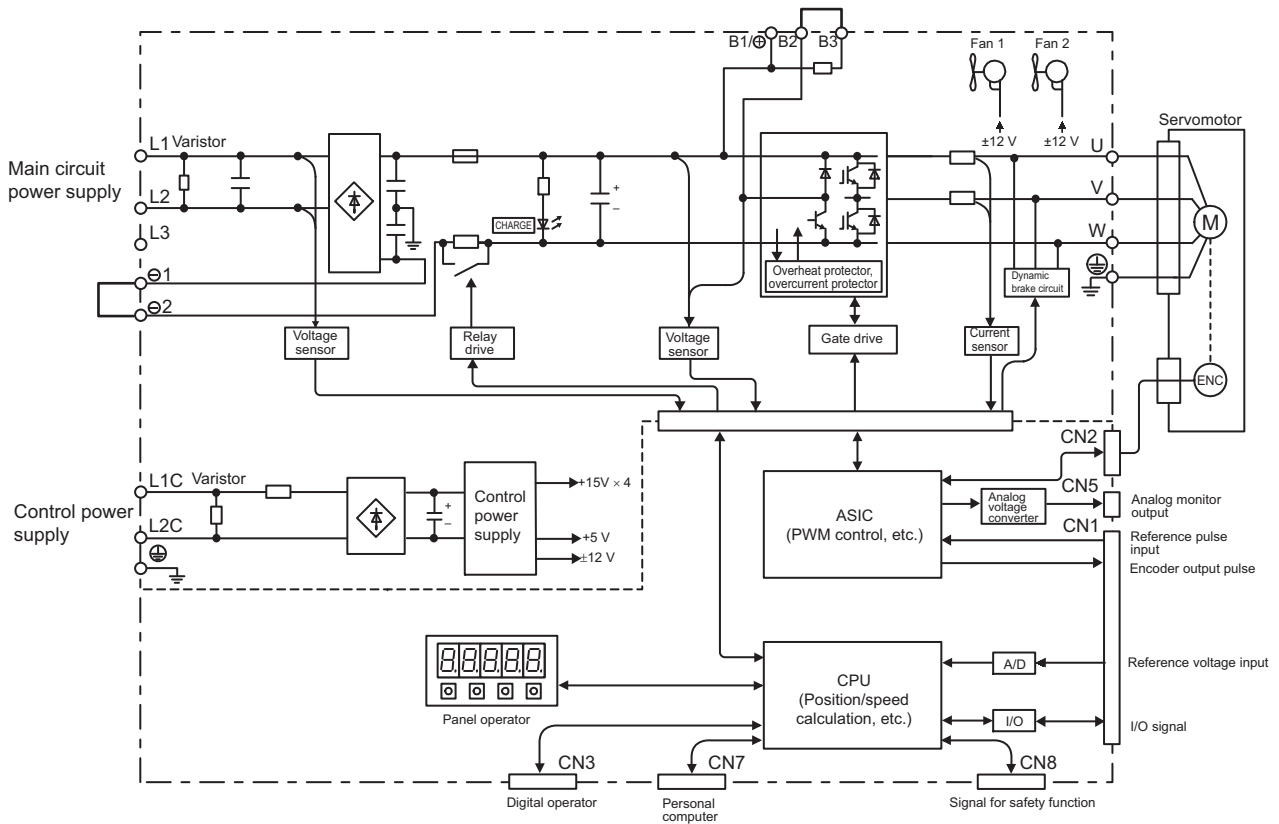

1.4.4 Three-phase 200 V, SGDV-R70A01□, -R90A01□, -1R6A01□ Models

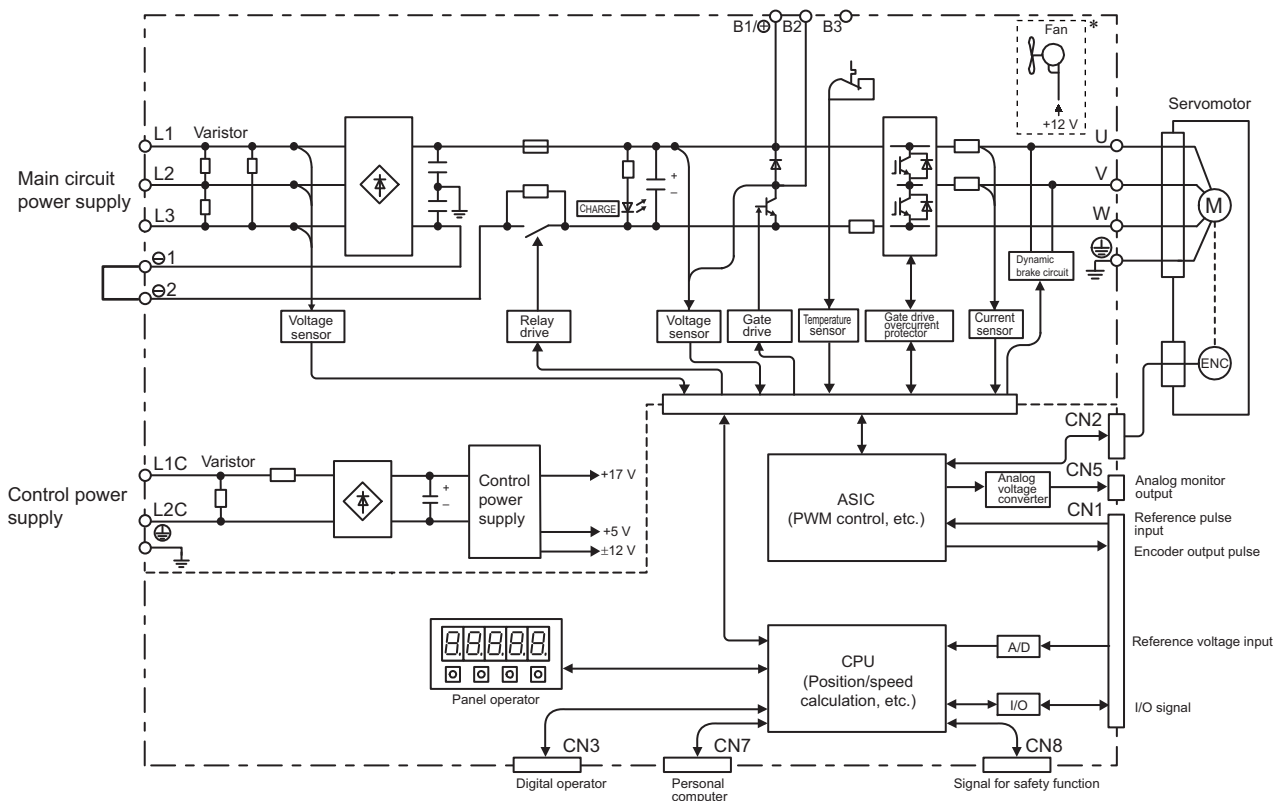

* The following SERVOPACKs do not have cooling fans: SGDV-□□□□□□□□

1.4.5 Three-phase 200 V, SGDV-2R8A01□ Model

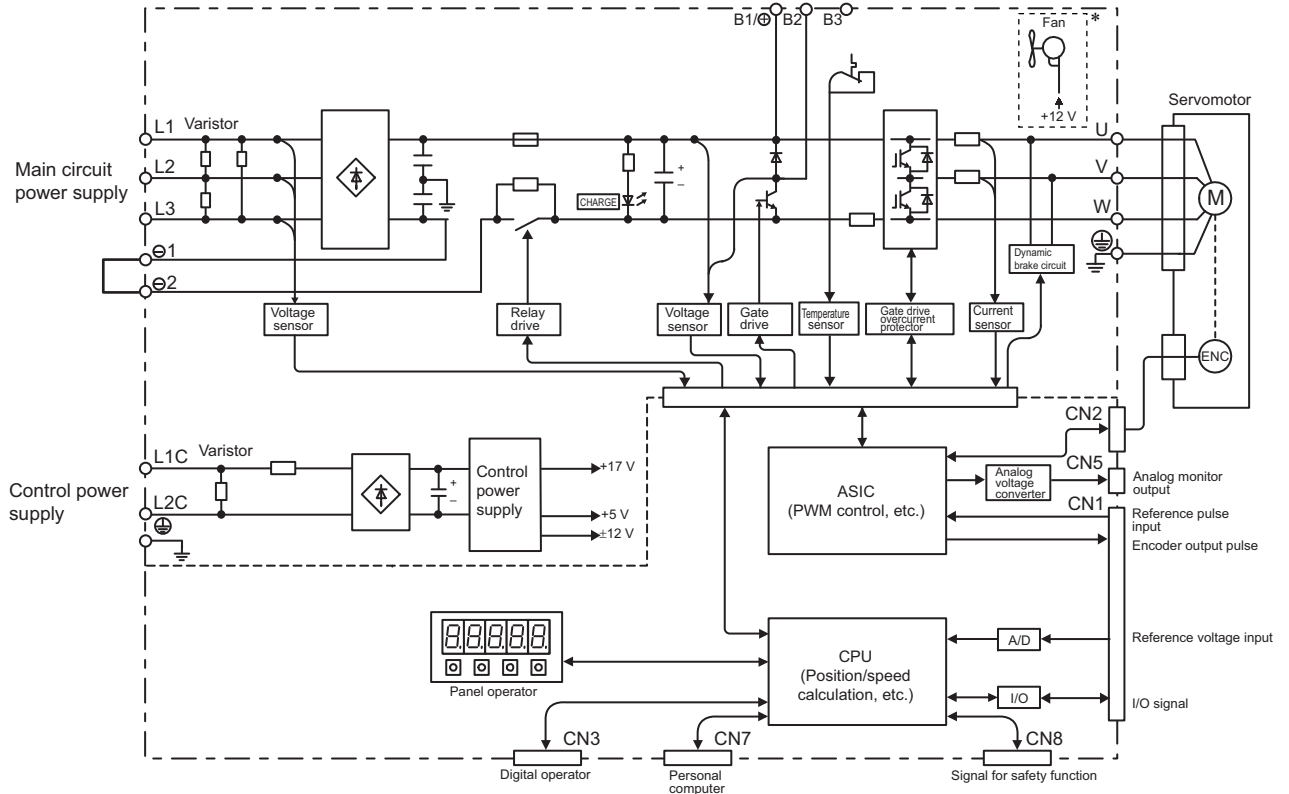

* The following SERVOPACKs do not have cooling fans: SGDV-□□□□□□B

1.4.6 Three-phase 200 V, SGDV-3R8A01A, -5R5A01A, -7R6A01A Models

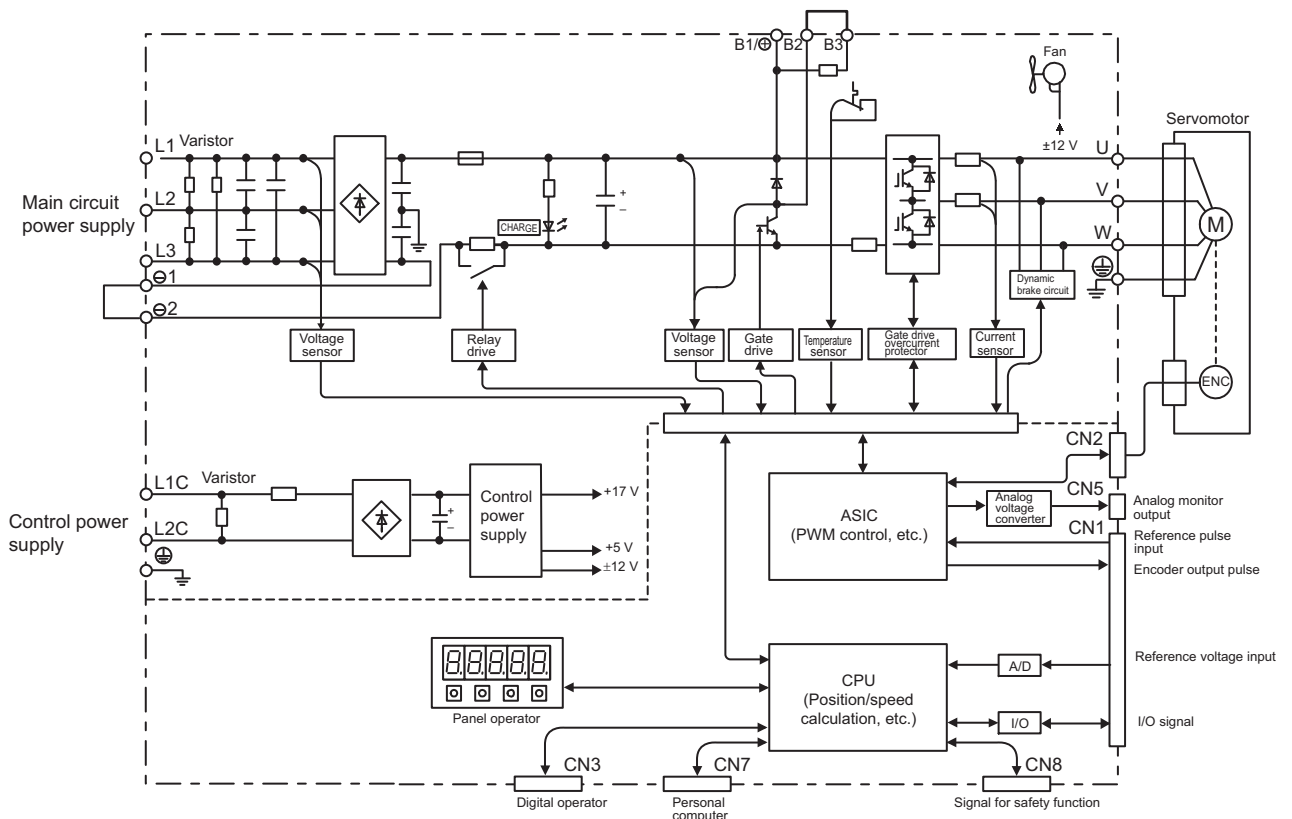

1.4.7 Three-phase 200 V, SGDV-120A01A Model

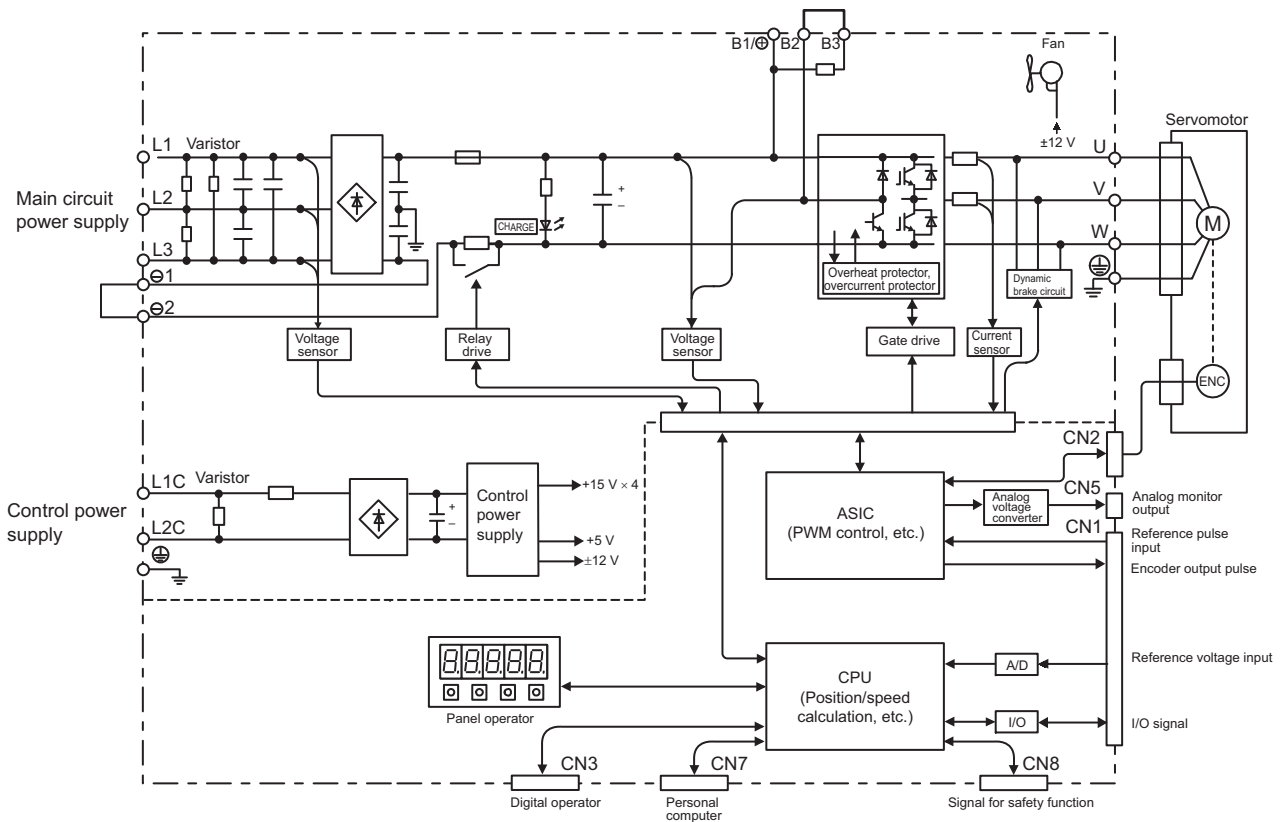

1.4.8 Three-phase 200 V, SGDV-180A01A, -200A01A Models

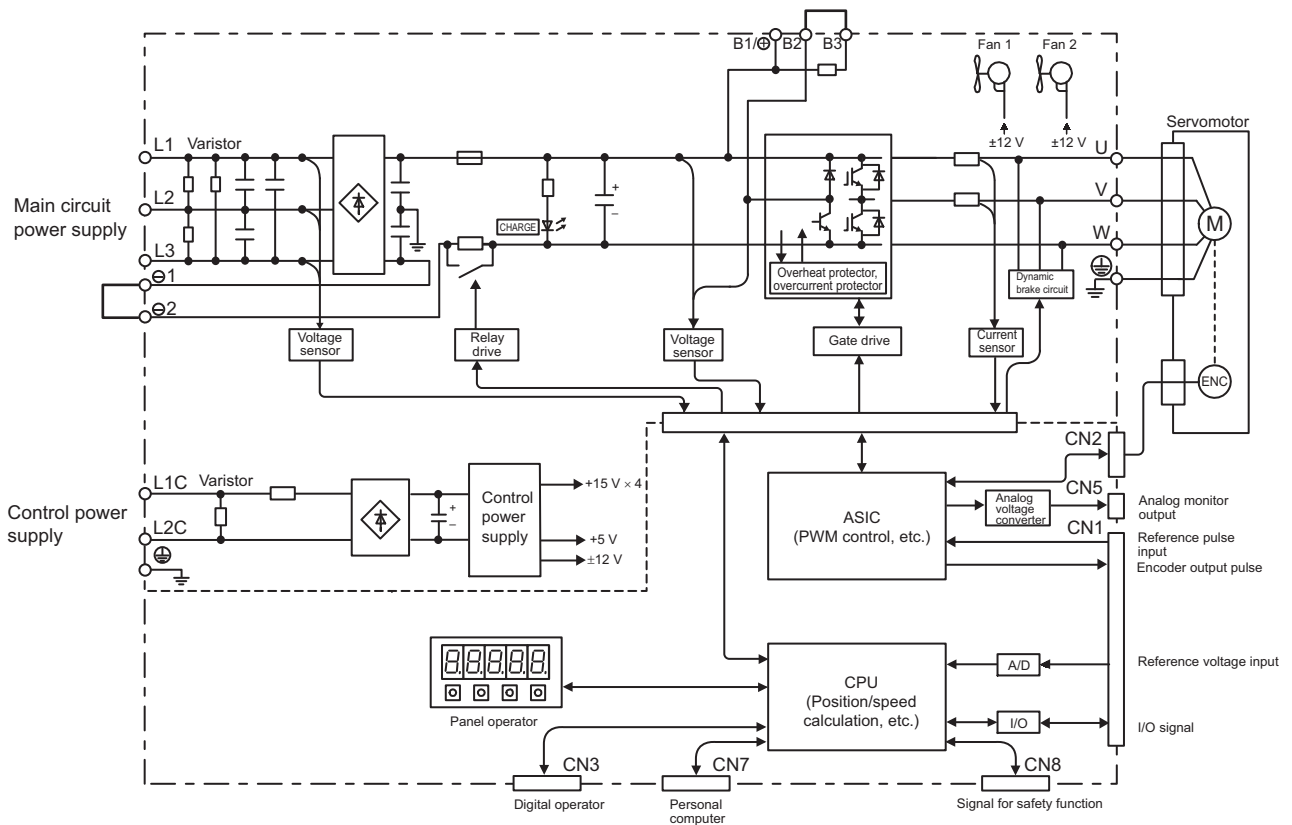

1.4.9 Three-phase 200 V, SGD V-330A01A Model

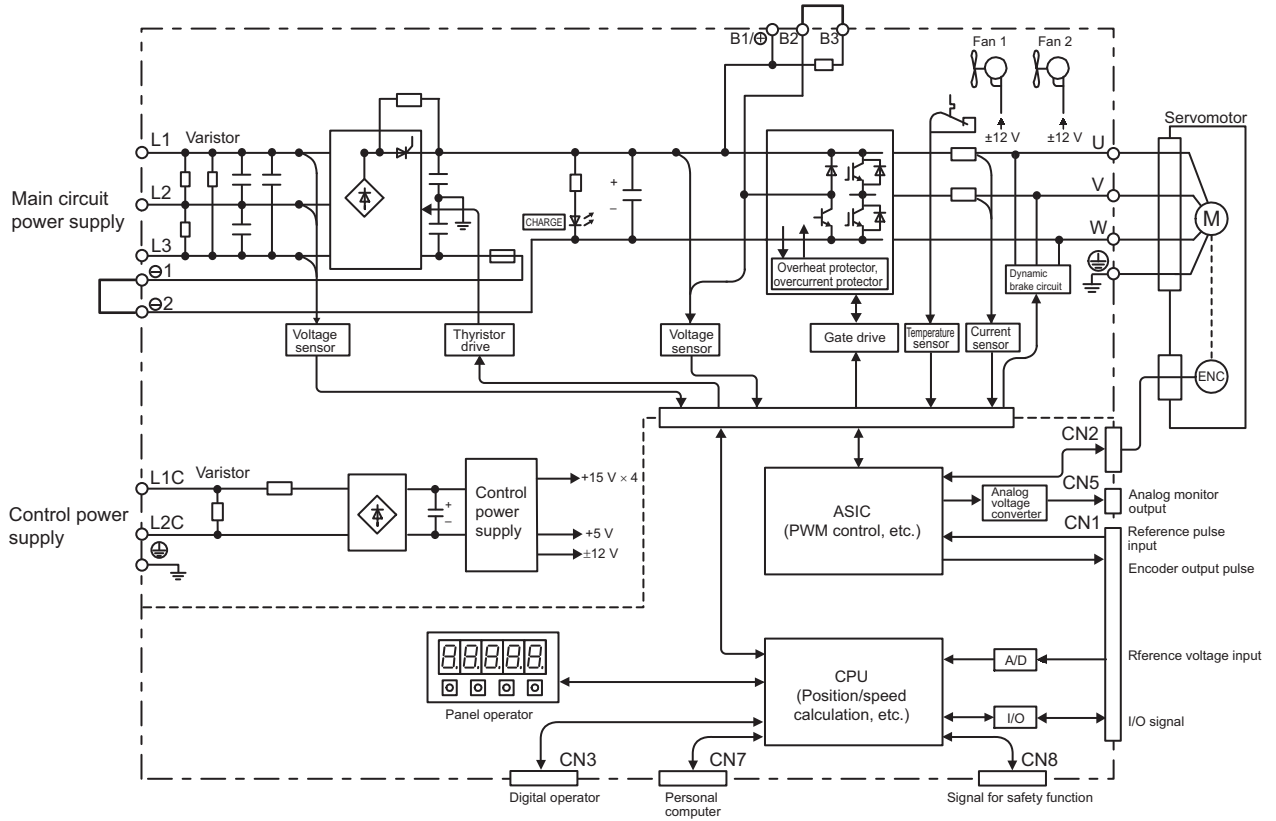

1.4.10 Three-phase 200 V, SGD V-470A01A, -550A01A Models

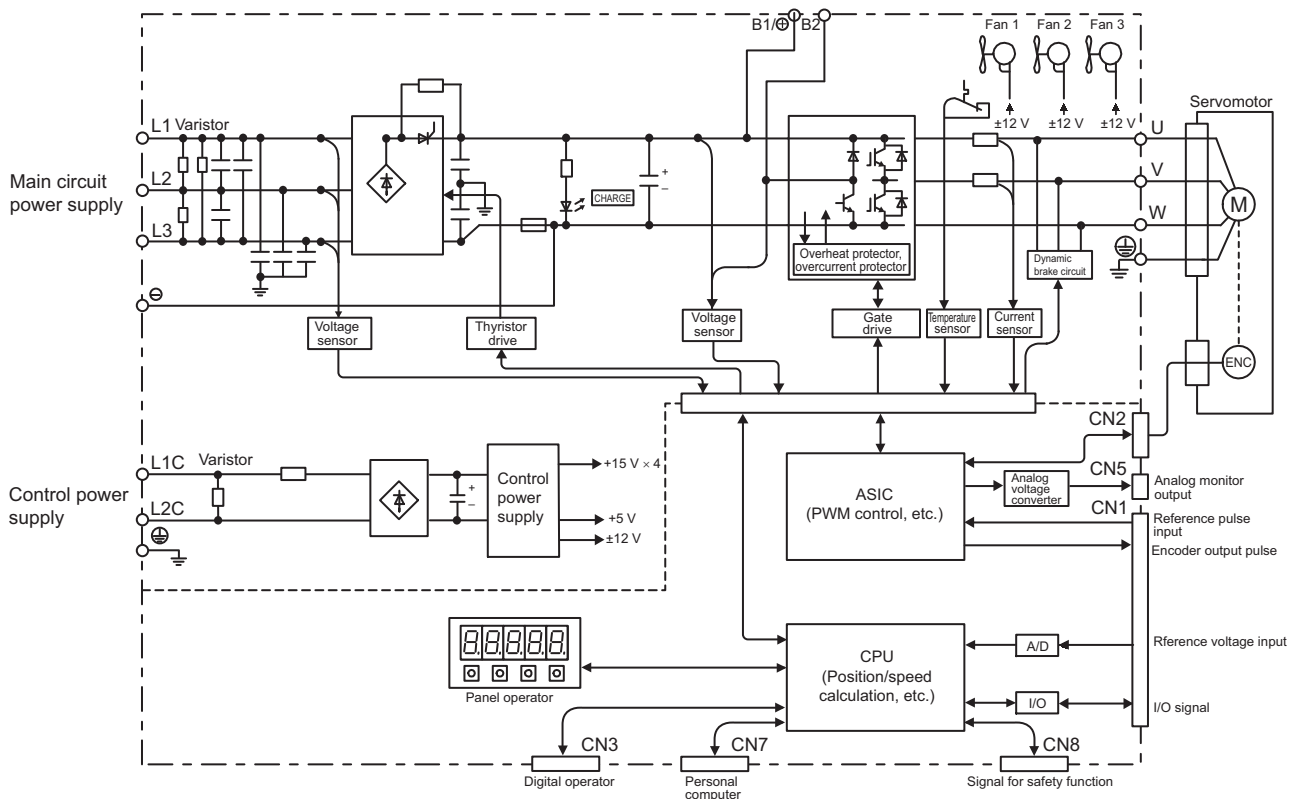

1.4.11 Three-phase 200 V SGDV-590A01A, -780A01A Models

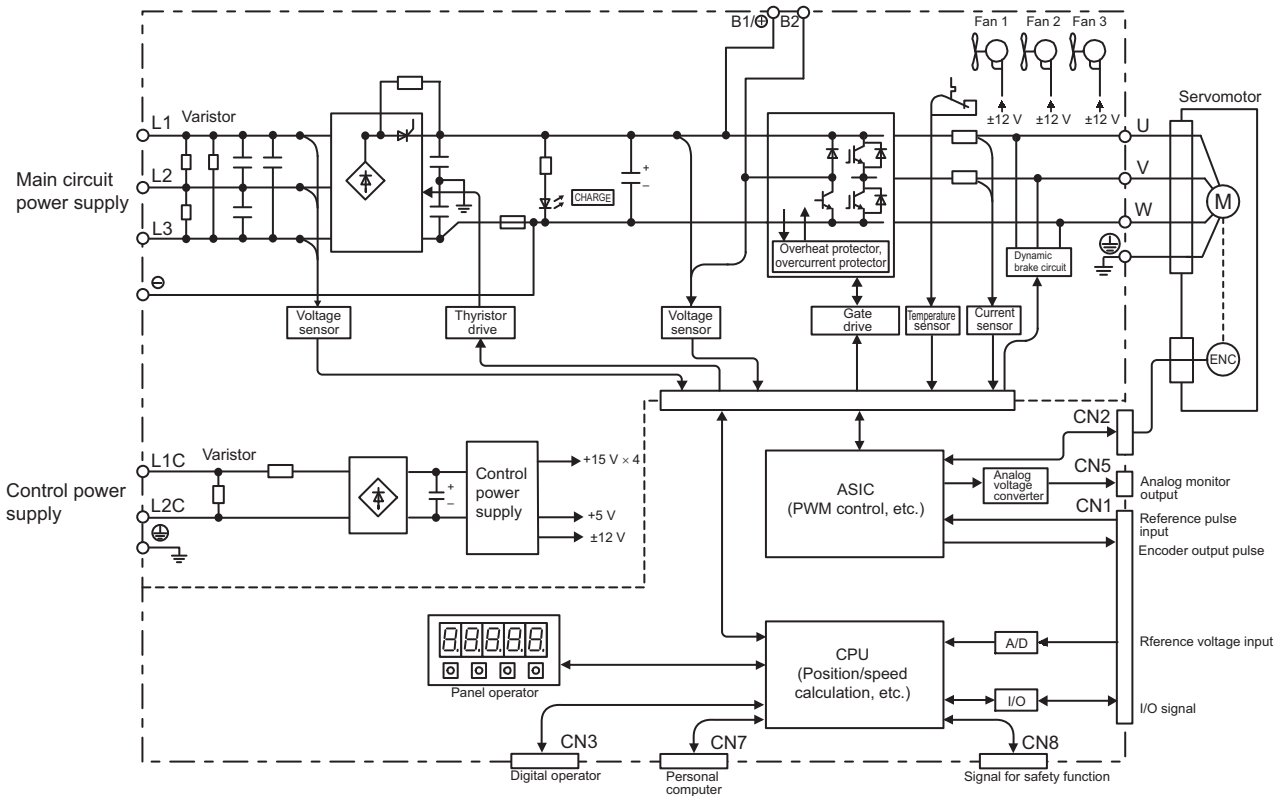

1.4.12 Three-phase 400 V, SGDV-1R9D01A, -3R5D01A, -5R4D01A Models

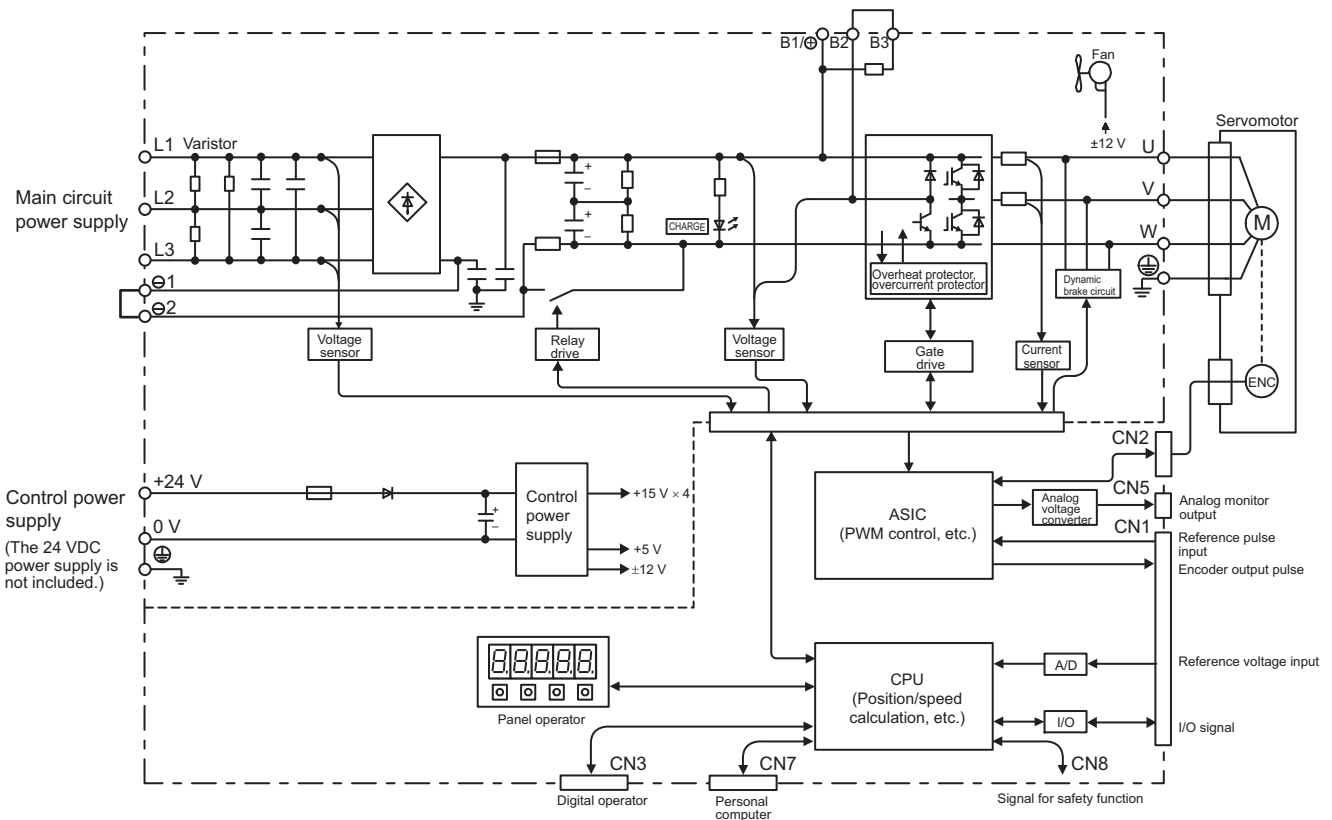

1.4.13 Three-phase 400 V, SGDV-8R4D01A, -120D01A Models

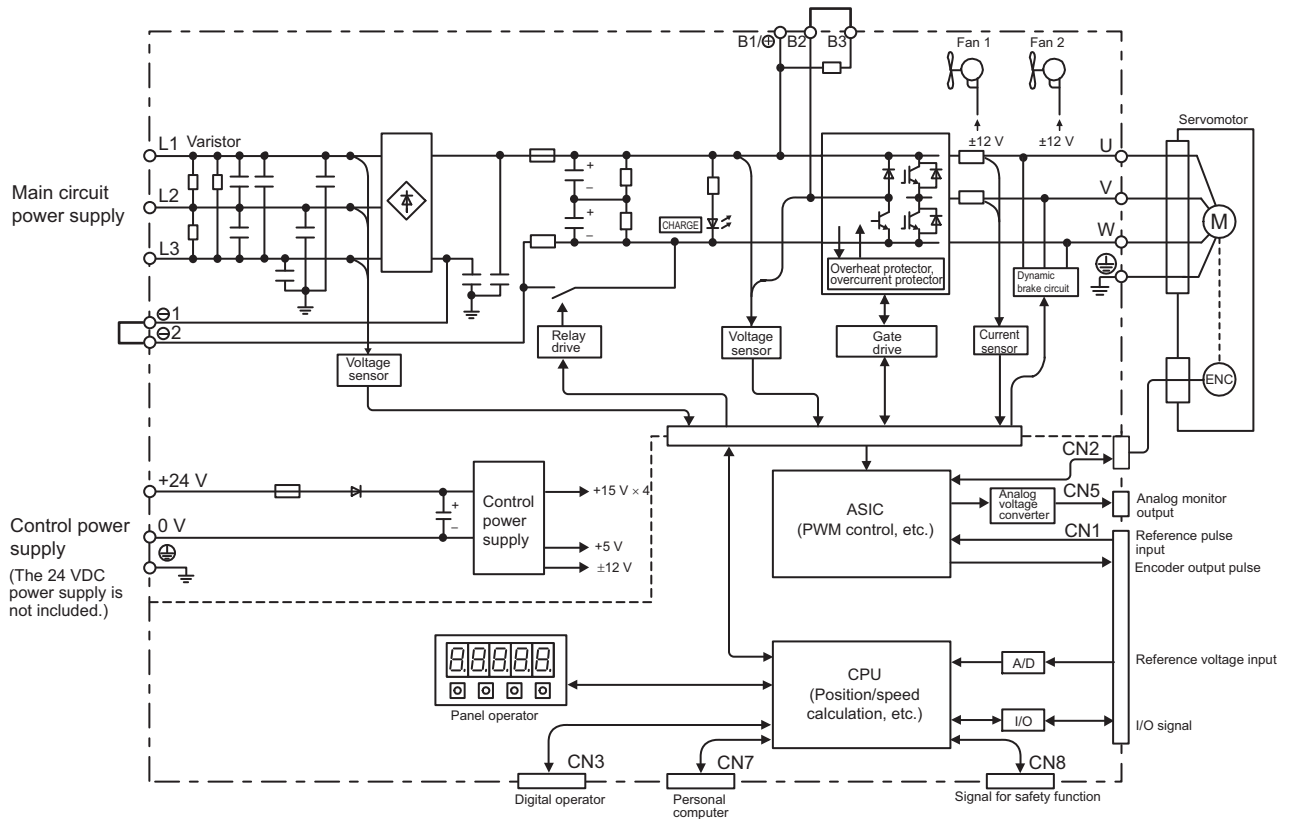

1.4.14 Three-phase 400 V, SGDV-170D01A Model

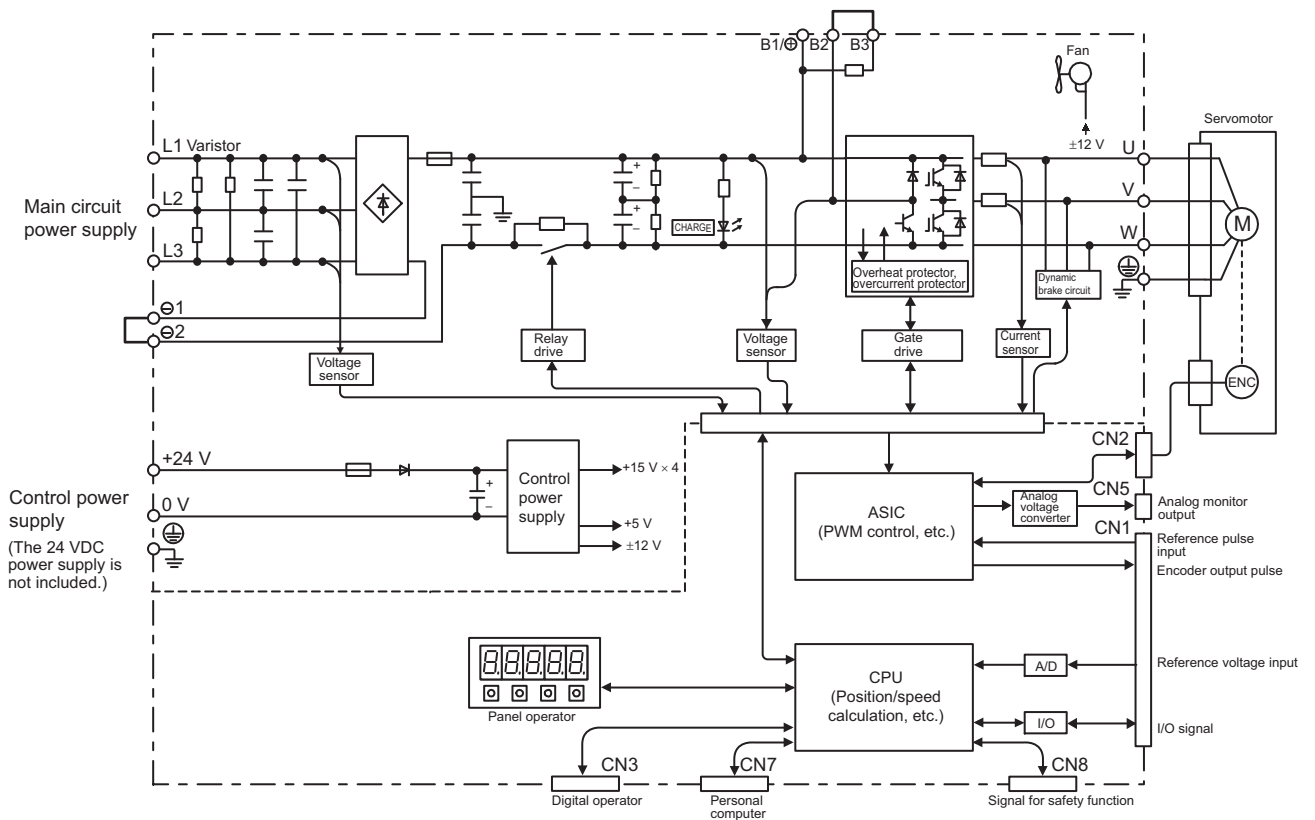

1.4.15 Three-phase 400 V, SGDV-210D01A, -260D01A Models

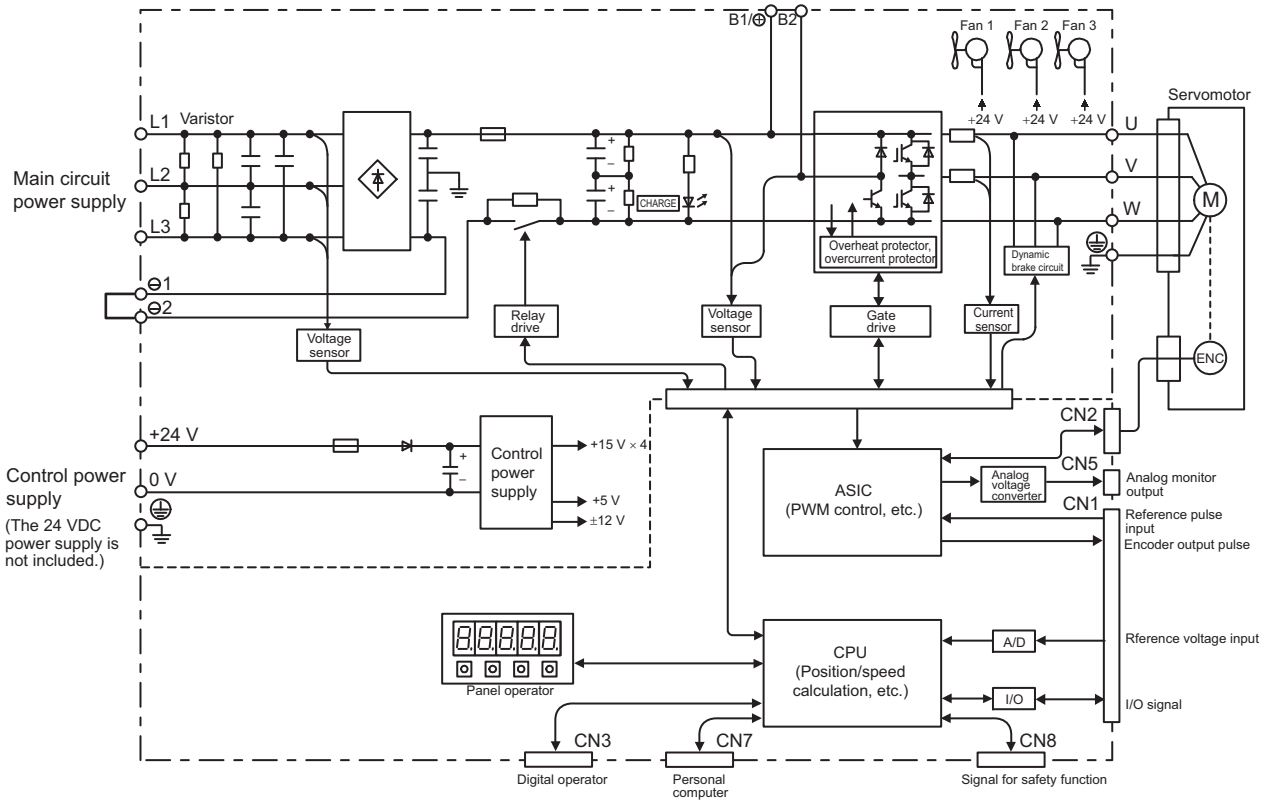

1.4.16 Three-phase 400 V, SGDV-280D01A, -370D01A Models

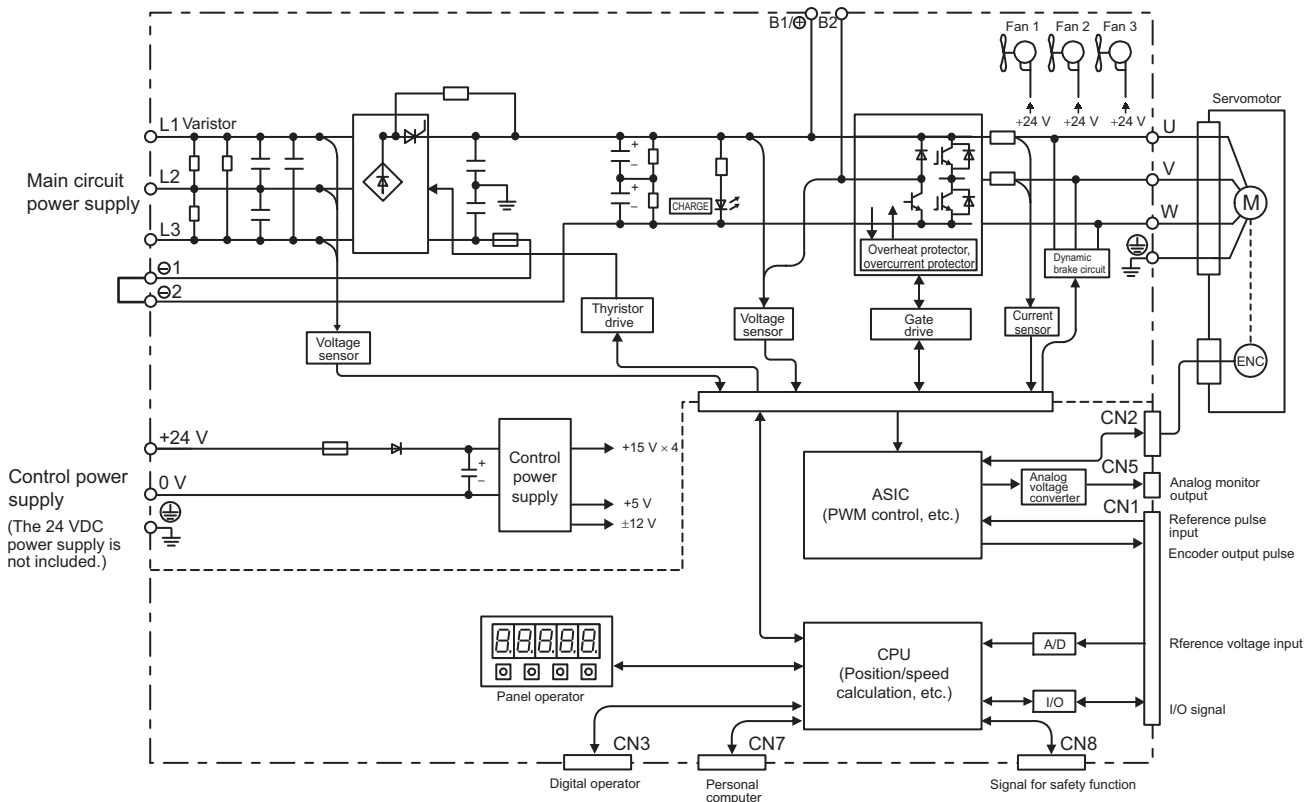

1.5 Examples of Servo System Configurations

This section describes examples of basic servo system configuration.

1.5.1 Connecting to SGDV-□□□F01A SERVOPACK

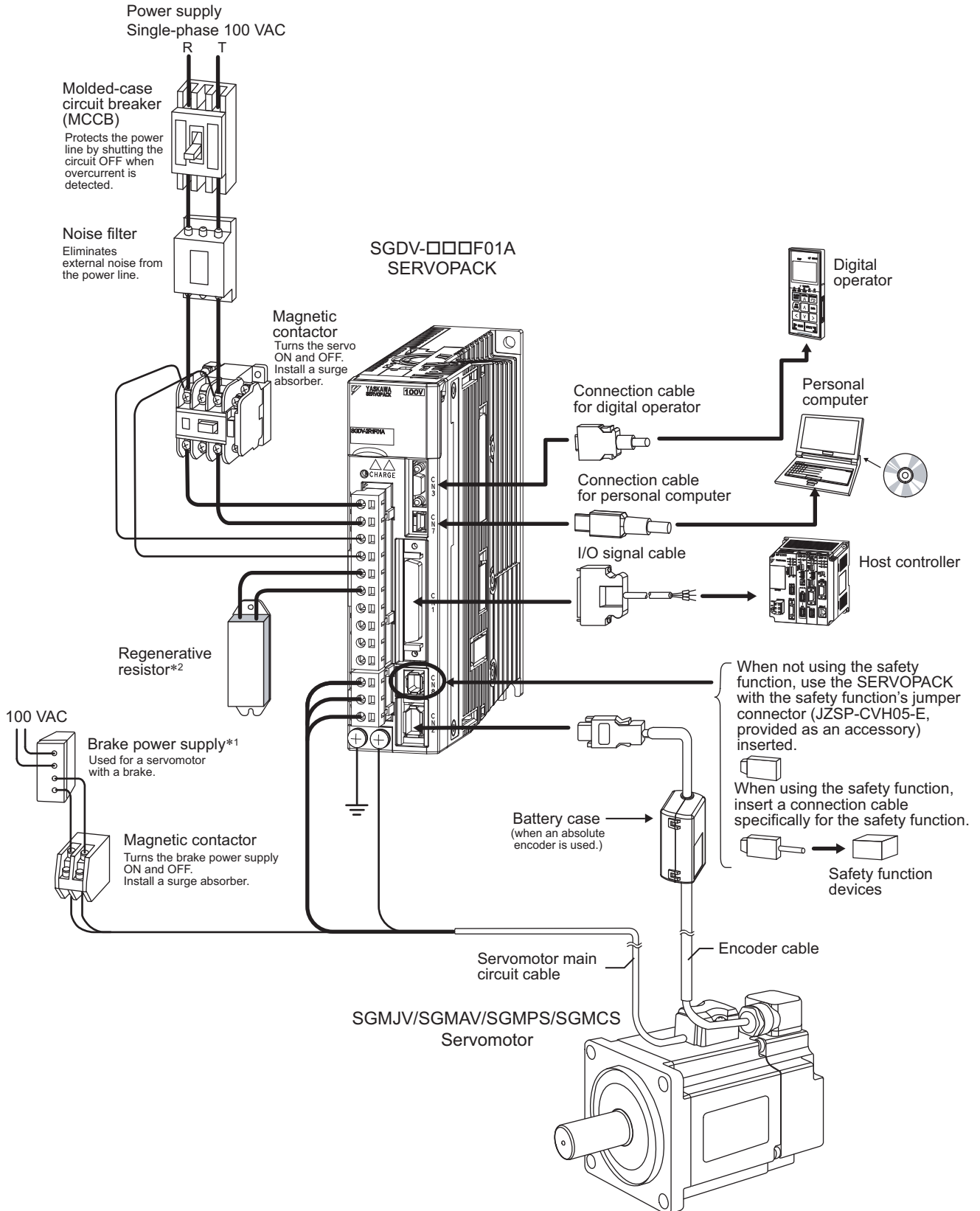

*1. Use a 24-VDC power supply. (Not included.)

*2. Before connecting an external regenerative resistor to the SERVOPACK, refer to 3.6 *Connecting Regenerative Resistors*.

1.5.2 Connecting to SGDV-□□□A01□ SERVOPACK

(1) Using a Three-phase, 200-V Power Supply

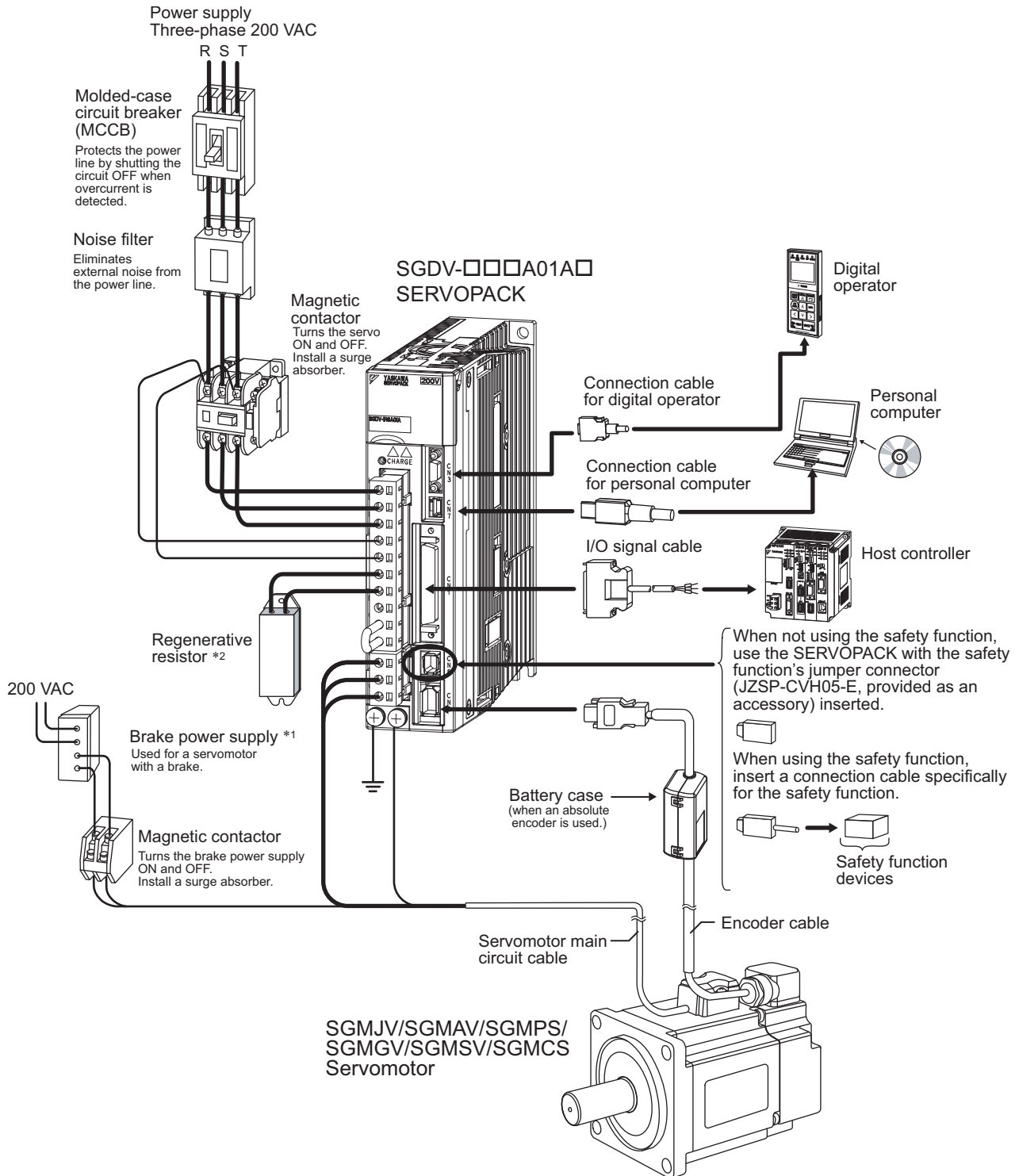

*1. Use a 24-VDC power supply. (Not included.)

If using a 90-VDC power supply for a brake, however, use one of the following power supplies.

- For 200-V input voltage: LPSE-2H01-E
- For 100-V input voltage: LPDE-1H01-E

For details, refer to *Σ-V Series Product Catalog* (No.: KAEP S800000 42).

*2. Before connecting an external regenerative resistor to the SERVOPACK, refer to 3.6 *Connecting Regenerative Resistors*.

(2) Using a Single-phase, 200-V Power Supply

The Σ -V Series 200 V SERVOPACK generally specifies a three-phase power input but some models can be used with a single-phase 200 V power supply. Refer to 3.1.3 *Using the SERVOPACK with Single-phase, 200 V Power Input* for details.

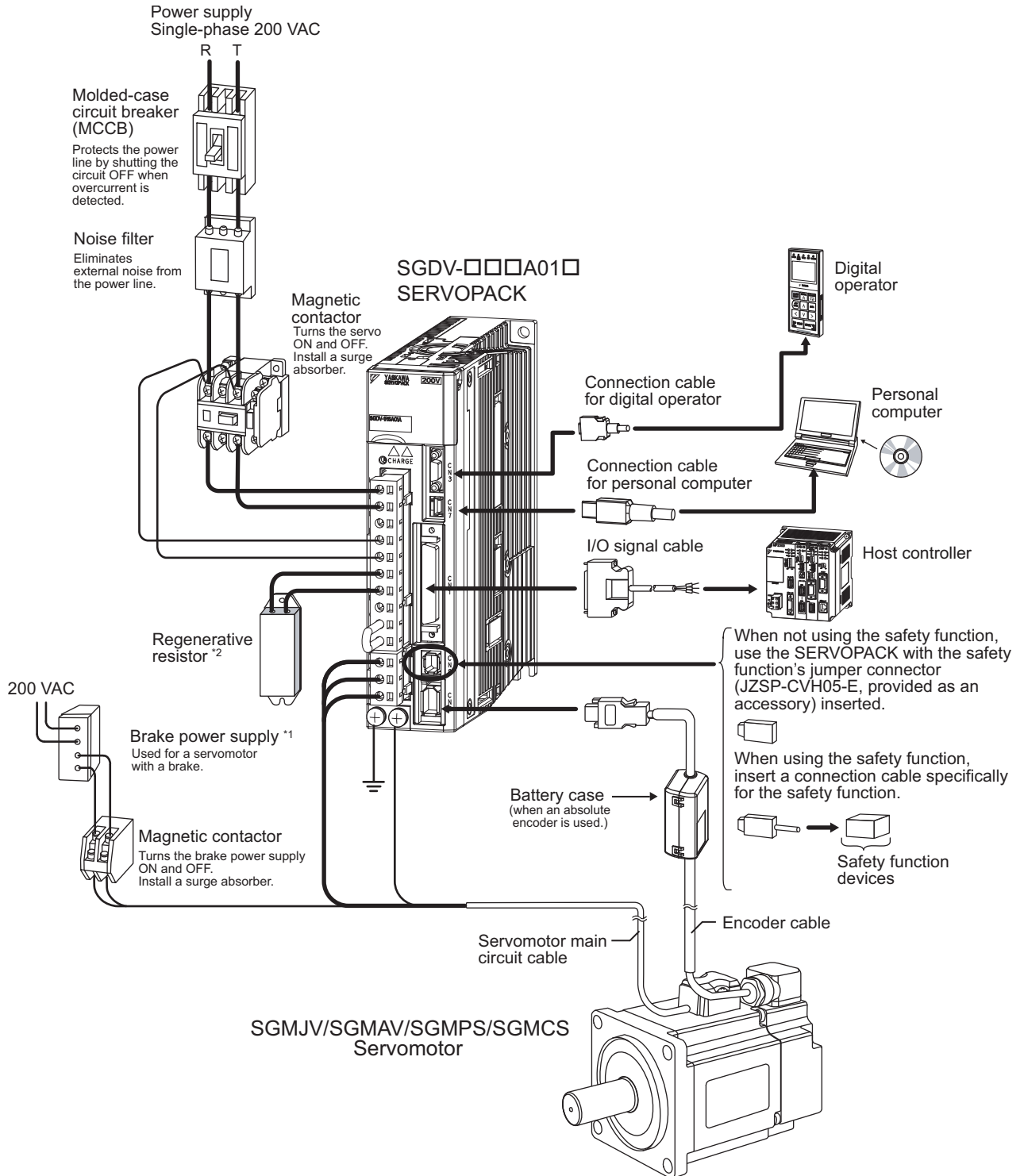

*1. Use a 24-VDC power supply. (Not included.)
 *2. Before connecting an external regenerative resistor to the SERVOPACK, refer to 3.6 *Connecting Regenerative Resistors*.

1.5.3 Connecting to SGDV-□□□D01A SERVOPACK

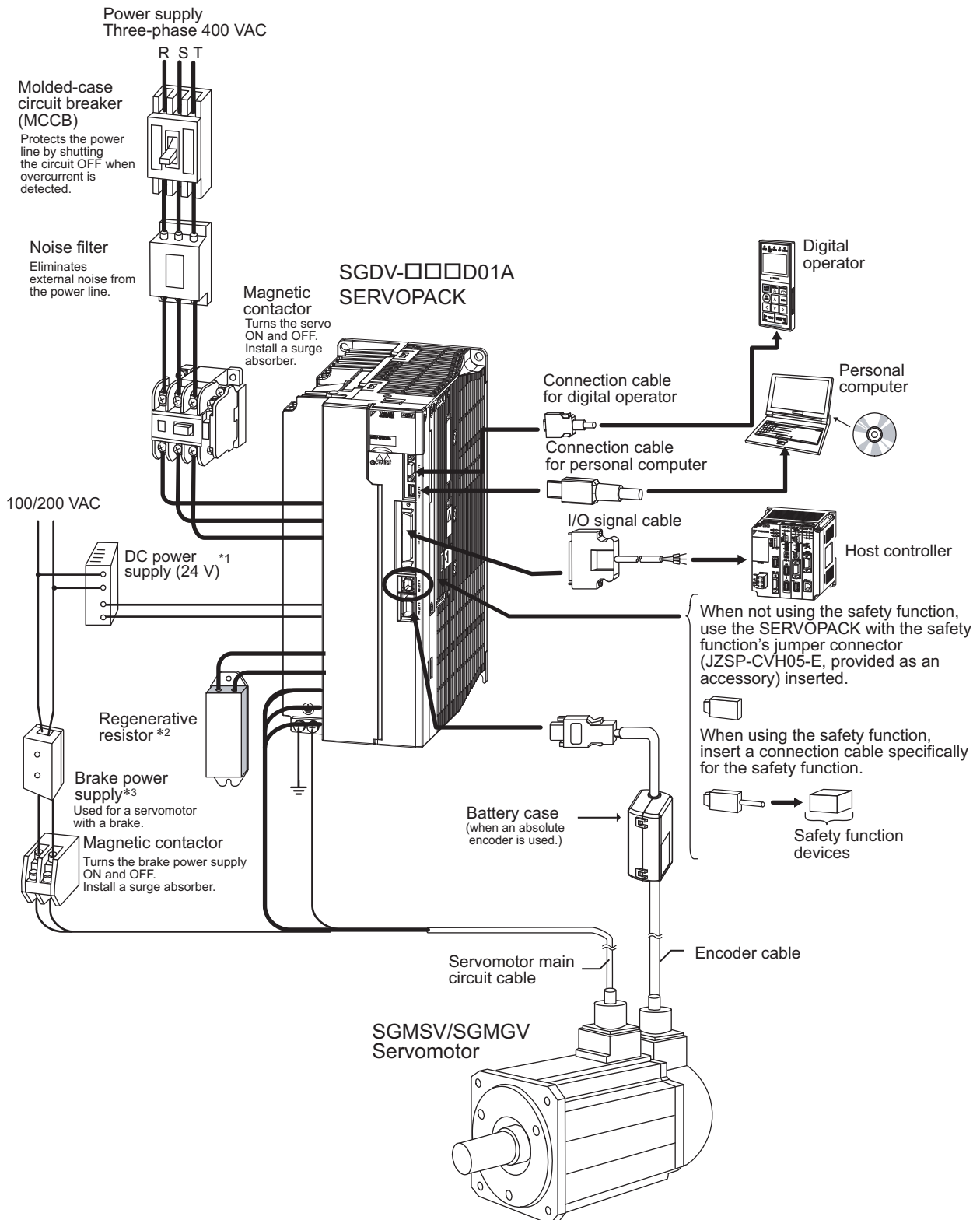

- *1. Use a 24-VDC power supply with double insulation or reinforced insulation. (The 24-VDC power supply is not included.) Do not use the same 24-VDC power supply for the brakes.
- *2. Before connecting an external regenerative resistor to the SERVOPACK, refer to *3.6 Connecting Regenerative Resistors*.
- *3. Use a 24-VDC power supply for a brake. (Not included.)
If using a 90-VDC power supply for a brake, however, use one of the following power supplies.
- For 200-V input voltage: LPSE-2H01-E
 - For 100-V input voltage: LPDE-1H01-E
- For details, refer to *Σ-V Series Product Catalog* (No.: KAEP S800000 42).

1.6 SERVOPACK Model Designation

This section shows SERVOPACK model designation.

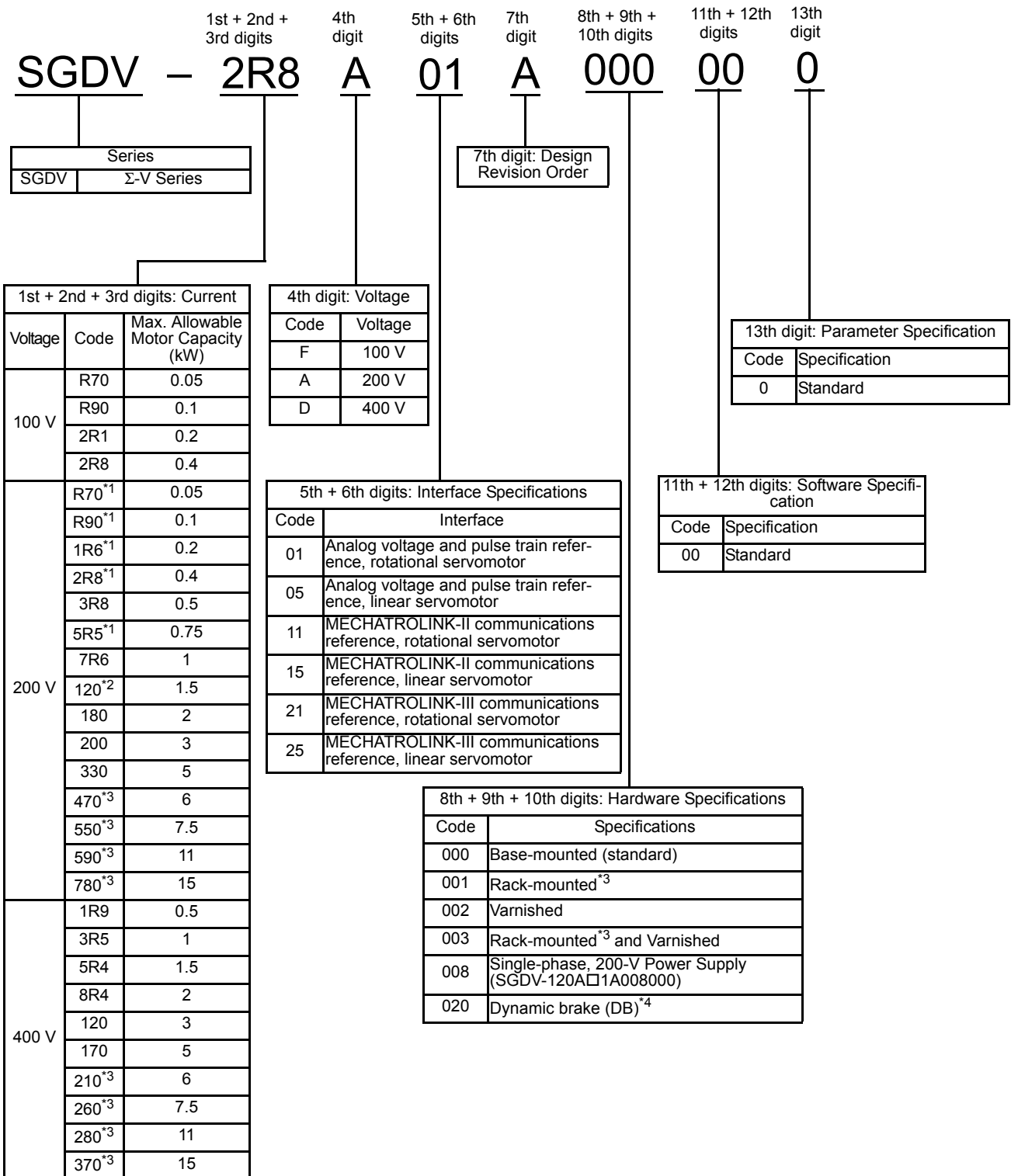

*1. These amplifiers can be powered with single or three-phase.
 *2. SGD V-120A□1A008000, a special version of the 1.5 kW amplifier can be used for single-phase operation.
 *3. SGD V-470A, -550A, -590A, -780A, -210D, -260D, -280D, and -370D are duct-ventilated types.
 *4. A resistor for the dynamic brake is not included. An external resistor for the dynamic brake can only be used with 400-V SERVOPACKs.

Note: If the option codes digits 8 to 13 are all zeros, they are omitted.

1.7 Inspection and Maintenance

This section describes the inspection and maintenance of SERVOPACK.

(1) SERVOPACK Inspection

For inspection and maintenance of the SERVOPACK, follow the inspection procedures in the following table at least once every year. Other routine inspections are not required.

Item	Frequency	Procedure	Comments
Exterior	At least once a year	Check for dust, dirt, and oil on the surfaces.	Clean with compressed air.
Loose Screws		Check for loose terminal block and connector screws.	Tighten any loose screws.

(2) SERVOPACK's Parts Replacement Schedule

The following electric or electronic parts are subject to mechanical wear or deterioration over time. To avoid failure, replace these parts at the frequency indicated.

Refer to the standard replacement period in the following table and contact your Yaskawa representative. After an examination of the part in question, we will determine whether the parts should be replaced or not.

 IMPORTANT	<p>The parameters of any SERVOPACKs overhauled by Yaskawa are reset to the factory settings before shipping. Be sure to confirm that the parameters are properly set before starting operation.</p>
--	---

Part	Standard Replacement Period	Operating Conditions
Cooling Fan	4 to 5 years	<ul style="list-style-type: none"> • Surrounding Air Temperature: Annual average of 30°C • Load Factor: 80% max. • Operation Rate: 20 hours/day max.
Smoothing Capacitor	7 to 8 years	
Other Aluminum Electrolytic Capacitor	5 years	
Relays	–	
Fuses	10 years	

Panel Operator

2.1 Overview	2-2
2.1.1 Names and Functions	2-2
2.1.2 Display Selection	2-2
2.1.3 Status Display	2-3
2.2 Utility Functions (Fn□□□)	2-4
2.3 Parameters (Pn□□□)	2-5
2.3.1 Parameter Classification	2-5
2.3.2 Notation for Parameters	2-5
2.3.3 Setting Parameters	2-6
2.4 Monitor Displays (Un□□□)	2-9

2.1 Overview

2.1.1 Names and Functions

Panel operator consists of display part and keys.

Parameter setting, status display, execution of utility function, and monitoring of the SERVOPACK operation are enabled using the panel operator.

The names and functions of the keys on the panel operator are as follows.

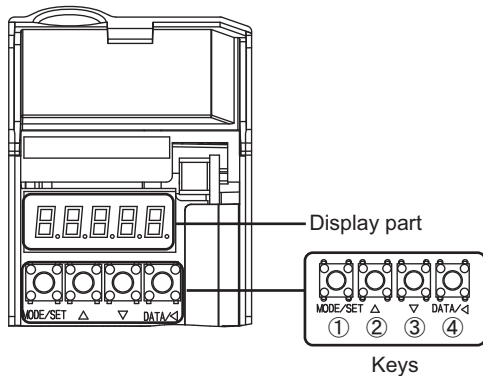

Key No.	Key Name	Function
①	MODE/SET Key	<ul style="list-style-type: none"> To select a display. To set the set value.
②	UP Key	To increase the set value.
③	DOWN Key	To decrease the set value.
④	DATA/SHIFT Key	<ul style="list-style-type: none"> To display the set value by pressing this key for one second. To move to the next digit on the left when flashing.

Note: To reset the servo alarm, press the UP Key and the DOWN Key simultaneously. Be sure to remove the cause and then reset the alarm.

2.1.2 Display Selection

Press the MODE/SET Key to make a selection in the following order.

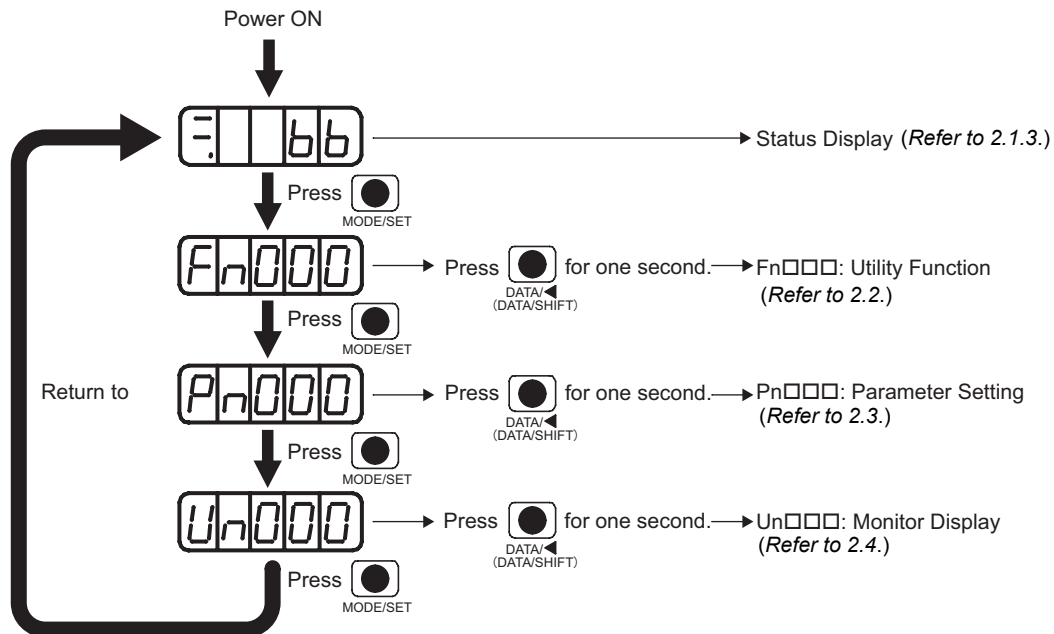

2.1.3 Status Display

The display shows the following status.

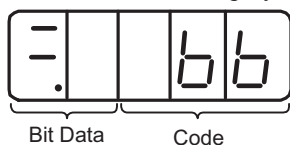

Code	Meaning	Code	Meaning
	Baseblock Servo OFF (servomotor power OFF)		Reverse Run Prohibited N-OT is OFF.
	Run Servo ON (servomotor power ON)		Safety Function The SERVOPACK is baseblocked by the safety function.
	Forward Run Prohibited P-OT is OFF.	(Example: Run Status) Run Status (Displayed alternately) ↓ Test without Motor	Test without Motor Indicates that the test without a motor is in progress. Status displays depend on the status of servomotor and SERVOPACK. Refer to 4.6 <i>Test Without Motor Function</i> for details.
			Alarm Flashes the alarm number.

Display	Meaning
	Control Power ON Lights when SERVOPACK control power is ON.
	Baseblock Lights when the servomotor is OFF.
	In speed control: Speed Coincidence (/V-CMP) Lights when the difference between the servomotor speed and reference speed is the same as or less than the value set in Pn503. (Factory setting: 10 min ⁻¹) * Always lights in torque control. Note: If there is noise in the reference voltage during speed control, the horizontal line (-) at the far left edge of the panel operator display may flash. Refer to 3.7.1 <i>Wiring for Noise Control</i> and take a preventive measures. In position control: Positioning Completion (/COIN) Lights if error between position reference and actual motor position is less than the value set in Pn522. (Factory setting: 7 reference units)
	Rotation Detection (/TGON) Lights if motor speed exceeds the value set in Pn502. (Factory setting: 20 min ⁻¹)
	In speed control: Speed Reference Input Lights if input speed reference exceeds the value set in Pn502. (Factory setting: 20 min ⁻¹) In position control: Reference Pulse Input Lights if reference pulse is input.
	In torque control: Torque Reference Input Lights if input torque reference exceeds preset value (10% of the rated torque). In position control: Clear Signal Input Lights when clear signal is input.
	Power Ready Lights when main circuit power supply is ON.

2.2 Utility Functions (Fn□□□)

The utility functions are related to the setup and adjustment of the SERVOPACK.

In this case, the panel operator displays numbers beginning with Fn.



Display Example for Origin Search

The following table outlines the procedures necessary for an origin search (Fn003).

Step	Display after Operation	Keys	Operation									
1			Press the MODE/SET Key to select the utility function.									
2			Press the UP or DOWN Key to select Fn003.									
3			Press the DATA/SHIFT Key for approximately one second, and the display shown on the left appears.									
4			Press the MODE/SET Key to turn the servomotor power ON. The display shown on the left appears.									
5			<p>Pressing the UP Key will rotate the servomotor in the forward direction. Pressing the DOWN Key will rotate the servomotor in the reverse direction. The rotation direction of the servomotor changes according to the setting of Pn000.0 as shown in the following table.</p> <table border="1"> <thead> <tr> <th>Parameter</th> <th>UP Key</th> <th>DOWN Key</th> </tr> </thead> <tbody> <tr> <td>Pn000 n.□□□0</td> <td>CCW</td> <td>CW</td> </tr> <tr> <td>Pn000 n.□□□1</td> <td>CW</td> <td>CCW</td> </tr> </tbody> </table> <p>Note: Direction when viewed from the load of the servomotor.</p>	Parameter	UP Key	DOWN Key	Pn000 n.□□□0	CCW	CW	Pn000 n.□□□1	CW	CCW
Parameter	UP Key	DOWN Key										
Pn000 n.□□□0	CCW	CW										
Pn000 n.□□□1	CW	CCW										
6	 Display flashes.		When the servomotor origin search is completed, the display flashes. At this moment, the servomotor is servo-locked at the origin pulse position.									
7			Press the DATA/SHIFT Key for approximately one second. "Fn003" is displayed again.									
8	To enable the change in the setting, turn the power OFF and ON again.											

2.3 Parameters (Pn□□□)

This section describes the classifications, methods of notation, and settings for parameters given in this manual.

2.3.1 Parameter Classification

Parameters of the Σ -V Series SERVOPACK are classified into two types of parameters. One type of parameters is required for setting up the basic conditions for operation and the other type is required for tuning parameters that are required to adjust servomotor characteristics.

Classification	Meaning	Display Method	Setting Method
Setup Parameters	Parameters required for setup.	Always displayed (Factory setting: Pn00B.0 = 0)	Set each parameter individually.
Tuning Parameters	Parameters for tuning control gain and other parameters.	Set Pn00B.0 to 1.	There is no need to set each parameter individually.

There are two types of notation used for parameters, one for parameter that requires a value setting (parameter for numeric settings) and one for parameter that requires the selection of a function (parameter for selecting functions).

The notation and settings for both types of parameters are described next.

2.3.2 Notation for Parameters

(1) Parameters for Numeric Settings

The control methods for which the parameters applies.
 Speed : Speed control Position : Position control Torque : Torque control

Pn406	Emergency Stop Torque				
			<input type="checkbox"/> Speed	<input type="checkbox"/> Position	<input type="checkbox"/> Torque
	Setting Range	Setting Unit	Factory Setting	When Enabled	Classification
0% to 800%	1%	800	After change	Setup	

Parameter number

Indicates the setting range for the parameter.

Indicates the minimum setting unit for the parameter.

Indicates the parameter setting before shipment.

Indicates when a change to the parameter will be effective.

Indicates the parameter classification.

(2) Parameters for Selecting Functions

Parameter	Meaning	When Enabled	Classification
Pn002	n.□□□□ [Factory setting]	Uses the absolute encoder as an absolute encoder.	After restart
	n.□1□□	Uses the absolute encoder as an incremental encoder.	

Parameter number

The notation "n.□□□□" indicates a parameter for selecting functions. Each □ corresponds to the setting value of that digit. The notation shown here means that the third digit is 1.

This section explains the selections for the function.

• Notation Example

Panel Operator Display (Display Example for Pn002)

	Digit Notation		Setting Notation	
	Notation	Meaning	Notation	Meaning
1st digit	Pn002.0	Indicates the value for the 1st digit of parameter Pn002.	Pn002.0 = x or n.□□□x	Indicates that the value for the 1st digit of parameter Pn002 is x.
2nd digit	Pn002.1	Indicates the value for the 2nd digit of parameter Pn002.	Pn002.1 = x or n.□□x□	Indicates that the value for the 2nd digit of parameter Pn002 is x.
3rd digit	Pn002.2	Indicates the value for the 3rd digit of parameter Pn002.	Pn002.2 = x or n.□x□□	Indicates that the value for the 3rd digit of parameter Pn002 is x.
4th digit	Pn002.3	Indicates the value for the 4th digit of parameter Pn002.	Pn002.3 = x or n.x□□□	Indicates that the value for the 4th digit of parameter Pn002 is x.

2.3.3 Setting Parameters

(1) How to Make Numeric Settings Using Parameters

This section describes how to make numeric settings using parameters.

■ Parameters with Setting Ranges of Up to Five Digits

The example below shows how to change the speed loop gain (Pn100) from "40.0" to "100.0."

Step	Display after Operation	Keys	Operation
1			Press the MODE/SET Key to select the parameter setting. If Pn100 is not displayed, press the UP or the DOWN Key to select Pn100.
2			Press the DATA/SHIFT Key for approximately one second. The current data of Pn100 is displayed.
3			Press the DATA/SHIFT Key to select "4". "4" will flash and be able to be changed.
4			Keep pressing the UP Key until "0100.0" is displayed.
5	 Display flashes.		Press the MODE/SET Key. The value flashes and is saved. The data for the speed loop gain (Pn100) is changed from "40.0" to "100.0."
6			Press the DATA/SHIFT Key for approximately one second. "Pn100" is displayed again.

■ Parameters with Setting Ranges of Six Digits or More

Panel operator displays five digits. When the parameter number is more than six digits, values are displayed and set as shown below.

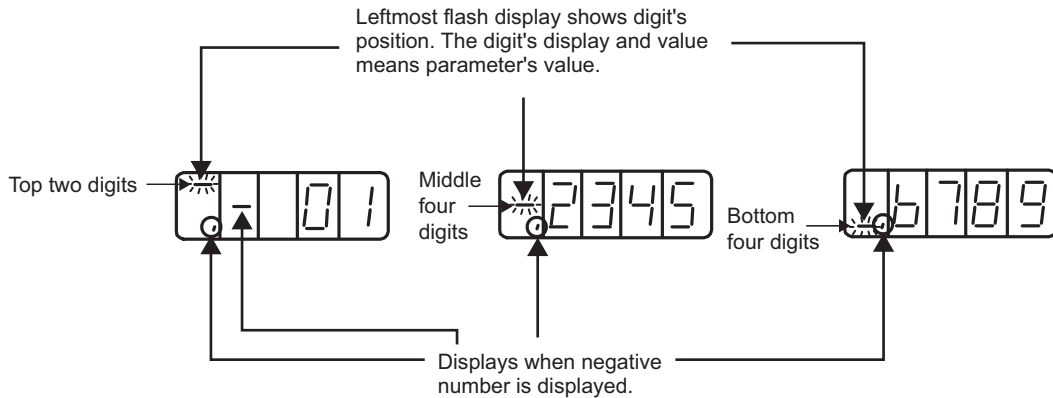

The example below shows how to set the positioning completed width (Pn522) to "0123456789."

Step	Display after Operation	Keys	Operation
1			Press the MODE/SET Key to select the parameter setting. If Pn522 is not displayed, press the DATA/SHIFT Key, the UP Key, or the DOWN Key to select Pn522.
2	<p>Before changing bottom four digits</p> <p>↓</p> <p>After changing bottom four digits</p>		<p>Press the DATA/SHIFT Key for approximately one second. The current data for bottom four digits of Pn522 are displayed. (In this case, "0007" is displayed.)</p> <p>Press the DATA/SHIFT Key to move to other digits, and change the value by pressing the UP/DOWN Key. (In this case, "6789" is set.)</p>
3	<p>Before changing middle four digits</p> <p>↓</p> <p>After changing middle four digits</p>		<p>Press the DATA/SHIFT Key. The middle four digits will be displayed. (In this case, "0000" is displayed.)</p> <p>Press the DATA/SHIFT Key to move to other digits, and change the value by pressing the UP/DOWN Key. (In this case, "2345" is set.)</p>
4	<p>Before changing top two digits</p> <p>↓</p> <p>After changing top two digits</p>		<p>Press the DATA/SHIFT Key. The top two digits will be displayed. (In this case, "00" is displayed.)</p> <p>Press the DATA/SHIFT Key to move to other digit, and change the value by pressing the UP/DOWN Key. (In this case, "01" is set.)</p> <p>The value "0123456789" is set.</p>

(cont'd)

Step	Display after Operation	Keys	Operation
5			<p>Press the MODE/SET Key to save the value to the SERVOPACK. During saving, top two digits flash. After the saving is completed, press the DATA/SHIFT Key for approximately one second. "Pn522" is displayed again.</p>

<Note>

Setting negative numbers

- For the parameters that accept a negative value setting, display "000000000" and then press the DOWN Key to set negative numbers.
- When setting negative numbers, the value increases by pressing the DOWN Key and decreases by pressing the UP Key.
- Press the DATA/SHIFT Key to move to other digits.
- A - (minus) sign is displayed when the top two digits are displayed.

(2) How to Select Functions Using Parameters

The parameter setting for selecting functions is used to select and set the function allocated to each digit displayed on the panel operator.

The example below shows how to change the setting of Pn000.1 (control method selection) of the Pn000 (basic function select switch 0) from speed control to position control.

Step	Display after Operation	Keys	Operation
1			<p>Press the MODE/SET Key to select the parameter setting. If Pn000 is not displayed, press the UP or the DOWN Key to select Pn000.</p>
2			<p>Press the DATA/SHIFT Key for approximately one second. The current data of Pn000 is displayed.</p>
3			<p>Press the DATA/SHIFT Key once to select the second digit of current data. "0" on the second digit will flash and be able to be changed.</p>
4			<p>Press the UP Key once to change to "n.0010." (Set the control method to position control.)</p>
5			<p>Press the MODE/SET Key. The value flashes and is saved. The control method is changed from speed control to position control.</p>
6			<p>Press the DATA/SHIFT Key for approximately one second. "Pn000" is displayed again.</p>
7	<p>To enable the change in the setting, turn the power OFF and ON again.</p>		

2.4 Monitor Displays (Un□□□)

The monitor displays can be used for monitoring the reference values, I/O signal status, and SERVOPACK internal status.

For details, refer to 8.2 *Viewing Monitor Displays*.

The panel operator displays numbers beginning with Un.



Display Example for Motor Rotating Speed

The following table outlines the procedures necessary to view the motor rotating speed (Un000).

Step	Display after Operation	Keys	Operation
1			Press the MODE/SET Key to select the monitor display.
2			If Un000 is not displayed, press the UP or the DOWN Key to select Un000.
3			Press the DATA/SHIFT Key for approximately one second to display the data of Un000.
4			Press the DATA/SHIFT Key for approximately one second to return to the display of monitor number (step 1).

Wiring and Connection

3.1	Main Circuit Wiring	3-2
3.1.1	Main Circuit Terminals	3-2
3.1.2	Using a Standard Power Supply (Single-phase 100 V, Three-phase 200 V, or Three-phase 400 V)	3-3
3.1.3	Using the SERVOPACK with Single-phase, 200 V Power Input	3-11
3.1.4	Using the SERVOPACK with a DC Power Input	3-15
3.1.5	Using More Than One SERVOPACK	3-17
3.1.6	General Precautions for Wiring	3-18
3.2	I/O Signal Connections	3-19
3.2.1	I/O Signal (CN1) Names and Functions	3-19
3.2.2	Safety Function Signal (CN8) Names and Functions	3-21
3.2.3	Example of I/O Signal Connections in Speed Control	3-22
3.2.4	Example of I/O Signal Connections in Position Control	3-23
3.2.5	Example of I/O Signal Connections in Torque Control	3-24
3.3	I/O Signal Allocations	3-25
3.3.1	Input Signal Allocations	3-25
3.3.2	Output Signal Allocations	3-29
3.4	Examples of Connection to Host Controller	3-33
3.4.1	Reference Input Circuit	3-33
3.4.2	Sequence Input Circuit	3-35
3.4.3	Sequence Output Circuit	3-37
3.5	Encoder Connection	3-39
3.5.1	Encoder Signal (CN2) Names and Functions	3-39
3.5.2	Encoder Connection Examples	3-39
3.6	Connecting Regenerative Resistors	3-41
3.6.1	Connecting Regenerative Resistors	3-41
3.6.2	Setting Regenerative Resistor Capacity	3-43
3.7	Noise Control and Measures for Harmonic Suppression	3-44
3.7.1	Wiring for Noise Control	3-44
3.7.2	Precautions on Connecting Noise Filter	3-46
3.7.3	Connecting a Reactor for Harmonic Suppression	3-47

3.1 Main Circuit Wiring

The names and specifications of the main circuit terminals are given below.

Also this section describes the general precautions for wiring and precautions under special environments.

3.1.1 Main Circuit Terminals

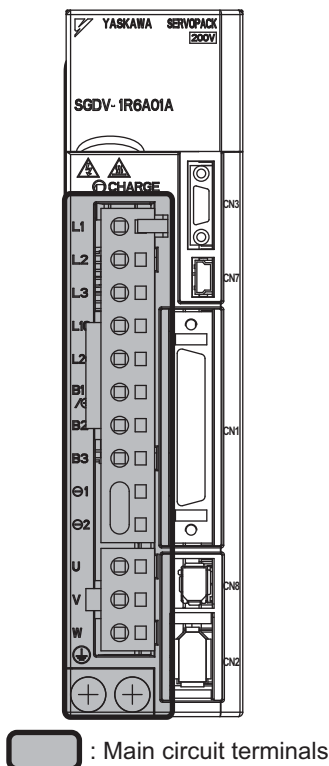

Terminal Symbols	Name	Model SGD V-□□□□	Specification
L1, L2	Main circuit power input terminals	□□□F	Single-phase 100 to 115 V, +10% to -15% (50/60 Hz)
L1, L2, L3		□□□A	Three-phase 200 to 230 V, +10% to -15% (50/60 Hz)
		□□□D	Three-phase 380 to 480 V, +10% to -15% (50/60 Hz)
L1C, L2C	Control power input terminals	□□□F	Single-phase 100 to 115 V, +10% to -15% (50/60 Hz)
24V, 0V		□□□A	Single-phase 200 to 230 V, +10% to -15% (50/60 Hz)
		□□□D	24 VDC, ±15%
B1/⊕, B2*1	External regenerative resistor connection terminals	R70F, R90F, 2R1F, 2R8F, R70A, R90A, 1R6A, 2R8A	If the regenerative capacity is insufficient, connect an external regenerative resistor between B1/⊕ and B2. Note: The external regenerative resistor is not included.
		3R8A, 5R5A, 7R6A, 120A, 180A, 200A, 330A, 1R9D, 3R5D, 5R4D, 8R4D, 120D, 170D	If the internal regenerative resistor is insufficient, remove the lead or shorting bar between B2 and B3 and connect an external regenerative resistor between B1/⊕ and B2. Note: The external regenerative resistor is not included.
		470A, 550A, 590A, 780A, 210D, 260D, 280D, 370D	Connect a regenerative resistor unit between B1/⊕ and B2. Note: The regenerative resistor unit is not included.

(cont'd)

Terminal Symbols	Name	Model SGD V-□□□□	Specification
⊖1, ⊖2*2	DC reactor connection terminal for power supply harmonic suppression	□□□A □□□D	If a countermeasure against power supply harmonic waves is needed, connect a DC reactor between ⊖1 and ⊖2.
B1/⊕	Main circuit positive terminal	□□□A □□□D	Use when DC power supply input is used.
⊖2 or ⊖	Main circuit negative terminal	□□□A □□□D	
U, V, W	Servomotor connection terminals	Use for connecting to the servomotor.	
⊕	Ground terminals (× 2)	Use for connecting the power supply ground terminal and servomotor ground terminal.	

*1. Do not short-circuit between B1/⊕ and B2. It may damage the SERVOPACK.

*2. The DC reactor connection terminals are short-circuited when the SERVOPACK is shipped from the factory: ⊖1 and ⊖2.

3.1.2 Using a Standard Power Supply (Single-phase 100 V, Three-phase 200 V, or Three-phase 400 V)

(1) Wire Types

Use the following type of wire for main circuit.

Cable Type		Allowable Conductor Temperature °C
Symbol	Name	
IV	600 V grade polyvinyl chloride insulated wire	60
HIV	600 V grade heat-resistant polyvinyl chloride insulated wire	75

The following table shows the wire sizes and allowable currents for three wires. Use wires with specifications equal to or less than those shown in the table.

- 600 V grade heat-resistant polyvinyl chloride insulated wire (HIV)

AWG Size	Nominal Cross Section Area (mm ²)	Configuration (Number of Wires/mm ²)	Conductive Resistance (Ω/km)	Allowable Current at Surrounding Air Temperature (A)		
				30°C	40°C	50°C
20	0.5	19/0.18	39.5	6.6	5.6	4.5
19	0.75	30/0.18	26.0	8.8	7.0	5.5
18	0.9	37/0.18	24.4	9.0	7.7	6.0
16	1.25	50/0.18	15.6	12.0	11.0	8.5
14	2.0	7/0.6	9.53	23	20	16
12	3.5	7/0.8	5.41	33	29	24
10	5.5	7/1.0	3.47	43	38	31
8	8.0	7/1.2	2.41	55	49	40
6	14.0	7/1.6	1.35	79	70	57
4	22.0	7/2.0	0.85	91	81	66

Note: The values in the table are for reference only.

(2) Main Circuit Wires

This section describes the main circuit wires for SERVOPACKs.

 IMPORTANT	<ul style="list-style-type: none"> • The specified wire sizes are for use when the three lead cables are bundled and when the rated electric current is applied with a surrounding air temperature of 40°C. • Use a wire with a minimum withstand voltage of 600 V for the main circuit. • If cables are bundled in PVC or metal ducts, take into account the reduction of the allowable current. • Use a heat-resistant wire under high surrounding air or panel temperatures, where polyvinyl chloride insulated wires will rapidly deteriorate.
---	--

■ Single-phase, 100 V

Terminal Symbols	Name	SGDV-□□□F			
		R70	R90	2R1	2R8
L1, L2	Main circuit power input terminals	HIV1.25		HIV2.0	
L1C, L2C	Control power input terminals	HIV1.25			
U, V, W	Servomotor connection terminals	HIV1.25			
B1/⊕, B2	External regenerative resistor connection terminals	HIV1.25			
⊕	Ground terminal	HIV2.0 or larger			

■ Three-phase, 200 V

Terminal Symbols	Name	SGDV-□□□A (Unit: mm ²)														
		R70	R90	1R6	2R8	3R8	5R5	7R6	120	180	200	330	470	550	590	780
L1, L2, L3	Main circuit power input terminals	HIV1.25			HIV2.0				HIV3.5		HIV5.5	HIV8.0	HIV14.0	HIV22.0		
L1C, L2C	Control power input terminals	HIV1.25														
U, V, W	Servomotor connection terminals	HIV1.25			HIV2.0				HIV3.5	HIV5.5	HIV8.0	HIV14.0		HIV22.0		
B1/⊕, B2	External regenerative resistor connection terminals	HIV1.25							HIV2.0	HIV3.5	HIV5.5	HIV8.0		HIV22.0		
⊕	Ground terminal	HIV2.0 or larger														

■ Three-phase, 400 V

Terminal Symbols	Name	SGDV-□□□D (Unit: mm ²)									
		1R9	3R5	5R4	8R4	120	170	210	260	280	370
L1, L2, L3	Main circuit power input terminals	HIV1.25			HIV2.0		HIV3.5		HIV5.5	HIV8.0	HIV14.0
24V, 0V	Control power input terminals	HIV1.25									
U, V, W	Servomotor connection terminals	HIV1.25			HIV2.0		HIV3.5	HIV5.5		HIV8.0	HIV14.0
B1/⊕, B2	External regenerative resistor connection terminals	HIV1.25					HIV2.0	HIV3.5		HIV5.5	HIV8.0
⊕	Ground terminal	HIV2.0 or larger									

(3) Typical Main Circuit Wiring Examples

Note the following points when designing the power ON sequence.

- Design the power ON sequence so that main power is turned OFF when a servo alarm signal (ALM) is output.
- The ALM signal is output for a maximum of five seconds when the control power is turned ON. Take this into consideration when designing the power ON sequence. Design the sequence so the ALM signal is activated and the alarm detection relay (1Ry) is turned OFF to stop the main circuit's power supply to the SERVOPACK.

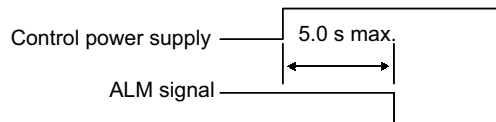

- Select the power supply specifications for the parts in accordance with the input power supply.



IMPORTANT

- When turning ON the control power supply and the main circuit power supply, turn them ON at the same time or turn the main circuit power supply after the control power supply. When turning OFF the power supplies, first turn the power for the main circuit OFF and then turn OFF the control power supply.

The typical main circuit wiring examples are shown below.

 **WARNING**

- Do not touch the power supply terminals after turning OFF the power. High voltage may still remain in the SERVOPACK, resulting in electric shock. When the voltage is discharged, the charge indicator will turn OFF. Make sure the charge indicator is OFF before starting wiring or inspections.

■ Single-phase 100 V, SGD□-□□□F (SGDV-R70F, -R90F, -2R1F, -2R8F)

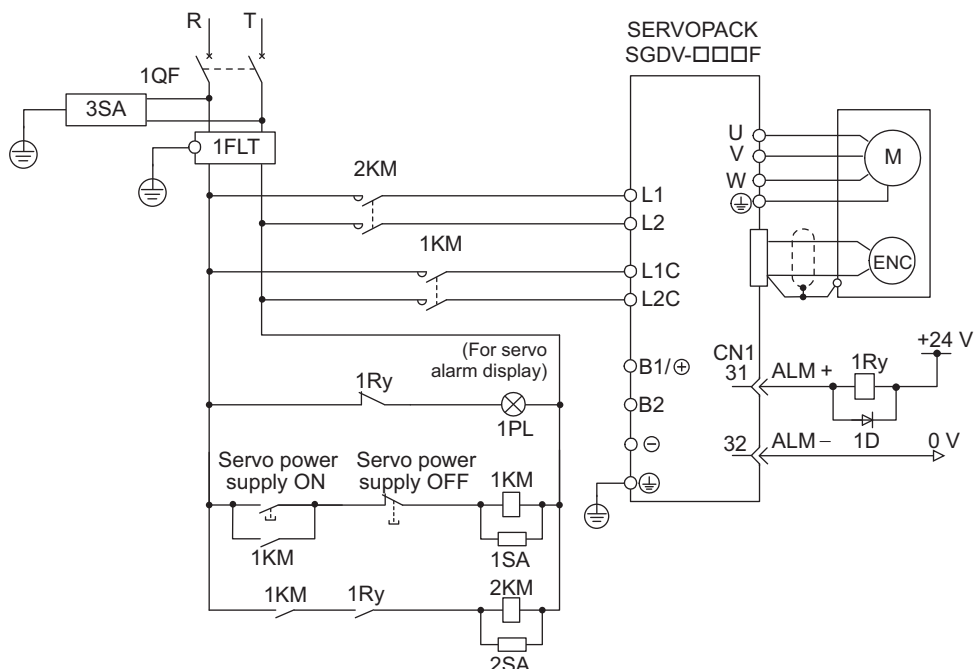

- | | |
|---|---------------------|
| 1QF: Molded-case circuit breaker | 1PL: Indicator lamp |
| 1FLT: Noise filter | 1SA: Surge absorber |
| 1KM: Magnetic contactor (for control power supply) | 2SA: Surge absorber |
| 2KM: Magnetic contactor (for main circuit power supply) | 3SA: Surge absorber |
| 1Ry: Relay | 1D: Flywheel diode |

■ Three-phase 200 V, SGDV-□□□A

- SGDV-R70A, -R90A, -1R6A, -2R8A, -3R8A, -5R5A, -7R6A, -120A, -180A, -200A, -330A

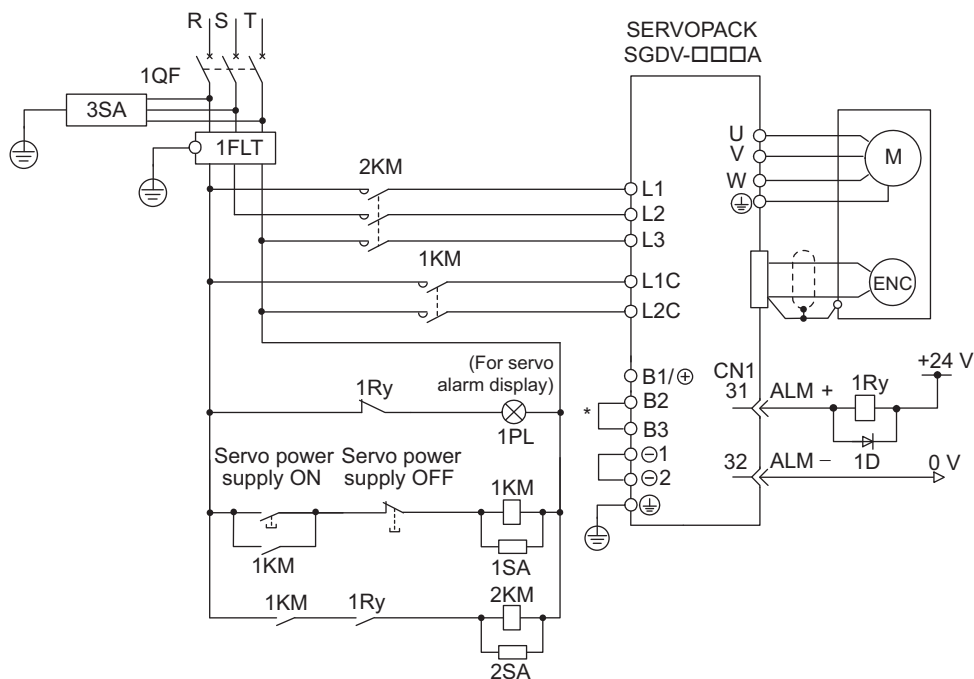

- 1QF: Molded-case circuit breaker
- 1FLT: Noise filter
- 1KM: Magnetic contactor (for control power supply)
- 2KM: Magnetic contactor (for main circuit power supply)
- 1Ry: Relay
- 1PL: Indicator lamp
- 1SA: Surge absorber
- 2SA: Surge absorber
- 3SA: Surge absorber
- 1D: Flywheel diode

* For the SGDV-R70A, -R90A, -1R6A, -2R8A, terminals B2 and B3 are not short-circuited. Do not short-circuit these terminals.

- SGDV-470A, -550A, -590A, -780A

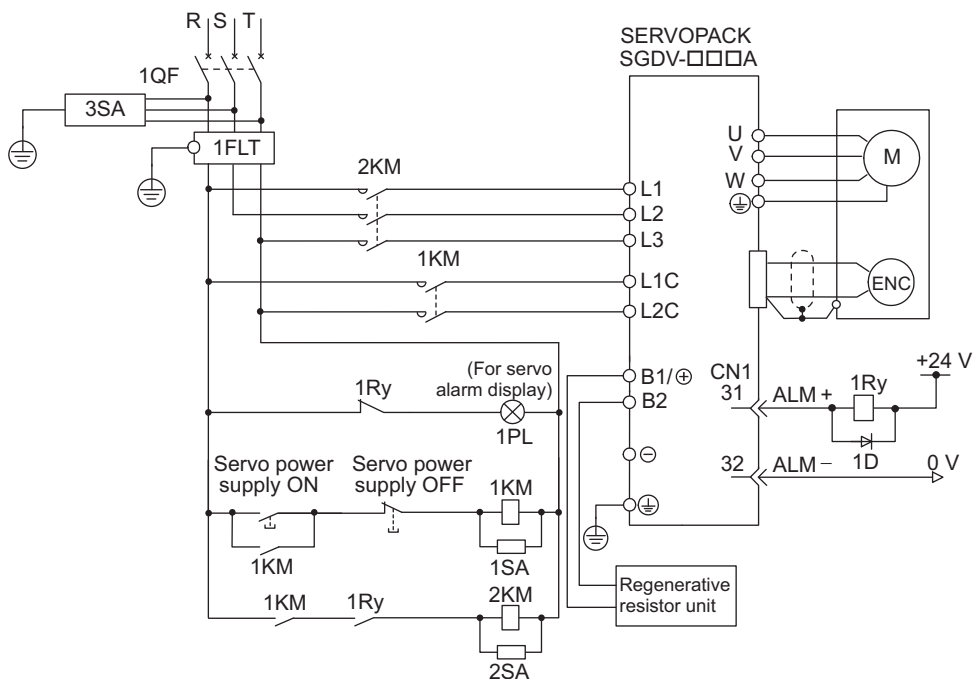

- 1QF: Molded-case circuit breaker
- 1FLT: Noise filter
- 1KM: Magnetic contactor (for control power supply)
- 2KM: Magnetic contactor (for main circuit power supply)
- 1Ry: Relay
- 1PL: Indicator lamp
- 1SA: Surge absorber
- 2SA: Surge absorber
- 3SA: Surge absorber
- 1D: Flywheel diode

■ Three-phase 400 V, SGD□-□□□□D

- SGD□V-1R9D, -3R5D, -5R4D, -8R4D, -120D, -170D

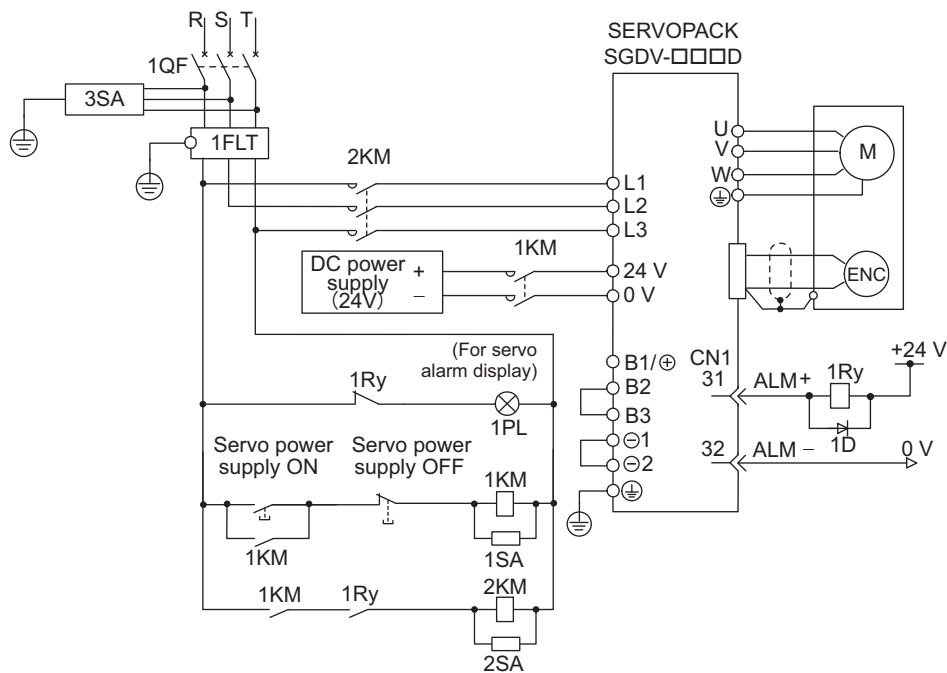

- | | |
|---|---------------------|
| 1QF: Molded-case circuit breaker | 1PL: Indicator lamp |
| 1FLT: Noise filter | 1SA: Surge absorber |
| 1KM: Magnetic contactor (for control power supply) | 2SA: Surge absorber |
| 2KM: Magnetic contactor (for main circuit power supply) | 3SA: Surge absorber |
| 1Ry: Relay | 1D: Flywheel diode |

- SGD□V-210D, -260D, -280D, -370D

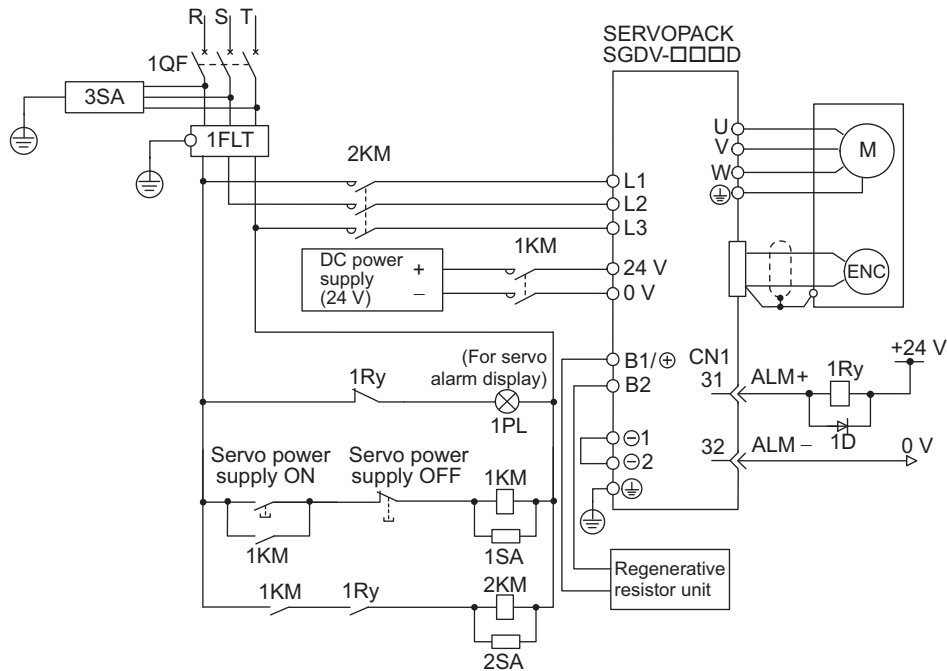

- | | |
|---|---------------------|
| 1QF: Molded-case circuit breaker | 1PL: Indicator lamp |
| 1FLT: Noise filter | 1SA: Surge absorber |
| 1KM: Magnetic contactor (for control power supply) | 2SA: Surge absorber |
| 2KM: Magnetic contactor (for main circuit power supply) | 3SA: Surge absorber |
| 1Ry: Relay | 1D: Flywheel diode |

(4) Power Supply Capacities and Power Losses

The following table shows the SERVOPACK's power supply capacities and power losses.

Main Circuit Power Supply	Maximum Applicable Servomotor Capacity [kW]	SERVOPACK Model SGD V-	Power Supply Capacity per SERVOPACK [kVA]	Output Current [Arms]	Main Circuit Power Loss [W]	Regenerative Resistor Power Loss [W]	Control Circuit Power Loss [W]	Total Power Loss [W]
Single-phase, 100 V	0.05	R70F	0.2	0.66	5.4	-	17	22.4
	0.1	R90F	0.3	0.91	7.8			24.8
	0.2	2R1F	0.7	2.1	14.4			31.4
	0.4	2R8F	1.4	2.8	25.6			42.6
Three-phase, 200 V	0.05	R70A	0.2	0.66	5.1	-	17	22.1
	0.1	R90A	0.3	0.91	7.3			24.3
	0.2	1R6A	0.6	1.6	13.5			30.5
	0.4	2R8A	1	2.8	24.0			41.0
	0.5	3R8A	1.4	3.8	20.1	8	17	45.1
	0.75	5R5A	1.6	5.5	43.8			68.8
	1.0	7R6A	2.3	7.6	53.6	10	22	78.6
	1.5	120A	3.2	11.6	65.8			97.8
	2.0	180A	4	18.5	111.9	16	22	149.9
	3.0	200A	5.9	19.6	113.8			161.4
	5.0	330A	7.5	32.9	263.7	36	27	326.7
	6.0	470A	10.7	46.9	279.4	(180) ^{*1}	33	312.4
	7.5	550A	14.6	54.7	357.8	(350) ^{*2}		390.8
	11	590A	21.7	58.6	431.7		48	479.7
15	780A	29.6	78	599.0	647.0			
Three-phase, 400 V	0.5	1R9D	1.1	1.9	24.6	14	21	59.6
	1.0	3R5D	2.3	3.5	46.1			81.1
	1.5	5R4D	3.5	5.4	71.3			106.3
	2.0	8R4D	4.5	8.4	77.9	28	25	130.9
	3.0	120D	7.1	11.9	108.7			161.7
	5.0	170D	11.7	16.5	161.1	36	24	221.1
	6.0	210D	12.4	20.8	172.7	(180) ^{*3}	27	199.7
	7.5	260D	14.4	25.7	218.6			245.6
	11	280D	21.9	28.1	294.6	(350) ^{*4}	30	324.6
	15	370D	30.6	37.2	403.8			433.8

*1. The value in parentheses is for the JUSP-RA04-E regenerative resistor unit.

*2. The value in parentheses is for the JUSP-RA05-E regenerative resistor unit.

*3. The value in parentheses is for the JUSP-RA18-E regenerative resistor unit.

*4. The value in parentheses is for the JUSP-RA19-E regenerative resistor unit.

Note 1. SGD V-R70F, -R90F, -2R1F, -2R8F, -R70A, -R90A, -1R6A, and -2R8A SERVOPACKs do not have built-in regenerative resistors. Connect an external regenerative resistor if the regenerative energy exceeds the specified value.

2. SGD V-470A, -550A, -590A, -780A, -210D, -260D, -280D, and -370D SERVOPACKs do not have built-in regenerative resistors. Make sure that a regenerative resistor unit or an external regenerative resistor is connected. Refer to 3.6 *Connecting Regenerative Resistors* for details.

3. Regenerative resistor power losses are the allowable losses. Take the following actions if this value is exceeded.

•Remove the lead or shorting bar between terminals B2 and B3 on the SERVOPACK main circuit for SGD V-3R8A, -5R5A, -7R6A, -120A, -180A, -200A, -330A, and 400-V SERVOPACKs.

•Install an external regenerative resistor. Refer to 3.6 *Connecting Regenerative Resistors* for details.

4. Both the regenerative resistor unit and the external regenerative resistor are not included.

(5) How to Select Molded-case Circuit Breaker and Fuse Capacities

The following table shows the SERVOPACK's current capacities and inrush current. Select a molded-case circuit breaker and fuses in accordance with these specifications.

Main Circuit Power Supply	Maximum Applicable Servomotor Capacity [kW]	SERVO- PACK Model SGDV-	Power Supply Capacity per SERVOPACK [kVA]	Current Capacity		Inrush Current	
				Main Circuit [Arms]	Control Circuit [Arms]	Main Circuit [A0-p]	Control Circuit [A0-p]
Single-phase, 100 V	0.05	R70F	0.2	1.5	0.38	16.5	35
	0.1	R90F	0.3	2.5			
	0.2	2R1F	0.7	5			
	0.4	2R8F	1.4	10			
Three-phase, 200 V	0.05	R70A	0.2	1.0	0.2	33	70
	0.1	R90A	0.3	1.0			
	0.2	1R6A	0.6	2.0			
	0.4	2R8A	1	3.0			
	0.5	3R8A	1.4	3.0			
	0.75	5R5A	1.6	6.0			
	1.0	7R6A	2.3	6.0	0.25	33	33
	1.5	120A	3.2	7.3			
	2.0	180A	4	9.7			
	3.0	200A	5.9	15			
	5.0	330A	7.5	25	0.3	65.5	33
	6.0	470A	10.7	29			
	7.5	550A	14.6	37			
	11	590A	21.7	54	0.45	109	48
15	780A	29.6	73				
Three-phase, 400 V	0.5	1R9D	1.1	1.4	1.2	17	-
	1.0	3R5D	2.3	2.9			
	1.5	5R4D	3.5	4.3			
	2.0	8R4D	4.5	5.8	1.4	34	-
	3.0	120D	7.1	8.6			
	5.0	170D	11.7	14.5			
	6.0	210D	12.4	17.4	1.5	34	-
	7.5	260D	14.4	21.7			
	11	280D	21.9	31.8	1.7	68	-
	15	370D	30.6	43.4			

- Note 1. To comply with the EU low voltage directive, connect a fuse to the input side as protection against accidents caused by short-circuits.
 Select fuses or molded-case circuit breakers that are compliant with UL standards.
 The table above also provides the net values of current capacity and inrush current. Select a fuse and a molded-case circuit breaker which meet the breaking characteristics shown below.
- Main circuit, control circuit: No breaking at three times the current values shown in the table for 5 s.
 - Inrush current: No breaking at the current values shown in the table for 20 ms.

3.1.2 Using a Standard Power Supply (Single-phase 100 V, Three-phase 200 V, or Three-phase 400 V)

2. The following restrictions apply to UL standard compliance conditions.

SERVOPACK Model SGD V-	Restrictions
180A, 200A	Available rated current for molded-case circuit breaker: 40 A or less
330A	<ul style="list-style-type: none"> • Available rated current for non-time delay fuse: 70 A or less • Available rated current for time delay fuse: 40 A or less • Do not use single wires.
470A, 550A	<ul style="list-style-type: none"> • Available rated current for molded-case circuit breaker: 60 A or less • Available rated current for non-time delay fuse or time delay fuse: 60 A or less
590A, 780A	<ul style="list-style-type: none"> • Available rated current for molded-case circuit breaker: 100 A or less. • Available rated current for non-time delay fuse or time delay fuse: 100 A or less <p>(Available rated current for a non-time delay, Class J fuse or a faster fuse: 125 A or less)</p>
210D, 260D	<ul style="list-style-type: none"> • Available rated current for molded-case circuit breaker: 60 A or less. • Available rated current for non-time-delay fuse: 60 A or less. • Available rated current for time delay fuse: 35 A or less
280D, 370D	<ul style="list-style-type: none"> • Available rated current for molded-case circuit breaker: 80 A or less • Available rated current for non-time delay fuse: 125 A or less • Available rated current for time delay fuse: 75 A or less

3.1.3 Using the SERVOPACK with Single-phase, 200 V Power Input

Some models of Σ -V series three-phase 200 V power input SERVOPACK can be used also with a single-phase 200 V power supply.

The following models support a single-phase 200-V power input.
SGDV-R70A, -R90A, -1R6A, -2R8A, -5R5A

When using the SERVOPACK with single-phase, 200 V power input, set parameter Pn00B.2 to 1.

There is no need to change the parameter for a SGDV-120A01A008000 SERVOPACK because it uses a single-phase 200 V power supply.

(1) Parameter Setting

■ Single-phase Power Input Selection

Parameter	Meaning	When Enabled	Classification
Pn00B	n.□0□□ [Factory setting]	After restart	Setup
	n.□1□□		

WARNING

- If single-phase 200 V is input to a SERVOPACK with a single-phase power input without changing the setting of Pn00B.2 to 1 (single-phase power input), a main circuit cable open phase alarm (A.F10) will be detected.
- SERVOPACK models other than those for single-phase 200-V power input do not support single-phase power input. If a single-phase 200 V is input to the SERVOPACK that do not support single-phase power input, the main circuit cable open phase alarm (A.F10) will be detected.
- When using a single-phase 200 V power supply, the SGDV-R70A, -R90A, -1R6A, -2R8A, or -5R5A SERVOPACK may not be able to produce the same servomotor torque-speed characteristics as using a three-phase 200 V power input. Refer to the diagram of each servomotor torque-speed characteristics in *Σ -V Series Product Catalog* (No.: KAEP S800000 42).

(2) Main Circuit Power Input Terminals

Connect a single-phase 200 V power supply of the following specifications to L1 and L2 terminals.

The specifications of the power supplies other than the main circuit power supply are the same as for three-phase power supply input.

Terminal Symbols	Name	Model SGDV-□□□A	Specifications
L1, L2	Main circuit power input terminals	R70, R90, 1R6, 2R8, 5R5	Single-phase 200 V to 230 V, +10% to -15% (50/60 Hz)
		120*2	Single-phase 220 V to 230 V, +10% to -15% (50/60 Hz)
L3*1	—	R70, R90, 1R6, 2R8, 5R5	None

*1. Do not use L3 terminal.

*2. The official model number is SGDV-120A01A008000.

(3) Main Circuit Wire for SERVOPACKs

Terminal Symbols	Name	Model SGD□-□□□A (Unit: mm ²)					
		R70	R90	1R6	2R8	5R5	120*
L1, L2	Main circuit power input terminals	HIV1.25			HIV2.0		HIV3.5
L1C, L2C	Control power input terminals	HIV1.25					
U, V, W	Servomotor connection terminals	HIV1.25			HIV2.0		
B1/⊕, B2	External regenerative resistor connection terminals	HIV1.25					
⊕	Ground terminal	HIV2.0 or larger					

* The official model number is SGD□-120A01A008000.

(4) Wiring Example with Single-phase 200-V Power Supply Input

■ SERVOPACK with Single-phase, 200-V Power Supply

Applicable SERVOPACK Model: SGDV-R70A, -R90A, -1R6A, -2R8A, -5R5A, and -120A01A008000.

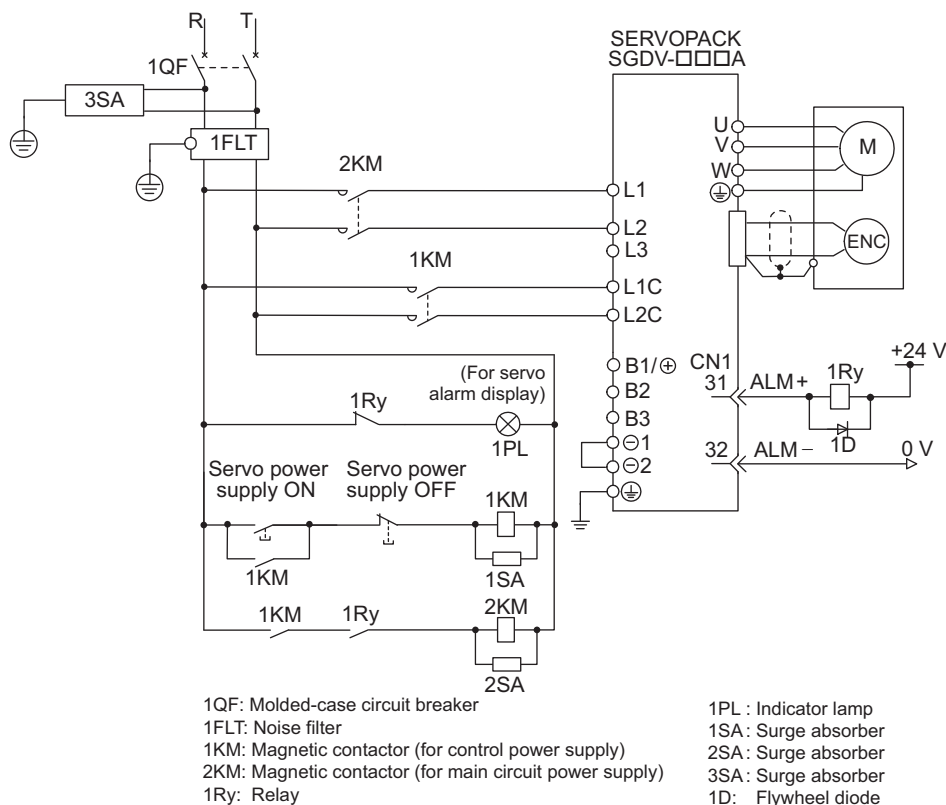

(5) Power Supply Capacities and Power Losses

The following table shows SERVOPACK's power supply capacities and power losses when using single-phase 200 V power supply.

Main Circuit Power Supply	Maximum Applicable Servomotor Capacity [kW]	SERVOPACK Model SGDV-	Power Supply Capacity per SERVOPACK [kVA]	Output Current [Arms]	Main Circuit Power Loss [W]	Regenerative Resistor Power Loss [W]	Control Circuit Power Loss [W]	Total Power Loss [W]
Single-phase, 200 V	0.05	R70A	0.2	0.66	5.2	-	17	22.2
	0.1	R90A	0.3	0.91	7.4			24.4
	0.2	1R6A	0.7	1.6	13.7			30.7
	0.4	2R8A	1.2	2.8	24.9			41.9
	0.75	5R5A	1.9	5.5	52.7	8	77.7	
	1.5	120A*	4	11.6	68.2	10	22	100.2

* The official model number is SGDV-120A01A008000.

Note 1. SGDV-R70A, -R90A, -1R6A, and -2R8A SERVOPACKs do not have built-in regenerative resistors. If the regenerative energy exceeds the specified value, connect an external regenerative resistor between B1/⊕ and B2.

2. Regenerative resistor power losses are allowable losses. Take the following action if this value is exceeded.

- Remove the lead or shorting bar between terminals B2 and B3 on the SERVOPACK main circuit of SGDV-5R5A, -120A SERVOPACKs.

- Install an external regenerative resistor between external regenerative resistor connection terminals B1/⊕ and B2.

3. External regenerative resistors are not included.

(6) How to Select Molded-case Circuit Breaker and Fuse Capacities

The following table shows the SERVOPACK's current capacities and inrush current when using single-phase 200 V power supply. Select a molded-case circuit breaker and fuses in accordance with these specifications.

Main Circuit Power Supply	Maximum Applicable Servomotor Capacity [kW]	SERVO-PACK Model SGD V-	Power Supply Capacity per SERVOPACK [kVA]	Current Capacity		Inrush Current	
				Main Circuit [Arms]	Control Circuit [Arms]	Main Circuit [A0-p]	Control Circuit [A0-p]
Single-phase, 200 V	0.05	R70A	0.2	2	0.2	33	70
	0.1	R90A	0.3	2			
	0.2	1R6A	0.7	3			
	0.4	2R8A	1.2	5			
	0.75	5R5A	1.9	9			
	1.5	120A*	4	16	0.25	33	

* The official model number is SGD V-120A01A008000.

- Note 1. To comply with the EU low voltage directive, connect a fuse to the input side as protection against accidents caused by short-circuits. Select the fuse for the input side that are compliant with UL standards. The table above also provides the net values of current capacity and inrush current. Select a fuse and a molded-case circuit breaker which meet the breaking characteristics shown below.
- Main circuit, control circuit: No breaking at three times the current values shown in the table for 5 s.
 - Inrush current: No breaking at the current values shown in the table for 20 ms.
2. The following restrictions apply to UL standard compliance conditions for SGD V-120A01A008000 SERVOPACKs.
- Current rating when using molded-case circuit breaker: 40 A max.

3.1.4 Using the SERVOPACK with a DC Power Input

(1) Parameter Setting

When using a DC power supply, make sure to set the parameter Pn001.2 to 1 (DC power input supported) before inputting DC power.

Parameter	Meaning	When Enabled	Classification
Pn001	n.□0□□	Enables use of AC power input.	After restart
	n.□1□□	Enables use of DC power input.	

Observe the following precautions.

 WARNING
<ul style="list-style-type: none"> • Either AC or DC power can be input to the 200-V, 400-V SERVOPACKs. Always set Pn001.2 to 1 to specify a DC power input before inputting DC power. Only AC power can be input to the 100-V SERVOPACKs. If DC power is input without changing the parameter setting, the SERVOPACK's internal elements will burn and may cause fire or damage to the equipment. • With a DC power input, time is required to discharge electricity after the main power supply is turned OFF. A high residual voltage may remain in the SERVOPACK after the power supply is turned OFF. Be careful not to get an electric shock. • Install fuses on the wires if DC power is used. • Servomotor returns a regenerated energy to the power supply. The SERVOPACK that can use a DC power supply is not capable of processing the regenerated energy. Provide measures to process the regenerated energy on the power supply. • With a DC power input, connect an external inrush current limit circuit. Failure to observe this caution may result in damage to the equipment.

(2) DC Power Supply Input Terminals for the Main and Control Circuits

- Three-phase, 200 V for SGD□-□□□A
(□□□ = R70, R90, 1R6, 2R8, 3R8, 5R5, 7R6, 120, 180, 200, 330)

Terminal Symbols	Name	Specifications
B1/ ⊕	Main circuit positive terminal	270 to 320 VDC
⊖ 2	Main circuit negative terminal	0 VDC
L1C, L2C	Control power input terminal	200 to 230 VAC

- Three-phase 200-V SGD□-□□□A
(□□□ = 470, 550, 590, 780)

Terminal Symbols	Name	Specifications
B1/ ⊕	Main circuit positive terminal	270 to 320 VDC
⊖	Main circuit negative terminal	0 VDC
L1C, L2C	Control power input terminal	200 to 230 VAC

- Three-phase, 400 V for SGD□-□□□D
(□□□ = 1R9, 3R5, 5R4, 8R4, 120, 170, 210, 260, 280, 370)

Terminal Symbols	Name	Specifications
B1/ ⊕	Main circuit positive terminal	513 to 648 VDC
⊖ 2	Main circuit negative terminal	0 VDC
24 V, 0 V	Control power input terminal	24 VDC±15%

(3) Wiring Example with DC Power Supply Input

■ 200-V SERVOPACK SGDV-□□□A

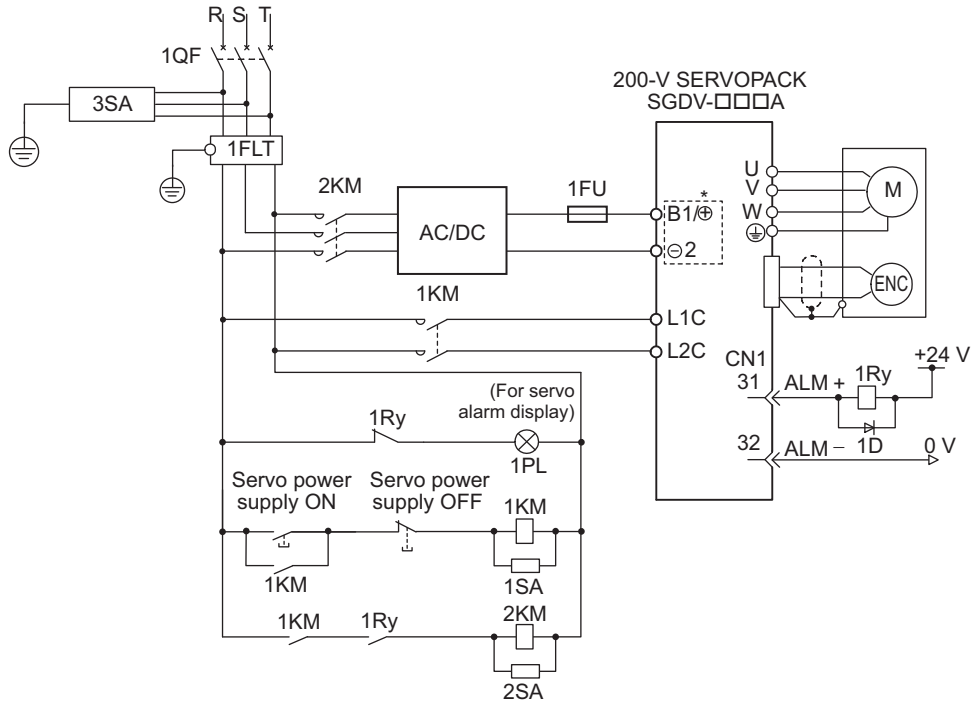

- 1QF: Molded-case circuit breaker
- 1FLT: Noise filter
- 1KM: Magnetic contactor (for control power supply)
- 2KM: Magnetic contactor (for main circuit power supply)
- 1Ry: Relay
- 1PL: Indicator lamp
- 1SA: Surge absorber
- 2SA: Surge absorber
- 3SA: Surge absorber
- 1D: Flywheel diode

* Terminal names differ depending on model of SERVOPACK. Refer to (2) DC Power Supply Input Terminals for the Main and Control Circuits.

■ 400-V SERVOPACK SGDV-□□□D

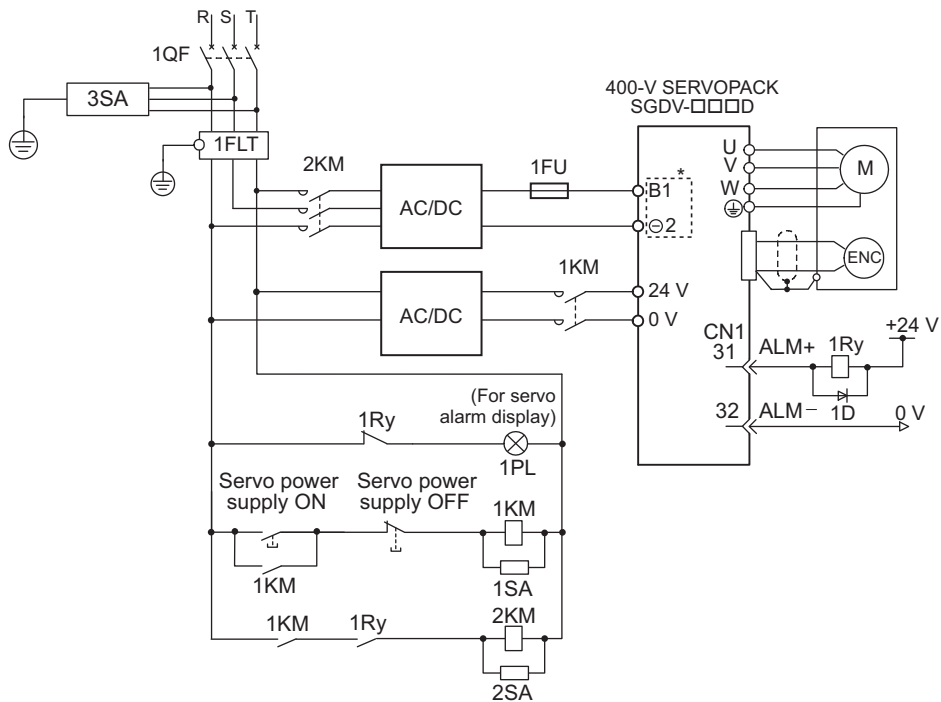

- 1QF: Molded-case circuit breaker
- 1FLT: Noise filter
- 1KM: Magnetic contactor (for control power supply)
- 2KM: Magnetic contactor (for main circuit power supply)
- 1Ry: Relay
- 1PL: Indicator lamp
- 1SA: Surge absorber
- 2SA: Surge absorber
- 3SA: Surge absorber
- 1D: Flywheel diode

* Terminal names differ depending on model of SERVOPACK. Refer to (2) DC Power Supply Input Terminals for the Main and Control Circuits.

3.1.5 Using More Than One SERVOPACK

This section shows an example of the wiring and the precautions when more than one SERVOPACK is used.

(1) Wiring Example

Connect the alarm output (ALM) terminals for three SERVOPACKs in series to enable alarm detection relay 1Ry to operate. When the alarm occurs, the ALM output signal transistor is turned OFF.

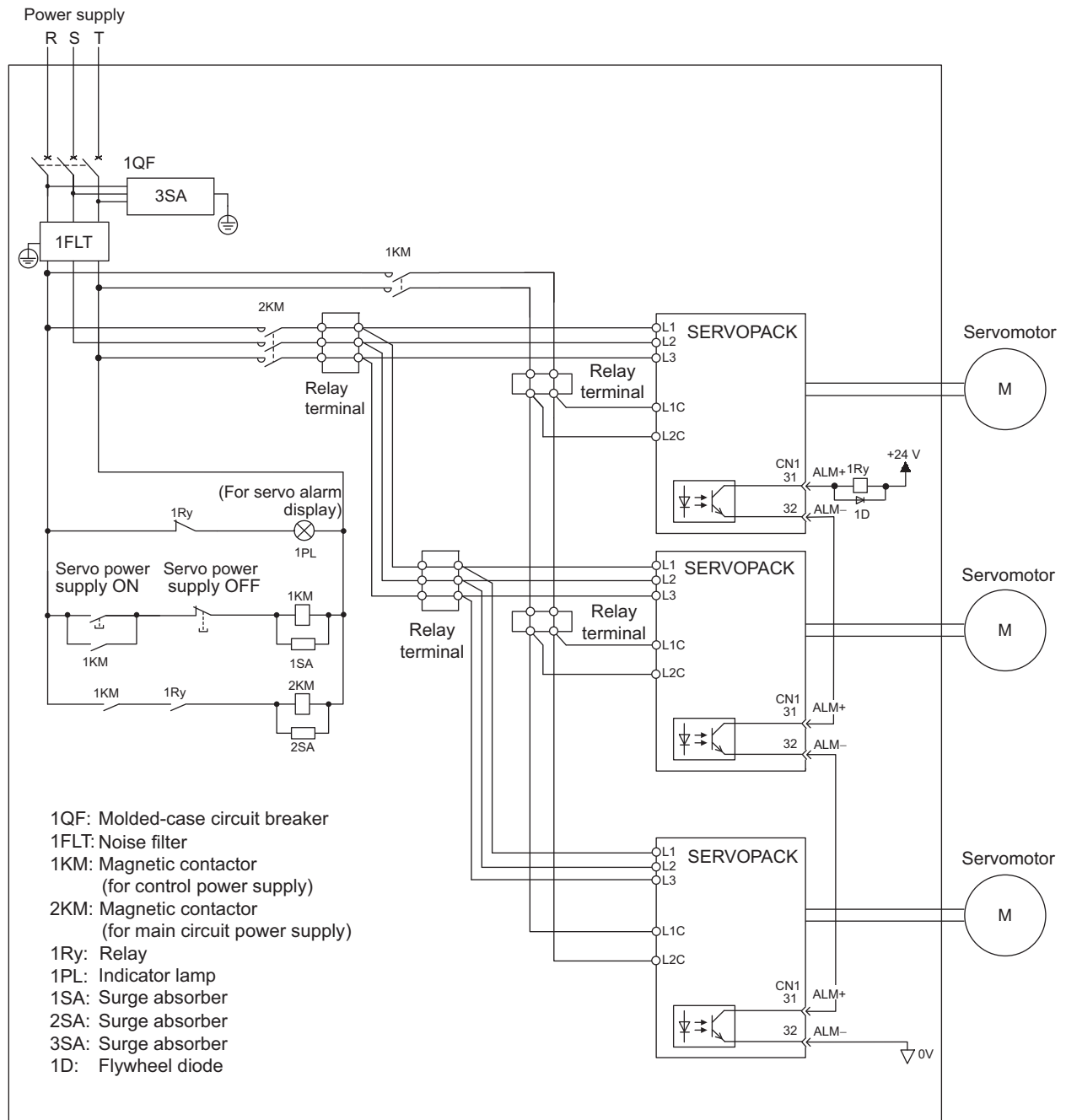

(2) Precautions

Multiple SERVOPACKs can share a single molded-case circuit breaker (1QF) or noise filter. Always select a molded-case circuit breaker or noise filter that has enough capacity for the total power supply capacity (load conditions) of the SERVOPACKs.

3.1.6 General Precautions for Wiring



IMPORTANT

- Use a molded-case circuit breaker (1QF) or fuse to protect the main circuit.
The SERVOPACK connects directly to a commercial power supply; it is not isolated through a transformer or other device.
Always use a molded-case circuit breaker (1QF) or fuse to protect the servo system from accidents involving different power system voltages or other accidents.
- Install a ground fault detector.
The SERVOPACK does not have a built-in protective circuit for grounding.
To configure a safer system, install a ground fault detector against overloads and short-circuiting, or install a ground fault detector combined with a molded-case circuit breaker.
- Do not turn the power ON and OFF more than necessary.
 - Do not use the SERVOPACK for applications that require the power to turn ON and OFF frequently. Such applications will cause elements in the SERVOPACK to deteriorate.
 - As a guideline, at least one hour should be allowed between the power being turned ON and OFF once actual operation has been started.

To ensure safe, stable application of the servo system, observe the following precautions when wiring.

- Use the connection cables specified in the *Σ-V Series Product Catalog* (No.: KAEP S800000 42). Design and arrange the system so that each cable will be as short as possible.
- Use shielded twisted-pair cables or screened unshielded twisted-pair cables for I/O signal cables and encoder cables.
- The maximum wiring length is 3 m for I/O signal cables, 50 m for encoder cables or servomotor main circuit cables, and 10 m for control power supply cables for the SERVOPACK with a 400-V power supply (+24 V, 0 V).
- Observe the following precautions when wiring the ground.
 - Use a cable as thick as possible (at least 2.0 mm²).
 - Grounding to a resistance of 100 Ω or less for 100-V, 200-V SERVOPACKs, 10 Ω or less for 400-V SERVOPACKs is recommended.
 - Be sure to ground at only one point.
 - Ground the servomotor directly if the servomotor is insulated from the machine.
- The signal cable conductors are as thin as 0.2 mm² or 0.3 mm². Do not impose excessive bending force or tension.

3.2 I/O Signal Connections

This section describes the names and functions of I/O signals (CN1). Also connection examples by control method are shown.

3.2.1 I/O Signal (CN1) Names and Functions

The following table shows the names and functions of I/O signals (CN1).

(1) Input Signals

Control Method	Signal Name	Pin No.	Function		Reference Section	
Common	/S-ON	40	Servo ON/OFF: Turns ON/OFF the servomotor.		5.2.1	
	/P-CON	41	Proportional control reference	Switches the speed control loop from PI (proportional/integral) to P (proportional) control when ON.	6.9.4	
			Rotation Direction reference	With internal set speed control selected: Switches the servomotor rotation direction.	5.6.1	
			Control switching	Position ↔ speed Position ↔ torque Torque ↔ speed	} Enables control switching.	5.7.2
			Zero-clamp reference	With speed control with zero-clamp function selected: Reference speed is zero when ON.		
			Reference pulse block	With position control with reference pulse stop selected: Stops reference pulse input when ON.	5.4.8	
	P-OT N-OT	42 43	Forward run prohibited, Reverse run prohibited	With overtravel prevention: Stops servomotor when movable part travels beyond the allowable range of motion.	5.2.3	
	/P-CL /N-CL	45 46	Forward external torque limit, Reverse external torque limit	Activates/deactivates external torque limit function.	5.8.2 5.8.4	
			Internal set speed switching	With internal set speed control selected: Switches the internal set speed settings.	5.6.1	
	/ALM-RST	44	Alarm reset: Releases the servo alarm state.		—	
	+24VIN	47	Control power supply input for sequence signals. Allowable voltage range: 11 to 25 V Note: The 24 VDC power supply is not included.		3.4.2	
	SEN	4 (2)	Initial data request signal when using an absolute encoder.		5.9.2	
	BAT (+)	21	Connecting pin for the absolute encoder backup battery.		3.5.2	
	BAT (-)	22	Do not connect when the encoder cable with the battery case is used.		5.9.1	
	/SPD-D /SPD-A /SPD-B /C-SEL /ZCLAMP /INHIBIT /G-SEL /PSEL	Signals that can be allocated	The following input signals can be changed to allocate functions: /S-ON, /P-CON, P-OT, N-OT, /P-CL, /N-CL, and /ALM-RST.		3.3.1	
5.3.5						
5.4.3						
5.4.8						
5.6.1						
5.7.1						
6.8.1						
Speed	V-REF	5 (6)	Inputs speed reference. Input voltage range: ± 12 V max.		5.3.1 5.5.4	

(cont'd)

Control Method	Signal Name	Pin No.	Function	Reference Section
Position	PULS /PULS SIGN /SIGN	7 8 11 12	Input pulse modes: Select one of them. <ul style="list-style-type: none"> • Sign + pulse train • CW + CCW pulse train • Two-phase pulse train with 90° phase differential 	5.4.1
	CLR /CLR	15 14	Clears position error during position control.	5.4.2
Torque	T-REF	9 (10)	Inputs torque reference. Input voltage range: ± 12 V max.	5.5.1 5.8.3 5.8.5

Note: Pin numbers in parentheses () indicate signal grounds.

(2) Output Signals

Control Method	Signal Name	Pin No.	Function	Reference Section	
Common	ALM+ ALM-	31 32	Servo alarm: Turns OFF when an error is detected.	5.10.1	
	/TGON+ /TGON-	27 28	Detection during servomotor rotation: Turns ON when the servomotor is rotating at a speed higher than the motor speed setting.	5.10.3	
	/S-RDY+ /S-RDY-	29 30	Servo ready: Turns ON when the SERVOPACK is ready to accept the servo ON (/S-ON) signal.	5.10.4	
	PAO /PAO	33 34	Phase-A signal	Encoder output pulse signals for two-phase pulse train with 90° phase differential	5.3.6 5.9.5
	PBO /PBO	35 36	Phase-B signal		
	PCO /PCO	19 20	Phase-C signal	Origin pulse output signal	
	ALO1 ALO2 ALO3	37 (1) 38 (1) 39 (1)	Alarm code output: Outputs 3-bit alarm codes.	5.10.1	
	FG	Shell	Connected to frame ground if the shielded wire of the I/O signal cable is connected to the connector shell.	–	
	/CLT /VLT /BK /WARN /NEAR /PSELA	Signals that can be allocated	The following output signals can be changed to allocate functions: /TGON, /S-RDY, and /V-CMP (/COIN).	5.4.3 5.4.7 5.5.4 5.8.5 5.10.2	
Speed	/V-CMP+ /V-CMP-	25 26	If speed control is selected, the signal turns ON when the motor speed is within the setting range and it matches the reference speed value.	5.3.8	
Position	/COIN+ /COIN-	25 26	If position control is selected, the signal turns ON when the number of position error reaches the value set.	5.4.6	
	PL1 PL2 PL3	3 13 18	Output signals of power supply for open-collector reference	3.4.1	
Reserved	–	16 17 23 24 48 49 50	Do not use these pins.	–	

Note 1. Pin numbers in parentheses () indicate signal grounds.

2. The functions allocated to /TGON, /S-RDY, and /V-CMP (/COIN) output signals can be changed by using the parameters. Refer to 3.3.2 *Output Signal Allocations* for details.

3.2.2 Safety Function Signal (CN8) Names and Functions

The following table shows the terminal layout of safety function signals (CN8).

Signal Name	Pin No.	Function	
/HWBB1+	4	Hard wire baseblock input 1	For hard wire baseblock input. Baseblock (motor current off) when OFF.
/HWBB1-	3		
/HWBB2+	6	Hard wire baseblock input 2	
/HWBB2-	5		
EDM1+	8	Monitored circuit status output 1	ON when the /HWBB1 and the /HWBB2 signals are input and the SERVOPACK enters a baseblock state.
EDM1-	7		
-	1*	-	
-	2*	-	

* Do not use pins 1 and 2 because they are connected to the internal circuits.

3.2.3 Example of I/O Signal Connections in Speed Control

Connection example in speed control is as shown below.

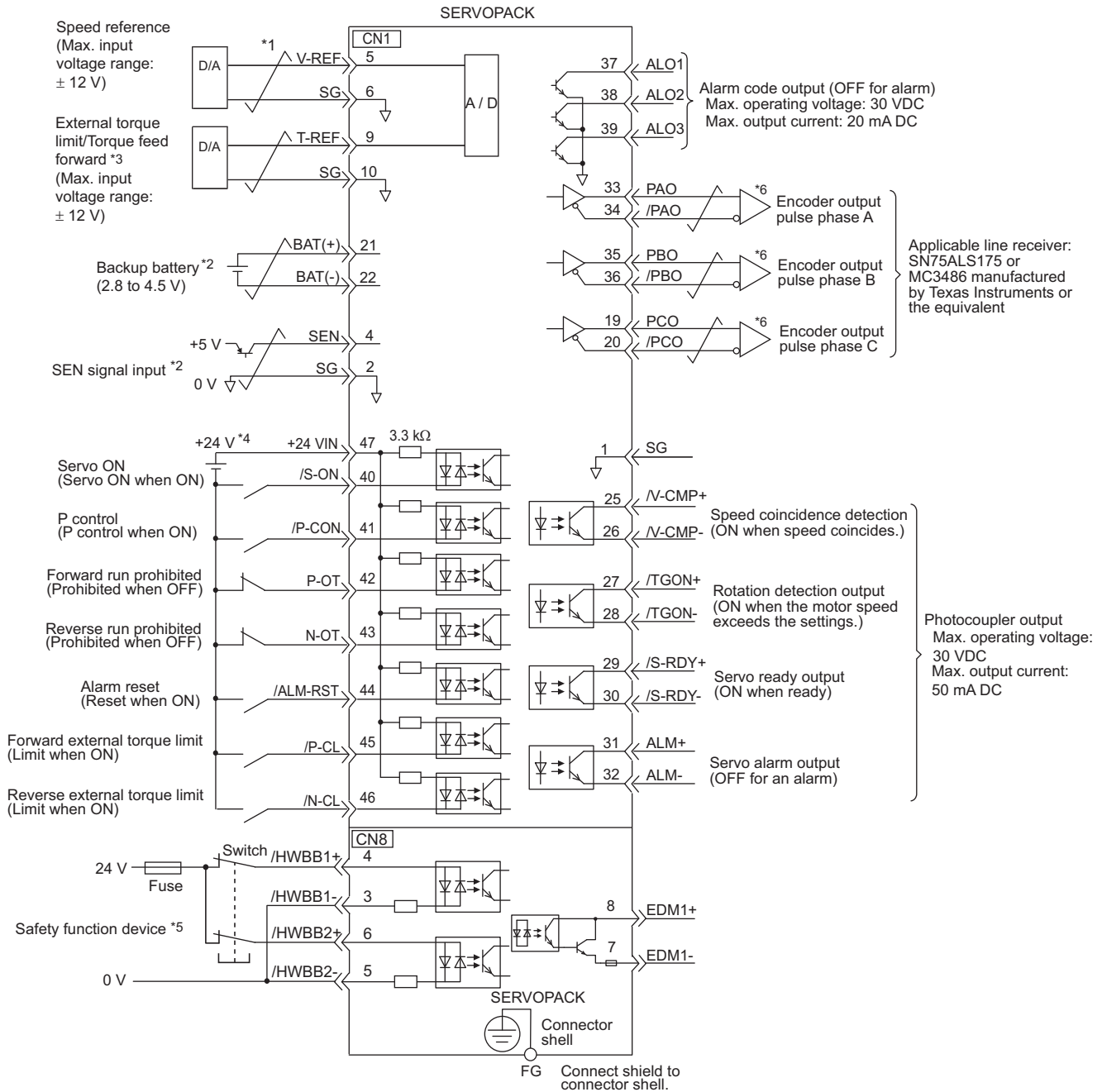

- *1.  represents twisted-pair wires.
- *2. Connect when using an absolute encoder. When the encoder cable with the battery case is connected, do not connect a backup battery.
- *3. Enabled by the parameter setting.
- *4. The 24-VDC power supply is not included. Use a 24-VDC power supply with double insulation or reinforced insulation.
- *5. When using the safety function, a safety function device must be connected and the wiring that is necessary to activate the safety function must be done to turn ON the servomotor power. When not using the safety function, use the SERVOPACK with the JZSP-CVH05-E Plug (provided as an accessory) inserted into the CN8.
- *6. Always use line receivers to receive the output signals.

3.2.4 Example of I/O Signal Connections in Position Control

Connection example in position control is as shown below.

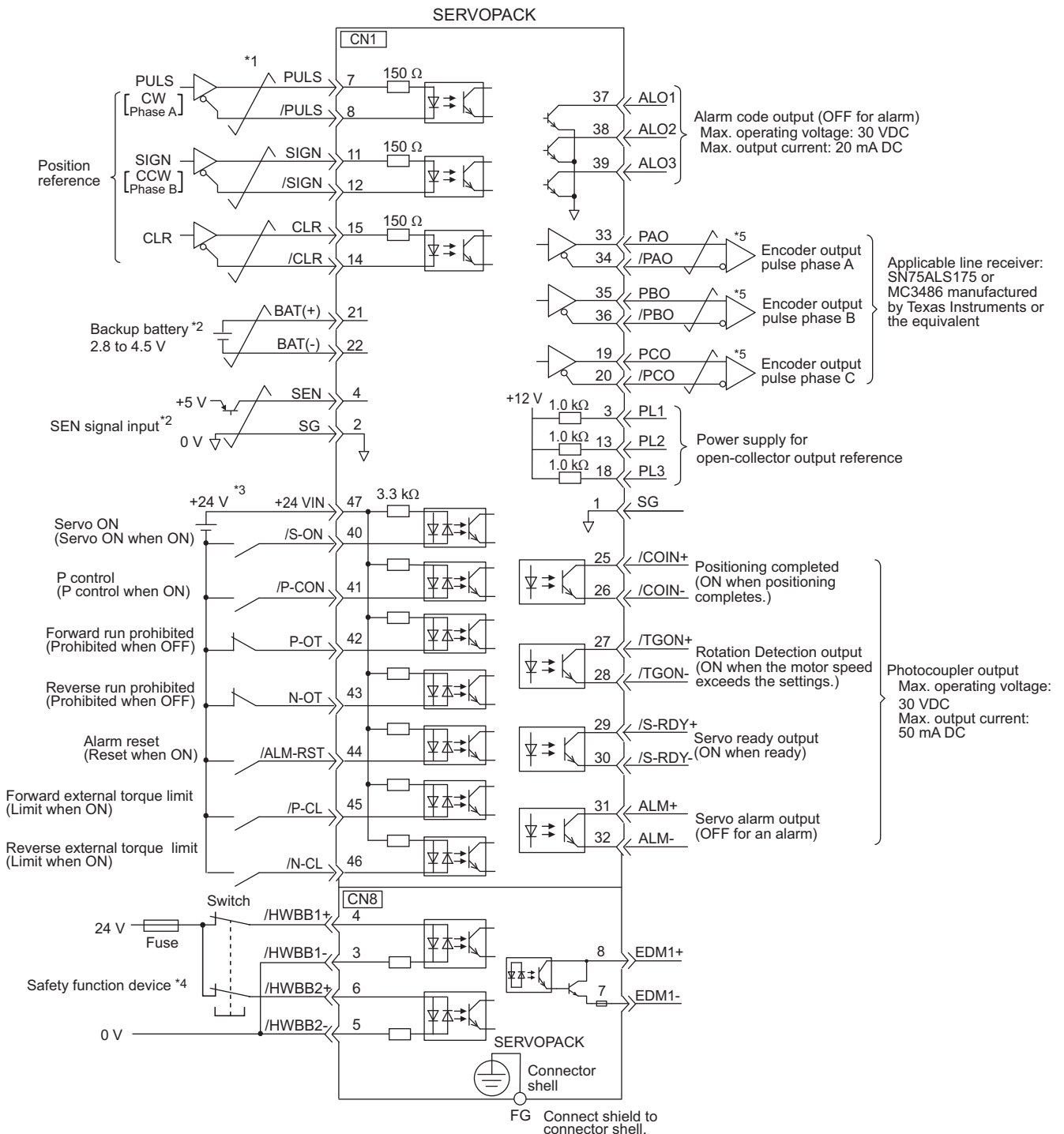

- *1. represents twisted-pair wires.
- *2. Connect when using an absolute encoder. When the encoder cable with the battery case is connected, do not connect a backup battery.
- *3. The 24-VDC power supply is not included. Use a 24-VDC power supply with double insulation or reinforced insulation.
- *4. When using the safety function, a safety function device must be connected and the wiring that is necessary to activate the safety function must be done to turn ON the servomotor power. When not using the safety function, use the SERVOPACK with the JZSP-CVH05-E Plug (provided as an accessory) inserted into the CN8.
- *5. Always use line receivers to receive the output signals.

3.2.5 Example of I/O Signal Connections in Torque Control

Connection example in torque control is as shown below.

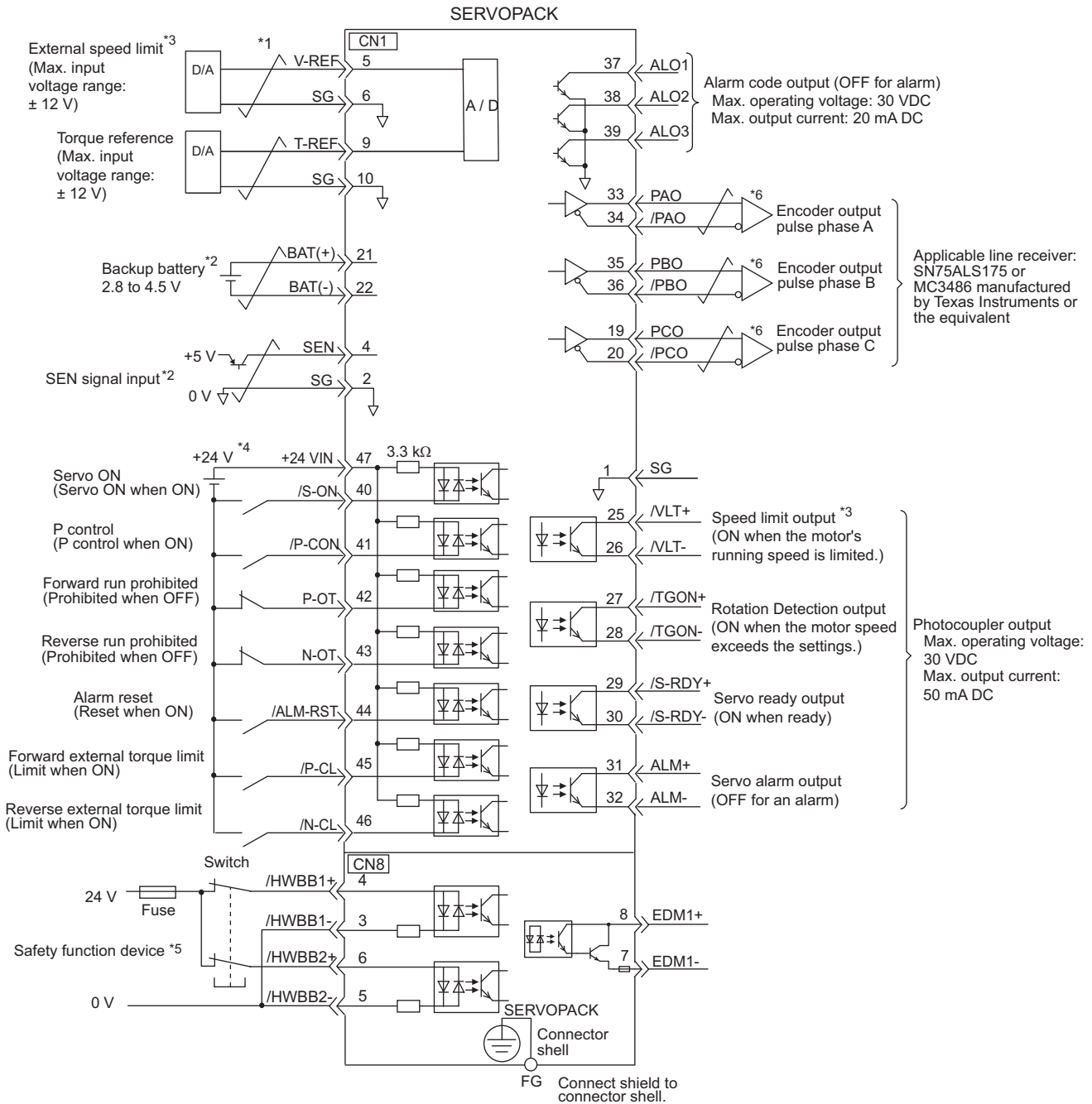

- *1. represents twisted-pair wires.
- *2. Connect when using an absolute encoder. When the encoder cable with the battery case is connected, do not connect a backup battery.
- *3. Enabled by the parameter setting.
- *4. The 24-VDC power supply is not included. Use a 24-VDC power supply with double insulation or reinforced insulation.
- *5. When using the safety function, a safety function device must be connected and the wiring that is necessary to activate the safety function must be done to turn ON the servomotor power. When not using the safety function, use the SERVOPACK with the JZSP-CVH05-E Plug (provided as an accessory) inserted into the CN8.
- *6. Always use line receivers to receive the output signals.

3.3 I/O Signal Allocations

This section describes the I/O signal allocations.

3.3.1 Input Signal Allocations

In most cases, input signals can be used at the factory settings. Input signals can also be allocated as required.

(1) Using Factory Settings

Items in cells with bold lines in the following table are the factory-set signal allocations.

If the control method is changed in Pn000.1, the signals will function as required for the control method. The factory-set signal allocations will remain unchanged.

<Example>

When the control method is set to internal set speed control with a contact reference, i.e., when Pn000.1 is set to 3, signal /P-CON (CN1-41) will function as /SPD-D, signal /P-CL (CN1-45) as /SPD-A, and signal /N-CL (CN1-46) as /SPD-B.

Pn000.1 Setting	Control Method Selection	CN1 Pin No.									
		40	41	42	43	44	45	46			
0	Speed control	/S-ON	Uses as /P-CON	P-OT	N-OT	/ALM-RST	/P-CL	/N-CL			
1	Position control								Uses as /SPD-D	Uses as /SPD-A	Uses as /SPD-B
2	Torque control										
3	Internal set speed control										
4	Internal set speed control ⇔ Speed control										
5	Internal set speed control ⇔ Position control										
6	Internal set speed control ⇔ Torque control										
7	Position control ⇔ Speed control		Uses as /C-SEL				Uses as /P-CL	Uses as /N-CL			
8	Position control ⇔ Torque control										
9	Torque control ⇔ Speed control										
A	Speed control ⇔ Speed control with zero clamp function	Uses as /ZCLAMP	Uses as /INHIBIT								
B	Position control ⇔ Position control with reference pulse inhibit function										

Input signal allocation at factory setting can be checked using the parameters Pn50A and Pn50B.

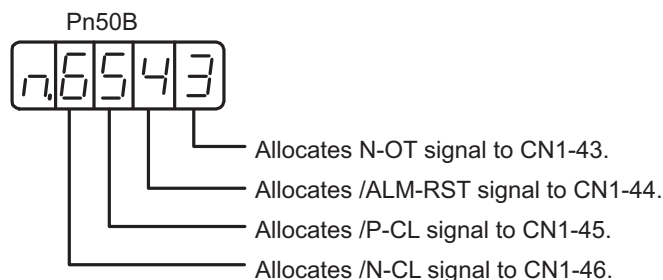
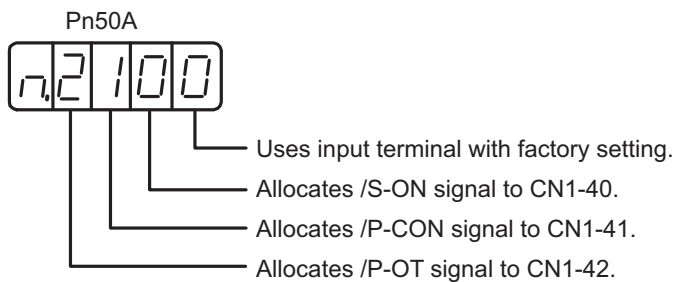

(2) Changing Input Signal Allocations



IMPORTANT

- Inverting the polarity of the Servo ON, forward run prohibited, and reverse run prohibited signals from the factory setting will prevent the main circuit's power supply from being turned OFF or the overtravel function from working in case of signal line disconnections or other failures. If this setting is absolutely necessary, check the operation and confirm that there are no safety problems.
- When two or more signals are allocated to the same input circuit, input signal level is valid for all allocated signals, resulting in an unexpected machine operation.

When changing input signal allocations, set Pn50A.0 to 1 to enable making the changes. Input signals are allocated as shown in the following table.

Refer to the *Interpreting the Input Signal Allocation Tables* and change the allocations accordingly.

<Interpreting the Input Signal Allocation Tables>

Level at which input signal allocations are valid.

The parameter set values to be used are shown. Signals are allocated to CN1 pins according to the selected set values. Values in cells in bold lines are the factory settings.

Input Signal Names and Parameters	Validity Level	Input Signal	CN1 Pin Numbers								Connection Not Required (SERVOPACK judges the connection)	
			40	41	42	43	44	45	46	Always ON	Always OFF	
Servo ON Pn50A.1	L	/S-ON	0	1	2	3	4	5	6	7	8	
	H	S-ON	9	A	B	C	D	E	F			









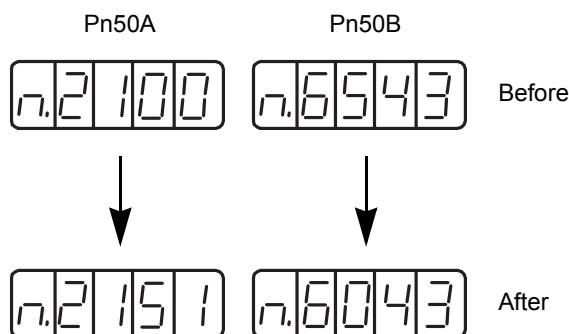





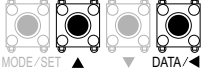
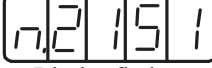

If always ON (7) or always OFF (8) is set, signals will be processed in the SERVOPACK, which will eliminate the need for wiring changes.

Input Signal Names and Parameters	Validity Level	Input Signal	CN1 Pin Numbers						Connection Not Required (SERVOPACK judges the connection)		
			40	41	42	43	44	45	46	Always ON	Always OFF
Servo ON Pn50A.1	L	/S-ON	0	1	2	3	4	5	6	7	8
	H	S-ON	9	A	B	C	D	E	F		
Proportional Operation Reference Pn50A.2	L	/P-CON	0	1	2	3	4	5	6	7	8
	H	P-CON	9	A	B	C	D	E	F		
Forward Run Prohibited Pn50A.3	H	P-OT	0	1	2	3	4	5	6	7	8
	L	/P-OT	9	A	B	C	D	E	F		
Reverse Run Prohibited Pn50B.0	H	N-OT	0	1	2	3	4	5	6	7	8
	L	/N-OT	9	A	B	C	D	E	F		
Alarm Reset Pn50B.1	L	/ARM-RST	0	1	2	3	4	5	6	-	8
	H	ARM-RST	9	A	B	C	D	E	F		
Forward External Torque Limit Pn50B.2	L	/P-CL	0	1	2	3	4	5	6	7	8
	H	P-CL	9	A	B	C	D	E	F		
Reverse External Torque Limit Pn50B.3	L	/N-CL	0	1	2	3	4	5	6	7	8
	H	N-CL	9	A	B	C	D	E	F		
Switching Servomotor Rotation Direction Pn50C.0	L	/SPD-D	0	1	2	3	4	5	6	7	8
	H	SPD-D	9	A	B	C	D	E	F		
Internal Set Speed Control Pn50C.1	L	/SPD-A	0	1	2	3	4	5	6	7	8
	H	SPD-A	9	A	B	C	D	E	F		
Internal Set Speed Control Pn50C.2	L	/SPD-B	0	1	2	3	4	5	6	7	8
	H	SPD-B	9	A	B	C	D	E	F		
Control Method Selection Pn50C.3	L	/C-SEL	0	1	2	3	4	5	6	7	8
	H	C-SEL	9	A	B	C	D	E	F		
Zero Clamp Pn50D.0	L	/ZCLAMP	0	1	2	3	4	5	6	7	8
	H	ZCLAMP	9	A	B	C	D	E	F		
Reference Pulse Inhibit Pn50D.1	L	/INHIBIT	0	1	2	3	4	5	6	7	8
	H	INHIBIT	9	A	B	C	D	E	F		
Gain Changeover Pn50D.2	L	/G-SEL	0	1	2	3	4	5	6	7	8
	H	G-SEL	9	A	B	C	D	E	F		
Reference Pulse Input Multiplication Switching Pn515.1	L	/PSEL	0	1	2	3	4	5	6	7	8
	H	PSEL	9	A	B	C	D	E	F		

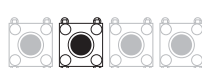
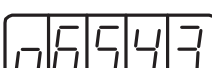
(3) Example of Input Signal Allocation

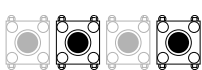
The procedure to replace Servo ON (/S-ON) signal allocated on CN1-40 and Forward External Torque Limit (/P-CL) allocated on CN1-45 is shown below.

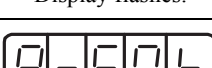

Step	Display after Operation	Keys	Operation
1			Press the MODE/SET Key to select the parameter setting. If a parameter other than Pn50A is displayed, press the UP or DOWN Key to set Pn50A.
2			Press the DATA/SHIFT Key for approximately one second to display the current data of Pn50A. (/S-ON is allocated on CN1-40.)
3			Press the UP key to set to the value on the far right "1" (Pn50A.0 = 1). (Sequence input signals can be freely set.)
4			Press the DATA/SHIFT Key to select the second digit from the right. Press the UP key to set to "5." (Changes the allocation of /S-ON from CN1-40 to CN1-45.)
5	 Display flashes.		Press the MODE/SET Key. The data flashes and is saved.
6			Press the DATA/SHIFT Key for approximately one second to return to the display Pn50A.
7			Press the UP key to display Pn50B.
8			Press the DATA/SHIFT Key for approximately one second to display the current data of Pn50B. (/P-CL is allocated on CN1-45.)
9			Press the DATA/SHIFT Key to select the third digit from the right. Press the UP Key to set "0." (Changes the allocation of /P-CL from CN1-45 to CN1-40.)
10	 Display flashes.		Press the MODE/SET Key. The value flashes and is saved.
11			Press the DATA/SHIFT Key for approximately one second to return to the display Pn50B. /S-ON is mapped on CN1-45, and /P-CL is mapped on CN1-40.
12	To enable the change in the setting, turn the power OFF and ON again.		

<Input signal polarities>

Input signal polarities are as follows when sequence input circuit is connected to a sink circuit. If connected to a source circuit, polarities are reversed. For details, refer to 3.4.2 *Sequence Input Circuit*.

Signal	Level	Voltage Level	Contact
ON	Low (L) level	0 V	Close
OFF	High (H) level	24 V	Open

(4) Checking Input Signals

Input signal status can be checked using the input signal monitor (Un005). As for the input signal monitor (Un005), refer to 8.4 *Monitoring Input Signals*.

3.3.2 Output Signal Allocations

Output signals can be allocated to I/O signal connectors (CN1) in accordance with the parameter setting of Pn50E, Pn50F, Pn510, and Pn512.

(1) Checking Factory Settings

Factory settings can be checked using the following parameters.

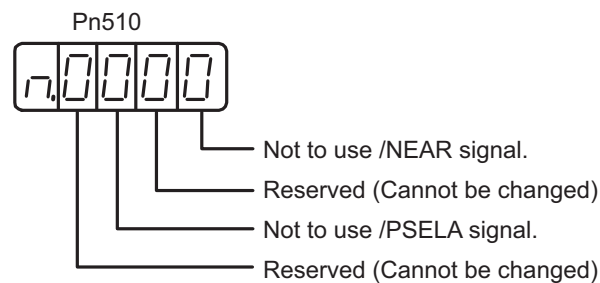
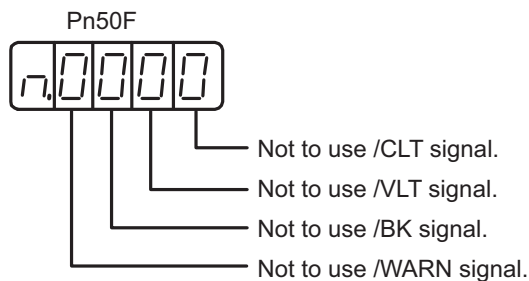
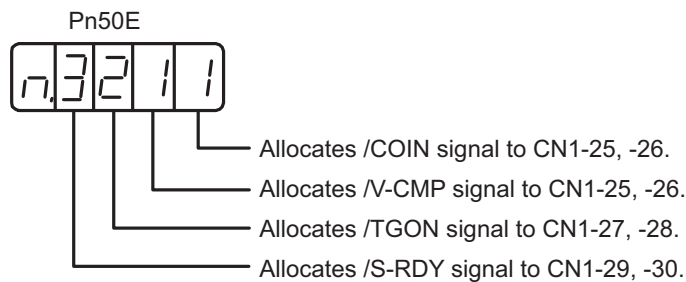

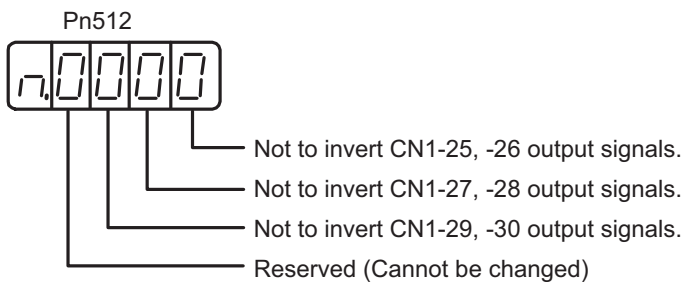

(2) Changing Output Signal Allocations



IMPORTANT

- The signals not detected are considered as "Invalid." For example, Positioning Completion (/COIN) signal in speed control is "Invalid."
- Inverting the polarity of the brake signal (/BK), i.e. positive logic, will prevent the holding brake from working in case of its signal line disconnection. If this setting is absolutely necessary, check the operation and confirm that there are no safety problems.
- When two or more signals are allocated to the same output circuit, a signal is output with OR logic circuit.

Output signals are allocated as shown in the following table.

Refer to the *Interpreting the Output Signal Allocation Tables* and change the allocations accordingly.

<Interpreting the Output Signal Allocation Tables>

The parameter set values to be used are shown. Signals are allocated to CN1 pins according to the selected set values. Values in cells in bold lines are the factory settings.

Output Signal Names and Parameters	Output Signal	CN1 Pin Numbers			Invalid (not use)
		25 (26)	27 (28)	29 (30)	
Positioning Completion Pn50E.0	/COIN	1	2	3	0

Output Signal Names and Parameters	Output Signal	CN1 Pin Numbers			Invalid (not use)
		25 (26)	27 (28)	29 (30)	
Positioning Completion Pn50E.0	/COIN	1	2	3	0
Speed Coincidence Detection Pn50E.1	/V-CMP	1	2	3	0
Rotation Detection Pn50E.2	/TGON	1	2	3	0
Servo Ready Pn50E.3	/S-RDY	1	2	3	0
Torque Limit Detection Pn50F.0	/CLT	1	2	3	0
Speed Limit Detection Pn50F.1	/VLT	1	2	3	0
Brake Pn50F.2	/BK	1	2	3	0

(cont'd)

Output Signal Names and Parameters	Output Signal	CN1 Pin Numbers			Invalid (not use)
		25 (26)	27 (28)	29 (30)	
Warning Pn50F.3	/WARN	1	2	3	0
Near Pn510.0	/NEAR	1	2	3	0
Reference Pulse Input Multiplication Switching Output Pn510.2	/PSELA	1	2	3	0
Pn512.0=1	Polarity inversion of CN1-25 (26)			0 (Not invert at factory setting)	
Pn512.1=1	Polarity inversion of CN1-27 (28)				
Pn512.2=1	Polarity inversion of CN1-29 (30)				

(3) Example of Output Signal Allocation

The procedure to set Rotation Detection (/TGON) signal of factory setting to "Invalid" and allocate Brake Interlock (/BK) signal is shown below.

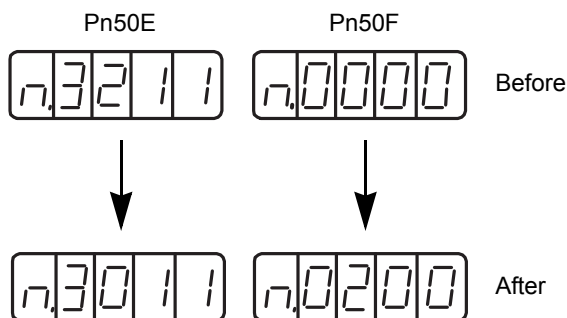

Step	Display after Operation	Keys	Operation
1	Pn50E		Press the MODE/SET Key to select the parameter setting. If a parameter other than Pn50E is displayed, press the UP or DOWN Key to select Pn50E.
2	n.3211		Press the DATA/SHIFT Key for approximately one second to display the current data of Pn50E. (/TGON is allocated on CN1-27 (28).)
3	n.3011		Press the DATA/SHIFT Key to select the third digit from the right. Press the DOWN Key to set "0." (Sets /TGON "Invalid.")
4	n.3011 Display flashes.		Press the MODE/SET Key. The data flashes and is saved.
5	Pn50E		Press the DATA/SHIFT Key for approximately one second to return to the display Pn50E.
6	Pn50F		Press the UP Key to display Pn50F.
7	n.0000		Press the DATA/SHIFT Key for approximately one second to display the current data of Pn50F. (/BK is set to "Invalid.")
8	n.0200		Press the DATA/SHIFT Key to select the third digit from the right. Press the UP Key to set "2." (Allocates /BK to CN1-27 (28).)
9	n.0200 Display flashes.		Press the MODE/SET Key. The value flashes and is saved.
10	Pn50F		Press the DATA/SHIFT Key for approximately one second to return to the display Pn50F. /TGON is set as "Invalid" and /BK is allocated on CN1-27 (28).
11	To enable the change in the setting, turn the power OFF and ON again.		

(4) Checking Output Signals

Output signal status can be checked using the output signal monitor (Un006). As for the output signal monitor (Un006), refer to 8.5 *Monitoring Output Signals*.

3.4 Examples of Connection to Host Controller

This section shows examples of SERVOPACK I/O signal connection to the host controller.

3.4.1 Reference Input Circuit

(1) Analog Input Circuit

CN1 connector terminals, 5-6 (speed reference input) and 9-10 (torque reference input) are explained below. Analog signals are either speed or torque reference signals at the impedance below.

- Reference speed input: Approx. 14 kΩ
- Reference torque input: Approx. 14 kΩ

The maximum allowable voltages for input signals is ±12 V.

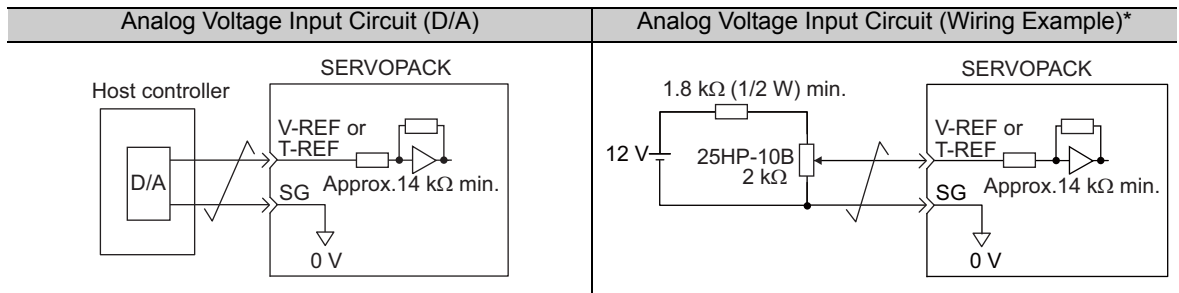

* This wiring example is for forward operation.

(2) Position Reference Input Circuit

CN1 connector terminals, 7-8 (reference pulse input), 11-12 (reference sign input) and 14-15 (clear input) are explained below. The output circuits for the reference pulse and position error clear signal from the host controller can be either a line-driver output or open-collector output. The position reference input circuits are shown below by output type.

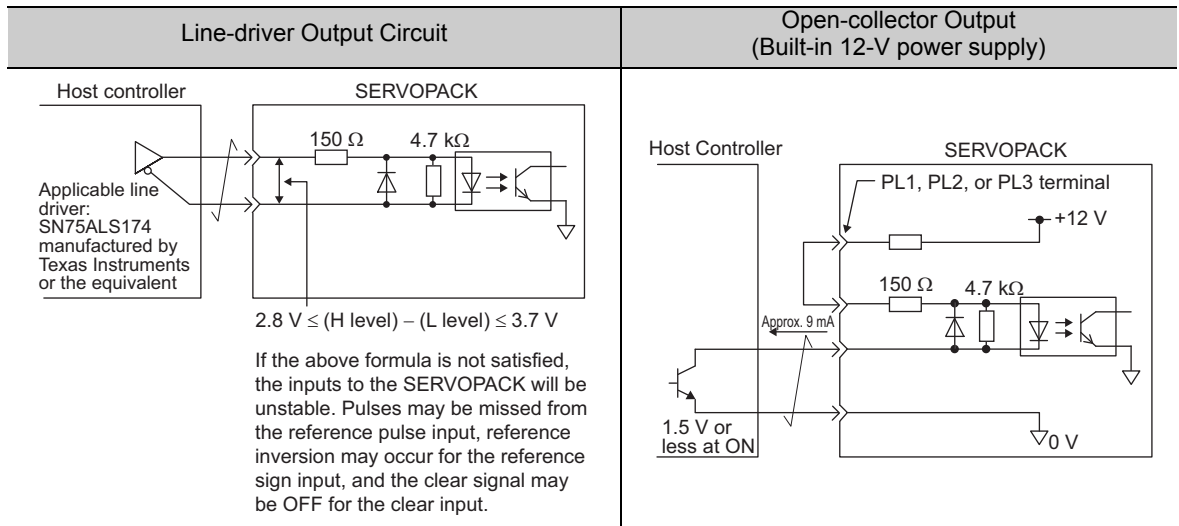



IMPORTANT

- Precaution when host controller uses open collectors with customer-supplied power. Before wiring, confirm that the specifications of the host controller satisfy the values shown in the following table. If these conditions are not satisfied, the SERVOPACK may malfunction.

Pull-up voltage (Vcc)	Pull-up resistance (R1)
24 V	1.8 to 2.7 kΩ
12 V or less	820 Ω to 1.5 kΩ
5 V or less	180 to 470 Ω

Circuit example of open-controller output

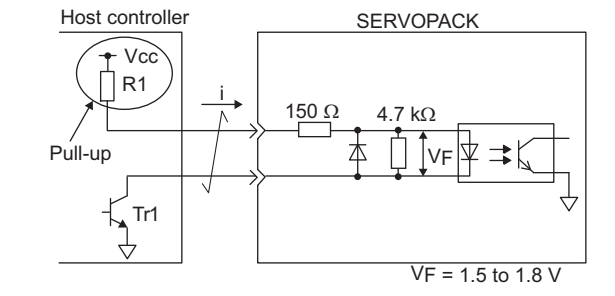

3.4.2 Sequence Input Circuit

(1) Photocoupler Input Circuit

CN1 connector terminals 40 to 47 are explained below.

The sequence input circuit interface is connected through a relay or open-collector transistor circuit. When connecting through a relay, use a low-current relay. If a low-current relay is not used, a faulty contact may result.

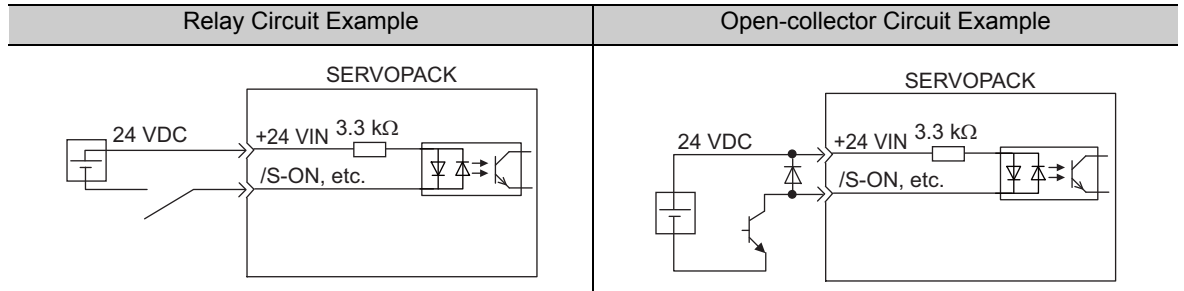

Note: The 24 VDC external power supply capacity must be 50 mA minimum.

For SEN input signal circuit, refer to 5.9.2 *Absolute Data Request Signal (SEN)*.

The SERVOPACK's input circuit uses bidirectional photocoupler. Select either the sink circuit or the source circuit according to the specifications required for each machine.

- Note:
- The connection examples in 3.2.3 to 3.2.5 show sink circuits.
 - The ON/OFF polarity differs between when a sink circuit is connected and when a source circuit is connected.

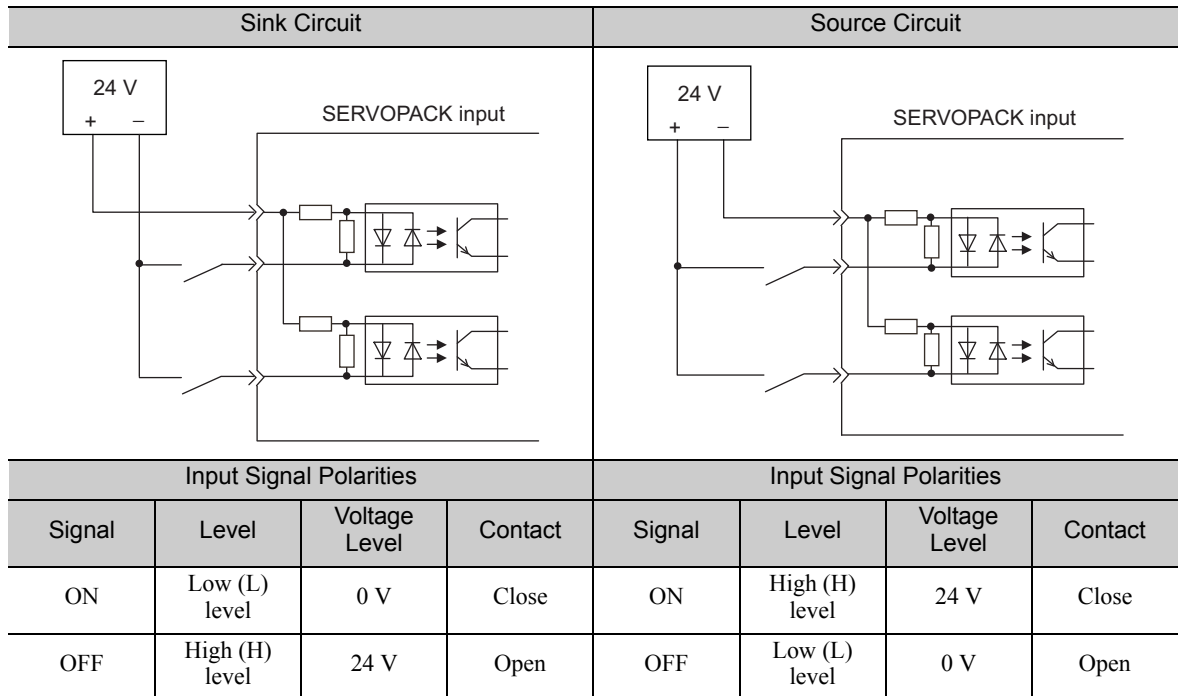

(2) Safety Input Circuit

As for wiring input signals for safety function, input signals make common 0 V. It is necessary to make an input signal redundant.

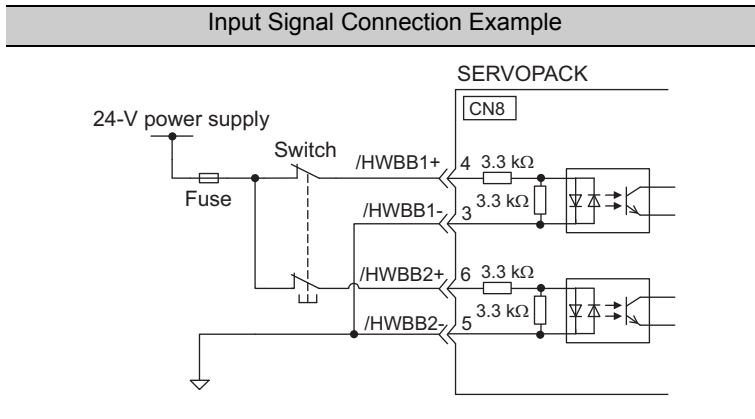

3.4.3 Sequence Output Circuit

Four types of SERVOPACK output circuit are available.

 IMPORTANT	<p>Incorrect wiring or incorrect voltage application to the output circuit may cause short-circuit.</p> <p>If a short-circuit occurs as a result of any of these causes, the holding brake will not work. This could damage the machine or cause an accident resulting in death or injury.</p>
---	--

(1) Open-collector Output Circuit

CN1 connector terminals 37 to 39 (alarm code output) are explained below.

Alarm code signals (ALO1, ALO2, ALO3) are output from open-collector transistor output circuits. Connect an open-collector output circuit through a photocoupler, relay or line receiver circuit.

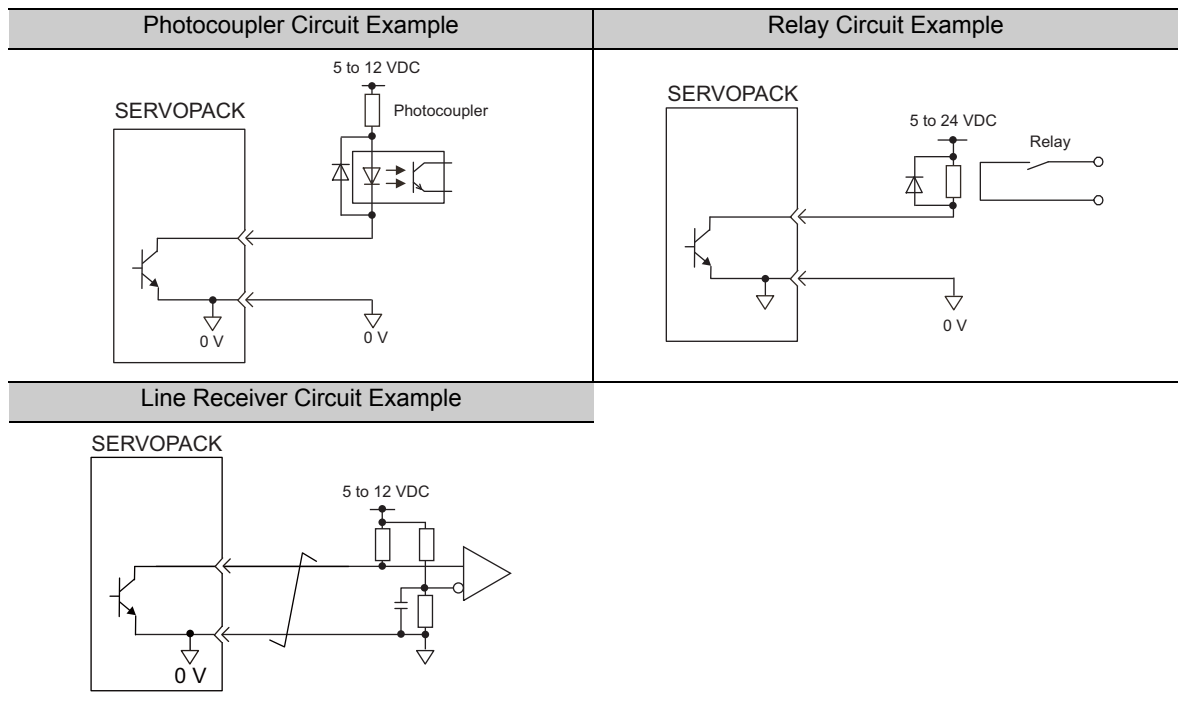

Note: The maximum allowable voltage and maximum current capacity for open-collector output circuits are as follows.

- Voltage: 30 VDC
- Current: 20 mA DC

(2) Photocoupler Output Circuit

Photocoupler output circuits are used for servo alarm (ALM), servo ready (/S-RDY), and other sequence output signal circuits. Connect a photocoupler output circuit through a relay or line receiver circuit.

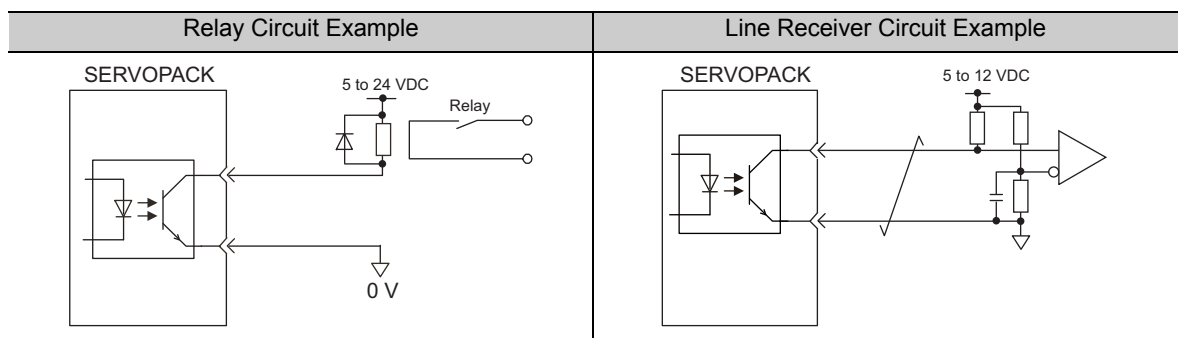

Note: The maximum allowable voltage and the allowable range of current capacity for photocoupler output circuits are as follows.

- Voltage: 30 VDC
- Current: 5 to 50 mA DC

(3) Line Driver Output Circuit

CN1 connector terminals, 33-34 (phase-A signal), 35-36 (phase-B signal), and 19-20 (phase-C signal) are explained below.

These terminals output the following signals via the line-driver output circuits.

- Output signals for which encoder serial data is converted as two phases pulses (PAO, /PAO, PBO, /PBO)
- Origin pulse signals (PCO, /PCO)

Connect the line-driver output circuit through a line receiver circuit at the host controller.

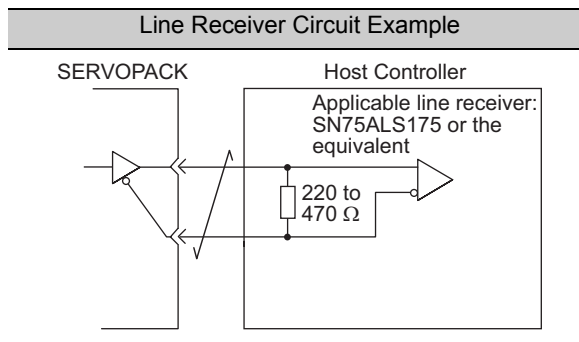

(4) Safety Output Circuit

The external device monitor (EDM1) for safety output signals is explained below.

A configuration example for the EDM1 output signal is shown in the following diagram.

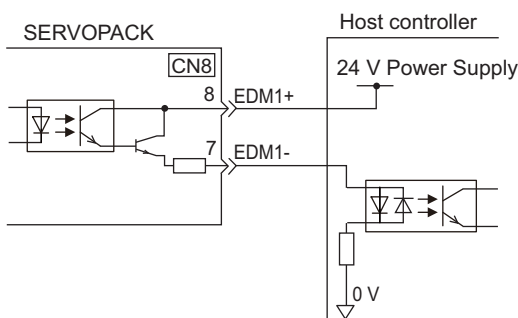

■ Specifications

Type	Signal Name	Pin No.	Output Status	Meaning
Output	EDM1	CN8-8 CN8-7	ON	Both the /HWBB1 and /HWBB2 signals are working normally.
			OFF	The /HWBB1 signal, the /HWBB2 signal, or both are not working normally.

Electrical characteristics of EDM1 signal are as follows.

Items	Characteristic	Remarks
Maximum Allowable Voltage	30 VDC	—
Maximum Current	50 mADC	—
Maximum Voltage Drop at ON	1.0 V	Voltage between EDM1+ to EDM1- at current is 50 mA.
Maximum Delay Time	20 ms	Time from the change in /HWBB1 or /HWBB2 until the change in EDM1.

3.5 Encoder Connection

This section describes the encoder signal (CN2) names, functions, and connection examples.

3.5.1 Encoder Signal (CN2) Names and Functions

The following table shows the names and functions of encoder signals (CN2).

Signal Name	Pin No.	Function
PG 5 V	1	Encoder power supply +5 V
PG 0 V	2	Encoder power supply 0 V
BAT (+)*	3	Battery (+)
BAT (-)*	4	Battery (-)
PS	5	Serial data (+)
/PS	6	Serial data (-)
Shield	Shell	–

* These do not need to be connected for an incremental encoder.

3.5.2 Encoder Connection Examples

The following diagrams show connection examples of the encoder, the SERVOPACK, and the host controller.

(1) Incremental Encoder

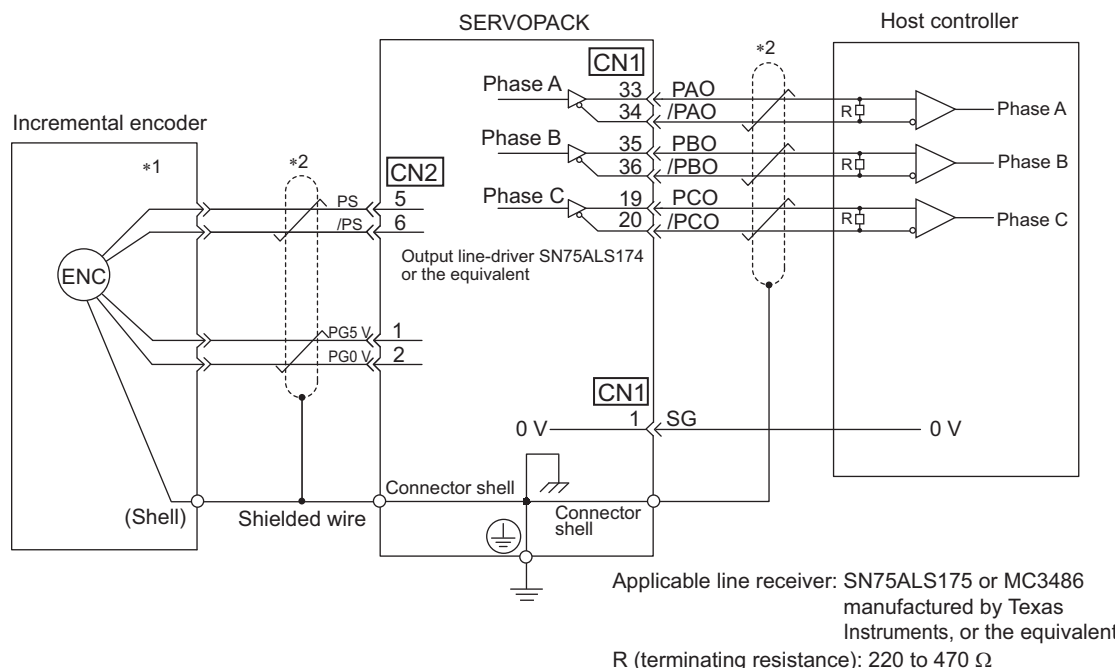

*1. The pin arrangement for wiring connectors varies in accordance with the servomotor that is used.

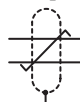
*2.  : represents shielded twisted-pair wires.

(2) Absolute Encoder

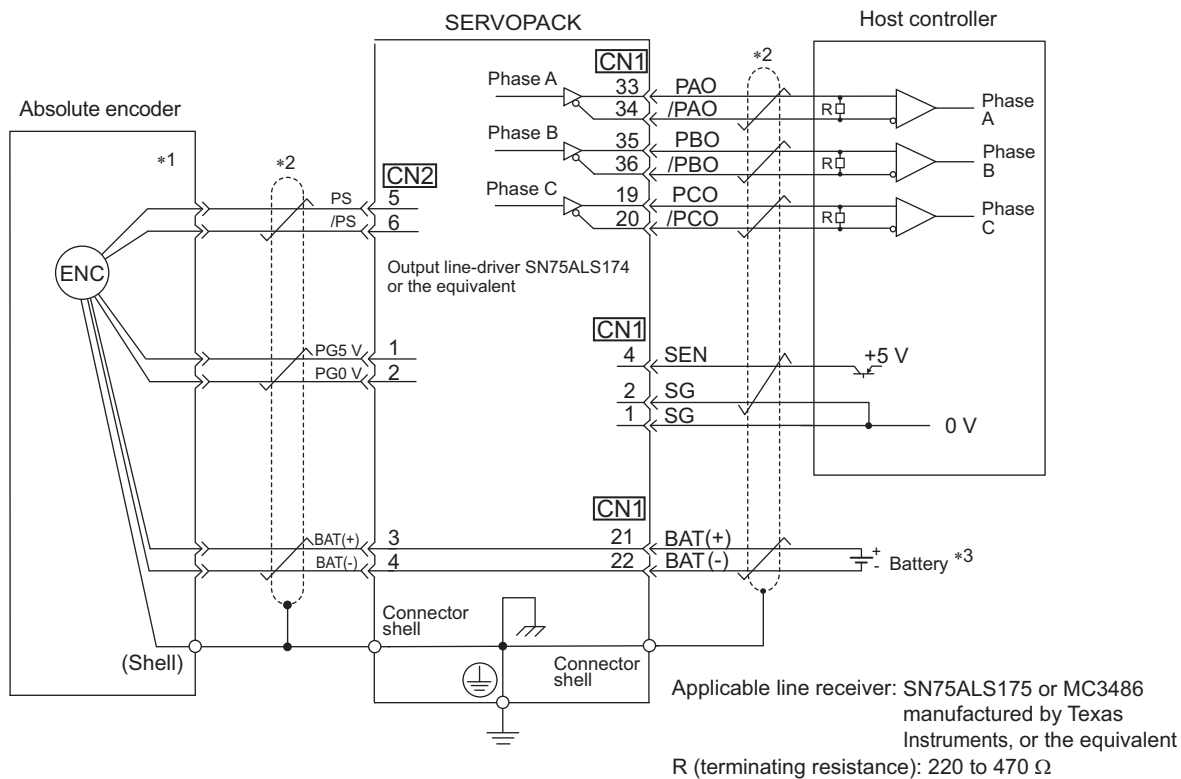

*1. The pin arrangement for wiring connectors varies in accordance with the servomotor that is used.

*2.  : represents shielded twisted-pair wires.

*3. When using an absolute encoder, provide power by installing an encoder cable with a JUSP-BA01-E Battery Case or install a battery on the host controller.

3.6 Connecting Regenerative Resistors

If the built-in regenerative resistor is insufficient, connect an external regenerative resistor by one of the following methods and set the regenerative resistor capacity (Pn600). As for precautions on selecting a regenerative resistor and its specifications, refer to *Σ-V Series Product Catalog* (No.: KAEP S800000 42).

⚠ WARNING

- Be sure to connect the regenerative resistor correctly. Do not short-circuit between B1/⊕ and B2. Doing so may result in fire or damage to the regenerative resistor or SERVOPACK.

3.6.1 Connecting Regenerative Resistors

The following instructions show how to connect the regenerative resistors and SERVOPACKs.

- (1) SERVOPACKs: Model SGD_V-R70F, -R90F, -2R1F, -2R8F, -R70A, -R90A, -1R6A, -2R8A

Connect an external regenerative resistor between the B1/⊕ and B2 terminals on the SERVOPACK. After connecting a resistor, select the capacity. For more information on how to set the capacity of regenerative resistors, refer to 3.6.2 *Setting Regenerative Resistor Capacity*.

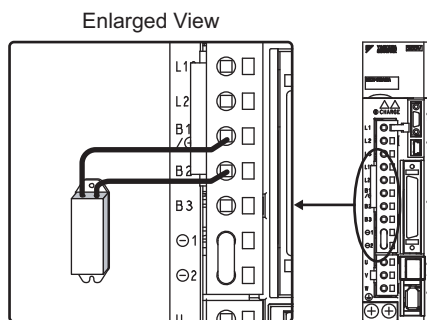

- (2) SERVOPACKs: Model SGD_V-3R8A, -5R5A, -7R6A, -120A, -180A, -200A, -330A, -1R9D, -3R5D, -5R4D, -8R4D, -120D, -170D

Disconnect the wiring between the SERVOPACK's B2 and B3 terminals and connect an external regenerative resistor between the B1/⊕ and B2 terminals. After connecting the resistor, select the capacity. For more information on how to set the capacity of regenerative resistors, refer to 3.6.2 *Setting Regenerative Resistor Capacity*.

Note: Be sure to take out the lead wire between the B2 and B3 terminals.

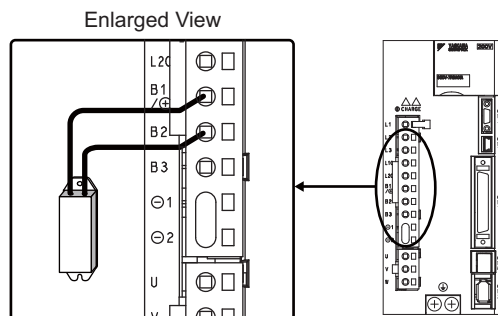

(3) SERVOPACKs: Model SGDV-470A, -550A, -590A, -780A, -210D, -260D, -280D, -370D

No built-in regenerative resistor is provided, so the external regenerative resistor is required. The regenerative resistor units are as follows:

Note: The regenerative resistor unit is constructed from a number of resistors.

Main Circuit Power Supply	Applicable SERVOPACK Model SGDV-	Applicable Regenerative Resistor Unit	Resistance (Ω)	Specifications
Three-phase 200 V	470A	JUSP-RA04-E	6.25	Four 25 Ω (220 W) resistors are connected in parallel.
	550A, 590A, 780A	JUSP-RA05-E	3.13	Eight 25 Ω (220 W) resistors are connected in parallel.
Three-phase 400 V	210D, 260D	JUSP-RA18-E	18	Two series of two 18 Ω (220 W) resistors each are connected in parallel.
	280D, 370D	JUSP-RA19-E	14.25	Four series of two 28.5 Ω (220 W) resistors each are connected in parallel.

Connect the B1/⊕ and B2 terminals of the SERVOPACK to the R1 and R2 terminals of the regenerative resistor unit.

When using a regenerative resistor unit, leave Pn600 at its factory setting. Set Pn600 when using a non-YASKAWA external regenerative resistor.

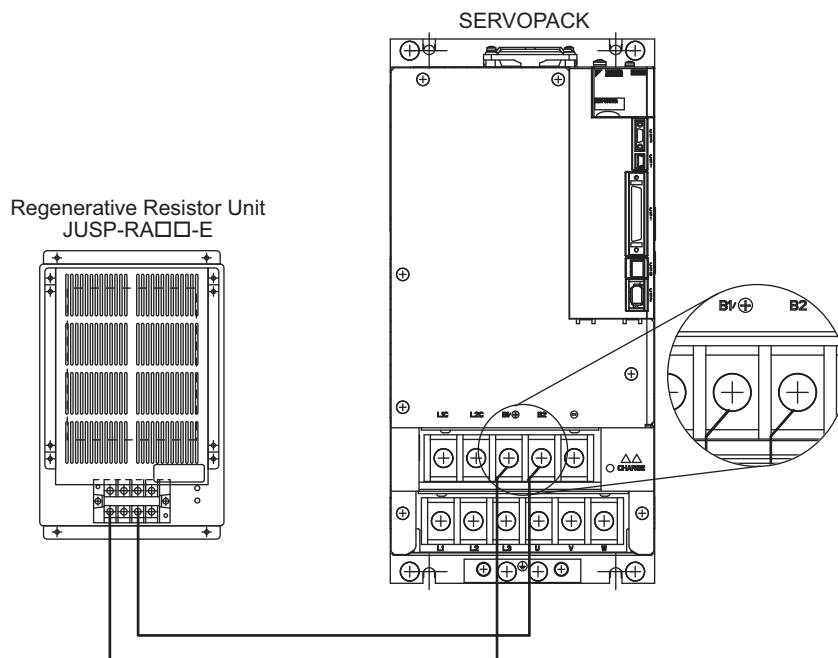

3.6.2 Setting Regenerative Resistor Capacity

When using an external regenerative resistor, set the Pn600 so that the regenerative resistor capacity is equivalent to the resistor capacity.

WARNING

- If parameter Pn600 is set to 0 while an external regenerative resistor is connected, the regenerative overload alarm (A.320) may not be detected. If the regenerative overload alarm (A.320) is not detected correctly, the external regenerative resistor may be damaged and an injury or fire may result.

Pn600	Regenerative Resistor Capacity				Classification
	Setting Range	Unit	Factory Setting	When Enabled	
	0 to SERVOPACK capacity	10 W	0	Immediately	

Be sure to set the regenerative resistor capacity (Pn600) to a value that is in accordance with the allowable capacity of the actual external regenerative resistor being used.

- Note 1. If Pn600 is not set to the optimum value, alarm A.320 will occur.
2. When set to the factory setting (Pn600 = 0), the SERVOPACK's built-in resistor or Yaskawa's regenerative resistor unit has been used.

The setting will vary with the cooling method of external regenerative resistor:

- For natural convection cooling: Set the value to a maximum 20% of the actually installed regenerative resistor capacity (W).
- For forced convection cooling: Set the value to a maximum 50% of the actually installed regenerative resistor capacity (W).

Example: Set 20 W (100 W × 20%) for the 100-W external regenerative resistor with natural convection cooling method:
Pn600 = 2 (unit: 10 W)



IMPORTANT

- When the external regenerative resistors for power are used at the rated load ratio, the resistor temperature increases to between 200 °C and 300 °C. The resistors must be used at or below the rated values. Check with the manufacturer for the resistor's load characteristics.
- For safety, use the external regenerative resistors with thermostats.

3.7 Noise Control and Measures for Harmonic Suppression

This section describes the wiring for noise control and the DC reactor for harmonic suppression.

3.7.1 Wiring for Noise Control



IMPORTANT

- Because the SERVOPACK is designed as an industrial device, it provides no mechanism to prevent noise interference.
- The SERVOPACK uses high-speed switching elements in the main circuit. Therefore peripheral devices may receive switching noise. If the equipment is to be used near private houses or if radio interference is a problem, take countermeasures against noise.
- If installation conditions by the EMC directive must be met, refer to *2.4 EMC Installation Conditions in Σ -V Series User's Manual Setup Rotational Motor* (No.: SIEP S800000 43).

The SERVOPACK uses microprocessors. Therefore it may receive switching noise from peripheral devices.

To prevent the noise from the SERVOPACK or the peripheral devices from causing a malfunction of any one of these devices, take the following precautions against noise as required.

- Position the input reference device and noise filter as close to the SERVOPACK as possible.
- Always install a surge absorber in the relay, solenoid and electromagnetic contactor coils.
- Do not bundle or run the main circuit cables together with the I/O signal cables or the encoder cables in the same duct. Keep the main circuit cables separated from the I/O signal cables and the encoder cables with a gap of at least 30 cm.
- Do not share the power supply with an electric welder or electrical discharge machine. When the SERVOPACK is placed near a high-frequency generator, install a noise filter on the input side of the main circuit power supply cables and control power supply cables. As for the wiring of noise filter, refer to *(1) Noise Filter* shown below.
- Take the grounding measures correctly. As for the grounding, refer to *(2) Correct Grounding*.

(1) Noise Filter

The SERVOPACK has a built-in microprocessor (CPU), so protect it from external noise as much as possible by installing a noise filter in the appropriate place.

The following is an example of wiring for noise control.

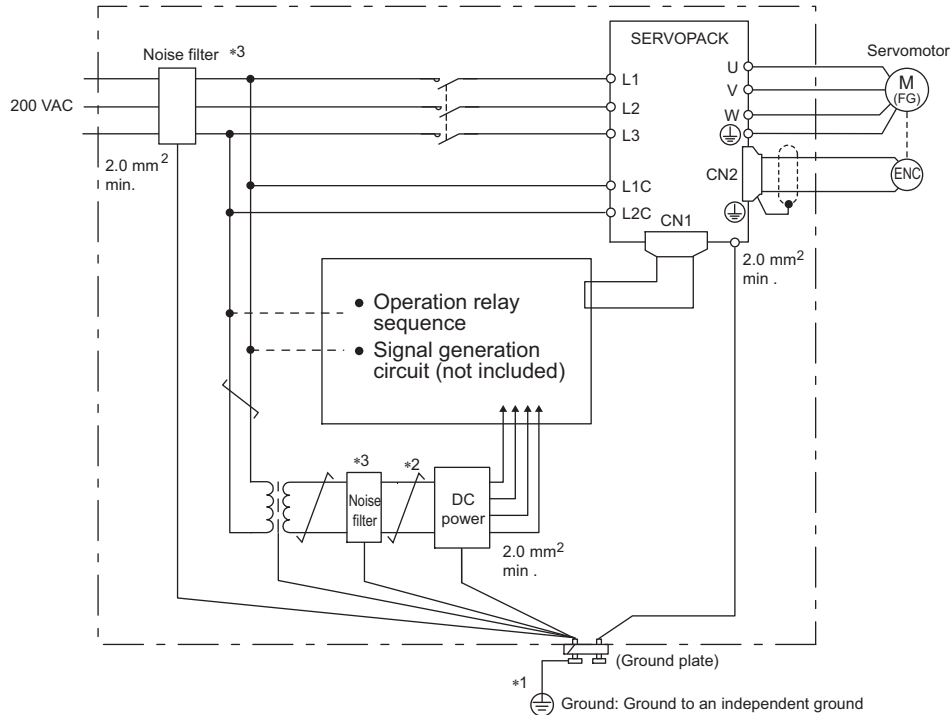

*1. For ground wires connected to the ground plate, use a thick wire with a thickness of at least 2.0 mm^2 (preferably, plain stitch cooper wire).

*2.  should be twisted-pair wires.

*3. When using a noise filter, follow the precautions in 3.7.2 *Precautions on Connecting Noise Filter*.

(2) Correct Grounding

Take the following grounding measures to prevent the malfunction due to noise.

■ Grounding the Motor Frame

Always connect servomotor frame terminal FG to the SERVOPACK ground terminal \oplus . Also be sure to ground the ground terminal \oplus .

If the servomotor is grounded via the machine, a switching noise current will flow from the SERVOPACK main circuit through servomotor stray capacitance. The above grounding is required to prevent the adverse effects of switching noise.

■ Noise on the I/O Signal Cable

If the I/O signal cable receives noise, ground the 0 V line (SG) of the I/O signal cable. If the servomotor main circuit cable is accommodated in a metal conduit, ground the conduit and its junction box. For all grounding, ground at one point only.

3.7.2 Precautions on Connecting Noise Filter

This section describes the precautions on installing a noise filter.

(1) Noise Filter Brake Power Supply

Use the following noise filter at the brake power input for 400-W or less servomotors with holding brakes.

MODEL: FN2070-6/07 (Manufactured by SCHAFFNER Electronic.)

(2) Precautions on Using Noise Filters

Always observe the following installation and wiring instructions.

 IMPORTANT	<p>Some noise filters have large leakage currents. The grounding measures taken also affects the extent of the leakage current. If necessary, select an appropriate leakage current detector or leakage current breaker taking into account the grounding measures that are used and leakage current from the noise filter. Contact the manufacturer of the noise filter for details.</p>
---	---

Do not put the input and output lines in the same duct or bundle them together.

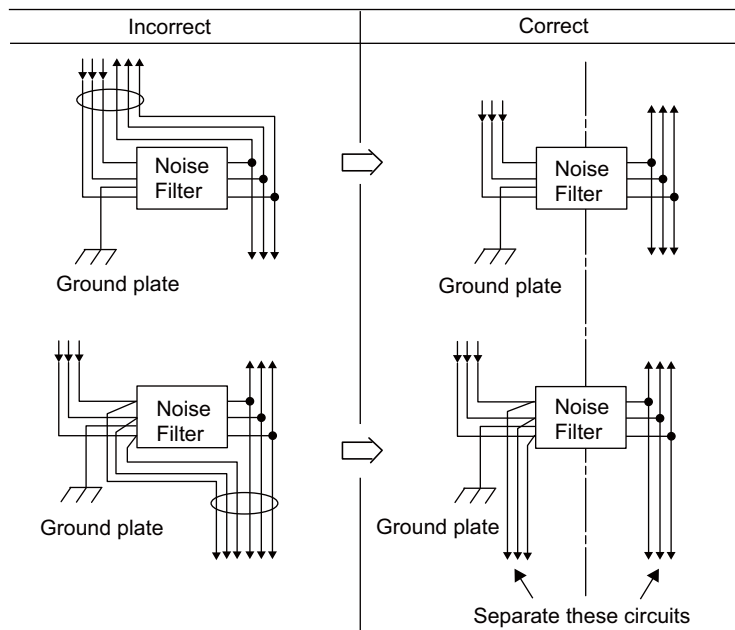

Separate the noise filter ground wire from the output lines.

Do not accommodate the noise filter ground wire, output lines and other signal lines in the same duct or bundle them together.

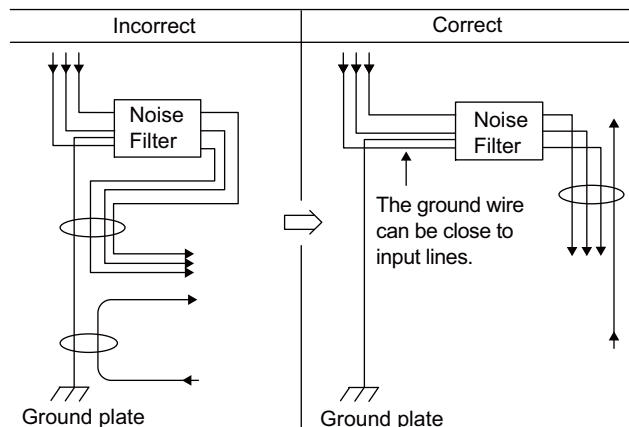

Connect the noise filter ground wire directly to the ground plate.
Do not connect the noise filter ground wire to other ground wires.

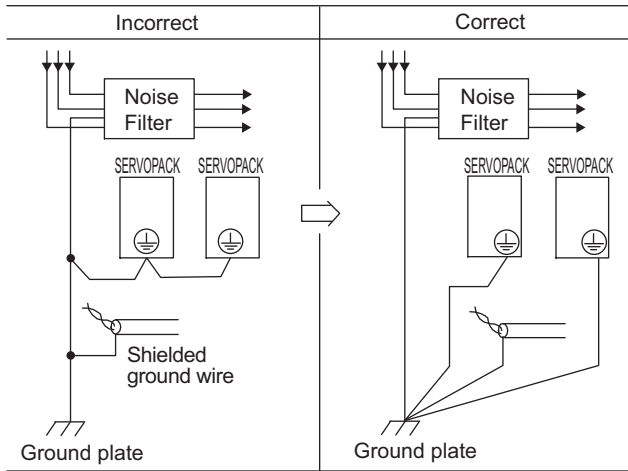

If a noise filter is located inside a control panel, first connect the noise filter ground wire and the ground wires from other devices inside the control panel to the ground plate for the control panel, then ground the plates.

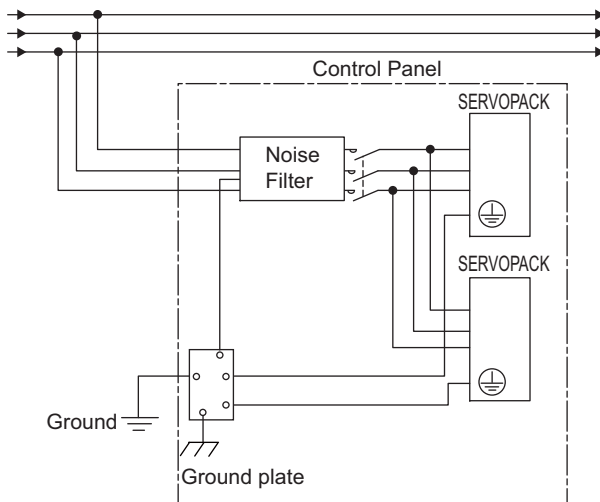

3.7.3 Connecting a Reactor for Harmonic Suppression

The SERVOPACK has reactor connection terminals for power supply harmonic suppression that can be used as required. Refer to *Σ-V Series Product Catalog* (No.: KAEP S800000 42) for precautions on selecting an AC or DC reactor and its specifications.

Connect a reactor as shown in the following diagram.

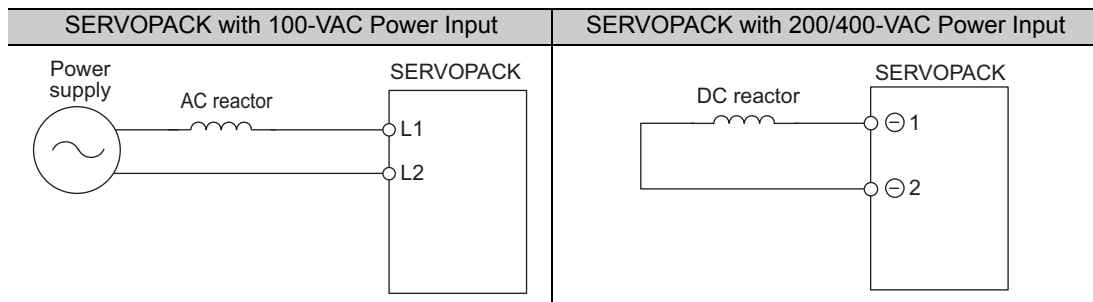

- Note 1. Connection terminals for DC reactor ⊖1 and ⊖2 are short-circuited at shipment. Remove the lead wire for short-circuit, and connect a DC reactor.
 2. Reactors are not included. (Sold separately.)
 3. DC reactors cannot be connected to SERVOPACKs with a single-phase 100-V power input.

Trial Operation

4.1	Inspection and Checking before Trial Operation	4-2
4.2	Trial Operation for Servomotor without Load	4-2
4.3	Trial Operation for Servomotor without Load from Host Reference	4-3
4.3.1	Inspecting Connection and Status of Input Signals	4-5
4.3.2	Trial Operation in Speed Control	4-8
4.3.3	Trial Operation under Position Control from the Host Controller with the SERVOPACK Used for Speed Control	4-9
4.3.4	Trial Operation in Position Control	4-10
4.4	Trial Operation with the Servomotor Connected to the Machine	4-11
4.5	Trial Operation of Servomotor with Brakes	4-12
4.6	Test Without Motor Function	4-13
4.6.1	Motor Information	4-13
4.6.2	Motor Position and Speed Responses	4-14
4.6.3	Limitations	4-15
4.6.4	Operator Displays during Testing without Motor	4-16

4.1 Inspection and Checking before Trial Operation

To ensure safe and correct trial operation, inspect and check the following items before starting trial operation.

(1) Servomotors

Inspect and check the following items, and take appropriate measures before performing trial operation if any problem exists.

- Are all wiring and connections correct?
- Are all nuts and bolts securely tightened?
- If the servomotor has an oil seal, is the seal undamaged and is the servomotor oiled?

Note: When performing trial operation on a servomotor that has been stored for a long period of time, perform the inspection according to the procedures described in *1.7 Inspection and Maintenance*.

(2) SERVOPACKs

Inspect and check the following items, and take appropriate measures before performing trial operation if any problem exists.

- Are all wiring and connections correct?
- Is the correct power supply voltage being supplied to the SERVOPACK?

4.2 Trial Operation for Servomotor without Load

For the trial operation for servomotor without load, refer to *Σ-V Series User's Manual, Setup, Rotational Motor* (No.: SIEP S800000 43).

4.3 Trial Operation for Servomotor without Load from Host Reference

Check the following items before performing trial operation of the servomotor without load from host reference.

- Check that servomotor operation reference input from the host controller to the SERVOPACK and I/O signals are set properly.
- Check that the wiring between the host controller and SERVOPACK and the polarity of the wiring are correct.
- Check that all operation settings for the SERVOPACK are correct.

Perform the trial operation using the following procedure.

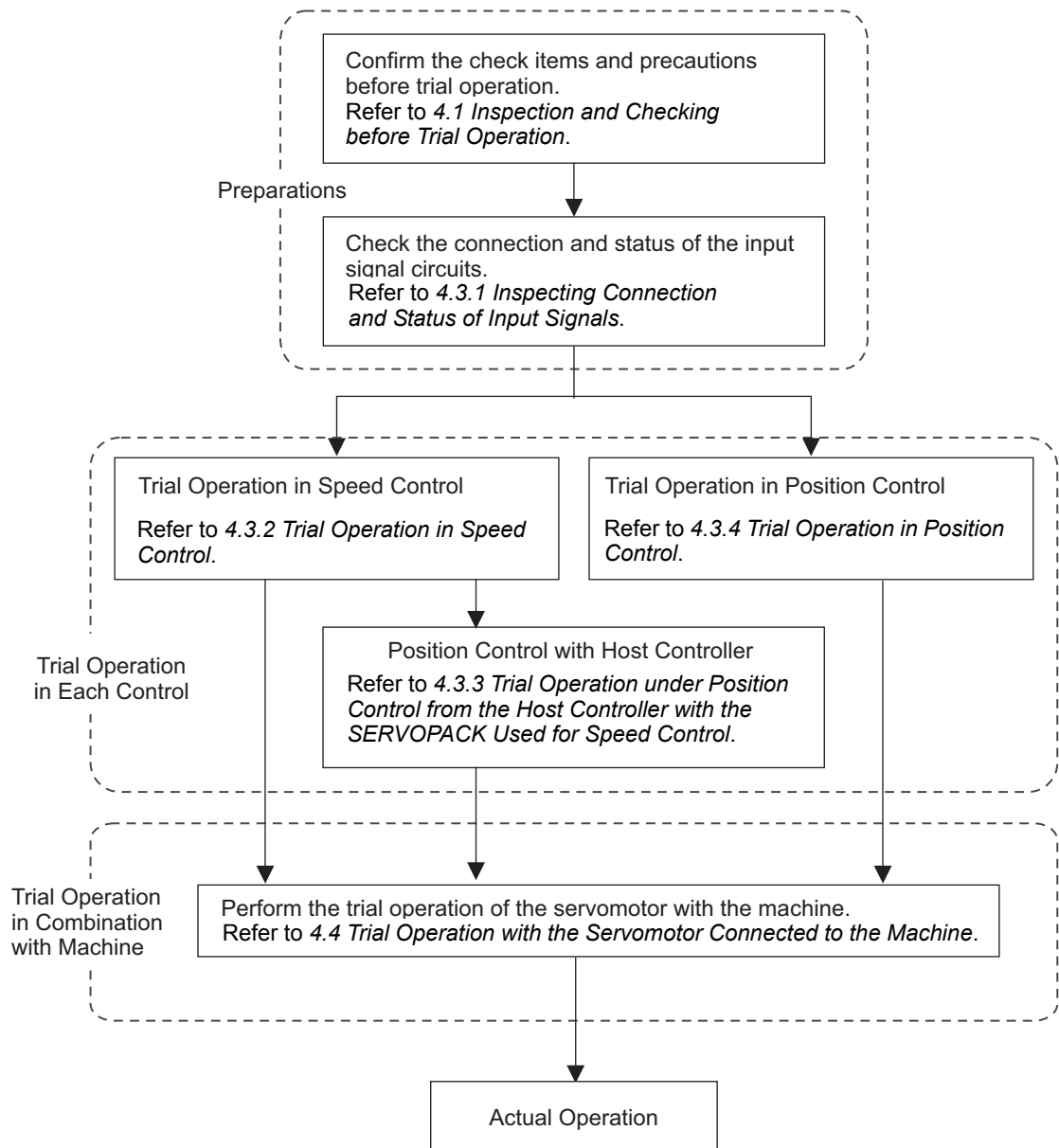

Note: To perform trial operation of a servomotor with a brake, refer to 4.5 *Trial Operation of Servomotor with Brakes*.

 **CAUTION**

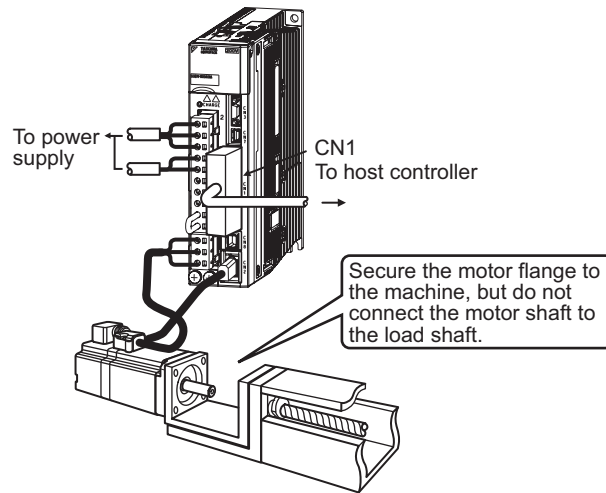

Before performing trial operation of the servomotor alone under references from the host controller, be sure that the servomotor has no load (i.e., the coupling and belt are removed from the servomotor) to prevent unexpected accidents.



4.3.1 Inspecting Connection and Status of Input Signals

Check the items in step 1 before trial operation of the servomotor under speed control and position control references from the host controller.

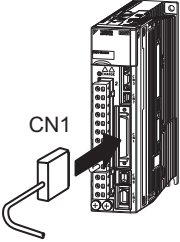
Check the connection and status of input signals using the following procedure.

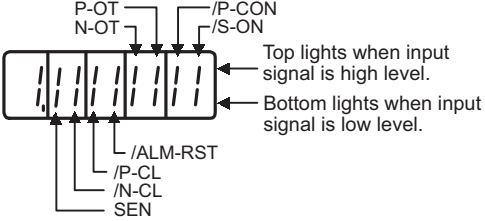
Step	Operation	Reference
1	<p>Connect the necessary input signals to the I/O signal connector (CN1) under the following conditions.</p> <ul style="list-style-type: none"> • It must be possible to input servo ON signal (/S-ON). • The forward run prohibited (P-OT) and reverse run prohibited (N-OT) input signals must be ON (L level) (i.e., the servomotor must be able to run in forward and reverse). <p>Settings: CN1-42 and CN1-43 must be ON (low) or Pn50A.3 and Pn50B.0 must be set to 8 to disable the forward and reverse run prohibited function.</p>  <p>Note:</p> <ul style="list-style-type: none"> • Return the settings to the previous ones after completing trial operation. • Make sure that there is no reference input. • If Pn002.2 is set to 1, the absolute encoder can temporarily be used as an incremental encoder, which makes it possible to perform trial operation of the servomotor without Fn008 and SEN signal settings. <p>Connect a safety function device to CN8 when using the safety function. For the connecting method, refer to (1) <i>Connecting a Safety Function Device</i>.</p>	<p>Refer to the following connection diagrams.</p> <p>3.2.3 Example of I/O Signal Connections in Speed Control 3.2.4 Example of I/O Signal Connections in Position Control 3.2.5 Example of I/O Signal Connections in Torque Control</p> <p>5.9 Absolute Encoders 5.11 Safety Function 3.2.2 Safety Function Signal (CN8) Names and Functions</p>
2	<p>Connect the connector of the host controller to the I/O signal connector (CN1).</p>	
3	<p>Turn ON the SERVOPACK power and make sure that the panel operator display is as shown below.</p>  <p>Check the input signal using the input signal monitor (Un005) from the panel operator. If the display is not the same as shown below, correct the input signal setting.</p>  <p>Input signal LED display</p>  <p>Top lights when input signal is high level. Bottom lights when input signal is low level.</p> <p>Note:</p> <ul style="list-style-type: none"> • If an absolute encoder is being used, turn ON the SEN signal. The servomotor will not turn ON when only the servo ON signal (/S-ON) is input. • When the SEN signal is checked using the monitor display, the top of the LED will light because the SEN signal is high when ON. • Input signals can be also checked using wiring check function of SigmaWin+. 	<p>8.4 Monitoring Input Signals 3.3.1 Input Signal Allocations</p>

(cont'd)

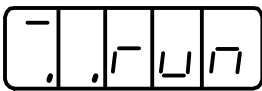
Step	Operation	Reference
4	Input the /S-ON signal, then make sure that the display of the panel operator is as shown below. <div style="text-align: center; margin: 10px 0;">  </div> If an alarm display appears, correct it according to <i>10.1 Alarm Displays</i> . If the cause of alarm is not corrected, the servo ON signal cannot be input and the servomotor cannot be turned on.	10.1 Alarm Displays
5	This completes all preparations for trial operation. Perform trial operation in each control method.	<i>4.3.2 Trial Operation in Speed Control</i> <i>4.3.3 Trial Operation under Position Control from the Host Controller with the SERVO-PACK Used for Speed Control</i> <i>4.3.4 Trial Operation in Position Control</i>

(1) Connecting a Safety Function Device

There are two types of the safety function's jumper connectors that are attached to SERVOPACKs. You must remove the safety function's jumper connector before connecting a safety function device. The connection method depends on the connector type that is used. Read the following procedures well before you attach a safety function device.

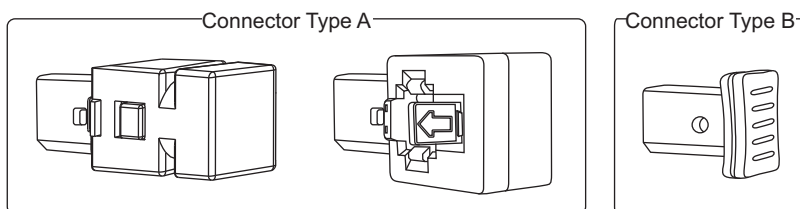

Use the following procedures to attach safety function devices.

■ Connector Type A

1. Remove the servomotor connection terminal connector while pressing the lock.

Applicable SERVOPACKs:

SGDV-R70F, -R90F, -2R1F, -R70A, -R90A, -1R6A, -2R8A, -1R9D, -3R5D, -5R4D

For SERVOPACK models not listed above, it is not necessary to remove the servomotor connection terminal connector. Go to step 2.

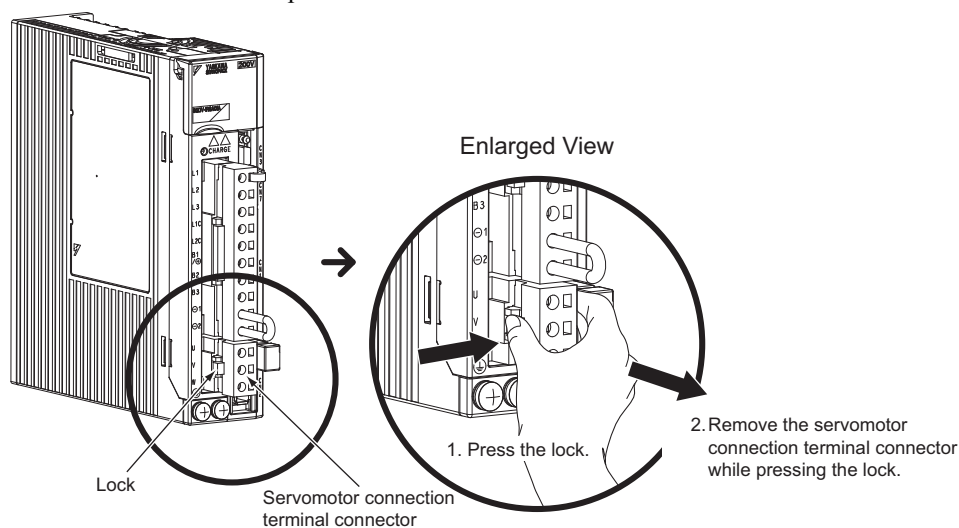

- Slide the lock injector of the safety function's jumper connector to the SERVOPACK side to unlock and remove the safety function's jumper connector.

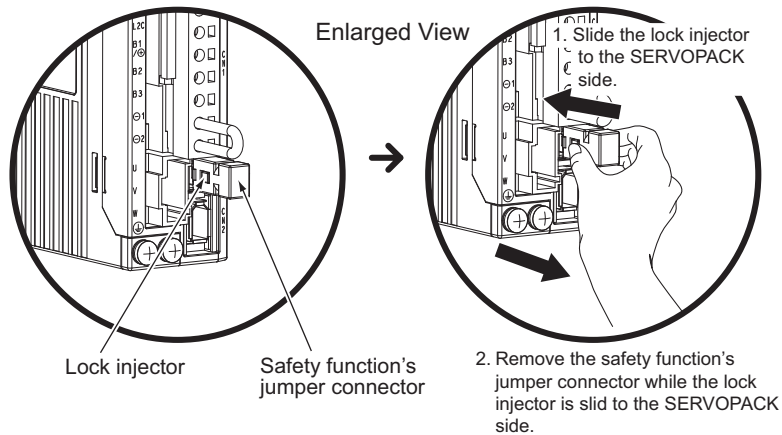

Note: The safety function's jumper connector may be damaged if removed while the lock is still on.

- Connect the safety function device to the safety connector (CN8).

Note: If you do not connect a safety function device, leave the safety function's jumper connector connected to the safety connector (CN8). If the SERVOPACK is used without the safety function's jumper connector connected to CN8, no current will be supplied to the servomotor and no motor torque will be output. In this case, the SERVOPACK will enter a hard wire base block state.

■ Connector Type B

- Remove the safety function's jumper connector from the safety connector (CN8).

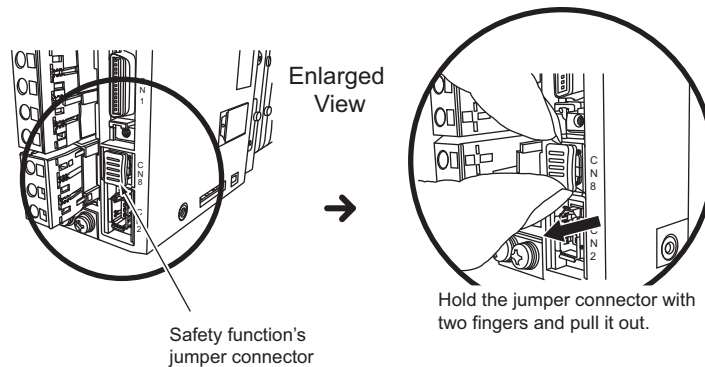

- Connect the safety function device to the safety connector (CN8).

Note: If you do not connect a safety function device, leave the safety function's jumper connector connected to the safety connector (CN8). If the SERVOPACK is used without the safety function's jumper connector connected to CN8, no current will be supplied to the servomotor and no motor torque will be output. In this case, the SERVOPACK will enter a hard wire base block state.

4.3.2 Trial Operation in Speed Control

Perform the following steps for trial operation in speed control. The steps are specified on the condition that input signal wiring for the speed control has been completed according to 4.3.1 *Inspecting Connection and Status of Input Signals*.

Step	Operation	Reference
1	Recheck the power supply and the input signal circuits, and turn ON the SERVO-PACK control power supply.	3.2.3 <i>Example of I/O Signal Connections in Speed Control</i>
2	Adjust the speed reference input gain (Pn300).	5.3.1 <i>Basic Settings for Speed Control</i>
3	Turn ON the main circuit power supply of the SERVOPACK.	–
4	Check that speed reference input (the voltage between V-REF and SG) is 0 V, and turn ON the servo ON (/S-ON) input signal. Note: If the servomotor rotates at a very low speed with the speed reference input at 0 V, adjust the reference offset so that the servomotor will not rotate.	5.3.2 <i>Reference Offset Adjustment</i>
5	Gradually increase the voltage of the speed reference input (i.e., the voltage between V-REF and SG) from 0 V. Note: The factory setting is 6 V at the rated speed.	5.3.1 <i>Basic Settings for Speed Control</i>
6	Check the speed reference value using the monitor display (Un001).	8.1 <i>List of Monitor Displays</i>
7	Check the motor rotating speed using the monitor display (Un000).	8.1 <i>List of Monitor Displays</i>
8	Check that the values in step 6 and step 7 (Un001 and Un000) are equal to each other.	–
9	Check the motor rotation direction. Note: To switch the motor rotation direction without changing the polarity of the analog speed reference, refer to 5.2.2 <i>Servomotor Rotation Direction</i>	5.2.2 <i>Servomotor Rotation Direction</i>
10	Return the speed reference input to 0 V.	–
11	Turn OFF the servo ON signal (/S-ON).	–

4.3.3 Trial Operation under Position Control from the Host Controller with the SERVOPACK Used for Speed Control

To operate the SERVOPACK in speed control under the position control from the host controller, check the operation of the servomotor after finishing the trial operation explained in 4.3.2 *Trial Operation in Speed Control*.

Step	Operation	Reference
1	Recheck the power supply and the input signal circuits, and turn ON the SERVOPACK control power supply.	3.2.3 <i>Example of I/O Signal Connections in Speed Control</i>
2	Adjust the speed reference input gain (Pn300).	5.3.1 <i>Basic Settings for Speed Control</i>
3	Set the encoder output pulses (Pn212).	5.3.7 <i>Setting Encoder Output Pulse</i>
4	Turn ON the main circuit power supply of the SERVOPACK.	–
5	Check that speed reference input (the voltage between V-REF and SG) is 0 V, and turn ON the servo ON (/S-ON) input signal. Note: If the servomotor rotates at a very low speed with the speed reference input at 0 V, adjust the reference offset so that the servomotor will not rotate.	5.3.2 <i>Reference Offset Adjustment</i>
6	To check the speed of the servomotor, execute a constant speed reference at a low speed through the host controller. Example: Visually check that the servomotor rotates once per second with a speed reference of 60 min^{-1} . Note: If the speed of the servomotor is not correct, check the reference sent by the host controller.	8.1 <i>List of Monitor Displays</i>
7	To check the rotation of the servomotor, execute a simple positioning reference through the host controller. Example: Input a reference that is equivalent to a single rotation of the servomotor. To confirm that the servomotor moved a single rotation, do a visual check or check the rotational angle 1 (Un003 [pulse]) Note: If the rotation of the servomotor is not correct, check the reference sent by the host controller.	8.1 <i>List of Monitor Displays</i>
8	Return the speed reference input to 0 V.	–
9	Turn OFF the servo ON signal (/S-ON).	–

4.3.4 Trial Operation in Position Control

Perform the following steps for trial operation in position control. The steps are specified on the condition that input signal wiring for the position control has been completed according to 4.3.1 *Inspecting Connection and Status of Input Signals*.

Step	Operation	Reference
1	Recheck the power supply and the input signal circuits, and turn ON the SERVOPACK control power supply.	3.2.4 <i>Example of I/O Signal Connections in Position Control</i>
2	Set the reference pulse form with Pn200.0 according to the output pulse form of the host pulse reference form.	5.4.1 <i>Basic Settings for Position Control</i>
3	Set the reference unit, and then set the electronic gear ratio according to the host controller. The electronic gear ratio is set in Pn20E and Pn210.	5.4.4 <i>Electronic Gear</i>
4	Turn ON the main circuit power supply of the SERVOPACK.	—
5	Turn ON the servo ON (/S-ON) input signal.	—
6	Output a low-speed pulse reference for an easy-to-check number of rotations (e.g., one rotation) from the host controller. Note: To ensure safety, set the reference pulse speed so that the motor speed will be around 100 min ⁻¹ .	—
7	Check the number of reference pulses input to the SERVOPACK from the changes in the input reference pulse monitor before and after the reference. The input reference pulse can be checked with Un00C.	—
8	Check the actual number of motor rotations from the changes in the feedback pulse monitor before and after the reference. The feedback pulse can be checked with Un00D.	—
9	Check that step 7 and step 8 satisfy the following formula. $Un00D = Un00C \times (Pn20E/Pn210)$	—
10	Check that the servomotor is rotating in the direction specified by the reference. Note: To switch the motor rotation direction without changing the polarity of the input pulse, refer to 5.2.2 <i>Servomotor Rotation Direction</i> .	5.2.2 <i>Servomotor Rotation Direction</i>
11	Input a pulse reference for a comparatively large number of motor rotations from the host controller so that the servomotor will rotate at a constant speed.	—
12	Check the reference pulse speed input to the SERVOPACK from the input reference pulse speed monitor (min ⁻¹). The input reference pulse speed can be checked with Un007. Note: Obtain Un007 from the following formula (if the model uses a 20-bit encoder). $Un007 = \underbrace{\text{input reference pulse speed [pulses/s]} \times 60}_{\text{Reference input pulse speed}} \times \underbrace{\frac{Pn20E}{Pn210}}_{\text{Electronic gear ratio}} \times \underbrace{\frac{1}{2^{20}(=1048576)}}_{\text{Encoder pulse}}$	—
13	Check the motor rotating speed (min ⁻¹). The motor rotating speed can be checked with Un000.	—
14	Check that the values in step 12 and step 13 (Un007 and Un000) are equal to each other.	—
15	Stop the pulse reference and turn OFF the servo ON signal (/S-ON).	—

4.4 Trial Operation with the Servomotor Connected to the Machine

Perform the following steps for trial operation when the servomotor is connected to the machine. The steps are specified on the condition that trial operation for servomotor without load has been completed in each control method.

 <b style="font-size: 1.2em;">WARNING
<ul style="list-style-type: none"> • Malfunctions that occur after the servomotor is connected to the machine may not only damage the machine, but may also cause an accident resulting in death or injury.

 <b style="font-size: 1.2em;">IMPORTANT	<p>Enable the overtravel signals (P-OT and N-OT) during trial operation with the servomotor connected to the machine to provide a protective function.</p>
---	--

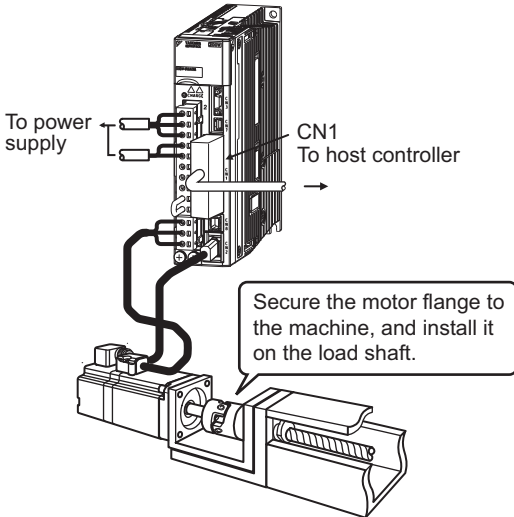
Step	Operation	Reference
1	<p>Turn ON the control power and main circuit power supplies and make the settings for mechanical configuration related to protective function such as safety function, overtravel, and brake.</p> <p>When using the safety function, connect a safety function device to CN8.</p> <p>Note:</p> <ul style="list-style-type: none"> • If you do not connect a safety function device, leave the safety function's jumper connector connected to the safety connector (CN8). If the SERVOPACK is used without the safety function's jumper connector connected to CN8, no current will be supplied to the servomotor and no motor torque will be output. In this case, the SERVOPACK will enter a hard wire base block state. • When a servomotor with brake is used, take advance measures to prevent vibration due to gravity acting on the machine or external forces before checking the brake operation. Check that both servomotor and brake operations are correct. 	<p><i>5.11 Safety Function</i> <i>3.2.2 Safety Function Signal (CN8) Names and Functions</i> <i>5.2.3 Overtravel</i> <i>5.2.4 Holding Brakes</i></p>
2	<p>Set the necessary parameters for control method used.</p>	<p><i>5.3 Speed Control</i> <i>5.4 Position Control</i> <i>5.5 Torque Control</i></p>
3	<p>Connect the servomotor to the machine with coupling, etc., while the power is turned OFF.</p> <div style="text-align: center; margin-top: 20px;">  </div>	-
4	<p>Turn ON the power to the machine (host controller) and then check that the SERVOPACK is servo OFF status. Check again that the protective function in step 1 operates normally.</p> <p>Note: For steps 4 to 8, take advance measures for emergency stop so that the servomotor can stop safely when an error occurs during operation.</p>	<p><i>5.2.5 Stopping Servomotors after /S-ON Turned OFF or Alarm Occurrence</i></p>

(cont'd)

Step	Operation	Reference
5	Perform trial operation with the servomotor connected to the machine, following each section in <i>4.3 Trial Operation for Servomotor without Load from Host Reference</i> . Check that the trial operation is completed with as the trial operation for servomotor without load. Also check the settings for machine such as reference unit.	<i>4.3 Trial Operation for Servomotor without Load from Host Reference</i>
6	Check the settings of parameters for control method used set in step 2 again. Check that the servomotor rotates matching the machine operating specifications.	–
7	Adjust the servo gain and improve the servomotor response characteristics, if necessary. Note: The servomotor will not be broken in completely during the trial operation. Therefore, let the system run for a sufficient amount of additional time to ensure that it is properly broken in.	<i>6 Adjustments</i>
8	Write the parameters set for maintenance in <i>11.4 Parameter Recording Table</i> . Then the trial operation with the servomotor connected to the machine is completed. Note: If the optional digital operator is used, parameters can be saved. SigmaWin+, which is a tool for supporting the servo drive, can then manage the saved parameters in files.	<i>11.4 Parameter Recording Table</i>

4.5 Trial Operation of Servomotor with Brakes

Observe the following precautions when performing a trial operation of servomotor with brake.

- When checking the brake operation, take advance measures to prevent vibration due to gravity acting on the machine or external forces.
- Check the servomotor operation and holding brake operation with the servomotor separated from the machine. If both operations are correct, connect the servomotor to the machine and perform trial operation.

Holding brake operation of the servomotor with brake can be controlled with the brake signal (/BK) of the SERVOPACK.

For wiring on a servomotor with brakes and setting parameters, refer to *5.2.4 Holding Brakes*.



IMPORTANT

Failures caused by incorrect wiring or wrong voltage application in the brake circuit may damage the equipment or cause an accident resulting in death or injury. Follow the procedures and instructions for wiring and trial operation precisely as described in this manual.

4.6 Test Without Motor Function

The test without a motor is used to check the operation of the host controller and peripheral devices by simulating the operation of the servomotor in the SERVOPACK, i.e., without actually operating a servomotor. This function enables you to check wiring, verify the system while debugging, and verify parameters, thus shortening the time required for setup work and preventing damage to the machine that may result from possible malfunctions. The operation of the motor can be checked during performing this function regardless of whether the motor is actually connected or not.

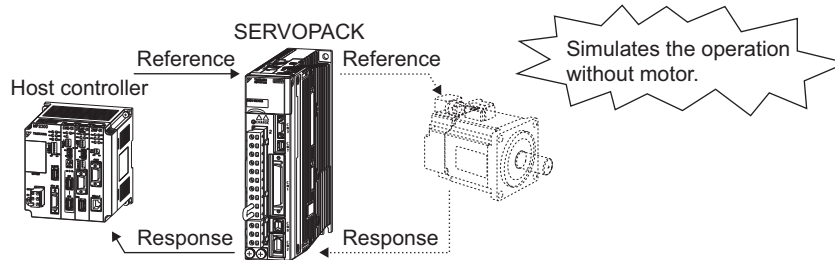

Use Pn00C.0 to enable or disable the test without a motor.

Parameter		Meaning	When Enabled	Classification
Pn00C	n.□□□0 [Factory setting]	Disables the test without a motor.	After restart	Setup
	n.□□□1	Enables the test without a motor.		

4.6.1 Motor Information

The motor information that is used for a test without a motor is given below.

(1) When Motor is Connected

If a motor is connected, the information from the connected motor is used for the motor and encoder scale information. The set values of Pn00C.1 and Pn00C.2 are not used.

(2) When Motor is Not Connected

The information for the virtual motor that is stored in the SERVOPACK is used. The set values of Pn00C.1 and Pn00C.2 are used for the encoder information.

■ Encoder Resolution

The encoder information for the motor is set in Pn00C.1. The setting of Pn00C.1 is not used for an external encoder with fully-closed loop control.

Parameter		Meaning	When Enabled	Classification
Pn00C	n.□□0□ [Factory setting]	Sets the encoder resolution for the test without a motor to 13 bits.	After restart	Setup
	n.□□1□	Sets the encoder resolution for the test without a motor to 20 bits.		

■ Encoder Type

The encoder information for the motor is set in Pn00C.2. An external encoder with fully-closed loop control is always regarded as an incremental encoder.

Parameter		Meaning	When Enabled	Classification
Pn00C	n.□0□□ [Factory setting]	Sets an incremental encoder as an encoder type for the test without a motor.	After restart	Setup
	n.□1□□	Sets an absolute encoder as an encoder type for the test without a motor.		

(3) When External Encoder for Fully-closed Loop Control is Connected

The information from an external encoder is used as the encoder information.

(4) When External Encoder for Fully-closed Loop Control is Not Connected

The encoder information stored in the SERVOPACK is used for the encoder information.

- Resolution: 256
- Incremental encoder

4.6.2 Motor Position and Speed Responses

For the test without a motor, the following responses are simulated for references from the host controller according to the gain settings for position or speed control.

- Servomotor position
- Servomotor speed
- Encoder position

The load model, however, will be a rigid system with the moment of inertia ratio that is set in Pn103.

4.6.3 Limitations

The following functions cannot be used during the test without a motor.

- Regeneration and dynamic brake operation
- Brake output signal (The brake output signal can be checked with the I/O signal monitor function of the SigmaWin+.)
- Items marked with "×" in the following utility function table.

Fn No.	Contents	Can be used or not	
		Motor not connected	Motor connected
Fn000	Alarm history display	○	○
Fn002	JOG operation	○	○
Fn003	Origin search	○	○
Fn004	Program JOG operation	○	○
Fn005	Initializing parameter settings	○	○
Fn006	Clearing alarm history	○	○
Fn008	Absolute encoder multiturn reset and encoder alarm reset	×	○
Fn009	Automatic tuning of analog (speed, torque) reference offset	○	○
Fn00A	Manual servo tuning of speed reference offset	○	○
Fn00B	Manual servo tuning of torque reference offset	○	○
Fn00C	Offset adjustment of analog monitor output	○	○
Fn00D	Gain adjustment of analog monitor output	○	○
Fn00E	Automatic offset-signal adjustment of the motor current detection signal	×	○
Fn00F	Manual offset-signal adjustment of the motor current detection signal	×	○
Fn010	Write prohibited setting	○	○
Fn011	Servomotor model display	○	○
Fn012	Software version display	○	○
Fn013	Multiturn limit value setting change when a multiturn limit disagreement alarm occurs	×	○
Fn014	Resetting configuration error in option modules	○	○
Fn01B	Vibration detection level initialization	×	×
Fn01E	Display of SERVOPACK and servomotor ID	○	○
Fn01F	Display of servomotor ID in feedback option module	○	○
Fn020	Origin setting	×	○
Fn030	Software reset	○	○
Fn200	Tuning-less levels setting	×	×
Fn201	Advanced autotuning	×	×
Fn202	Advanced autotuning by reference	×	×
Fn203	One-parameter tuning	×	×
Fn204	Anti-resonance control adjustment function	×	×
Fn205	Vibration suppression function	×	×
Fn206	EasyFFT	×	×
Fn207	Online vibration monitor	×	×

Note: ○ : Can be used
 × : Cannot be used

4.6.4 Operator Displays during Testing without Motor

The status display changes as shown below to show that the test without a motor is being executed.

(1) Display on Panel Operator

* The test without a motor operation in progress is indicated with *tSt*.



Display	Status
run ⇔ tSt	Power is supplied to the servomotor.
bb ⇔ tSt	Power to the servomotor is OFF.
Pot ⇒ not ⇒ tSt	Forward or reverse run is prohibited.
Pot ⇔ tSt	Forward run is prohibited.
not ⇔ tSt	Reverse run is prohibited.
Hbb ⇔ tSt	In hard-wire base block (safety) state.

Note: The test without a motor status is not displayed during alarm occurs (A.□□□).

(2) Display on Digital Operator

An asterisk (*) is displayed before status display to indicate the test without a motor operation is in progress.

```
* B B      - P R M / M O N -
U n 0 0 0 = 0 0 0 0 0
U n 0 0 2 = 0 0 0 0 0
U n 0 0 8 = 0 0 0 0 0 0 0 0 0 0
U n 0 0 D = 0 0 0 0 0 0 0 0 0 0
```

(Example: Status of power to the servomotor is OFF)

Display	Status
*RUN	Power is supplied to the servomotor.
*BB	Power to the servomotor is OFF.
*PT NT	Forward or reverse run is prohibited.
*P-OT	Forward run is prohibited.
*N-OT	Reverse run is prohibited.
*HBB	In hard-wire base block (safety) state.

Note: The test without a motor status is not displayed during alarm occurs (A.□□□).

5.1 Control Method Selection	5-3
5.2 Basic Functions Settings	5-4
5.2.1 Servo ON Signal	5-4
5.2.2 Servomotor Rotation Direction	5-5
5.2.3 Overtravel	5-6
5.2.4 Holding Brakes	5-9
5.2.5 Stopping Servomotors after /S-ON Turned OFF or Alarm Occurrence	5-14
5.2.6 Instantaneous Power Interruption Settings	5-16
5.2.7 SEMI F47 Function (Torque Limit Function for Low DC Power Supply Voltage for Main Circuit)	5-17
5.2.8 Setting Motor Overload Detection Level	5-20
5.3 Speed Control	5-22
5.3.1 Basic Settings for Speed Control	5-22
5.3.2 Reference Offset Adjustment	5-23
5.3.3 Soft Start	5-26
5.3.4 Speed Reference Filter	5-26
5.3.5 Zero Clamp Function	5-27
5.3.6 Encoder Output Pulses	5-29
5.3.7 Setting Encoder Output Pulse	5-30
5.3.8 Setting Speed Coincidence Signal	5-31
5.4 Position Control	5-32
5.4.1 Basic Settings for Position Control	5-33
5.4.2 Clear Signal Setting	5-37
5.4.3 Reference Pulse Input Multiplication Switching Function	5-38
5.4.4 Electronic Gear	5-39
5.4.5 Smoothing	5-42
5.4.6 Positioning Completed Signal	5-43
5.4.7 Positioning Near Signal	5-44
5.4.8 Reference Pulse Inhibit Function	5-45
5.5 Torque Control	5-46
5.5.1 Basic Settings for Torque Control	5-46
5.5.2 Reference Offset Adjustment	5-47
5.5.3 Torque Reference Filter	5-50
5.5.4 Speed Limit in Torque Control	5-50

5.6	Internal Set Speed Control	5-52
5.6.1	Basic Settings for Speed Control with an Internal Set Speed	5-52
5.6.2	Example of Operating with Internal Set Speeds	5-54
5.7	Combination of Control Methods	5-55
5.7.1	Switching Internal Set Speed Control (Pn000.1 = 4, 5, or 6)	5-55
5.7.2	Switching Other Than Internal Set Speed Control (Pn000.1 = 7, 8 or 9)	5-58
5.7.3	Switching Other Than Internal Set Speed Control (Pn000.1 = A or B)	5-58
5.8	Limiting Torque	5-59
5.8.1	Internal Torque Limit	5-59
5.8.2	External Torque Limit	5-60
5.8.3	Torque Limiting Using an Analog Voltage Reference	5-61
5.8.4	Torque Limiting Using an External Torque Limit and Analog Voltage Reference	5-63
5.8.5	Checking Output Torque Limiting during Operation	5-65
5.9	Absolute Encoders	5-66
5.9.1	Connecting the Absolute Encoder	5-67
5.9.2	Absolute Data Request Signal (SEN)	5-69
5.9.3	Battery Replacement	5-70
5.9.4	Absolute Encoder Setup and Reinitialization	5-73
5.9.5	Absolute Data Reception Sequence	5-74
5.9.6	Multiturn Limit Setting	5-77
5.9.7	Multiturn Limit Disagreement Alarm (A.CC0)	5-78
5.10	Other Output Signals	5-79
5.10.1	Servo Alarm Output Signal (ALM) and Alarm Code Output Signals (ALO1, ALO2, and ALO3)	5-79
5.10.2	Warning Output Signal (/WARN)	5-80
5.10.3	Rotation Detection Output Signal (/TGON)	5-81
5.10.4	Servo Ready Output Signal (/S-RDY)	5-81
5.11	Safety Function	5-82
5.11.1	Hard Wire Base Block (HWBB) Function	5-82
5.11.2	External Device Monitor (EDM1)	5-86
5.11.3	Application Example of Safety Functions	5-88
5.11.4	Confirming Safety Functions	5-89
5.11.5	Precautions for Safety Functions	5-89

5.1 Control Method Selection

The control method supported by the SGD V SERVOPACK are described below.

The control method can be selected with parameter Pn000.

Control Method Selection			
Pn.000.1	Control	Description	Reference Section
n.□□0□ [Factory setting]	Speed Control	Controls servomotor speed by means of an analog voltage speed reference. Use in the following instances. <ul style="list-style-type: none"> To control speed For position control using the encoder pulse output from the SERVOPACK to form a position loop in the host controller. 	5.3 <i>Speed Control</i>
n.□□1□	Position Control	Controls the position of the machine by means of a pulse train position reference. Controls the position with the number of input pulses, and controls the speed with the input pulse frequency. Use when positioning is required.	5.4 <i>Position Control</i>
n.□□2□	Torque Control	Controls the servomotor's output torque by means of an analog voltage torque reference. Use to output the required amount of torque for operations such as stopping on contact.	5.5 <i>Torque Control</i>
n.□□3□	Internal Set Speed Control	Uses the three input signals /P-CON (/SPD-D), /P-CL (/SPD-A), and /N-CL (/SPD-B) to control the speed as set in advance in the SERVOPACK. Three operating speeds can be set in the SERVOPACK. When selecting this control, an analog reference is not necessary.	5.6 <i>Internal Set Speed Control</i>
n.□□4□	Internal Set Speed Control ↔ Speed Control	These are switching modes for using the four control methods given above in combination. Select the control switching method that best suits the application.	5.7 <i>Combination of Control Methods</i>
n.□□5□	Internal Set Speed Control ↔ Position Control		
n.□□6□	Internal Set Speed Control ↔ Torque Control		
n.□□7□	Position Control ↔ Speed Control		
n.□□8□	Position Control ↔ Torque Control		
n.□□9□	Torque Control ↔ Speed Control		
n.□□A□	Speed Control ↔ Speed Control with Zero Clamp Function		
n.□□B□	Position Control ↔ Position Control with Reference Pulse Inhibit Function	The reference pulse inhibit function can be used in position control.	5.4.8 <i>Reference Pulse Inhibit Function</i>

5.2 Basic Functions Settings

5.2.1 Servo ON Signal

This sets the servo ON signal (/S-ON) that determines whether the servomotor power is ON or OFF.

(1) Signal Setting

Type	Name	Connector Pin Number	Setting	Meaning
Input	/S-ON	CN1-40 [Factory setting]	ON	Servomotor power is ON. Servomotor can be operated.
			OFF	Servomotor power is OFF. Servomotor cannot be operated.

Note: Use parameter Pn50A.1 to allocate the /S-ON signal to another terminal. For details, refer to 3.3.1 *Input Signal Allocations* for details.

 IMPORTANT	<p>Always input the servo ON signal before inputting the speed/position/torque reference to start or stop the servomotor. Do not input the references first and then use the servo ON signal or turn ON/OFF the AC power supply to start or stop. Doing so will degrade internal elements and lead to accident. Input the servo ON signal while the servomotor stops. While the servomotor is rotating, the servo ON signal cannot be input.</p>
---	--

(2) Settings for Continuous Servo ON Signal

Parameter Pn50A.1 can be used to enable the Servo ON condition constantly.

Parameter	Meaning	When Enabled	Classification
Pn50A	n.□□0□ [Factory setting]	After restart	Setup
	n.□□7□		

 IMPORTANT	<p>SERVOPACK operation will be possible (i.e., power will be supplied) when the main circuit power supply is turned ON if the servo ON signal is set to be always enabled. When inputting speed/position/torque reference, be sure to implement safety measures for unexpected operation of the servomotor and machine.</p> <p>SERVOPACK operation will be possible (i.e., power will be supplied) when an alarm is reset after an alarm occurs. The servomotor or machine may operate unexpectedly if an alarm is reset while a reference is being input.</p>
---	--

5.2.2 Servomotor Rotation Direction

The servomotor rotation direction can be reversed with parameter Pn000.0 without changing the polarity of the speed/position reference. This causes the rotation direction of the servomotor to change, but the polarity of the signal, such as encoder output pulses, output from the SERVOPACK does not change. (refer to 5.3.6 *Encoder Output Pulses*)

The standard setting for forward rotation is counterclockwise (CCW) as viewed from the load end of the servomotor.

Parameter	Forward/Reverse Reference	Direction of Motor Rotation and Encoder Output Pulse	Applicable Over-travel (OT)
Pn000	n.□□□0 Sets CCW as forward direction. [Factory setting]	<p>Motor speed Torque reference Encoder output pulse PAO PBO Phase B advanced Time Motor speed CCW</p>	P-OT
	Reverse Reference	<p>Motor speed Torque reference Encoder output pulse PAO PBO Phase A advanced Time Motor speed CW</p>	N-OT
	n.□□□1 Sets CW as forward direction. (Reverse Rotation Mode)	<p>Motor speed Torque reference Encoder output pulse PAO PBO Phase B advanced Time Motor speed CW</p>	P-OT
	Reverse Reference	<p>Motor speed Torque reference Encoder output pulse PAO PBO Phase A advanced Time Motor speed CCW</p>	N-OT

Note: SigmaWin+ trace waveforms are shown in the above table.

5.2.3 Overtravel

The overtravel limit function forces movable machine parts to stop if they exceed the allowable range of motion and turn ON a limit switch.

For rotating application such as disc table and conveyor, overtravel function is not necessary. In such a case, no wiring for overtravel input signals is required.

 **CAUTION**

- **Installing limit switches**
 For machines that move using linear motion, connect limit switches to P-OT and N-OT of CN1 as shown below to prevent machine damage. To prevent a contact fault or disconnection from causing accidents, make sure that the limit switches are normally closed.

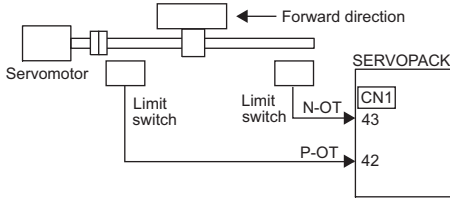

- **Axes to which external force is applied in overtravel**
Vertical axes:
 Occurrence of overtravel may cause a workpiece to fall, because the /BK signal is on, that is when the brake is released. Set the parameter (Pn001 = n.□□1□) to bring the servomotor to zero clamp state after stopping to prevent a workpiece from falling.
Other axes to which external force is applied:
 Overtravel will bring about a baseblock state after the servomotor stops, which may cause the servomotor to be pushed back by the load's external force. To prevent this, set the parameter (Pn001 = n.□□1□) to bring the servomotor to zero clamp state after stopping.
 For details on how to set the parameter, refer to (3) *Servomotor Stopping Method When Overtravel is Used*.

(1) Signal Setting

Type	Name	Connector Pin Number	Setting	Meaning
Input	P-OT	CN1-42	ON	Forward run allowed. Normal operation status.
			OFF	Forward run prohibited. Forward overtravel.
	N-OT	CN1-43	ON	Reverse run allowed. Normal operation status.
			OFF	Reverse run prohibited. Reverse overtravel.

Rotation in the opposite direction is possible during overtravel by inputting the reference.



When the servomotor stops due to overtravel during position control, the position errors are held. A clear signal (CLR) input is required to clear the error pulses.
 For the clear signal, refer to 5.4.2 *Clear Signal Setting*.

IMPORTANT

(2) Overtravel Function Setting

Parameters Pn50A and Pn50B can be set to enable or disable the overtravel function.

If the overtravel function is not used, no wiring for overtravel input signals will be required.

Parameter		Meaning	When Enabled	Classification
Pn50A	n.2□□□ [Factory setting]	Inputs the Forward Run Prohibited (P-OT) signal from CN1-42.	After restart	Setup
	n.8□□□	Disables the Forward Run Prohibited (P-OT) signal. Allows constant forward rotation.		
Pn50B	n.□□□3 [Factory setting]	Inputs the Reverse Run Prohibited (N-OT) signal from CN1-43.		
	n.□□□8	Disables the Reverse Run Prohibited (N-OT) signal. Allows constant reverse rotation.		

A parameter can be used to re-allocate input connector number for the P-OT and N-OT signals. Refer to 3.3.1 *Input Signal Allocations* for details.

(3) Servomotor Stopping Method When Overtravel is Used

There are three servomotor stopping methods when an overtravel is used.

- Dynamic brake
By short-circuiting the electric circuits, the servomotor comes to a quick stop.
- Decelerate to a stop
Stops by using emergency stop torque.
- Coast to a stop
Stops naturally, with no control, by using the friction resistance of the servomotor in operation.

After servomotor stopping, there are two modes.

- Coast mode
Stopped naturally, with no control, by using the friction resistance of the servomotor in operation.
- Zero clamp mode
A mode forms a position loop by using the position reference zero.

The servomotor stopping method when an overtravel (P-OT, N-OT) signal is input while the servomotor is operating can be set with parameter Pn001.

Parameter		Stop Method	Mode After Stopping	When Enabled	Classification
Pn001	n.□□00 [Factory setting]	DB	Coast	After restart	Setup
	n.□□01				
	n.□□02	Coast			
	n.□□1□	Deceleration to a stop	Zero clamp		
	n.□□2□		Coast		

- A servomotor under torque control cannot be decelerated to a stop. The servomotor is stopped with the dynamic braking (DB) or coasts to a stop according to the setting of Pn001.0. After the servomotor stops, the servomotor will enter a coast state.
- For details on servomotor stopping methods after the /S-ON (Servo ON) signal turns OFF or an alarm occurs, refer to 5.2.5 *Stopping Servomotors after /S-ON Turned OFF or Alarm Occurrence*.

■ When Servomotor Stopping Method is Set to Decelerate to Stop

Emergency stop torque can be set with Pn406.

Pn406	Emergency Stop Torque				Classification	
			Speed	Position		Torque
	Setting Range	Setting Unit	Factory Setting	When Enabled		
	0 to 800	1%	800	Immediately		
	Setup					

- The setting unit is a percentage of the rated torque.
- The factory setting is 800% so that the setting is large enough a value to operate the servomotor at maximum torque. The maximum value of emergency stop torque that is actually available, however, is limited to the maximum torque of the servomotor.

(4) Overtravel Warning Function

This function detects an overtravel warning (A.9A0) if overtravel occurs while the servomotor power is ON. Using this function enables notifying the host controller when the SERVOPACK detects overtravel even if the overtravel signal is ON only momentarily.

To use the overtravel warning function, set digit 4 of Pn00D to 1 (detects overtravel warning).

Note: The overtravel warning function is supported by software version 001A or later. The software version can be checked with Fn012. For details, refer to 7.14 Software Version Display (Fn012).

■ Warning Output Timing

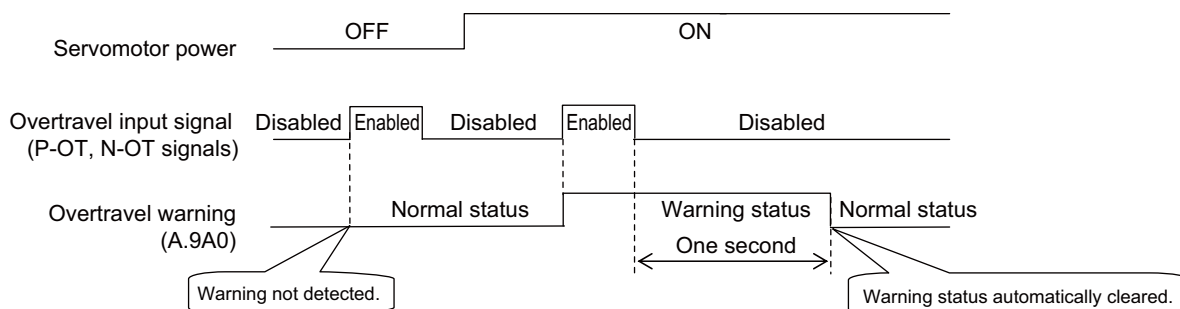

<Notes>

- Warnings are detected for overtravel in the same direction as the reference.
- Warnings are not detected for overtravel in the reverse direction from the reference.
Example: A warning will not be output for a forward reference even if the N-OT signal (reverse run prohibited) turns ON.
- A warning can be detected in either the forward or reverse direction, when there is no reference.
- A warning will not be detected when the servomotor power is OFF even if overtravel occurs.
- A warning will not be detected when the servomotor power changes from OFF to ON even if overtravel status exists.
- The warning output will be held for one second after the overtravel status no longer exists and it will then be cleared automatically.

⚠ CAUTION	
<ul style="list-style-type: none"> • The overtravel warning function only detects warnings. It does not affect on stopping for overtravel or motion operations at the host controller. The next step (e.g., the next motion or other command) can be executed even if an overtravel warning exists. However, depending on the processing specifications and programming for warnings in the host controller, operation may be affected when an overtravel warning occurs (e.g., motion may stop or not stop). Confirm the specifications and programming in the host controller. • When an overtravel occurs, the SERVOPACK will perform stop processing for overtravel. Therefore, when an overtravel warning occurs, the servomotor may not reach the target position specified by the host controller. Check the feedback position to make sure that the axis is stopped at a safe position. 	

■ Related Parameter

Parameter	Meaning	When Enabled	Classification
Pn00D	n.0□□□ [Factory setting]	Immediately	Setup
	n.1□□□		

5.2.4 Holding Brakes

A holding brake is a brake used to hold the position of the movable part of the machine when the SERVOPACK is turned OFF so that movable part does not move due to gravity or external forces. Holding brakes are built into servomotors with brakes.

The holding brake is used in the following cases.

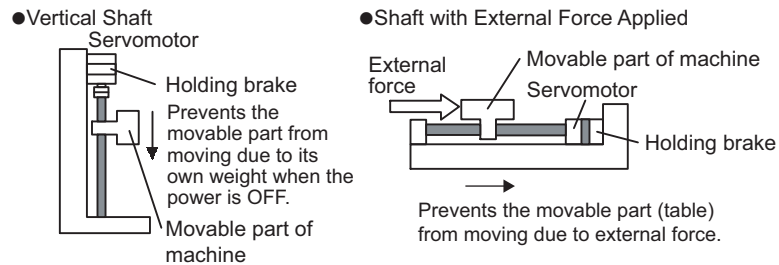

IMPORTANT

- The brake built into the servomotor with brakes is a de-energization brake, which is used only to hold and cannot be used for braking. Use the holding brake only to hold a stopped servomotor.

There is a delay in the braking operation. Set the following ON/OFF timing.

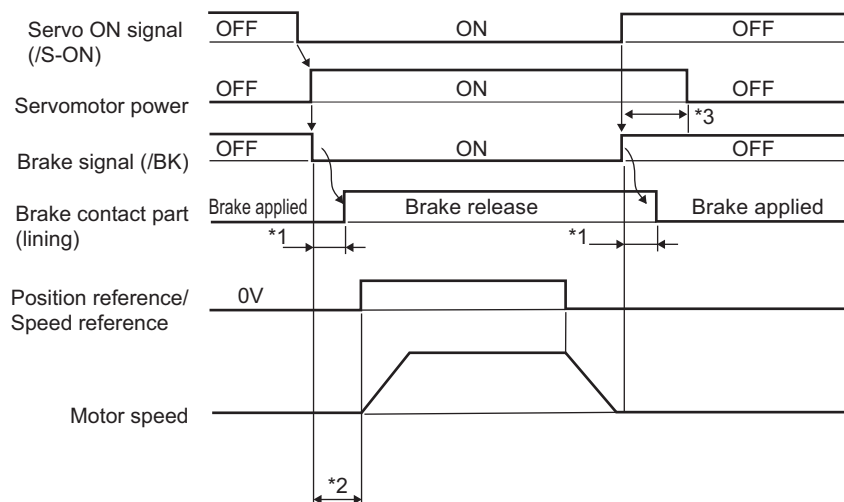

- *1. The operation delay time of the brake depends on the model. For details, refer to *Brake Operation Delay Time* shown below.
- *2. After the /S-ON signal has turned ON and 50 ms has passed since the brake was released, output the reference from the host controller to the SERVOPACK.
- *3. Use Pn506, Pn507, and Pn508 to set the timing of when the brake will be activated and when the servomotor power will be turned OFF.

Brake Operation Delay Time

Model	Voltage	Brake Release Time (ms)	Brake Applied Time (ms)
SGMJV-A5 to 04	24 VDC	60	100
SGMJV-08		80	100
SGMAV-A5 to 04		60	100
SGMAV-06 to 10		80	100
SGMPS-01, -08		20	100
SGMPS-02, -04, -15		40	100
SGMGV-03 to 20	24 VDC, 90 VDC	100	80
SGMGV-30, -44		170	100 (24 VDC), 80 (90 VDC)
SGMGV-55, -75, -1A		170	80
SGMGV-1E		250	80
SGMSV-10 to 25		170	80
SGMSV-30 to 50		100	80

Note: The above operation delay time is an example when the power supply is turned ON and OFF on the DC side.
Be sure to evaluate the above times on the actual equipment before using the application.

(1) Wiring Example

Use the brake signal (/BK) and the brake power supply to form a brake ON/OFF circuit. The following diagram shows a standard wiring example.

The timing can be easily set using the brake signal (/BK).

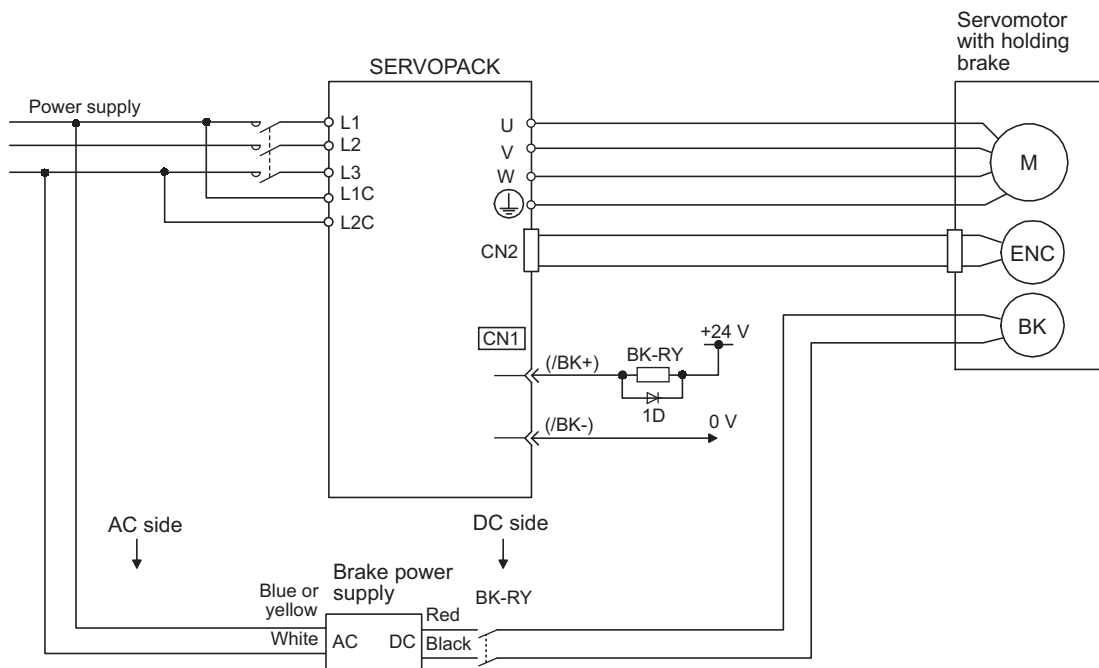

BK-RY: Brake control relay
 Brake power supply for 90 V Input voltage 200-V models: LPSE-2H01-E
 Input voltage 100-V models: LPDE-1H01-E
 A 24 VDC power supply is not included.

!
IMPORTANT

- Select the optimum surge absorber in accordance with the applied brake current and brake power supply.
When using the LPSE-2H01-E power supply: Z10D471 (Made by SEMITEC Corporation)
When using the LPDE-1H01-E power supply: Z10D271 (Made by SEMITEC Corporation)
When using the 24-V power supply: Z15D121 (Made by SEMITEC Corporation)
- After the surge absorber is connected, check the total time the brake is applied for the system. Depending on the surge absorber, the total time the brake is applied can be changed.
- Configure the relay circuit to apply the holding brake by the emergency stop.

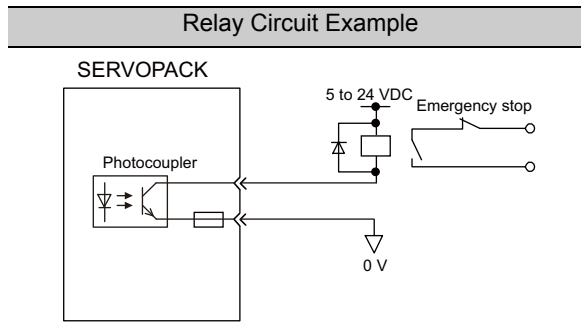

- The brake signal (/BK) cannot be used with factory settings. The output signal must be allocated. Refer to (3) *Brake Signal (/BK) Allocation* to set the parameter Pn50F.
- When using a 24-V brake, separate the 24-VDC power supply from other power supplies, such as the one used for the I/O signals of CN1 connectors. Always install the 24-VDC power supply separately. If the power supply is shared, the I/O signals might malfunction.

(2) Brake Signal (/BK) Setting

This output signal controls the brake. The output signal must be allocated with Pn50F. Refer to (3) *Brake Signal (/BK) Allocation* for allocation.

The /BK signal turns OFF (applies the brake) when an alarm is detected or the /S-ON signal is turned OFF. The brake OFF timing can be adjusted with Pn506.

Type	Name	Connector Pin Number	Setting	Meaning
Output	/BK	Must be allocated	ON (closed)	Releases the brake.
			OFF (open)	Applies the brake.

!
IMPORTANT

The /BK signal is still ON during overtravel and the brake is still released.

(3) Brake Signal (/BK) Allocation

The brake signal (/BK) is not allocated at shipment. Use parameter Pn50F.2 to allocate the /BK signal.

Parameter	Connector Pin Number		Meaning	When Enabled	Classification
	+ Terminal	- Terminal			
Pn50F	n.□0□□ [Factory setting]	–	–	The /BK signal is not used.	After restart Setup
	n.□1□□	CN1-25	CN1-26	The /BK signal is output from output terminal CN1-25, 26.	
	n.□2□□	CN1-27	CN1-28	The /BK signal is output from output terminal CN1-27, 28.	
	n.□3□□	CN1-29	CN1-30	The /BK signal is output from output terminal CN1-29, 30.	



IMPORTANT When multiple signals are allocated to the same output terminal, the signals are output with OR logic. For the /BK signal, do not use the output terminal that is already being used for another signal.

(4) Brake ON Timing after the Servomotor Stops

When the servomotor stops, the /BK signal turns OFF at the same time as the /S-ON signal is turned OFF. Use parameter Pn506 to change the timing to turn OFF the servomotor power after the /S-ON signal has turned OFF.

Pn506	Brake Reference-Servo OFF Delay Time				Classification	
			<input type="checkbox"/> Speed	<input type="checkbox"/> Position		<input type="checkbox"/> Torque
	Setting Range	Setting Unit	Factory Setting	When Enabled		
	0 to 50	10 ms	0	Immediately	Setup	

- When using the servomotor to control a vertical axis, the machine movable part may shift slightly depending on the brake ON timing due to gravity or an external force. To eliminate this slight shift, set parameter so that the power to the servomotor turns OFF after the brake is applied.
- This parameter changes the brake ON timing while the servomotor is stopped.

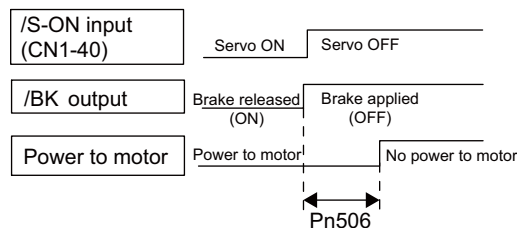



IMPORTANT The servomotor will turn OFF immediately when an alarm occurs, regardless of the setting of this parameter. The machine movable part may shift due to gravity or external force before the brake operates.

(5) Brake Signal (/BK) Output Timing during Servomotor Rotation

If an alarm occurs while the servomotor is rotating, the servomotor will come to a stop and the brake signal (/BK) will be turned OFF. The timing of brake signal (/BK) output can be adjusted by setting the brake reference output speed level (Pn507) and the waiting time for brake signal when motor running (Pn508).

Note: If the servomotor is set so that it comes to a zero-speed stop for an alarm, follow the information in (4) *Brake ON Timing after the Servomotor Stops* after the servomotor comes to a stop for a zero position reference.

Pn507	Brake Reference Output Speed Level Speed Position Torque				Classification
	Setting Range	Setting Unit	Factory Setting	When Enabled	
	0 to 10000	1 min ⁻¹	100	Immediately	Setup
Pn508	Waiting Time for Brake Signal When Motor Running Speed Position Torque				Classification
	Setting Range	Setting Unit	Factory Setting	When Enabled	
	10 to 100	10 ms	50	Immediately	Setup

/BK Signal Output Conditions When Servomotor Rotating

The /BK signal goes to high level (brake ON) when either of the following conditions is satisfied:

- When the motor speed falls below the level set in Pn507 after the power to the servomotor is turned OFF.
- When the time set in Pn508 is exceeded after the power to the servomotor is turned OFF.

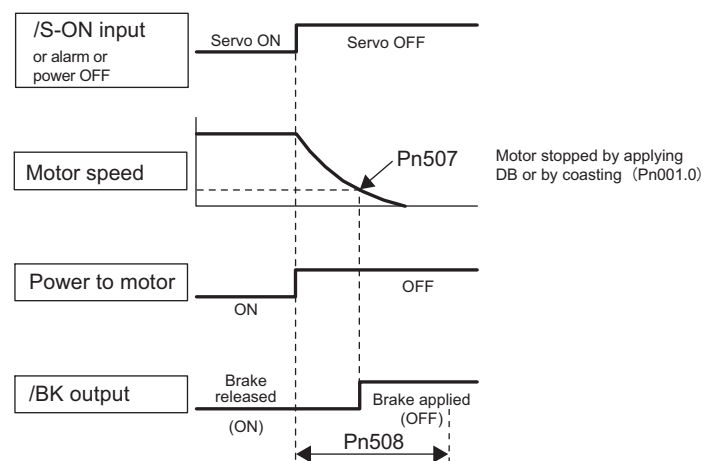

IMPORTANT

- The servomotor will be limited to its maximum speed even if the value set in Pn507 is higher than the maximum speed.
- Do not allocate the rotation detection signal (/TGON) and the brake signal (/BK) to the same terminal. The /TGON signal will otherwise be turned ON by the falling speed on a vertical axis, and the brake may not operate. For the /BK signal, do not use the terminal that is already being used for another signal.

5.2.5 Stopping Servomotors after /S-ON Turned OFF or Alarm Occurrence

The servomotor stopping method can be selected after the /S-ON (Servo ON) signal turns OFF or an alarm occurs.



IMPORTANT

- Dynamic braking (DB) is used for emergency stops. The DB circuit will operate frequently if the power is turned ON and OFF or the /S-ON signal is ON and OFF with a reference input applied to start and stop the servomotor, which may result in deterioration of the internal elements in the SERVOPACK.
Use speed input references or position references to start and stop the servomotor.
- If the main circuit power supply or the control power supply is turned OFF but the /S-ON signal is not OFF, the stopping method for servomotor cannot be set in the parameters. Use the following method to stop the servomotor.
If turning OFF the main circuit power supply, but the /S-ON signal is not OFF, the servomotor will be stopped by dynamic braking.
If turning OFF the control power supply, but the /S-ON signal is not OFF, the stopping method will vary with the SERVOPACK model. Two stopping methods are available.
 - SERVOPACK models for servomotors that stop by coasting:
SGDV-330A, -470A, -550A, -590A, -780A, -280D, -370D
 - SERVOPACK models for servomotors that stops by dynamic braking:
All SERVOPACKs other than those listed for coasting.
- If the servomotor must be stopped by coasting rather than by dynamic braking when the main circuit power supply or the control power supply is turned OFF but the /S-ON signal is not OFF, arrange the sequence externally so the current will be cut off for servomotor wires U, V, and W.
- To minimize the coasting distance of the servomotor to come to a stop when an alarm occurs, the zero-speed stopping method is factory-set for alarms to which the zero-speed stop method is applicable. The DB stopping method may be more suitable than the zero-speed stopping method, however, depending on the application.
For example, for multiple axes coupling operation (a twin-drive operation), machinery damage may result if a zero-speed stop alarm occurs for one of the coupled shafts and the other shaft stops by dynamic brake. In such cases, change the method to the DB stopping method.

(1) Stopping Method for Servomotor after /S-ON Signal is Turned OFF

Use Pn001.0 to select the stopping method for the servomotor after the /S-ON signal is OFF.

	Parameter	Stop Mode	Mode After Stopping	When Enabled	Classification
Pn001	n.□□□0 [Factory setting]	DB	DB	After restart	Setup
	n.□□□1		Coast		
	n.□□□2	Coast	Coast		

Note: Similar to the Coast Mode, the n.□□□0 setting (which stops the servomotor by dynamic braking and then holds it in Dynamic Brake Mode) does not generate any braking force when the servomotor stops or when it rotates at very low speed.

(2) Stopping Method for Servomotor When an Alarm Occurs

There are two types of alarms (Gr.1 and Gr.2) that depend on the stopping method when an alarm occurs. Select the stopping method for the servomotor when an alarm occurs using Pn001.0 and Pn00B.1.

The stopping method for the servomotor for a Gr.1 alarm is set to Pn001.0.

The stopping method for the servomotor for a Gr.2 alarm is set to Pn00B.1.

Refer to the information on alarm stopping methods in *10.1.1 List of Alarms*.

■ Stopping Method for Servomotor for Gr.1 Alarms

The stopping method of the servomotor when a Gr.1 alarm occurs is the same as that in (1) *Stopping Method for Servomotor after /S-ON Signal is Turned OFF*.

Parameter		Stop Mode	Mode After Stopping	When Enabled	Classification
Pn001	n.□□□0 [Factory setting]	DB	DB	After restart	Setup
	n.□□□1		Coast		
	n.□□□2	Coast	Coast		

■ Stopping Method for Servomotor for Gr.2 Alarms

Parameter		Stop Mode	Mode After Stopping	When Enabled	Classification
Pn00B	Pn001				
n.□□0□ [Factory setting]	n.□□□0 [Factory setting]	Zero-speed stopping*	DB	After restart	Setup
	n.□□□1		Coast		
	n.□□□2				
n.□□1□	n.□□□0 [Factory setting]	DB	DB	After restart	Setup
	n.□□□1		Coast		
	n.□□□2	Coast			

* Zero-speed stopping: The speed reference is set to 0 to stop quickly.

Note: The setting of Pn00B.1 is effective for position control and speed control. Pn00B.1 will be ignored for torque control and only the setting of Pn001.0 will be valid.

5.2.6 Instantaneous Power Interruption Settings

Determines whether to continue operation or turn OFF the servomotor's power when the power supply voltage to the SERVOPACK's main circuit is interrupted.

Pn509	Instantaneous Power Cut Hold Time				Classification
	Setting Range	Setting Unit	Factory Setting	When Enabled	
	20 to 1000	1 ms	20	Immediately	

If the power interruption time is shorter than the set value in Pn509, the servomotor will continue operation. If it is longer than the set value, the servomotor's power will be turned OFF during the power interruption. The servomotor is turned ON when power supply to the main circuit recovers.

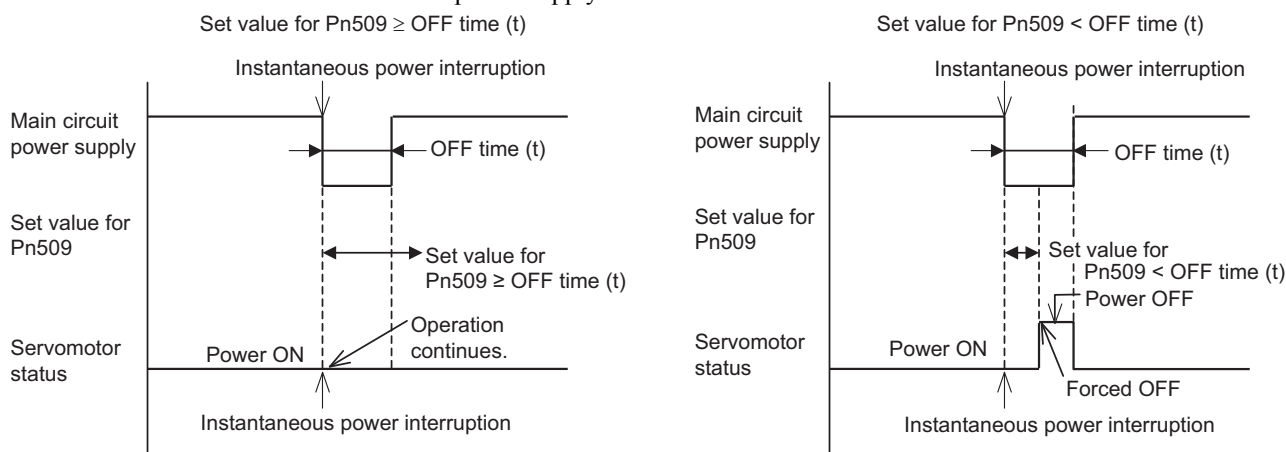

Note: If the instantaneous power interruption is longer than the set value of Pn509, the /S-RDY signal turns OFF.



- The holding time of the control power supply for the 200-V SERVOPACKs is approximately 100 ms. The holding time of the control power supply for the 100-V SERVOPACKs is approximately 65 ms. If the control power supply makes control impossible during an instantaneous power interruption, the same operation will be performed as for normally turning OFF the power supply, and the setting of Pn509 will be ignored.
- The holding time of the main circuit power supply varies with the output of the SERVOPACK. If the load on the servomotor is large and an undervoltage alarm (A.410) occurs, the setting of Pn509 will be ignored.
- The holding time of the control power supply (24 VDC) for the 400-V SERVOPACKs depends on the capability of the power supply (not included). Check the power supply before using the application.

If the uninterruptible power supplies are used for the control power supply and main circuit power supply, the SERVOPACK can withstand an instantaneous power interruption period in excess of 1000 ms.

5.2.7 SEMI F47 Function (Torque Limit Function for Low DC Power Supply Voltage for Main Circuit)

The torque limit function detects an undervoltage warning and limits the output current if the DC power supply voltage for the main circuit in the SERVOPACK drops to a specified value because the power was momentarily interrupted or the power supply voltage for the main circuit was temporarily lowered.

This function complies with SEMI F47 standards for semiconductor production equipment.

Combining this function with the parameter for Instantaneous Power Cut Hold Time allows the servomotor to continue operating without stopping for an alarm or without recovery work even if the power supply voltage drops.



IMPORTANT

- This function is able to cope with instantaneous power interruptions in the voltage and time ranges stipulated in SEMI F47. An uninterruptible power supply (UPS) is required as a backup for instantaneous power interruptions that exceed these voltage and time ranges.
- This function is intended for voltage drops in the main circuit power supply. The following restrictions apply when it is used to provide an instantaneous power cut hold time in the control power supply. (There are no restrictions for the 200-VAC SERVOPACKs.)

<Control Power Supply Restrictions>

SERVOPACK with 400-VAC Power Input: Provide the control power supply from a 24-VDC power supply that complies with SEMI F47 standards.

SERVOPACK with 100-VAC Power Input: Provide the control power supply from an uninterruptible power supply (UPS).

- Set the host controller and SERVOPACK torque limit so that a torque reference that exceeds the specified acceleration will not be output when the power supply for the main circuit is restored.
- Do not limit the torque to values lower than the holding torque for the vertical axis.
- This function limits torque within the range of the SERVOPACK's capability when the power is cut. It is not intended for use under all load and operating conditions. Use the actual machine to set parameters while confirming correct operation.
- Setting the Instantaneous Power Cut Hold Time lengthens the amount of time from when the power supply is turned OFF until the motor current turns OFF. Turn the servo ON signal ON and OFF to instantly stop the motor current.

(1) Execution Method

This function can be executed either with the host controller and the SERVOPACK or with the SERVOPACK only.

■ With the Host Controller and the SERVOPACK

The host controller limits the torque in response to an undervoltage warning.
The host controller removes the torque limit after the undervoltage warning is cleared.

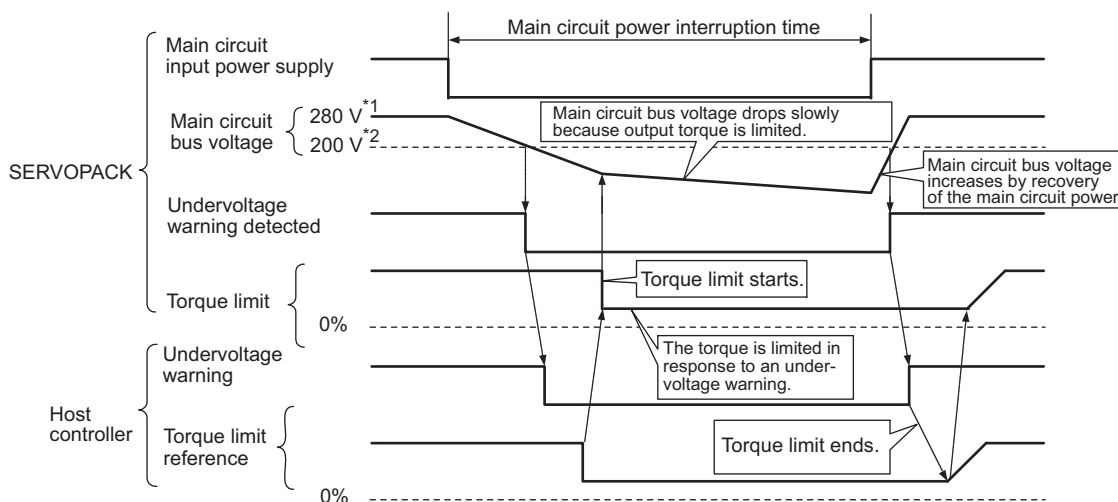

*1. 560 V for 400-V power supply.
*2. 400 V for 400-V power supply.

■ With the SERVOPACK only

The torque is limited in the SERVOPACK in response to an undervoltage warning.
The SERVOPACK controls the torque limit value in the set time after the undervoltage warning is cleared.
Use Pn008.1 to specify whether the function is executed by the host controller and SERVOPACK or by the SERVOPACK only.

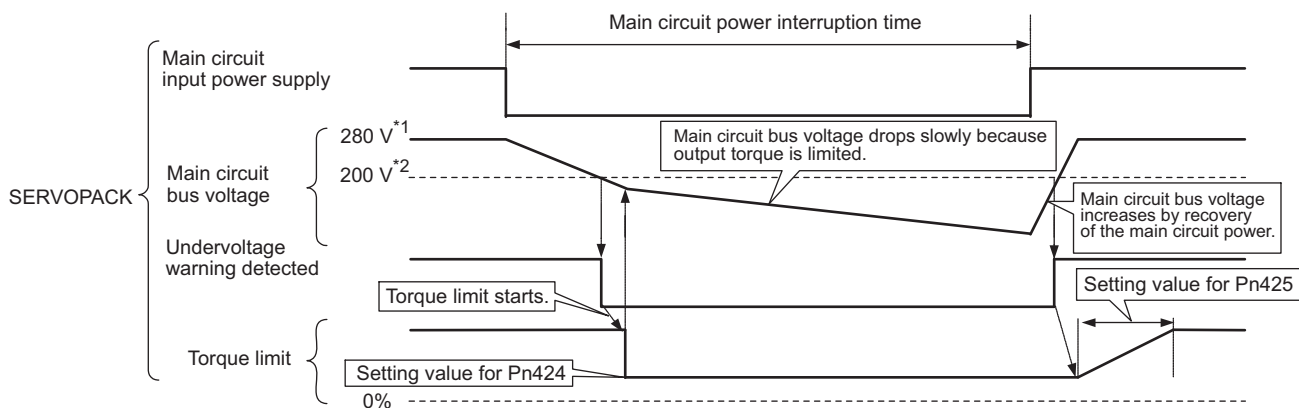

*1. 560 V for 400-V power supply.
*2. 400 V for 400-V power supply.

(2) Related Parameters

Parameter	Meaning	When Enabled	Classification
Pn008	n.□□0□ [Factory setting]	Does not detect undervoltage.	After restart Setup
	n.□□1□	Detects warning and limits torque by host controller.	
	n.□□2□	Detects warning and limits torque by Pn424 and Pn425. (Only in the SERVOPACK)	

Pn424	Torque Limit at Main Circuit Voltage Drop [Speed] [Position] [Torque]				Classification
	Setting Range	Setting Unit	Factory Setting	When Enabled	
	0 to 100	1%*	50	Immediately	Setup
Pn425	Release Time for Torque Limit at Main Circuit Voltage Drop [Speed] [Position] [Torque]				Classification
	Setting Range	Setting Unit	Factory Setting	When Enabled	
	0 to 1000	1 ms	100	Immediately	Setup

* The setting unit is a percentage of the rated torque.

Pn509	Instantaneous Power Cut Hold Time [Speed] [Position] [Torque]				Classification
	Setting Range	Setting Unit	Factory Setting	When Enabled	
	20 to 1000	1 ms	20	Immediately	Setup

Note: When using SEMI F47 function, set 1000 ms.

5.2.8 Setting Motor Overload Detection Level

In this SERVOPACK, the detection timing of the warnings and alarms can be changed by changing how to detect an overload warning (A.910) and overload (low load) alarm (A.720).

The overload characteristics and the detection level of the overload (high load) alarm (A.710) cannot be changed.

(1) Changing Detection Timing of Overload Warning (A.910)

The overload warning level is set by default to 20% so that an overload warning is detected in 20% of the time required to detect an overload alarm. The time required to detect an overload warning can be changed by changing the setting of the overload warning level (Pn52B). This protective function enables the warning output signal (/WARN) to serve as a protective function and to be output at the best timing for your system.

The following graph shows an example of the detection of an overload warning when the overload warning level (Pn52B) is changed from 20% to 50%. An overload warning is detected in half of the time required to detect an overload alarm.

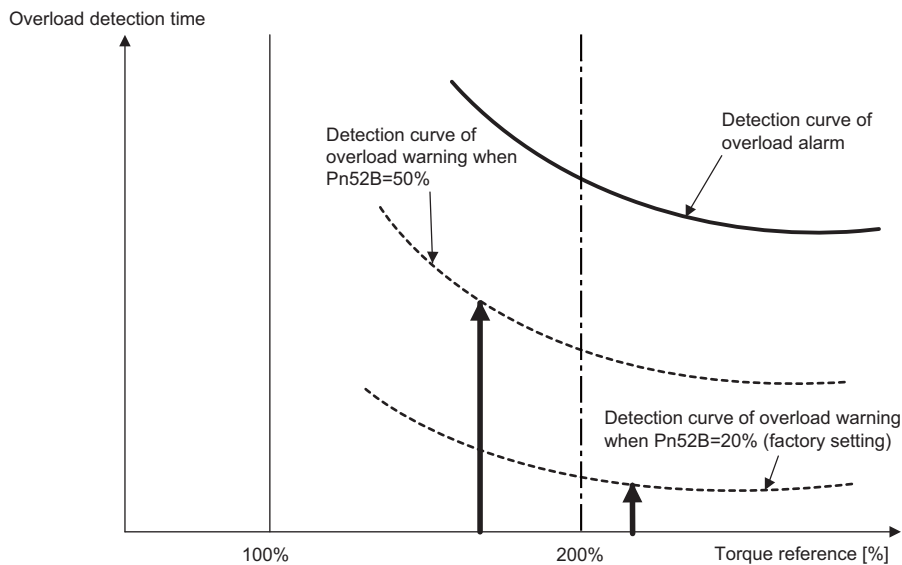

Note: For details, refer to *Overload Characteristics* listed in the section for the relevant servomotor in the *Σ-V Series Product Catalog* (No.: KAEP S800000 42).

Pn52B	Overload Warning Level				Classification
	Setting Range	Setting Unit	Speed	Position	
			Factory Setting	When Enabled	
	1 to 100	1%	20	Immediately	Setup

(2) Changing Detection Timing of Overload (Low Load) Alarm (A.720)

An overload (low load) alarm (A.720) can be detected earlier to protect the servomotor from overloading. The time required to detect an overload alarm can be shortened by using the derated motor base current obtained with the following equation.

Note: The detection level of the overload (high load) alarm (A.710) cannot be changed.

Motor base current × Derating of base current at detecting overload of motor (Pn52C)
= Derated motor base current

Motor base current: Threshold value of motor current to start calculation for overload alarm
Derating of base current at detecting overload of motor (Pn52C): Derating of motor base current

The following graph shows an example of the detection of an overload alarm when Pn52C is set to 50%. The calculation for the overload of motors starts at 50% of the motor base current and then an overload alarm will be detected earlier.

Changing the setting of Pn52C will change the detection timing of the overload alarm, so the time required to detect the overload warning will also be changed.

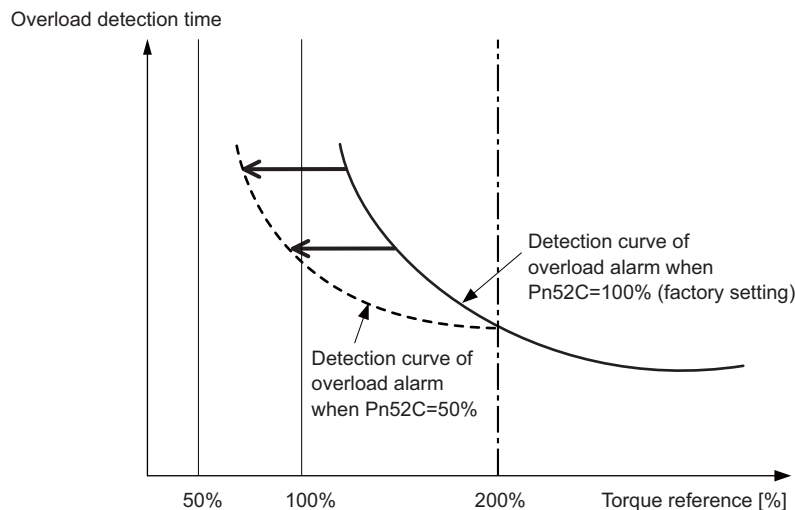

As a guideline of motor heating conditions, the relationship between the heat sink sizes and deratings of base current is shown in a graph in:

Servomotor Heating Conditions in *Rotary Servomotors General Instruction* in Σ -V Series Product Catalog (No.: KAEP S800000 42).

Set Pn52C to a value in accordance with the heat sink size and derating shown in the graph, so that an overload alarm can be detected at the best timing to protect the servomotor from overloading.

Note: For details, refer to *Overload Characteristics* listed in the section for the relevant servomotor in the Σ -V Series Product Catalog (No.: KAEP S800000 42).

Pn52C	Derating of Base Current at Detecting Overload of Motor				Classification
	Setting Range	Setting Unit	Factory Setting	When Enabled	
	10 to 100	1%	100	After restart	Setup

5.3 Speed Control

This section describes operation with speed control.

Select the speed control with parameter Pn000.1.

Parameter	Meaning	When Enabled	Classification
Pn000	n.□□0□ [Factory setting]	Speed control	After restart
			Setup

5.3.1 Basic Settings for Speed Control

This section describes the basic settings for speed control.

(1) Signal Setting

Input the speed reference to the SERVOPACK using the analog voltage reference to control the servomotor speed in proportion to the input voltage.

Type	Signal Name	Connector Pin Number	Name
Input	V-REF	CN1-5	Speed reference input
	SG	CN1-6	Signal ground for speed reference input

Maximum input voltage: ± 12 VDC

■ Input Circuit Example

Example:

Motor rated speed with Pn300 = 006.00: 6.00 V [Factory setting]

Note: The setting value is 600, but it will be displayed on the operator as 006.00.

Speed Reference Input	Rotation Direction	Motor Speed	SGMJV Servomotor
+6 V	Forward	Rated motor speed	3000 min ⁻¹
-3 V	Reverse	1/2 rated motor speed	-1500 min ⁻¹
+1 V	Forward	1/6 rated motor speed	500 min ⁻¹

Connect the pins for the V-REF signal and SG to the speed reference output terminal on the host controller when using a host controller, such as a programmable controller, for position control.

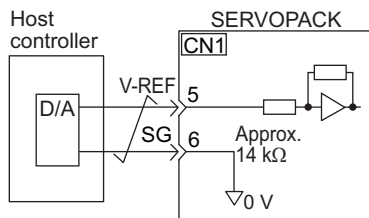

Note: Always use twisted-pair cable to control noise.

(2) Parameter Setting

Using Pn300, set the analog voltage level for the speed reference (V-REF) necessary to operate the servomotor at the rated speed.

Pn300	Speed Reference Input Gain				Classification
			Speed	Position	
	Setting Range	Setting Unit	Factory Setting	When Enabled	
	150 to 3000	0.01 V/rated speed	600 (Rated speed at 6.00 V)	Immediately	Setup

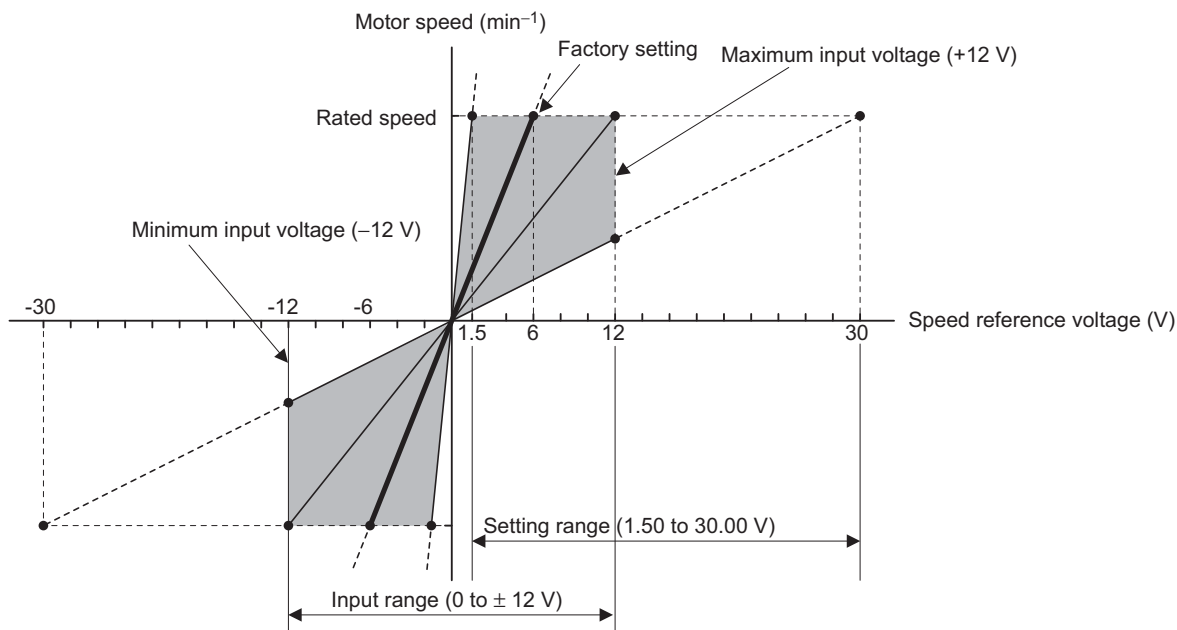

5.3.2 Reference Offset Adjustment

In speed control, the servomotor may rotate at a very low speed with a voltage reference of 0 V. This occurs because the internal reference voltage of the SERVOPACK has a slight offset of a few millivolts. It is called "offset".

If the servomotor rotates at a very low speed, the offset needs to be eliminated using the offset adjustment function.

Use either automatic adjustment or manual adjustment. Automatic adjustment uses the automatic adjustment parameter for reference offset (Fn009). Manual adjustment uses the manual adjustment parameter for reference offset (Fn00A).

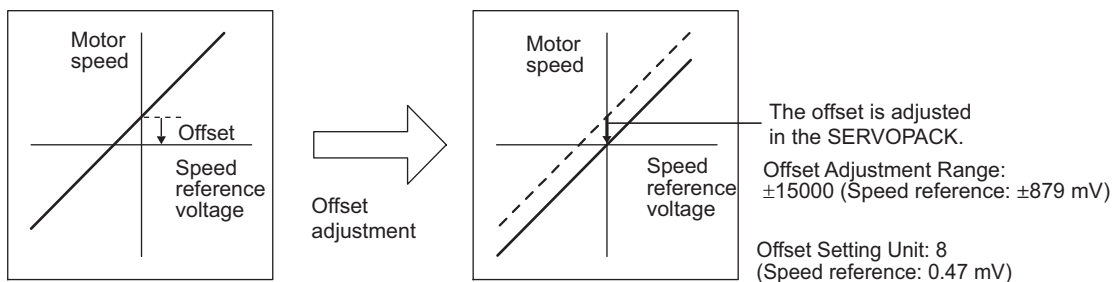

(1) Automatic Adjustment of Reference Offset (Fn009)

The automatic adjustment of reference offset measures the amount of offset and adjusts the reference voltage automatically. After completion of the automatic adjustment, the amount of offset measured is saved in the SERVOPACK.



The servomotor power must be OFF when automatically adjusting the reference offset.

IMPORTANT

Note: The adjusted value is not initialized by executing the Fn005 function (Initializing Parameter Settings).







■ Preparation

The following conditions must be met to adjust the offsets of speed reference automatically. The message “NO-OP” indicating that the settings are not appropriate will be displayed, if the following conditions are not met.

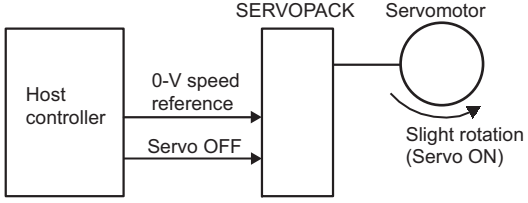
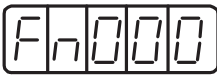
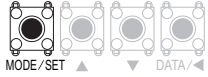
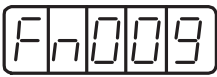
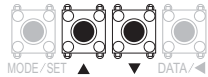
- The write prohibited setting parameter (Fn010) must be set to Write permitted (P.0000).
- The servomotor power must be OFF.

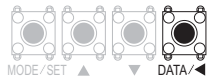
■ Operating Procedure

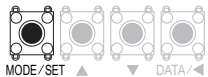
Adjust the reference offset automatically with the panel operator using the following steps.

Step	Display after Operation	Keys	Operation
1			Turn OFF the servo ON signal (/S-ON), and input the 0-V reference voltage from the host controller or external circuit. <div style="text-align: center; margin-top: 10px;">  </div>
2			Press the MODE/SET Key to select the utility function.
3			Press the UP or the DOWN Key to select Fn009.
4			Press the DATA/SHIFT Key for approximately one second. "rEF_o" is displayed.
5			Press the MODE/SET Key. After "donE" flashes for approximately one second, "rEF_o" is displayed again.
6			Press the DATA/SHIFT Key for approximately one second. "Fn009" is displayed again.

Note: The automatic adjustment of reference offset (Fn009) cannot be used when a position loop has been formed with a host controller. Use the manual adjustment of reference offset described in (2) *Manual Adjustment of Reference Offset (Fn00A)*.

(2) Manual Adjustment of Reference Offset (Fn00A)

This method adjusts the offset inputting the amount of reference offset directly.

Use the manual adjustment of the reference offset (Fn00A) in the following cases:

- To adjust the position error to zero when a position loop is formed with the host controller and the servomotor is stopped by servolock.
- To deliberately set the offset amount to some value.
- To check the offset amount set in the automatic adjustment mode of reference offset.

Note: The adjusted value is not initialized by executing the Fn005 function (Initializing Parameter Settings).

■ Preparation

The following conditions must be met to adjust the offsets of speed reference manually.

- The write prohibited setting parameter (Fn010) must be set to Write permitted (P.0000).
- The main circuit power supply must be ON. (Refer to 5.10.4.)

■ Operating Procedure

Adjust the reference offset manually with the panel operator using the following steps.

Step	Display after Operation	Keys	Operation
1			Press the MODE/SET Key to select the utility function.
2			Press the UP or the DOWN Key to select Fn00A.
3			Press the DATA/SHIFT Key for approximately one second. The display shown on the left appears. Note: When "no_oP" flashes for approximately one second, the write prohibited setting has been set in Fn010. Change the setting in Fn010 and press the key again to enable writing. (Refer to 7.12.)
4			Turn ON the servo ON signal (/S-ON) from an external device. The display shown on the left appears.
5			Press the DATA/SHIFT Key for approximately one second. The present offset amount is displayed.
6			Press the UP or the DOWN Key to stop the motor. The displayed value is the amount of the offset after adjustment.
7			Press the MODE/SET Key. After "donE" flashes for approximately one second, the display shown on the left appears.
8			Press the DATA/SHIFT Key for approximately one second. "Fn00A" is displayed again.

5.3.3 Soft Start

The soft start is a function to convert stepped speed reference input into constant acceleration and deceleration. The time can be set for acceleration and deceleration.

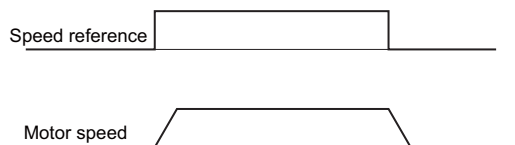

Use this function to smooth speed control (including selection of internal set speeds).

Note: Set both parameters Pn305 and Pn306 to "0" (factory setting) for normal speed control.

Pn305	Soft Start Acceleration Time Speed				Classification
	Setting Range	Setting Unit	Factory Setting	When Enabled	
	0 to 10000	1 ms	0	Immediately	Setup
Pn306	Soft Start Deceleration Time Speed				Classification
	Setting Range	Setting Unit	Factory Setting	When Enabled	
	0 to 10000	1 ms	0	Immediately	Setup

Pn305: The time interval from the time the servomotor starts until the motor maximum speed is reached.

Pn306: The time interval from the time the servomotor is operating at the motor maximum speed until it stops.

Actual accel/decel time can be calculated with the following equation.

- Actual accel time = $\frac{\text{Target speed}}{\text{Max. speed}} \times \text{Soft start time (accel time Pn305)}$
- Actual decel time = $\frac{\text{Target speed}}{\text{Max. speed}} \times \text{Soft start time (decel time Pn306)}$

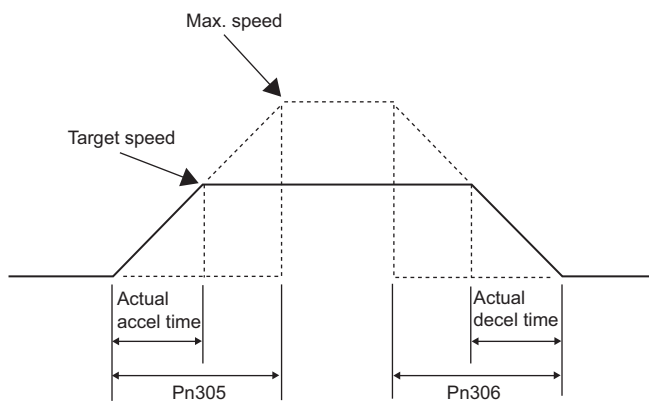

5.3.4 Speed Reference Filter

This smooths the speed reference by applying a first order lag filter to the analog speed reference (V-REF) input.

Note: The user need not usually change the setting. A setting value that is too large, however, will slow down response. Check the response characteristics when setting this parameter.

Pn307	Speed Reference Filter Time Constant Speed Position Torque				Classification
	Setting Range	Setting Unit	Factory Setting	When Enabled	
	0 to 65535	0.01 ms	40	Immediately	Setup

5.3.5 Zero Clamp Function

The zero clamp function locks the servo when the input voltage of the speed reference (V-REF) drops below the speed set in the zero clamp level (Pn501) while the zero clamp signal (/P-CON or /ZCLAMP) is ON. The SERVOPACK internally forms a position loop, ignoring the speed reference.

The zero clamp function is used for systems in which the host controller does not form a position loop for the speed reference input.

The servomotor is clamped within one pulse of the position when the zero clamp function is turned ON, and will still return to the zero clamp position even if it is forcibly rotated by external force.

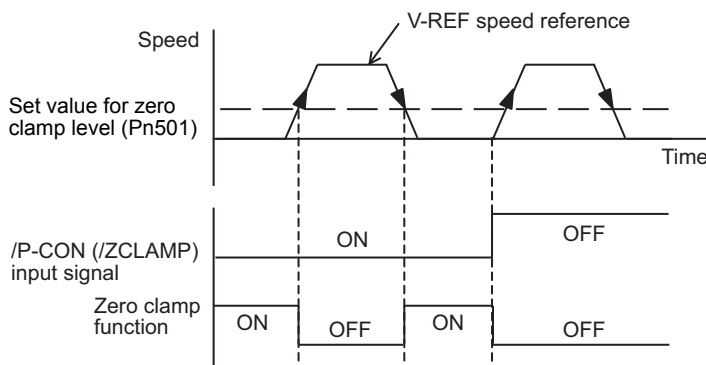
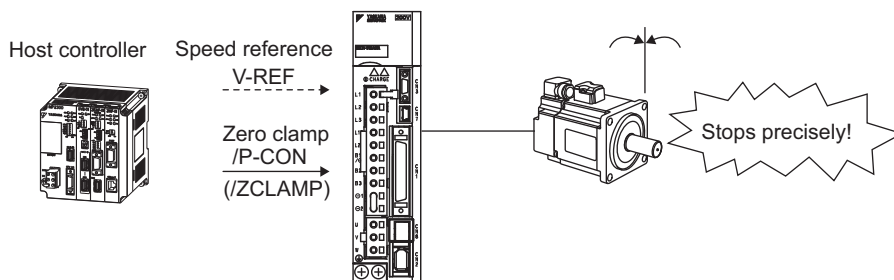

Adjust the position loop gain (Pn102) if the servomotor oscillates in the zero clamp state. If the gain switching function is used, adjusting the 2nd position loop gain (Pn106) is required as well. For details, refer to 6.8.1 *Switching Gain Settings*.

(1) Factory-set Input Signal Allocations (Pn50A.0 = 0)

When Pn000.1 is set to A, the control method becomes "speed control <=> speed control with zero clamp function" and the /P-CON signal is used as a zero clamp signal.

Type	Connector Pin Number	Setting	Meaning
Input	/P-CON CN1-41 [Factory setting]	ON (closed)	The zero clamp function will be turned ON if the input voltage of the speed reference (V-REF) drops below the set speed in the zero clamp level (Pn501).
		OFF (open)	Turns OFF the zero clamp function.

Parameter	Control Method	When Enabled	Classification
Pn000	n.□□□□ Speed control <=> speed control with zero clamp function	After restart	Setup

(2) Changing Input Signal Allocations (Pn50A.0 = 1)

Use the /ZCLAMP signal when switching to zero clamp function.

Type	Connector Pin Number	Setting	Meaning	
Input	/ZCLAMP	Must be allocated	ON (closed)	The zero clamp function will be turned ON if the input voltage of the speed reference (V-REF) drops below the set speed in the zero clamp level (Pn501).
			OFF (open)	Turns OFF the zero clamp function.

Note: Use parameter Pn50D.0 to allocate the /ZCLAMP signal for use. For details, refer to 3.3.1 *Input Signal Allocations*.

To use the zero clamp function, set Pn000.1 to 0, 3, 4, 5, 6, 7, 9 or A.

Parameter	Control Method	Input Signal Used	When Enabled	Classification	
Pn000	n.□□0□	Speed control	/ZCLAMP	After restart	Setup
	n.□□3□	Internal set speed control	/ZCLAMP, SPD-A, SPD-B, SPD-D, C-SEL		
	n.□□4□	Internal set speed control <=> Speed control	/ZCLAMP, SPD-A, SPD-B, SPD-D, C-SEL		
	n.□□5□	Internal set speed control <=> Position control	/ZCLAMP, SPD-A, SPD-B, SPD-D, C-SEL		
	n.□□6□	Internal set speed control <=> Torque control	/ZCLAMP, SPD-A, SPD-B, SPD-D, C-SEL		
	n.□□7□	Position control <=> Speed control	/ZCLAMP, C-SEL		
	n.□□9□	Torque control <=> Speed control	/ZCLAMP, C-SEL		
	n.□□A□	Speed control <=> Speed control with zero clamp function	/ZCLAMP, C-SEL		

Note: If Pn000.1 is set to 5, 6, 7, or 9, the zero clamp function will become invalid when the control is changed to any methods other than speed control and internal set speed control.

For speed control, the zero clamp function locks the servomotor when the speed reference drops below the set speed in the zero clamp level by setting Pn50D.0 to 7 (zero clamp function is always valid). The input signals (/ZCLAMP, /P-CON) are not necessary.

(3) Related Parameter

Set the motor speed at which to enter zero clamp operation.

Pn501	Zero Clamp Level				Classification
	Setting Range	Setting Unit	Factory Setting	When Enabled	
	0 to 10000	1 min ⁻¹	10	Immediately	Setup

Note: Even if a value that exceeds the maximum speed of the servomotor is set, the actual speed will be limited to the maximum speed of the servomotor.

5.3.6 Encoder Output Pulses

The encoder pulse output is a signal that is output from the encoder and processed inside the SERVOPACK. It is then output externally in the form of two phase pulse signal (phases A and B) with a 90° phase differential. It is used as the position feedback to the host controller.

Signals and output phase form are as shown below.

(1) Signals

Type	Signal Name	Connector Pin Number	Name	Remarks
Output	PAO	CN1-33	Encoder output pulse: phase A	These encoder pulse output pins output the number of pulses per motor revolution that is set in Pn212. Phase A and phase B are different from each other in phase by an electric angle of 90°.
	/PAO	CN1-34		
	PBO	CN1-35	Encoder output pulse: phase B	
	/PBO	CN1-36		
	PCO	CN1-19	Encoder output pulse: phase C	
	/PCO	CN1-20		

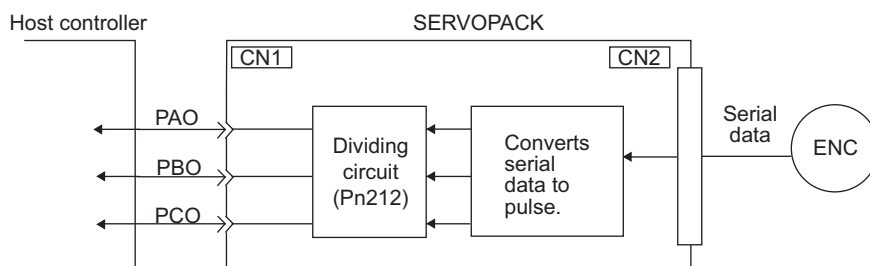

(2) Output Phase Form

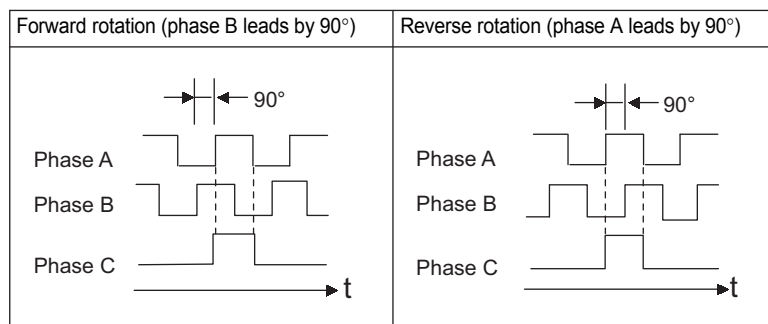

Note: The pulse width for phase C (origin pulse) changes according to the setting of the encoder output pulses (Pn212) and becomes the same as that for phase A.

Even in reverse rotation mode (Pn000.0 = 1), the output phase form is the same as that for the standard setting (Pn000.0 = 0) above.



IMPORTANT

If using the SERVOPACK's phase-C pulse output for a zero point return, rotate the servomotor two or more times before starting a zero point return. If the servomotor cannot be rotated two or more times, perform a zero point return at a motor speed of 600 min⁻¹ or below. If the motor speed is faster than 600 min⁻¹, the phase-C pulse may not be output correctly.

5.3.7 Setting Encoder Output Pulse

Set the encoder output pulse using the following parameter.

Pn212	Encoder Output Pulses Speed Position Torque				Classification
	Setting Range	Setting Unit	Factory Setting	When Enabled	
	16 to 1073741824	1 P/rev	2048	After restart	Setup

Pulses from the encoder per revolution are divided inside the SERVOPACK by the number set in this parameter before being output. Set the number of encoder output pulses according to the system specifications of the machine or host controller.

According to the encoder resolution, the number of encoder output pulses are limited.

Setting Range of Encoder Output Pulses (P/Rev)	Setting Unit	Encoder Resolution			Upper Limit of Servomotor Speed for Set Encoder Output Pulses (min^{-1})
		13 bits (8,192 pulses)	17 bits (131,072 pulses)	20 bits (1,048,576 pulses)	
16 to 2048	1	✓	–	–	6000
16 to 16384	1	–	✓	✓	6000
16386 to 32768	2	–	✓	✓	3000
32772 to 65536	4	–	–	✓	1500
65544 to 131072	8	–	–	✓	750
131088 to 262144	16	–	–	✓	375

- Note 1. The setting range varies with the encoder resolution for the servomotor used.
 An encoder output pulse setting error (A.041) will occur if the setting is outside the allowable range or does not satisfy the setting conditions.
 Pn212 = 25000 (P/Rev) is accepted, but
 Pn212 = 25001 (P/Rev) is not accepted. The alarm A.041 is output because the setting unit differs from that in the above table.
2. The upper limit of the pulse frequency is approx. 1.6 Mpps.
 The servomotor speed is limited if the setting value of the encoder output pulses (Pn212) is large.
 An overspeed of encoder output pulse rate alarm (A.511) will occur if the motor speed exceeds the upper limit specified in the above table.

Output Example: When Pn212 = 16 (16-pulse output per one revolution), PAO and PBO are output as shown below.

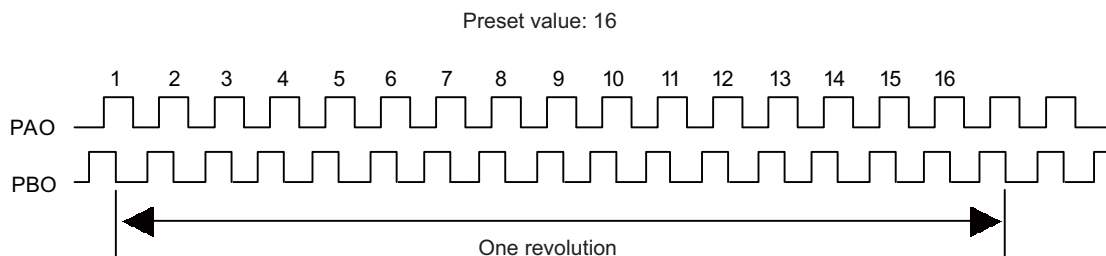

5.3.8 Setting Speed Coincidence Signal

The speed coincidence output signal (/V-CMP) is output when the actual servomotor speed is the same as the reference speed. The host controller uses the signal as an interlock. This signal is the output signal during speed control.

Type	Signal Name	Connector Pin Number	Setting	Meaning
Output	/V-CMP	CN1-25, 26 [Factory Setting]	ON (closed)	Speed coincides.
			OFF (open)	Speed does not coincide.

Note: Use parameter Pn50E.1 to allocate the /V-CMP signal to another terminal. Refer to 3.3.2 *Output Signal Allocations* for details.

Pn503	Speed Coincidence Signal Output Width Speed				Classification
	Setting Range	Setting Unit	Factory Setting	When Enabled	
	0 to 100	1 min ⁻¹	10	Immediately	Setup

The /V-CMP signal is output when the difference between the reference speed and actual motor speed is below this setting.

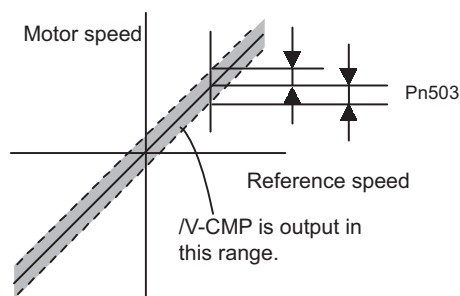

<Example>

The /V-CMP signal is output at 1900 to 2100 min⁻¹ if the Pn503 is set to 100 and the reference speed is 2000 min⁻¹.

5.4 Position Control

This section describes operation with position control.

Select position control with Pn000.1.

Parameter	Meaning	When Enabled	Classification
Pn000	n.□□1□	Position Control	After restart
			Setup

■ Block Diagram for Position Control

A block diagram for position control is shown below.

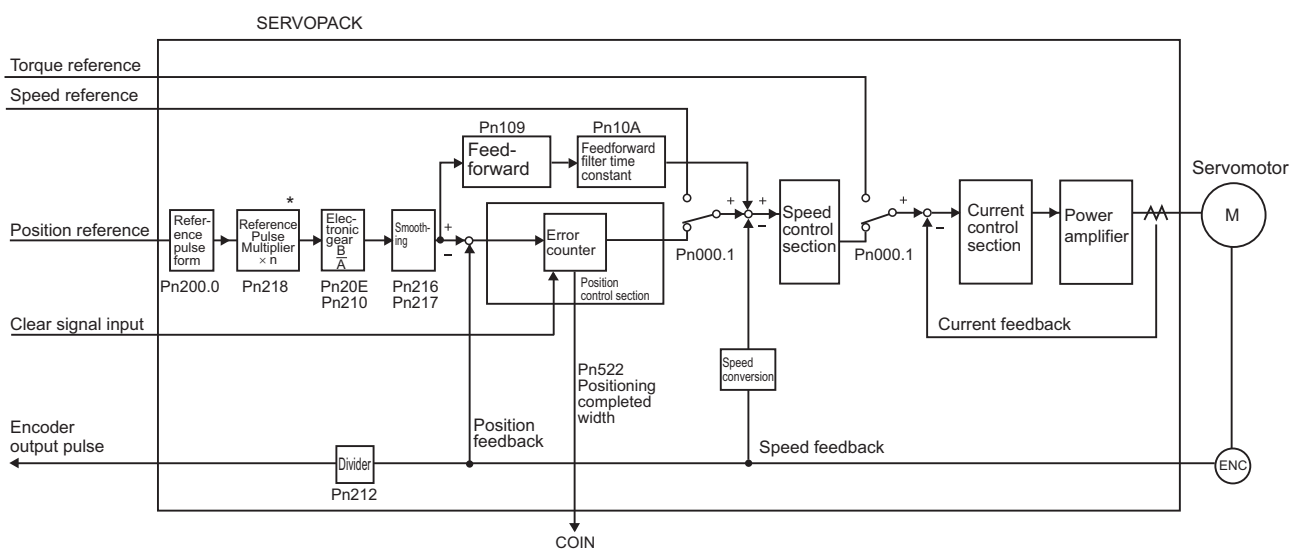

* The reference pulse input multiplication switching function is supported by software version 001A or later.

5.4.1 Basic Settings for Position Control

This section describes the basic settings for position control.

(1) Reference Pulse Form

Set the reference pulse form using Pn200.0.

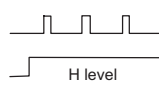
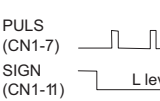
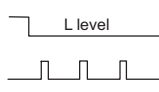
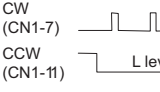
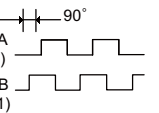
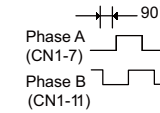
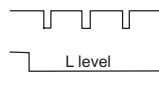
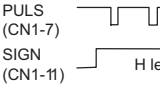
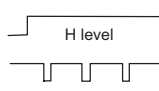
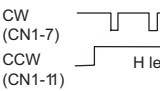
Parameter		Reference Pulse Form	Input Pulse Multiplier	Forward Run Reference	Reverse Run Reference
Pn200	n.□□□0 [Factory setting]	Sign + pulse train (Positive logic)	—	PULS (CN1-7) SIGN (CN1-11) 	PULS (CN1-7) SIGN (CN1-11) 
	n.□□□1	CW + CCW pulse train (Positive logic)	—	CW (CN1-7) CCW (CN1-11) 	CW (CN1-7) CCW (CN1-11) 
	n.□□□2	Two-phase pulse train with 90° phase differential	×1		
	n.□□□3		×2		
	n.□□□4		×4		
	n.□□□5	Sign + pulse train (Negative logic)	—	PULS (CN1-7) SIGN (CN1-11) 	PULS (CN1-7) SIGN (CN1-11) 
	n.□□□6	CW + CCW pulse train (Negative logic)	—	CW (CN1-7) CCW (CN1-11) 	CW (CN1-7) CCW (CN1-11) 

(2) Input Filter Selection

Parameter	Meaning	When Enabled	Classification
Pn200	n.0□□□ [Factory setting]	After restart	Setup
	n.1□□□		
	n.2□□□		

(3) Connection Example

The following diagram shows a connection example. Use an SN75ALS174 or MC3487 manufactured by Texas Instruments Inc., or equivalent for the line driver.

Line Driver Output

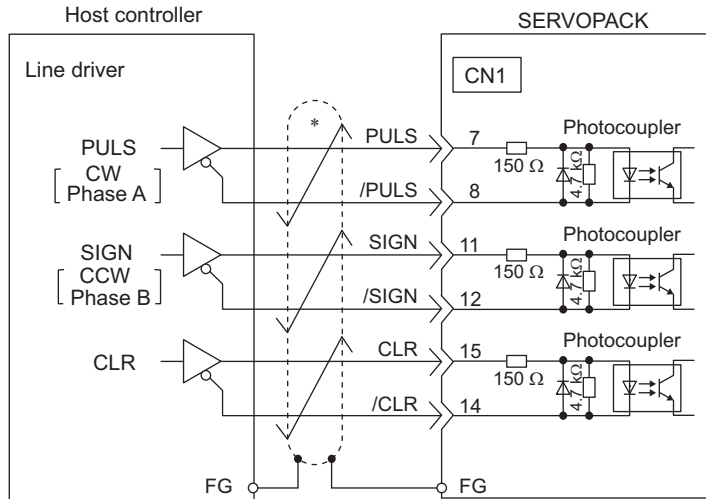

*  represents twisted-pair wires.

Open-collector Output

Set limit resistor R so the input current, i , falls between 7 mA to 15 mA.

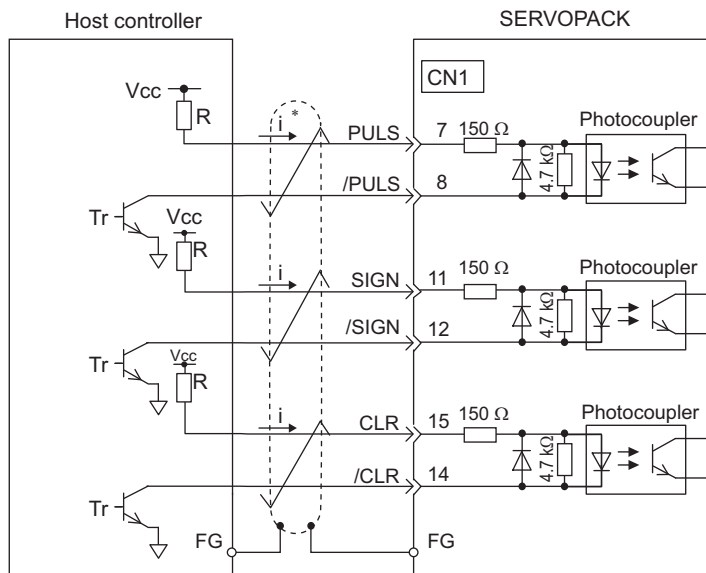

*  represents twisted-pair wires.

Example

- When V_{cc} is +24 V: $R = 2.2 \text{ k}\Omega$
- When V_{cc} is +12 V: $R = 1 \text{ k}\Omega$
- When V_{cc} is +5 V: $R = 180 \Omega$

Note: In case of open-collector outputs, the signal logic is as follows.

When Tr is ON	High level input or equivalent
When Tr is OFF	Low level input or equivalent





IMPORTANT

- Use a shielded cable for I/O signals and ground both ends of the shield.
- Connect the shield of the cable on the SERVOPACK side to the connector shell so that the shield will be connected to the frame ground (FG) through the connector.

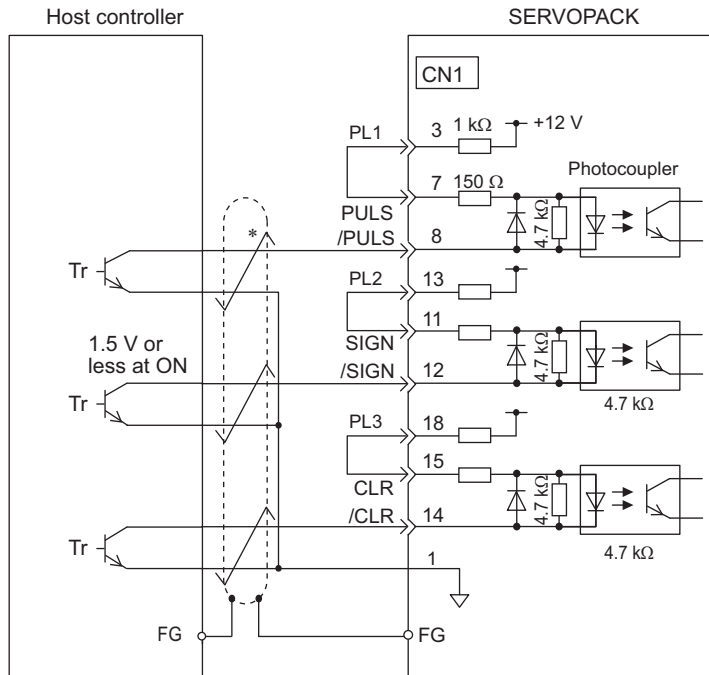
The built-in power supply of the SERVOPACK can be used. With an external power supply, a photocoupler isolation circuit will be used. A non-isolated circuit will be used if the built-in power supply is used.



*  represents twisted-pair wires.



IMPORTANT

- Use a shielded cable for I/O signals and ground both ends of the shield.
- Connect the shield of the cable on the SERVOPACK side to the connector shell so that the shield will be connected to the frame ground (FG) through the connector.

(4) Electrical Specifications for Pulse Train Reference

Forms of pulse train references are as shown below.

Pulse Train Reference Form	Electrical Specifications	Remarks
Sign + pulse train input (SIGN + PULS signal) Maximum reference frequency: 4 Mpps (Maximum reference frequency in case of open-collector output: 200 kpps)		Sign (SIGN) H = Forward reference L = Reverse reference
CW + CCW pulse train Maximum reference frequency: 4 Mpps (Maximum reference frequency in case of open-collector output: 200 kpps)		
Two-phase pulse train with 90° phase differential (phase A + phase B) Maximum reference frequency: 1 Mpps* (Maximum reference frequency in case of open-collector output: 200 kpps)		Reference pulse form is set with Pn200.0.

- * Each multiplier's maximum reference frequency before multiplication is 1 Mpps.
- ×1 input pulse multiplier: 1 Mpps
- ×2 input pulse multiplier: 1 Mpps
- ×4 input pulse multiplier: 1 Mpps

(5) I/O Signal Timing Example

I/O signal timing example is as shown below.

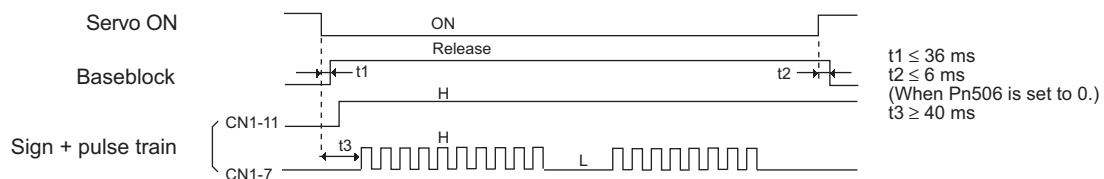

Note: The interval from the time the servo ON signal is turned ON until a reference pulse is input must be at least 40 ms. Otherwise the reference pulse may not be received by the SERVOPACK (t3).

5.4.2 Clear Signal Setting

Clear input signal sets SERVOPACK error counter to zero.

(1) Connecting the Clear Signal

Type	Signal Name	Connector Pin Number	Name
Input	CLR	CN1-15	Clear input
	/CLR	CN1-14	

(2) Clear Input Signal Form

Set the clear input signal form using Pn200.1.

Parameter	Description	Clear Timing	When Enabled	Classification	
Pn200	n.□□0□ [Factory setting]	Clears at ON. Position errors do not accumulate while the signal is ON.	CLR (CN1-15)	After restart	Setup
	n.□□1□	Clears at the rising edge.	CLR (CN1-15)		
	n.□□2□	Clears at OFF. Position errors do not accumulate while the signal is OFF.	CLR (CN1-15)		
	n.□□3□	Clears at the falling edge.	CLR (CN1-15)		

The following items will be changed in the SERVOPACK after the error counter has been reset to zero.

- The SERVOPACK error counter is set to 0.
- The position loop operation is disabled.

Note: Holding the clear status may cause the servolock to stop functioning and the servomotor to rotate slowly due to drift in the speed loop.

■ Pulse Width of Clear Signal

When parameter Pn200.1 is set to 0 or 2, the width of the clear signal must be at least 250 μ s to reset the error counter.

When parameter Pn200.1 is set to 1 or 3, the width of the clear signal must be at least 20 μ s to reset the error counter.

(3) Clear Operation

This parameter determines when the position error should be set to zero according to the condition of the SERVOPACK. Any of three clearing modes can be selected with Pn200.2.

Parameter	Description	When Enabled	Classification
Pn200	n.□0□□ [Factory setting]	After restart	Setup
	n.□1□□		
	n.□2□□		

5.4.3 Reference Pulse Input Multiplication Switching Function

The input multiplier for the position reference pulses can be switched between 1 and n ($n = 1$ to 100) by turning the Reference Pulse Input Multiplication Switching Input signal (/PSEL) ON and OFF. The Reference Pulse Input Multiplication Switching Output signal (/PSELA) can be used to confirm that the multiplier has been switched.

To use this function, set the multiplier in Pn218.

Switch the multiplier of the reference pulse only when the position reference pulse is 0. If the position reference pulse is not 0 when the multiplier is switched, the servomotor position may shift.

Note: The reference pulse input multiplication switching function is supported by software version 001A or later. The software version can be checked with Fn012. For details, refer to 7.14 *Software Version Display (Fn012)*.

 CAUTION	
<ul style="list-style-type: none"> Unexpected operation may occur if a position reference pulse is input before the multiplier changes. Always use the /PSELA signal to confirm that the multiplier has been switched before inputting a position reference pulse. If changing the setting of Pn218, disconnect the servomotor shaft from the machine and perform trial operation. Be sure that no problems will occur before connecting the shaft to the machine again. 	

(1) Related Parameter

Pn218	Reference Pulse Input Multiplication Position				Classification
	Setting Range	Setting Unit	Factory Setting	When Enabled	
	1 to 100	1 time	1	Immediately	Setup

(2) Timing Chart for Reference Pulse Input Multiplication Switching

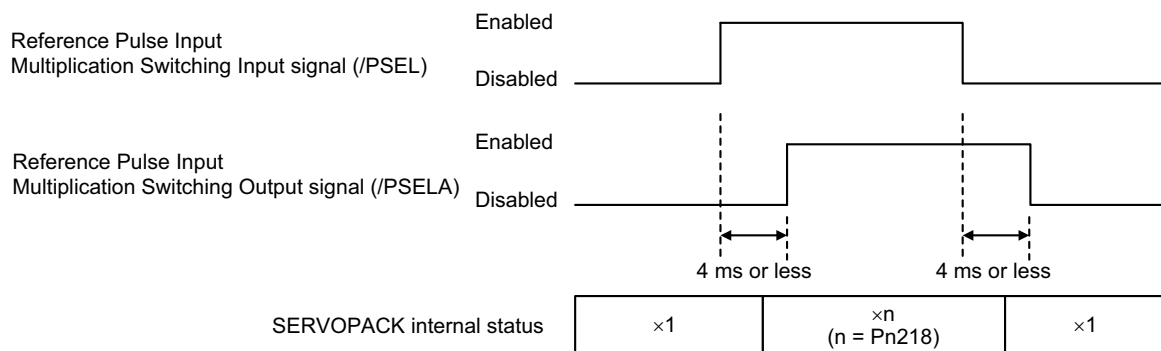

(3) Input Signal Setting

Use the /PSEL signal when switching to the multiplier of the input reference pulse that is set in Pn218.

Type	Signal Name	Connector Pin Number	Setting	Meaning
Input	/PSEL	Must be allocated	ON (closed)	Enables the multiplier of the input reference pulse.
			OFF (open)	Disables the multiplier of the input reference pulse.

Note: Use parameter Pn515.1 to allocate the /PSEL signal for use. For details, refer to 3.3.1 *Input Signal Allocations to Input Terminals*.

(4) Output Signal Setting

This output signal indicates when the multiplier of the input reference pulse has been switched for the Reference Pulse Input Multiplication Switching Input signal (/PSEL).

Type	Signal Name	Connector Pin Number	Setting	Meaning
Output	/PSELA	Must be allocated	ON (closed)	The multiplier of the input reference pulse is enabled.
			OFF (open)	The multiplier of the input reference pulse is disabled.

Note: Use parameter Pn510.2 to allocate the /PSELA signal for use. For details, refer to 3.3.2 *Output Signal Allocations*.

(5) Restriction

When using the following utility functions, the reference pulse input multiplication switching function is disabled.

Parameter No.	Function
Fn004	Program JOG operation
Fn201	Advanced autotuning

5.4.4 Electronic Gear

The electronic gear enables the workpiece travel distance per reference pulse input from the host controller. The minimum unit of the position data moving a load is called a reference unit.

Note: If the multiplier of the input reference pulse is switched, the input reference pulse from the host controller will be multiplied by n and defined as the reference unit of the position data. ("n" is the multiplier of the reference pulse.)

The section indicates the difference between using and not using an electronic gear when a workpiece is moved 10 mm in the following configuration.

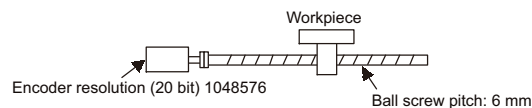

When the Electronic Gear is Not Used:

- ① Calculate the revolutions.
1 revolution is 6 mm. Therefore, $10 \div 6 = 10/6$ revolutions.
- ② Calculate the required reference pulses.
1048576 pulses is 1 revolution. Therefore, $10/6 \times 1048576 = 1747626.66$ pulses.
- ③ Input 1747627 pulses as reference pulses.

Reference pulses must be calculated per reference. → complicated

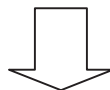

When the Electronic Gear is Used:

The reference unit is 1 μm . Therefore, to move the workpiece 10 mm (10000 μm),
1 pulse = 1 μm , so $10000 \div 1 = 10000$ pulses.
Input 10000 pulses.

Calculation of reference pulses per reference is not required. → simplified

(1) Electronic Gear Ratio

Set the electronic gear ratio using Pn20E and Pn210.

Pn20E	Electronic Gear Ratio (Numerator) Position				Classification
	Setting Range	Setting Unit	Factory Setting	When Enabled	
	1 to 1073741824	1	4	After restart	Setup
Pn210	Electronic Gear Ratio (Denominator) Position				Classification
	Setting Range	Setting Unit	Factory Setting	When Enabled	
	1 to 1073741824	1	1	After restart	Setup

If the gear ratio of the servomotor and the load shaft is given as n/m where m is the rotation of the servomotor and n is the rotation of the load shaft,

$$\text{Electronic gear ratio: } \frac{B}{A} = \frac{\text{Pn20E}}{\text{Pn210}} = \frac{\text{Encoder resolution}}{\text{Travel distance per load shaft revolution (reference units)}} \times \frac{m}{n}$$

■ Encoder Resolution

Encoder resolution can be checked with servomotor model designation.

SGM□V-□□□□□□□□

Symbol	Specification	Encoder Resolutions
3	20-bit absolute	1048576
D	20-bit incremental	1048576
A	13-bit incremental	8192

SGMPS -□□□□□□□□

Symbol	Specification	Encoder Resolutions
2	17-bit absolute	131072
C	17-bit incremental	131072

SGMCS -□□□□□□□□

Symbol	Specification	Encoder Resolutions
3	20-bit absolute	1048576
D	20-bit incremental	1048576



IMPORTANT

Electronic gear ratio setting range: $0.001 \leq \text{Electronic gear ratio (B/A)} \leq 4000$
If the electronic gear ratio is outside this range, a parameter setting error 1 (A.040) will be output.

(2) Electronic Gear Ratio Setting Examples

The following examples show electronic gear ratio settings for different load configurations.

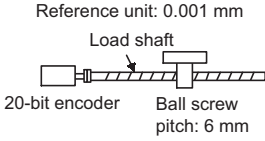
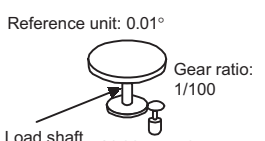
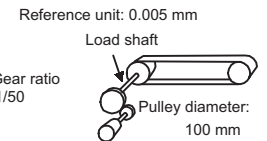
Step	Operation	Load Configuration				
		Ball Screw	Disc Table	Belt and Pulley		
		Reference unit: 0.001 mm  20-bit encoder Load shaft Ball screw pitch: 6 mm	Reference unit: 0.01°  Load shaft 20-bit encoder Gear ratio: 1/100	Reference unit: 0.005 mm  Load shaft Pulley diameter: 100 mm 20-bit encoder Gear ratio: 1/50		
1 Check machine specifications. • Ball screw pitch: 6 mm • Gear ratio: 1/1	1 Check the encoder resolution. 1048576 (20-bit)	1 Determine the reference unit used. Reference unit: 0.001 mm (1 μm)	1 Calculate the travel distance per load shaft revolution. (Reference unit) 6 mm/0.001 mm=6000	1 Calculate the electronic gear ratio. $\frac{B}{A} = \frac{1048576}{6000} \times \frac{1}{1}$	1 Rotation angle per revolution: 360° Gear ratio: 1/100	1 Pulley diameter: 100 mm (pulley circumference: 314 mm) • Gear ratio: 1/50
2 Calculate the electronic gear ratio. $\frac{B}{A} = \frac{1048576}{36000} \times \frac{100}{1}$	2 Set parameters. Pn20E: 1048576 Pn210: 6000	2 Reference unit: 0.01°	2 360°/0.01°=36000	2 $\frac{B}{A} = \frac{1048576}{62800} \times \frac{50}{1}$	2 Pn20E: 104857600 Pn210: 36000	2 1048576 (20-bit)
3 Determine the reference unit used. Reference unit: 0.001 mm (1 μm)	3 Calculate the electronic gear ratio. $\frac{B}{A} = \frac{1048576}{62800} \times \frac{50}{1}$	3 Reference unit: 0.01°	3 360°/0.01°=36000	3 Reference unit: 0.005 mm (5 μm)	3 Pn20E: 52428800 Pn210: 62800	3 1048576 (20-bit)
4 Calculate the travel distance per load shaft revolution. (Reference unit) 6 mm/0.001 mm=6000	4 Set parameters. Pn20E: 1048576 Pn210: 6000	4 Reference unit: 0.01°	4 360°/0.01°=36000	4 Reference unit: 0.005 mm (5 μm)	4 Pn20E: 52428800 Pn210: 62800	4 1048576 (20-bit)
5 Calculate the electronic gear ratio. $\frac{B}{A} = \frac{1048576}{62800} \times \frac{50}{1}$	5 Set parameters. Pn20E: 1048576 Pn210: 6000	5 Reference unit: 0.01°	5 360°/0.01°=36000	5 Reference unit: 0.005 mm (5 μm)	5 Pn20E: 52428800 Pn210: 62800	5 1048576 (20-bit)
6 Set parameters. Pn20E: 1048576 Pn210: 6000	6 Set parameters. Pn20E: 1048576 Pn210: 6000	6 Reference unit: 0.01°	6 360°/0.01°=36000	6 Reference unit: 0.005 mm (5 μm)	6 Pn20E: 52428800 Pn210: 62800	6 1048576 (20-bit)

5.4.5 Smoothing

Applying a filter to a reference pulse input, this function provides smooth servomotor operation in the following cases.

- When the host controller that outputs a reference cannot perform acceleration/deceleration processing.
- When the reference pulse frequency is too low.

Note: This function does not affect the travel distance (i.e., the number of reference pulses).

■ Related Parameters

Set the following filter-related parameters.

Change the setting while there is no reference pulse input and the servomotor stops.

Pn216	Position Reference Acceleration/Deceleration Time Constant Position				Classification
	Setting Range	Setting Unit	Factory Setting	When Enabled	
	0 to 65535	0.1 ms	0*	Immediately after the servomotor stops	Setup
Pn217	Average Movement Time of Position Reference Position				Classification
	Setting Range	Setting Unit	Factory Setting	When Enabled	
	0 to 10000	0.1 ms	0*	Immediately after the servomotor stops	Setup

* When set to 0, a filter becomes ineffective.



IMPORTANT While the servomotor is rotating, changes in Pn216 or Pn217 will not be reflected. The changes will be effective after the servomotor comes to a stop with no reference pulse input.

Note: The difference between the position reference acceleration/deceleration time constant (Pn216) and the average movement time of position reference (Pn217) is shown below.

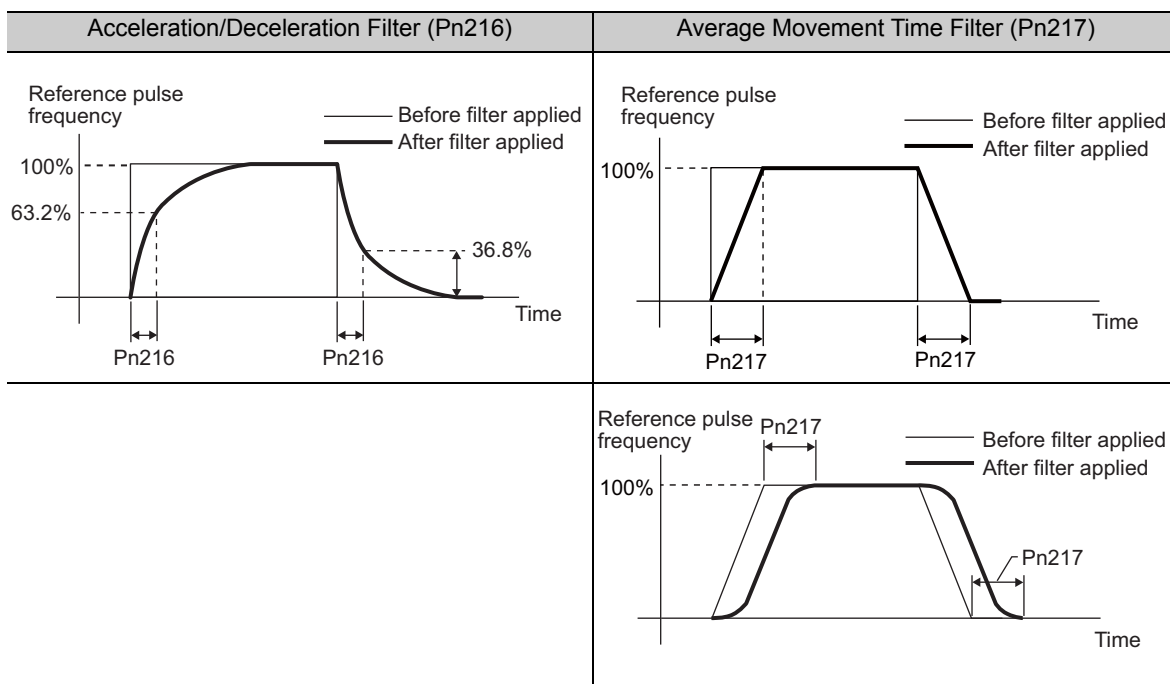

5.4.6 Positioning Completed Signal

This signal indicates that servomotor movement has been completed during position control.

When the difference between the number of reference pulses output by the host controller and the travel distance of the servomotor (position error) drops below the set value in the parameter, the positioning completion signal will be output.

Use this signal to check the completion of positioning from the host controller.

Type	Signal Name	Connector Pin Number	Setting	Meaning
Output	/COIN	CN1-25, 26 [Factory setting]	ON (closed)	Positioning has been completed.
			OFF (open)	Positioning is not completed.

Note: Use parameter Pn50E.0 to allocate the /COIN signal to another terminal. Refer to 3.3.2 *Output Signal Allocations* for details.

Pn522	Positioning Completed Width				Classification
	Setting Range	Setting Unit	Factory Setting	When Enabled	
	0 to 1073741824	1 reference unit	7	Immediately	Setup

The positioning completed width setting has no effect on final positioning accuracy.

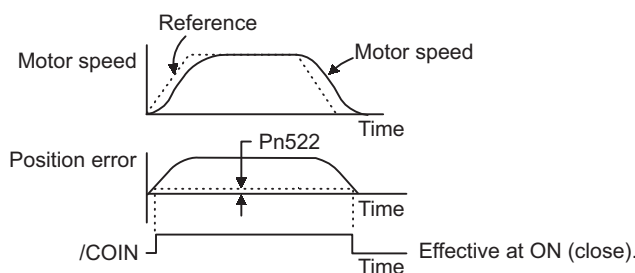

Note: If the parameter is set to a value that is too large, a positioning completed signal might be output if the position error is low during a low speed operation. This will cause the positioning completed signal to be output continuously. If this signal is output unexpectedly, reduce the set value until it is no longer output.

If the position error is kept to a minimum when the positioning completed width is small, use Pn207.3 to change output timing for the /COIN signal.

Parameter	Name	Meaning	When Enabled	Classification
Pn207	/COIN Output Timing	n.0□□□ [Factory setting]	After restart	Setup
		n.1□□□		
		n.2□□□		

5.4.7 Positioning Near Signal

Before confirming that the positioning completed signal has been received, the host controller first receives a positioning near signal and can prepare the operating sequence after positioning has been completed. The time required for this sequence after positioning can be shortened.

This signal is generally used in combination with the positioning completed output signal.

Type	Signal Name	Connector Pin Number	Setting	Meaning
Output	/NEAR	Must be allocated	ON (closed)	The servomotor has reached a point near to positioning completed.
			OFF (open)	The servomotor has not reached a point near to positioning completed.

Note: Use parameter Pn510.0 to allocate the /NEAR signal for use. Refer to 3.3.2 *Output Signal Allocations* for details.

Pn524	NEAR Signal Width				Classification
	Setting Range	Setting Unit	Factory Setting	When Enabled	
	1 to 1073741824	1 reference unit	1073741824	Immediately	Setup

The positioning near signal (/NEAR) is output when the difference between the number of reference pulses output by the host controller and the travel distance of the servomotor (position error) is less than the set value.

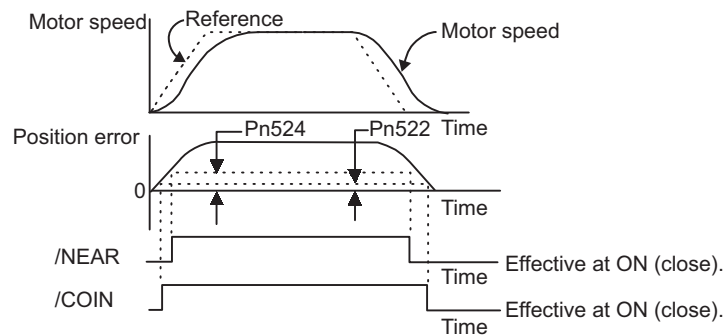

Note: Normally, the value of Pn524 should be larger than that for the positioning completed width (Pn522).

5.4.8 Reference Pulse Inhibit Function

This function inhibits the SERVOPACK from counting input pulses during position control. When this function is enabled, the SERVOPACK does not accept the reference pulse input.

(1) Factory-set Input Signal Allocations (Pn50A.0 = 0)

Use Pn000.1=B and the /P-CON signal to use the reference pulse inhibit function while the input signal allocations are still in the factory settings.

Type	Signal Name	Connector Pin Number	Setting	Meaning
Input	/P-CON	CN1-41 [Factory setting]	ON (closed)	Stops counting the reference pulses.
			OFF (open)	Counts the reference pulses.

Parameter	Control Method	Input Signal Used	When Enabled	Classification	
Pn000	n.□□B□	Position Control ↔ Position Control with Reference Pulse Inhibit Function	/P-CON	After restart	Setup

Note: If Pn000.1 is set to B, the /P-CON signal cannot be used for any function other than the reference pulse inhibit function.

(2) Changing Input Signal Allocations (Pn50A.0 = 1)

Allocate the /INHIBIT signal as the reference pulse inhibit signal to use the reference pulse inhibit function while the Pn000.1 (control method) is set to 1, 5, 7, or 8.

Type	Signal Name	Connector Pin Number	Setting	Meaning
Input	/INHIBIT	Must be allocated.	ON (closed)	Stops counting the reference pulses.
			OFF (open)	Counts the reference pulses.

Note: Use parameter Pn50D.1 to allocate the /INHIBIT signal for use. For details, refer to 3.3.1 *Input Signal Allocations to Input Terminals*.

To use the reference pulse inhibit function, set Pn000.1 to 1, 5, 7 or 8.

Parameter	Control Method	Input Signal Used	When Enabled	Classification	
Pn000	n.□□1□	Position Control	/INHIBIT	After restart	Setup
	n.□□5□	Internal Set Speed Control ↔ Position Control	/INHIBIT /SPD-A /SPD-B /SPD-D /C-SEL		
	n.□□7□	Position Control ↔ Speed Control	/INHIBIT /C-SEL		
	n.□□8□	Position Control ↔ Torque Control	/INHIBIT /C-SEL		

Note: Reference pulse inhibit function is effective only with position control.

5.5 Torque Control

This section describes operation with torque control.

Input the torque reference using analog voltage reference and control the servomotor operation with the torque in proportion to the input voltage.

Select the torque control with parameter Pn000.1.

Parameter	Meaning	When Enabled	Classification
Pn000	n.□□2□	Torque control	After restart
			Setup

5.5.1 Basic Settings for Torque Control

This section describes the basic settings for torque control.

(1) Signal Setting

Set the following input signals.

Type	Signal Name	Connector Pin Number	Name
Input	T-REF	CN1-9	Torque reference input
	SG	CN1-10	Signal ground for torque reference input

Maximum input voltage: ± 12 VDC

Input Circuit Example

Example

Pn400 = 0003.0 : Motor rated torque at 3.0 V [Factory setting]

Note: The value is 30, but it will be displayed on the operator as 0003.0.

Speed Reference Input	Rotation Direction	Torque
+3 V	Forward	Rated torque
+1 V	Forward	1/3 rated torque
-1.5 V	Reverse	1/2 rated torque

Connect the pins for the T-REF signal and SG to the analog reference output terminal on the host controller when using a host controller, such as a programmable controller, for torque control.

Note: Always use twisted-pair cables to control noise.

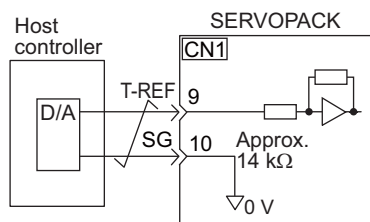

(2) Parameter Setting

Using Pn400, set the analog voltage level for the torque reference (T-REF) that is necessary to operate the servomotor at the rated torque.

Pn400	Torque Reference Input Gain				Classification	
			Speed	Position		Torque
	Setting Range	Setting Unit	Factory Setting	When Enabled		
	10 to 100	0.1 V/rated torque	30 (Rated torque at 3.0 V)	Immediately		
				Setup		

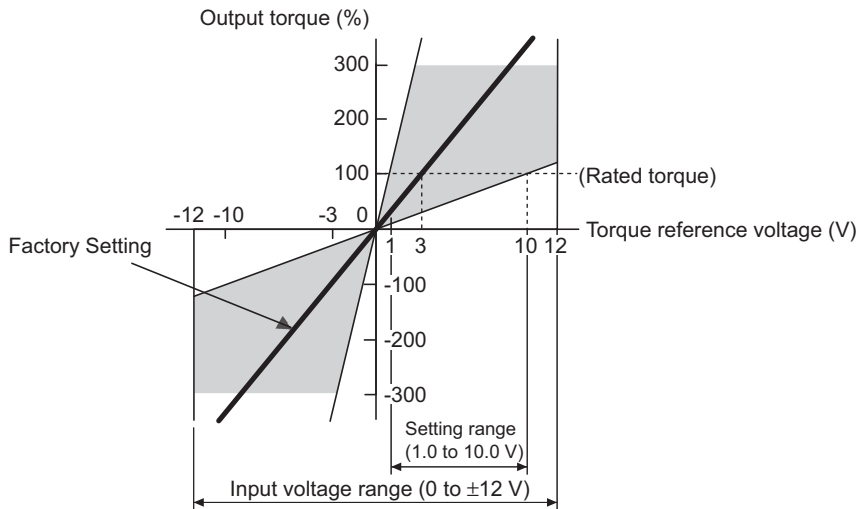

Note: A torque reference above the rated torque can be applied but it may cause an overload (high load) alarm (A.710) or overload (low load) alarm (A.720) if excessive torque is output for a long time. Refer to 10.1.2 *Troubleshooting of Alarms*.

5.5.2 Reference Offset Adjustment

In torque control, the servomotor may rotate at a very low speed with a voltage reference of 0 V. This occurs because the internal reference voltage of the SERVOPACK has a slight offset of a few millivolts. It is called "offset."

If the servomotor rotates at a very low speed, the offset needs to be eliminated with the offset adjustment function.

Use either automatic adjustment or manual adjustment. Automatic adjustment uses the automatic adjustment parameter for reference offset (Fn009). Manual adjustment uses the manual adjustment parameter for reference offset (Fn00B).

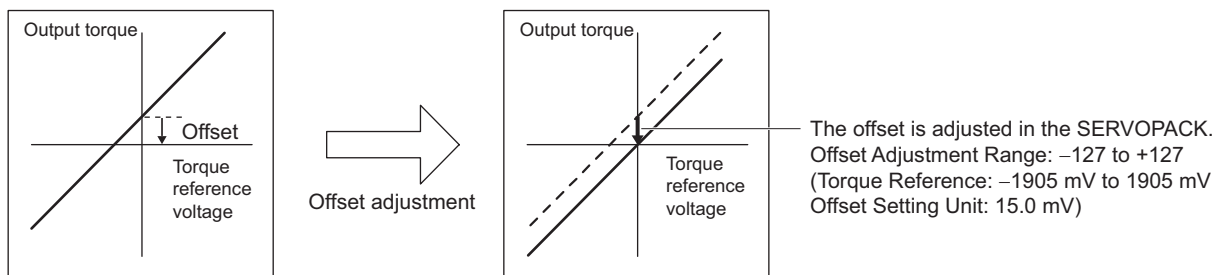

(1) Automatic Adjustment of Reference Offset (Fn009)

The automatic adjustment of reference offset measures the amount of offset and adjusts the reference voltage automatically.

After completion of the automatic adjustment, the amount of offset measured is saved in the SERVOPACK.



The servomotor power must be OFF when automatically adjusting the reference offset.

IMPORTANT

Note: The adjusted value is not initialized by executing the Fn005 function (Initializing Parameter Settings).









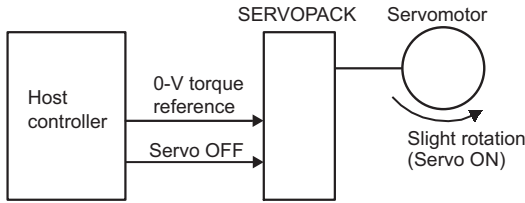

■ Preparation

The following conditions must be met to adjust the offsets of torque analog reference automatically. The message "NO-OP" indicating that the settings are not appropriate will be displayed, if the following conditions are not met.

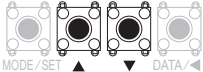
- The write prohibited setting parameter (Fn010) must be set to Write permitted (P.0000).
- The servomotor power must be OFF.

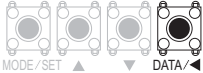
■ Operating Procedure

Adjust the reference offset automatically with the panel operator using the following steps.

Step	Display after Operation	Keys	Operation
1			Turn OFF the servo ON signal (/S-ON), and input the 0-V reference voltage from the host controller or external circuit. 
2			Press the MODE/SET Key to select the utility function.
3			Press the UP or the DOWN Key to select Fn009.
4			Press the DATA/SHIFT Key for approximately one second. "rEF_o" is displayed.
5			Press the MODE/SET key. After "donE" flashes for approximately one second, "rEF_o" is displayed again.
6			Press the DATA/SHIFT Key for approximately one second. "Fn009" is displayed again.

Note: The automatic adjustment of reference offset (Fn009) cannot be used when a position loop has been formed with the host controller. Use the manual adjustment of reference offset described in (2) *Manual Adjustment of Reference Offset (Fn00B)*.

(2) Manual Adjustment of Reference Offset (Fn00B)

This mode adjusts the offset by inputting the amount of torque reference offset directly.

Use the manual adjustment of the torque reference offset (Fn00B) in the following cases:

- To deliberately set the offset amount to some value.
- To check the offset amount set in the automatic adjustment mode of reference offset.

Note: The adjusted value is not initialized by executing the Fn005 function (Initializing Parameter Settings).

■ Preparation

The following conditions must be met to adjust the offsets of torque reference manually.

- The write prohibited setting parameter (Fn010) must be set to Write permitted (P.0000).
- The main circuit power supply must be ON. (Refer to 5.10.4.)

■ Operating Procedure

Adjust the reference offset manually with the panel operator using the following steps.

Step	Display after Operation	Keys	Operation
1			Press the MODE/SET Key to select the utility function.
2			Press the UP or the DOWN Key to select Fn00b.
3			Press the DATA/SHIFT Key for approximately one second. The display shown on the left appears. Note: When "no_oP" flashes for approximately one second, the write prohibited setting has been set in Fn010. Change the setting in Fn010 to enable writing. set (Refer to 7.12.)
4			Turn ON the servo ON signal (/S-ON) from an external device. The display shown on the left appears.
5			Press the DATA/SHIFT Key for approximately one second. The present offset amount is displayed.
6			Press the UP or the DOWN Key to adjust the amount of offset.
7			Press the MODE/SET Key. After "donE" flashes for approximately one second, the display shown on the left appears.
8			Press the DATA/SHIFT Key for approximately one second. "Fn00b" is displayed again.

5.5.3 Torque Reference Filter

This smooths the torque reference by applying a first order lag filter to the torque reference (T-REF) input.

Note: A setting value that is too large, however, will slow down response.
Check the response characteristics when setting this parameter.

Pn415	T-REF Filter Time Constant				Classification	
			<input type="checkbox"/> Speed	<input type="checkbox"/> Position		<input type="checkbox"/> Torque
	Setting Range	Setting Unit	Factory Setting	When Enabled		
	0 to 65535	0.01 ms	0	Immediately		
	Setup					

5.5.4 Speed Limit in Torque Control

This function limits the speed of the servomotor to protect the machine.

A servomotor in torque control is controlled to output the specified torque, but the motor speed is not controlled. Therefore, if an excessive reference torque is set for the load torque on the machinery side, the speed of the servomotor may increase greatly. If that may occur, use this function to limit the speed.

Note: The actual limit value of motor speed depends on the load conditions of the servomotor.

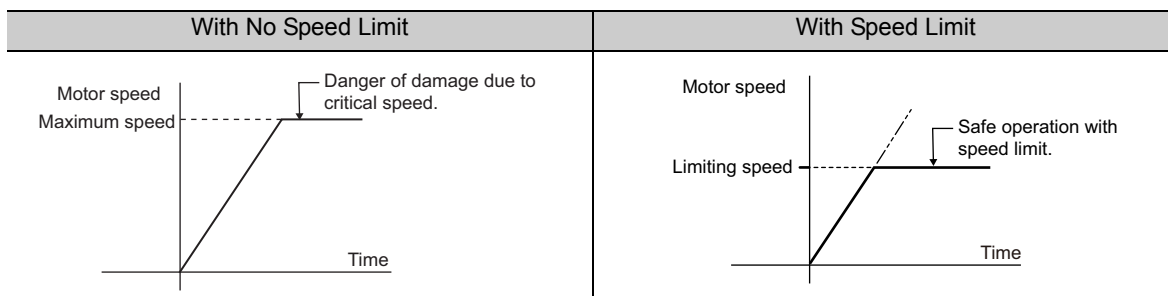

Refer to the following parameters for speed limit.

(1) Signals Output during Servomotor Speed Limit

The following signal is output when the motor speed reaches the limit speed.

Type	Signal Name	Connector Pin Number	Setting	Meaning
Output	/VLT	Must be allocated	ON (closed)	Servomotor speed limit being applied.
			OFF (open)	Servomotor speed limit not being applied.

Note: Use parameter Pn50F.1 to allocate the /VLT signal for use. For details, refer to 3.3.2 *Output Signal Allocations*.

(2) Speed Limit Setting

Select the speed limit mode with Pn002.1.

Parameter	Meaning	When Enabled	Classification
Pn002	n.□□0□ [Factory setting]	After restart	Setup
	n.□□1□		

■ Internal Speed Limit Function

If the internal speed limit function is selected in Pn002.1, set the limit of the maximum speed of the servomotor in Pn407. The limit of the speed in Pn408.1 can be either the maximum speed of the servomotor or the overspeed alarm detection speed. Select the overspeed alarm detection speed to limit the speed to the maximum speed of the servomotor or the equivalent.

Pn407	Speed Limit During Torque Control Torque				Classification
	Setting Range	Setting Unit	Factory Setting	When Enabled	
	0 to 10000	1 min ⁻¹	10000	Immediately	Setup

Note: The servomotor's maximum speed or the overspeed alarm detection speed will be used when the setting in this parameter exceeds the maximum speed of the servomotor used.

Parameter		Meaning	When Enabled	Classification
Pn408	n.□□0□ [Factory setting]	Uses the smaller value of the maximum motor speed and the value of Pn407 as the speed limit value.	After restart	Setup
	n.□□1□	Uses the smaller value of the overspeed alarm detection speed and the value of Pn407 as speed limit value.		

■ External Speed Limit Function

If the external speed limit function is selected in Pn002.1, set the V-REF input signal and Pn300.

Type	Signal Name	Connector Pin Number	Name
Input	V-REF	CN1-5	External speed limit input
	SG	CN1-6	Signal ground for external speed limit input

Inputs an analog voltage reference as the servomotor speed limit value during torque control.

Notes:

- The smaller value of the speed limit input from the V-REF and the value of Pn407 is enabled when Pn002.1 is set to 1.
- The setting in Pn300 determines the voltage level to be input as the limit value. Polarity has no effect.
- When Pn300 is set to 6.00 (factory setting) and 6 V is input to V-REF (CN1-5, 6), the speed is limited to the rated speed of the servomotor used.

Pn300	Speed Reference Input Gain Speed Position Torque				Classification
	Setting Range	Setting Unit	Factory Setting	When Enabled	
	150 to 3000	0.01 V/rated speed	600	Immediately	Setup

5.6 Internal Set Speed Control

This section describes operation using speed control with the internal set speeds.

This function enables an operation to be executed at a controlled speed. The speed, direction, or both are selected in accordance with a combination of input signals from an external source. Servomotor speed settings are made beforehand using the parameters in the SERVOPACK. Because the speed is controlled with a parameter in the SERVOPACK, an external pulse generator or a reference generator that controls speed is not needed.

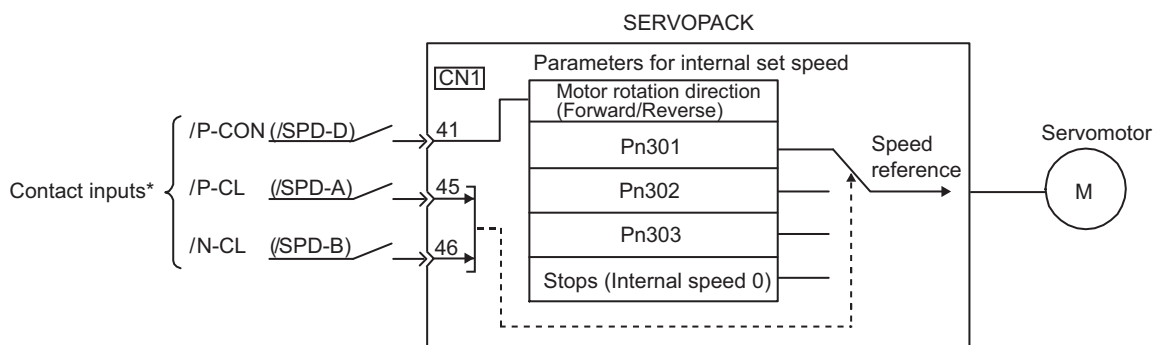

* When using the external input signal pins as factory settings, the functions of /P-CON, /P-CL, and /N-CL change to the functions of /SPD-D, /SPD-A, and /SPD-B, respectively.

5.6.1 Basic Settings for Speed Control with an Internal Set Speed

This section describes the basic settings for the internal set speeds.

(1) Signal Setting

The following input signals are used to switch the operating speed.

■ Factory-set Input Signal Allocations: /P-CON, /P-CL, and /N-CL

Type	Signal Name	Connector Pin Number	Meaning
Input	/P-CON	CN1-41	Switches the servomotor rotation direction.
	/P-CL	CN1-45	Selects the internal set speed.
	/N-CL	CN1-46	Selects the internal set speed.

■ Changing Input Signal Allocations: /SPD-D, /SPD-A, and /SPD-B

Type	Signal Name	Connector Pin Number	Meaning
Input	/SPD-D	CN1-41	Switches the servomotor rotation direction.
	/SPD-A	CN1-45	Selects the internal set speed.
	/SPD-B	CN1-46	Selects the internal set speed.

(2) Parameter Setting

Select the speed control with an internal set speed with Pn000.1.

Parameter	Meaning	When Enabled	Classification
Pn000	n.□□3□	Internal set speed control	After restart Setup

(3) Related Parameters

Set the internal set speed with Pn301, Pn302, and Pn303.

Pn301	Internal Set Speed 1 Speed				Classification
	Setting Range	Setting Unit*	Factory Setting	When Enabled	
	0 to 10000	1 min ⁻¹	100	Immediately	Setup
Pn302	Internal Set Speed 2 Speed				Classification
	Setting Range	Setting Unit*	Factory Setting	When Enabled	
	0 to 10000	1 min ⁻¹	200	Immediately	Setup
Pn303	Internal Set Speed 3 Speed				Classification
	Setting Range	Setting Unit*	Factory Setting	When Enabled	
	0 to 10000	1 min ⁻¹	300	Immediately	Setup

* When a direct drive motor (SGMCS) is connected, the setting unit will be automatically 0.1 min⁻¹.

Note: The maximum speed of the servomotor is used whenever the value which exceeds the maximum speed is set in the Pn301 to Pn303.

(4) Operating Using an Internal Set Speed

Use ON/OFF combinations of the following input signals to operate with the internal set speeds.

	Input Signal		Motor Rotation Direction	Speed
	/P-CON /SPD-D	/P-CL /SPD-A		
OFF	OFF	OFF	Forward	Stops at 0 of the internal set speed.
	OFF	ON		Pn301: Internal Set Speed 1
	ON	ON		Pn302: Internal Set Speed 2
	ON	OFF		Pn303: Internal Set Speed 3
ON	OFF	OFF	Reverse	Stops at 0 of the internal set speed.
	OFF	ON		Pn301: Internal Set Speed 1
	ON	ON		Pn302: Internal Set Speed 2
	ON	OFF		Pn303: Internal Set Speed 3

5.6.2 Example of Operating with Internal Set Speeds

An operating example of speed control with the internal set speeds is as shown below. This example combines speed control with the internal set speeds with the soft start function. The shock that results when the speed is changed can be reduced by using the soft start function.

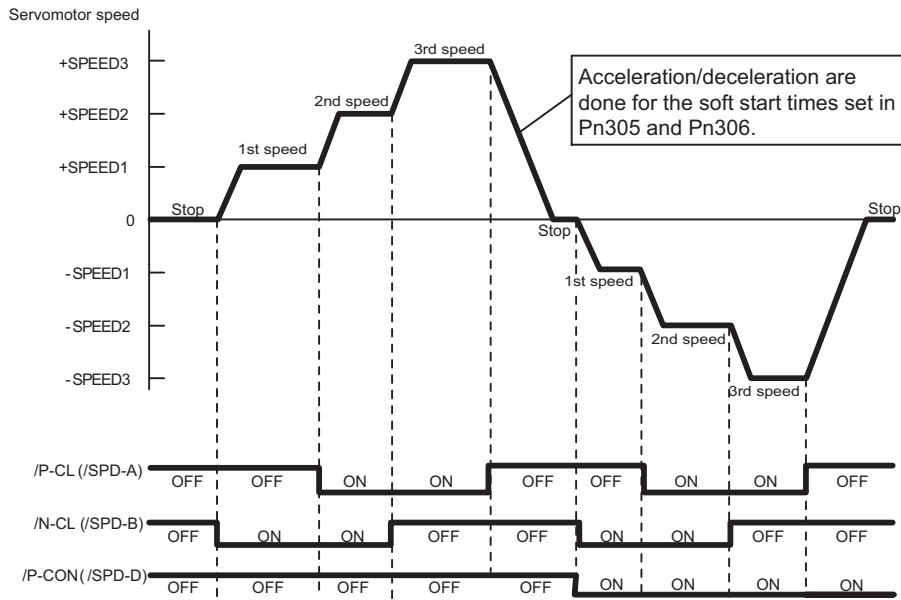

5.7 Combination of Control Methods

SERVOPACK can switch the combination of control methods. Select the control method with Pn000.1.

Parameter		Combination of Control Methods	When Enabled	Classification
Pn000	n.□□4□	Internal Set Speed Control ↔ Speed Control	After restart	Setup
	n.□□5□	Internal Set Speed Control ↔ Position Control		
	n.□□6□	Internal Set Speed Control ↔ Torque Control		
	n.□□7□	Position Control ↔ Speed Control		
	n.□□8□	Position Control ↔ Torque Control		
	n.□□9□	Torque Control ↔ Speed Control		
	n.□□A□	Speed Control ↔ Speed Control with Zero Clamp Function		
	n.□□B□	Position Control ↔ Position Control with Reference Pulse Inhibit Function		

5.7.1 Switching Internal Set Speed Control (Pn000.1 = 4, 5, or 6)

Conditions for switching internal set speed control are as shown below.

(1) Factory-set Input Signal Allocations (Pn50A.0 = 0)

The control method and internal set speed can be switched using /P-CL and /N-CL signals.

Input Signal			Pn000.1 Settings and Operations		
/P-CON (CN1-41)	/P-CL (CN1-45)	/N-CL (CN1-46)	n.□□4□	n.□□5□	n.□□6□
OFF	OFF	OFF	Speed control	Position control	Torque control
	OFF	ON	Forward rotation at internal set speed 1 set in Pn301.		
	ON	ON	Forward rotation at internal set speed 2 set in Pn302.		
	ON	OFF	Forward rotation at internal set speed 3 set in Pn303.		
ON	OFF	OFF	Speed control	Position control	Torque control
	OFF	ON	Reverse rotation at internal set speed 1 set in Pn301.		
	ON	ON	Reverse rotation at internal set speed 2 set in Pn302.		
	ON	OFF	Reverse rotation at internal set speed 3 set in Pn303.		

It is possible to switch from speed control, position control, or torque control to the internal set speed control even while the servomotor is rotating.

The following diagram describes an operation example for internal set speed control + soft start \Leftrightarrow position control.

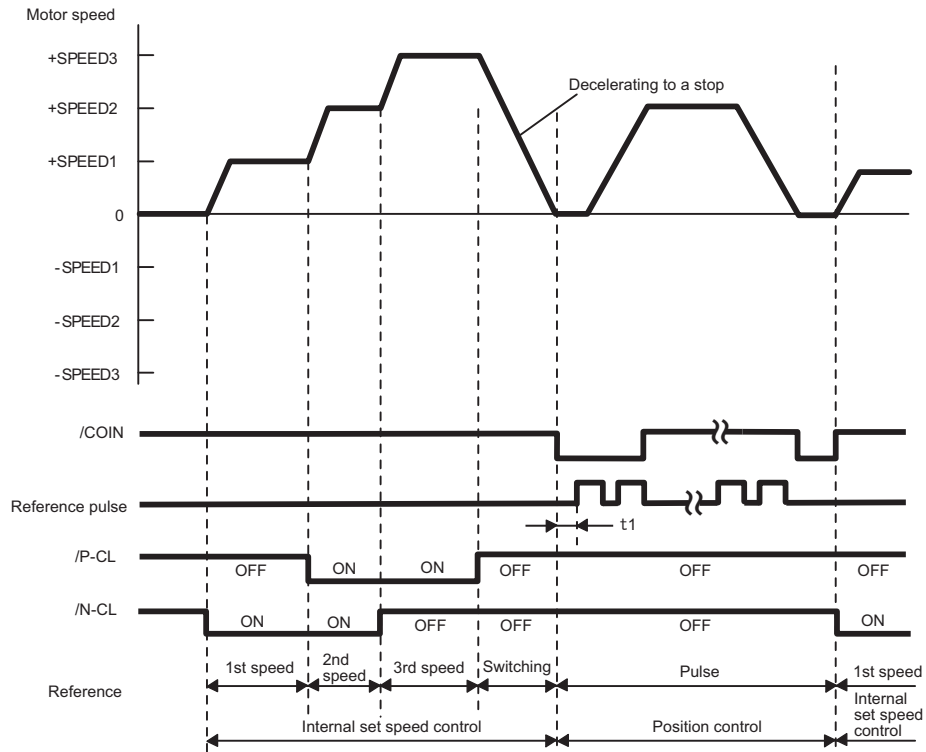

Note 1. The t_1 value is not affected by whether the soft start function is used.

A maximum delay of 2 ms occurs in loading /P-CL and /N-CL.

- The speed is decelerated for the time set in Pn306, and the internal set speed control will be changed to the position control after the servomotor comes to a stop.

(2) Changing Input Signal Allocations (Pn50A.0 = 1)

The control method can be switched by turning the /C-SEL signal ON/OFF.

Type	Signal Name	Connector Pin Number	Setting	Pn000 Setting and Control Method		
				n.□□4□	n.□□5□	n.□□6□
Input	/C-SEL	Must be allocated	ON (closed)	Speed	Position	Torque
			OFF (open)	Internal set speed	Internal set speed	Internal set speed

Note: Use parameter Pn50C.3 to allocate the /C-SEL signal for use. For details, refer to 3.3.1 *Input Signal Allocations*.

The following table shows the speed and direction in accordance with settings for the input signals for the setting for internal set speed control when the /C-SEL signal is OFF.

Input Signal			Speed and Direction
/SPD-D	/SPD-A	/SPD-B	
OFF	OFF	OFF	Stops at internal set speed 0.
	OFF	ON	Forward rotation at internal set speed 1 set in Pn301.
	ON	ON	Forward rotation at internal set speed 2 set in Pn302.
	ON	OFF	Forward rotation at internal set speed 3 set in Pn303.
ON	OFF	OFF	Stops at internal set speed 0.
	OFF	ON	Reverse rotation at internal set speed 1 set in Pn301.
	ON	ON	Reverse rotation at internal set speed 2 set in Pn302.
	ON	OFF	Reverse rotation at internal set speed 3 set in Pn303.

Note: Use parameter Pn50C.0 to 2 to allocate the /SPD-D, /SPD-A, and /SPD-B signals for use. For details, refer to 3.3.1 *Input Signal Allocations*.

5.7.2 Switching Other Than Internal Set Speed Control (Pn000.1 = 7, 8 or 9)

Use the following signals to switch control methods when Pn000.1 is set to 7, 8, or 9. The control methods switch depending on the signal status as shown below.

(1) Factory-set Input Signal Allocations (Pn50A.0 = 0)

Type	Signal Name	Connector Pin Number	Setting	Pn000.1 Setting and Control Method		
				n.□□7□	n.□□8□	n.□□9□
Input	/P-CON	CN1-41	ON (closed)	Speed	Torque	Speed
			OFF (open)	Position	Position	Torque

(2) Changing Input Signal Allocations (Pn50A.0 = 1)

Type	Signal Name	Connector Pin Number	Setting	Pn000.1 Setting and Control Method		
				n.□□7□	n.□□8□	n.□□9□
Input	/C-SEL	Must be allocated	ON (closed)	Speed	Torque	Speed
			OFF (open)	Position	Position	Torque

5.7.3 Switching Other Than Internal Set Speed Control (Pn000.1 = A or B)

Use the following signals to switch control methods when Pn000.1 is set to A or B. The control methods switch depending on the signal status as shown below.

(1) Factory-set Input Signal Allocations (Pn50A.0 = 0)

Type	Signal Name	Connector Pin Number	Setting	Pn000.1 Setting and Control Method	
				n.□□A□	n.□□B□
Input	/P-CON	CN1-41	ON (closed)	Speed control with zero clamp function	Position control with reference pulse inhibit function
			OFF (open)	Speed	Position

(2) Changing Input Signal Allocations for Each Signal (Pn50A.0 = 1)

Type	Signal Name	Connector Pin Number	Setting	Pn000.1 Setting and Control Method	
				n.□□A□	n.□□B□
Input	/ZCLAMP	Must be allocated	ON (closed)	Speed control with zero clamp function	–
			OFF (open)	Speed	–
	/INHIBIT		ON (closed)	–	Position control with reference pulse inhibit function
			OFF (open)	–	Position

5.8 Limiting Torque

The SERVOPACK provides the following four methods for limiting output torque to protect the machine.

Limiting Method	Description	Reference Section
Internal torque limit	Always limits torque by setting the parameter.	5.8.1
External torque limit	Limits torque by input signal from the host controller.	5.8.2
Torque limiting by analog voltage reference	Assigns a torque limit by analog voltage reference.	5.8.3
External torque limit + Torque limiting by analog voltage reference	Combines torque limiting by an external input and by analog voltage reference.	5.8.4

Note: The maximum torque of the servomotor is used when the set value exceeds the maximum torque.

5.8.1 Internal Torque Limit

This function always limits maximum output torque by setting values of following parameters.

Pn402	Forward Torque Limit Speed Position Torque				Classification
	Setting Range	Setting Unit	Factory Setting	When Enabled	
	0 to 800	1%	800	Immediately	Setup
Pn403	Reverse Torque Limit Speed Position Torque				Classification
	Setting Range	Setting Unit	Factory Setting	When Enabled	
	0 to 800	1%	800	Immediately	Setup

The setting unit is a percentage of the rated torque.

Note: If the settings of Pn402 and Pn403 are too low, the torque may be insufficient for acceleration or deceleration of the servomotor.

Torque waveform

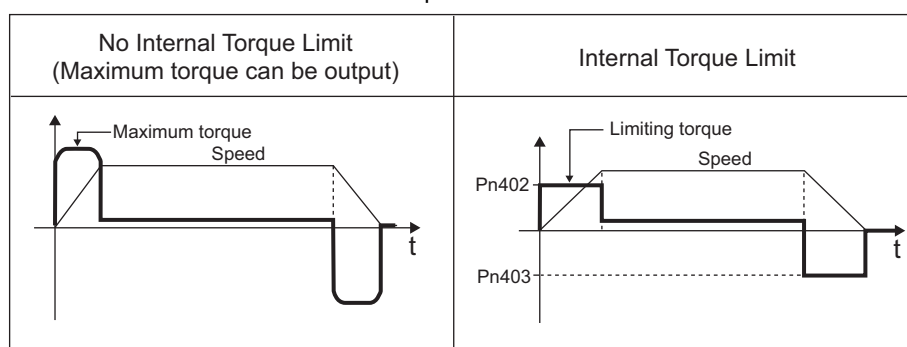

5.8.2 External Torque Limit

Use this function to limit torque by inputting a signal from the host controller at specific times during machine operation. For example, some pressure must continually be applied (but not enough to damage the workpiece) when the robot is holding a workpiece or when a device is stopping on contact.

(1) Input Signals

Use the following input signals to limit a torque by external torque limit.

Type	Signal Name	Connector Pin Number	Setting	Meaning	Limit value
Input	/P-CL	CN1-45 [Factory setting]	ON (closed)	Forward external torque limit ON	The smaller value of these settings: Pn402 or Pn404
			OFF (open)	Forward external torque limit OFF	Pn402
Input	/N-CL	CN1-46 [Factory setting]	ON (closed)	Reverse external torque limit ON	The smaller value of these settings: Pn403 or Pn405
			OFF (open)	Reverse external torque limit OFF	Pn403

Note: Use parameter Pn50B.2 and Pn50B.3 to allocate the /P-CL signal and the /N-CL signal to another terminal. For details, refer to 3.3.1 *Input Signal Allocations*.

(2) Related Parameters

Set the following parameters for external torque limit.

Pn402	Forward Torque Limit Speed Position Torque				Classification
	Setting Range	Setting Unit	Factory Setting	When Enabled	
	0 to 800	1%	800	Immediately	Setup
Pn403	Reverse Torque Limit Speed Position Torque				Classification
	Setting Range	Setting Unit	Factory Setting	When Enabled	
	0 to 800	1%	800	Immediately	Setup
Pn404	Forward External Torque Limit Speed Position Torque				Classification
	Setting Range	Setting Unit	Factory Setting	When Enabled	
	0 to 800	1%	100	Immediately	Setup
Pn405	Reverse External Torque Limit Speed Position Torque				Classification
	Setting Range	Setting Unit	Factory Setting	When Enabled	
	0 to 800	1%	100	Immediately	Setup

The setting unit is a percentage of the rated torque.

Note: If the settings of Pn402, Pn403, Pn404, and Pn405 are too low, the torque may be insufficient for acceleration or deceleration of the servomotor.

(3) Changes in Output Torque during External Torque Limiting

The following diagrams show the change in output torque when the internal torque limit is set to 800%.

In this example, the servomotor rotation direction is Pn000.0 = 0 (Sets CCW as forward direction).

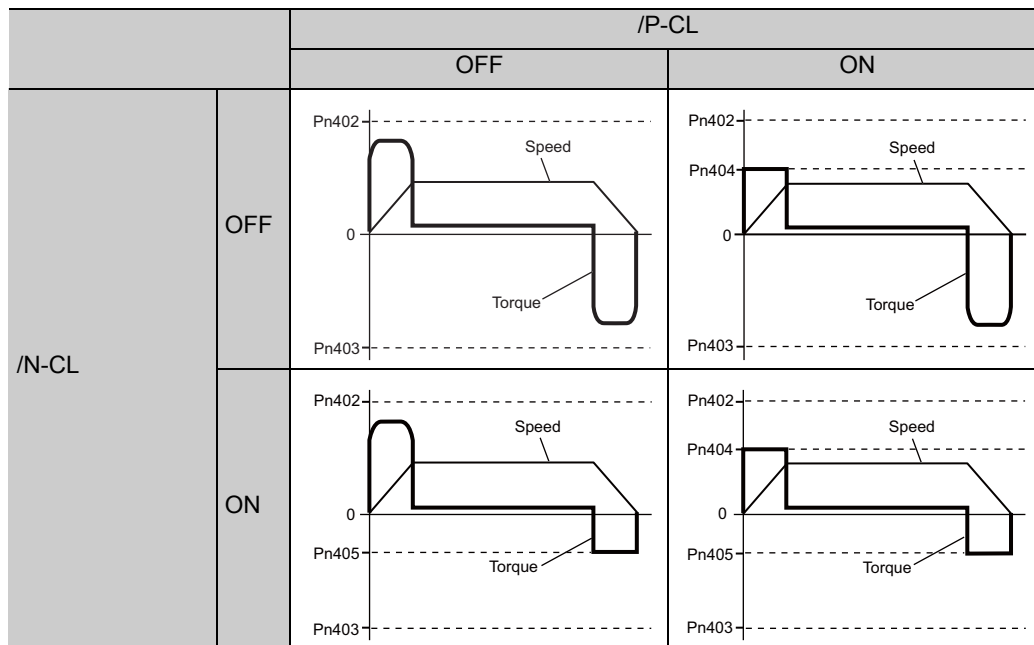

5.8.3 Torque Limiting Using an Analog Voltage Reference

For torque limiting by analog voltage reference, the torque is limited by using the analog voltage at the T-REF terminals for CN1-9 and CN1-10.

From the torque limit value by analog reference and torque limit value by Pn402 and Pn403, whichever is smaller will be applied.

Parameter		Meaning	When Enabled	Classification
Pn002	n.□□□1	Uses the T-REF terminal as an external torque limit input.	After restart	Setup

This function can be used only during speed or position control, not during torque control.

The following chart shows when the torque limiting using an analog voltage reference is performed in the speed control.

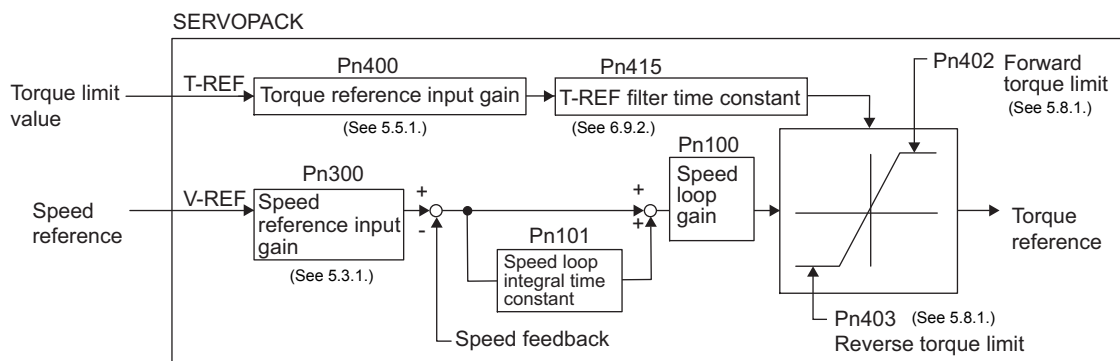

There is no polarity in the input voltage of the analog voltage reference for torque limiting. The absolute values of both + and - voltages are input, and a torque limit value corresponding to that absolute value is applied in the forward and reverse direction.

(1) Input Signals

Use the following input signals to limit a torque by analog voltage reference.

Type	Signal Name	Connector Pin Number	Name
Input	T-REF	CN1-9	Torque reference input
	SG	CN1-10	Signal ground for torque reference input

Refer to 5.5.1 *Basic Settings for Torque Control*.

(2) Related Parameters

Set the following parameters for torque limit by analog voltage reference.

Pn400	Torque Reference Input Gain Speed Position Torque				Classification
	Setting Range	Setting Unit	Factory Setting	When Enabled	
	10 to 100	0.1 V	30 (Rated torque at 3.0 V)	Immediately	Setup
Pn402	Forward Torque Limit Speed Position Torque				Classification
	Setting Range	Setting Unit	Factory Setting	When Enabled	
	0 to 800	1%	800	Immediately	Setup
Pn403	Reverse Torque Limit Speed Position Torque				Classification
	Setting Range	Setting Unit	Factory Setting	When Enabled	
	0 to 800	1%	800	Immediately	Setup
Pn415	T-REF Filter Time Constant Speed Position Torque				Classification
	Setting Range	Setting Unit	Factory Setting	When Enabled	
	0 to 65535	0.01 ms	0	Immediately	Setup

5.8.4 Torque Limiting Using an External Torque Limit and Analog Voltage Reference

This function can be used to combine torque limiting by an external input and by analog voltage reference.

When /P-CL (or /N-CL) is ON, either the torque limit by analog voltage reference or the setting in Pn404 (or Pn405) will be applied as the torque limit, whichever is smaller.

Parameter	Meaning	When Enabled	Classification
Pn002	n.□□□3	When /P-CL or /N-CL is enabled, the T-REF terminal is used as the external torque limit input.	After restart

The following chart shows the external torque limiting using an analog voltage reference.

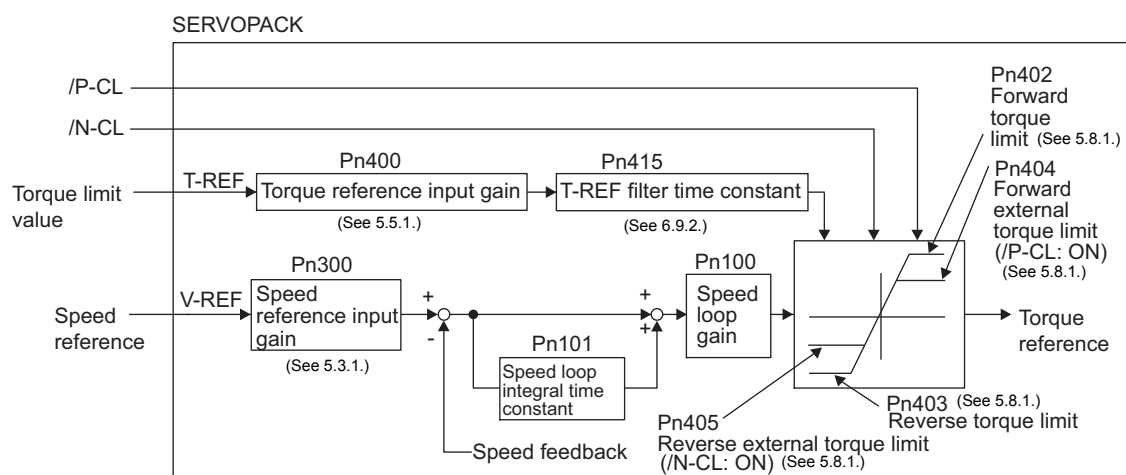

Note: This function cannot be used during torque control since the torque limit by analog voltage reference is input from T-REF (CN1-9, 10).

(1) Input Signals

Use the following input signals to limit a torque by external torque limit and analog voltage reference.

Type	Signal Name	Connector Pin Number	Name
Input	T-REF	CN1-9	Torque reference input
	SG	CN1-10	Signal ground for torque reference input

Refer to 5.5.1 Basic Settings for Torque Control.

Type	Signal Name	Connector Pin Number	Setting	Meaning	Limit Value
Input	/P-CL	CN1-45 [Factory setting]	ON	Forward external torque limit ON	The smallest value of these settings: the analog voltage reference limit, Pn402, or Pn404
			OFF	Forward external torque limit OFF	Pn402
Input	/N-CL	CN1-46 [Factory setting]	ON	Reverse external torque limit ON	The smallest value of these settings: the analog voltage reference limit, Pn403, or Pn405
			OFF	Reverse external torque limit OFF	Pn403

(2) Related Parameters

Set the following parameters for torque limit by external torque limit and analog voltage reference.

Pn400	Torque Reference Input Gain Speed Position Torque				Classification
	Setting Range	Setting Unit	Factory Setting	When Enabled	Setup
	10 to 100	0.1 V	30 (Rated torque at 3.0 V)	Immediately	
Pn402	Forward Torque Limit Speed Position Torque				Classification
	Setting Range	Setting Unit	Factory Setting	When Enabled	Setup
	0 to 800	1%	800	Immediately	
Pn403	Reverse Torque Limit Speed Position Torque				Classification
	Setting Range	Setting Unit	Factory Setting	When Enabled	Setup
	0 to 800	1%	800	Immediately	
Pn404	Forward External Torque Limit Speed Position Torque				Classification
	Setting Range	Setting Unit	Factory Setting	When Enabled	Setup
	0 to 800	1%	100	Immediately	
Pn405	Reverse External Torque Limit Speed Position Torque				Classification
	Setting Range	Setting Unit	Factory Setting	When Enabled	Setup
	0 to 800	1%	100	Immediately	

The setting unit is a percentage of the rated torque.

Pn415	T-REF Filter Time Constant Speed Position Torque				Classification
	Setting Range	Setting Unit	Factory Setting	When Enabled	Setup
	0 to 65535	0.01 ms	0	Immediately	

5.8.5 Checking Output Torque Limiting during Operation

The following signal can be output to indicate that the servomotor output torque is being limited.

Type	Signal Name	Connector Pin Number	Setting	Meaning
Output	/CLT	Must be allocated	ON (closed)	Servomotor output torque is being limited.
			OFF (open)	Servomotor output torque is not being limited.

Note: Use parameter Pn50F.0 to allocate the /CLT signal for use. For details, refer to 3.3.2 *Output Signal Allocations*.

5.9 Absolute Encoders

If using an absolute encoder, a system to detect the absolute position can be designed for use with the host controller. As a result, an operation can be performed without a zero point return operation immediately after the power is turned ON.

A battery case is required to save position data in the absolute encoder.
The battery is attached to the battery case of the encoder cable.

If an encoder cable with a battery case is not used, install a battery to the host controller.

⊘ PROHIBITED

- Do not install batteries in both the host controller and battery case. It is dangerous because that sets up a loop circuit between the batteries.

Note: The standard specification of the direct drive motor include an absolute encoder that shows values for a single rotation, so a battery case is not required for direct drive motors.

Also the following features are not required;

- Absolute encoder setup
- Multiturn limit setting

Set Pn002.2 to 0 (factory setting) to use the absolute encoder.

Parameter		Meaning	When Enabled	Classification
Pn002	n.□0□□ [Factory setting]	Uses the absolute encoder as an absolute encoder.	After restart	Setup
	n.□1□□	Uses the absolute encoder as an incremental encoder.		

The SEN signal and battery are not required when using the absolute encoder as an incremental encoder.



IMPORTANT

The output range of the rotational serial data for the Σ -V absolute position detecting system is different from that of earlier systems for 12-bit and 15-bit encoders. As a result, the infinite-length positioning system of the Σ Series must be changed for use with products in the Σ -V Series. Be sure to make the following system modification.

Servomotor Series	Resolution	Output Range of Rotational Serial Data	Action when Limit Is Exceeded
Σ Series SGD SGDA SGDB	12-bit 15-bit	-99999 to + 99999	<ul style="list-style-type: none"> • When the upper limit (+99999) is exceeded in the forward direction, the rotational serial data will be 0. • When the lower limit (-99999) is exceeded in the reverse direction, the rotational serial data will be 0.
Σ -II, Σ -III, Σ -V Series SGDM SGDH SGDS SGDV	17-bit 20-bit	-32768 to + 32767	<ul style="list-style-type: none"> • When the upper limit (+32767) is exceeded in the forward direction, the rotational serial data will be -32768.* • When the lower limit (-32768) is exceeded in the reverse direction, the rotational serial data will be +32767.*

* The action differs when the multiturn limit setting (Pn205) is changed. Refer to 5.9.6 *Multiturn Limit Setting*.

5.9.1 Connecting the Absolute Encoder

The following diagram shows the connection between a servomotor with an absolute encoder, the SERVOPACK, and the host controller.

(1) Using an Encoder Cable with a Battery Case

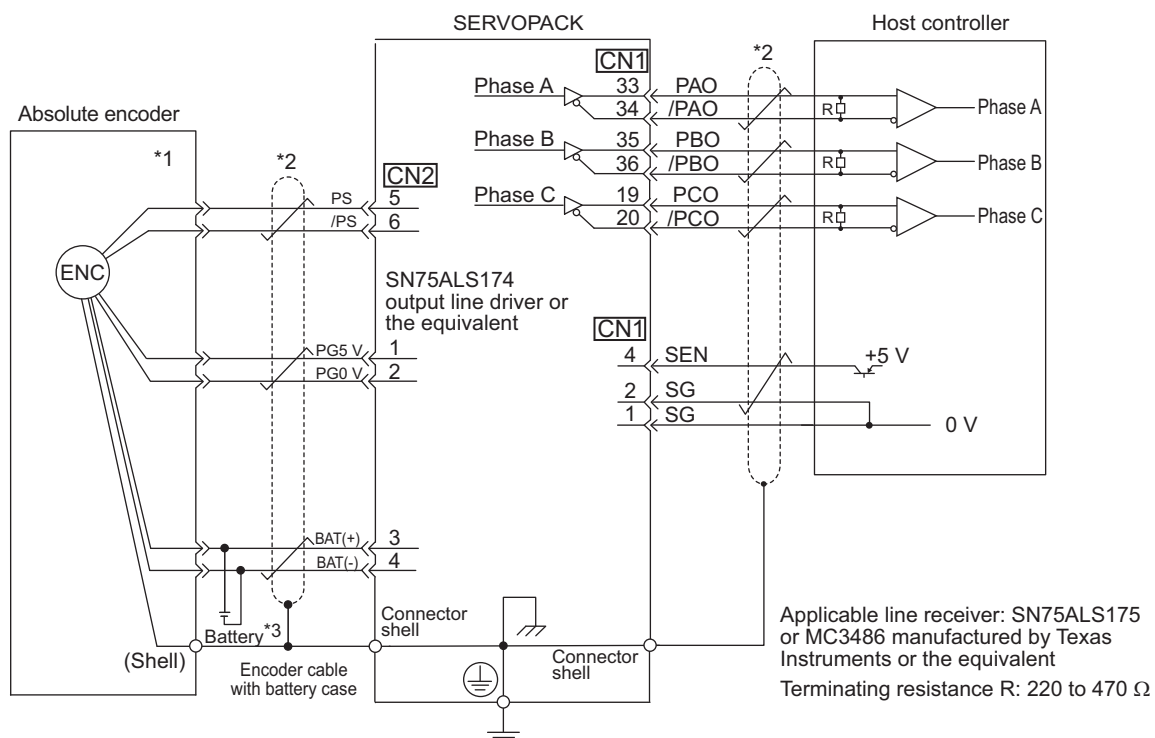

*1. The absolute encoder pin numbers for the connector wiring depend on the servomotors.

*2.  : represents shielded twisted-pair wires.

*3. When using an absolute encoder, provide power by installing an encoder cable with a JUSP-BA01-E Battery Case or install a battery on the host controller.

(2) Installing the Battery in the Host Controller

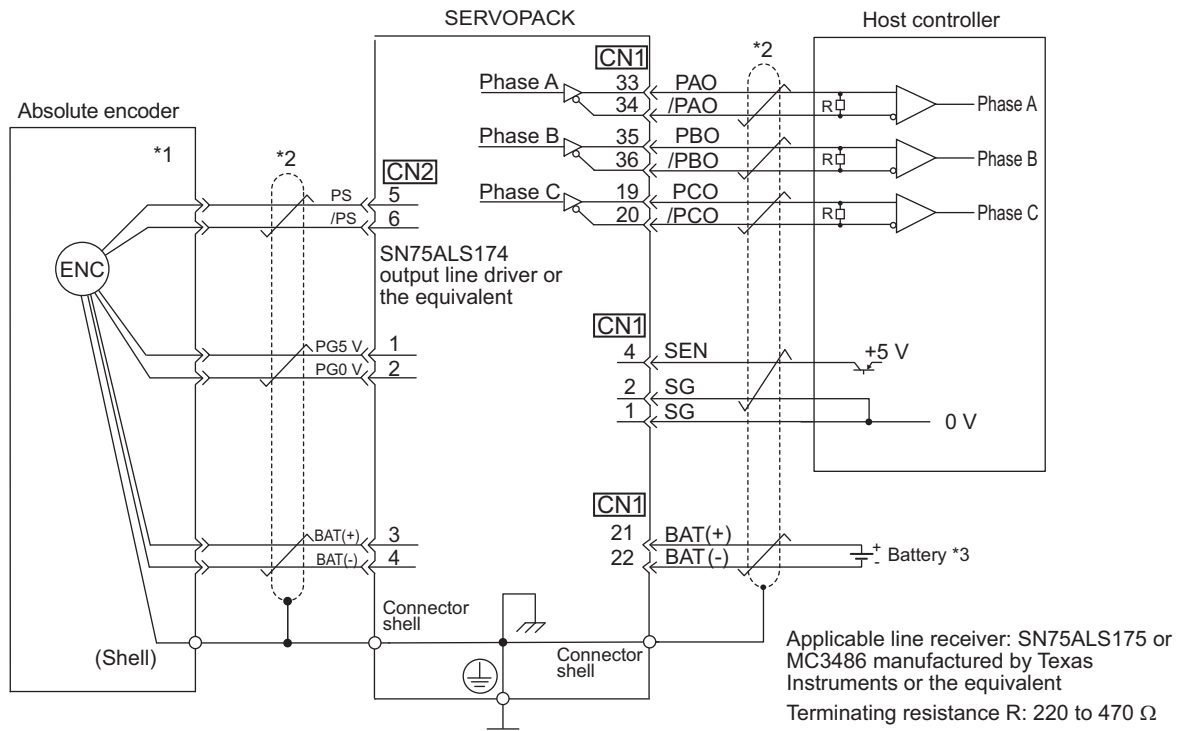

*1. The absolute encoder pin numbers for the connector wiring depend on the servomotors.

*2. : represents shielded twisted-pair wires.

*3. When using an absolute encoder, provide power by installing an encoder cable with a JUSP-BA01-E Battery Case or install a battery on the host controller.

5.9.2 Absolute Data Request Signal (SEN)

The absolute data request signal (SEN) must be input to obtain absolute data as an output from the SERVOPACK.

The following table describes the SEN signal.

Type	Signal Name	Connector Pin Number	Setting	Meaning
Input	SEN	CN1-4	OFF (low level)	Disabled
			ON (high level)	The host controller sends a request to the SERVOPACK for the absolute data.

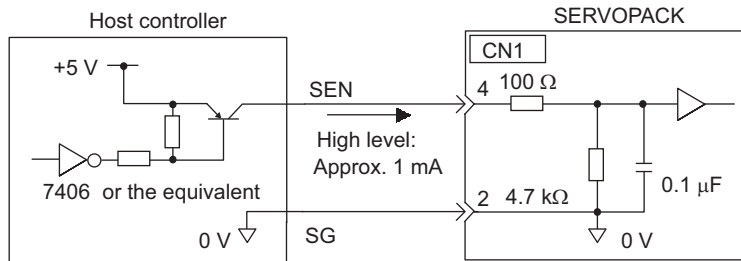

We recommend a PNP transistor.

The SEN signal is input at the following timing.

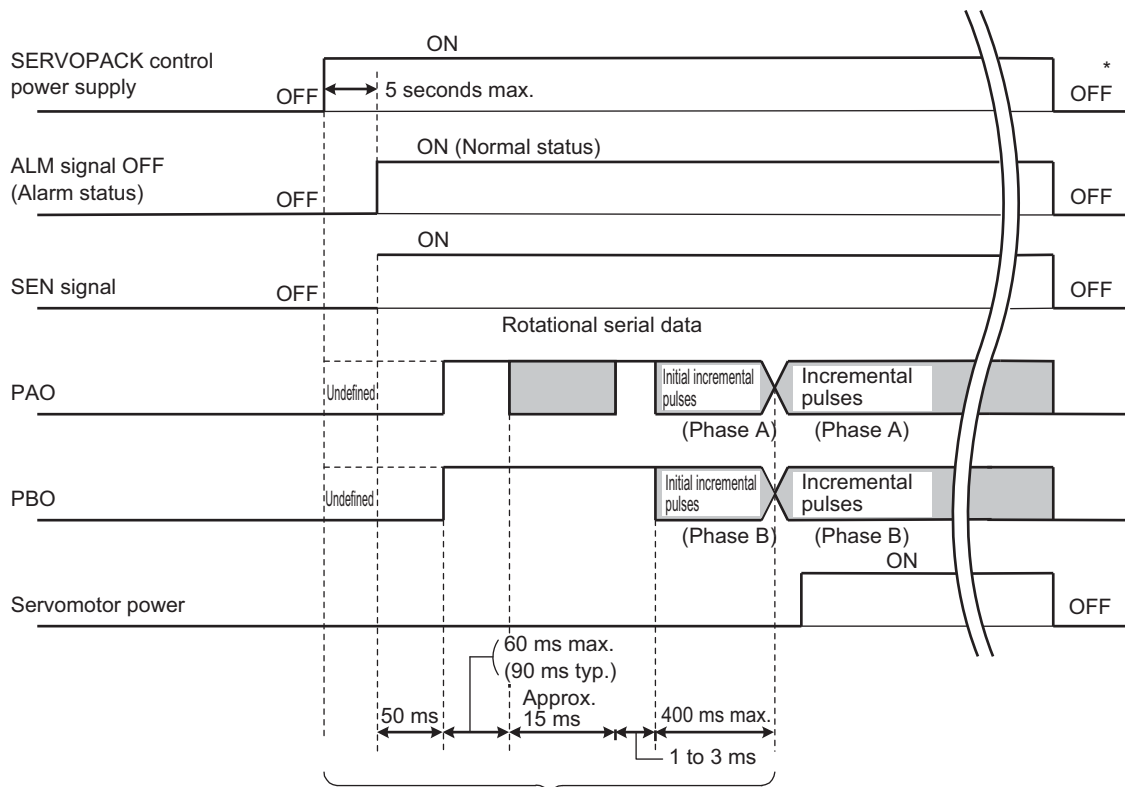

The servomotor will not be turned ON even if /S-ON is turned ON during this interval.

* Turn OFF the SEN signal to turn OFF the control power supply.



IMPORTANT

- Maintain the high level for at least 1.3 seconds when the SEN signal is turned OFF and then ON, as shown in the figure below.

SEN signal

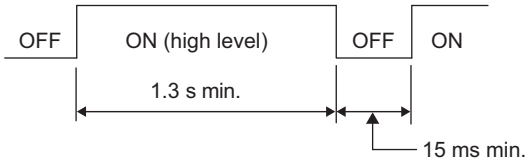

- SEN Signal cannot be OFF while the servomotor power is ON.

For the details of the absolute data reception sequence, refer to 5.9.5 *Absolute Data Reception Sequence*.

5.9.3 Battery Replacement

If the battery voltage drops to approximately 2.7 V or less, an absolute encoder battery error alarm (A.830) or an absolute encoder battery error warning (A.930) will be displayed.

If this alarm or warning is displayed, replace the batteries using the following procedure.

Use Pn008.0 to set either an alarm (A.830) or a warning (A.930).

Parameter	Meaning	When Enabled	Classification
Pn008	n.□□□0 [Factory setting]	After restart	Setup
	n.□□□1		

- If Pn008.0 is set to 0, alarm detection will be enabled for 4 seconds after the ALM signal outputs max. 5 seconds when the control power is turned ON. No battery-related alarm will be displayed even if the battery voltage drops below the specified value after these 4 seconds.
- If Pn008.0 is set to 1, alarm detection will be always enabled after the ALM signal outputs max. 5 seconds when the control power supply is turned ON.

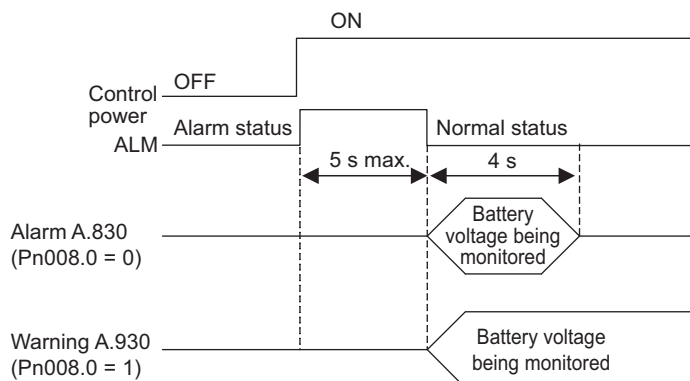

(1) Battery Replacement Procedure

■ Using an Encoder Cable with a Battery Case

1. Turn ON the control power supply of the SERVOPACK only.
2. Open the battery case cover.

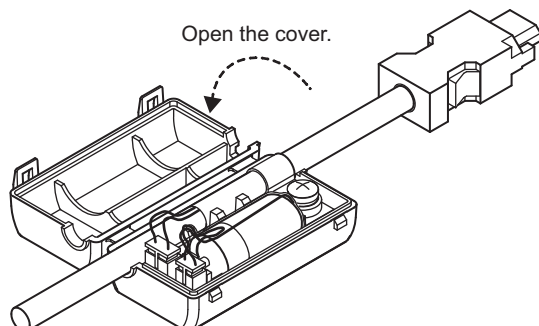

3. Remove the old battery and mount the new JZSP-BA01 battery as shown below.

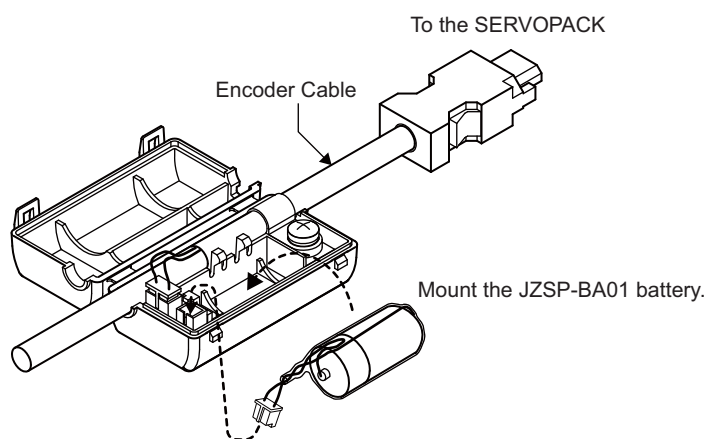

4. Close the battery case cover.

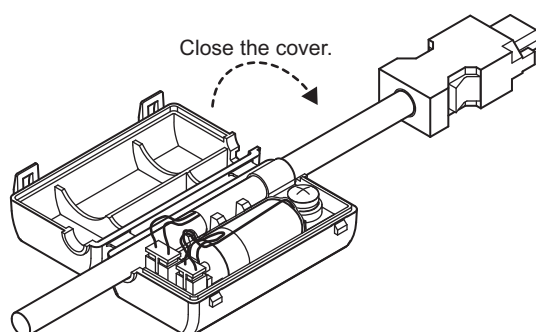

5. After replacing the battery, turn OFF the control power supply to clear the absolute encoder battery error alarm (A.830).
6. Turn ON the control power supply again.
7. Check that the alarm display has been cleared and that the SERVOPACK operates normally.



IMPORTANT

If the SERVOPACK control power supply is turned OFF and the battery is disconnected (which includes disconnecting the encoder cable), the absolute encoder data will be deleted.

■ **Installing a Battery in the Host Controller**

1. Turn ON the control power supply of the SERVOPACK only.
2. Remove the old battery and mount the new battery.
3. After replacing the battery, turn OFF the control power supply to clear the absolute encoder battery error alarm (A.830).
4. Turn ON the control power supply again.
5. Check that the alarm display has been cleared and that the SERVOPACK operates normally.

5.9.4 Absolute Encoder Setup and Reinitialization

⚠ CAUTION

- The rotational data will be a value between -2 and +2 rotations when the absolute encoder setup is executed. The reference position of the machine system will change. Set the reference position of the host controller to the position after setup.
If the machine is started without adjusting the position of the host controller, unexpected operation may cause injury or damage to the machine. Take sufficient care when operating the machine.

Setting up and reinitialization of the absolute encoder are necessary in the following cases.

- When starting the machine for the first time
- When an encoder backup error alarm (A.810) is generated
- When an encoder checksum error alarm (A.820) is generated
- When initializing the rotational serial data of the absolute encoder

Set up the absolute encoder with Fn008.

Note: The standard specification of the direct drive motor include an absolute encoder that shows values for a single rotation, so an encoder backup error alarm (A.810) will not occur for direct drive motors. Also, rotational serial data is always 0, so setting up the absolute encoder is not required.

(1) Precautions on Setup and Reinitialization

- The write prohibited setting parameter (Fn010) must be set to Write permitted (P.0000).
- Set up or reinitialize the encoder when the servomotor power is OFF.
- If the following absolute encoder alarms are displayed, cancel the alarm by using the same method as the set up (initializing) with Fn008. They cannot be canceled with the SERVOPACK alarm reset input signal (/ALM-RST).
 - Encoder backup error alarm (A.810)
 - Encoder checksum error alarm (A.820)
- Any other alarms (A.8□□) that monitor the inside of the encoder should be canceled by turning OFF the power.

(2) Procedure for Setup and Reinitialization

Follow the steps below to setup or reinitialize the absolute encoder.

Step	Display after Operation	Keys	Operation
1			Press the MODE/SET Key to select the utility function.
2			Press the UP or the DOWN Key to select Fn008.
3			Press the DATA/SHIFT Key for approximately one second. The display shown on the left appears.
4			Continue pressing the UP Key until "PGCL5" is displayed. Note: If the wrong key is pressed, "no-oP" will flash for about one second and it will return to the utility function. Start the operation from the beginning.
5			Press the MODE/SET Key. The absolute encoder is initialized. When completed, "donE" flashes for approximately one second.
6			Then, "donE" changes to "PGCL5".
7			Press the DATA/SHIFT Key for approximately one second. "Fn008" is displayed again.
8			To enable the change in the setting, turn the power OFF and ON again.

5.9.5 Absolute Data Reception Sequence

The sequence in which the SERVOPACK receives outputs from the absolute encoder and transmits them to host controller is shown below.

(1) Outline of Absolute Data

The serial data, pulses, etc., of the absolute encoder that are output from the SERVOPACK are output from the PAO, PBO, and PCO signals as shown below.

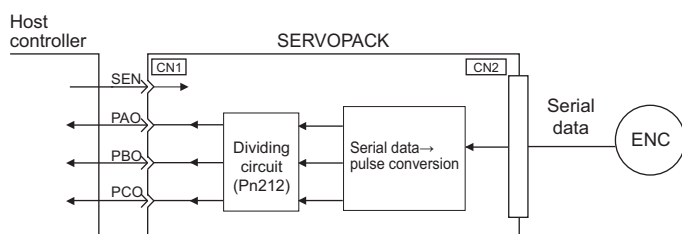

Signal Name	Status	Contents
PAO	At initialization	Rotational serial data Initial incremental pulses
	Normal Operations	Incremental pulses
PBO	At initialization	Initial incremental pulses
	Normal Operations	Incremental pulses
PCO	Always	Origin pulses

Phase-C Output Specifications

The pulse width of phase C (origin pulse) changes depending on the encoder output pulse (Pn212), becoming the same width as phase A.

The output timing is one of the following.

- Synchronized with the rising edge of phase A
- Synchronized with the falling edge of phase A
- Synchronized with the rising edge of phase B
- Synchronized with the falling edge of phase B

Note: When host controller receives the data of absolute encoder, do not perform counter reset using the output of PCO signal.

(2) Absolute Data Reception Sequence

1. Set the SEN signal at ON (high level).
2. After 100 ms, the system is set to rotational serial data reception standby and the incremental pulse up/down counter is cleared to zero.
3. Eight characters of rotational serial data is received.
4. The system enters a normal incremental operation state about 400 ms after the last rotational serial data is received.

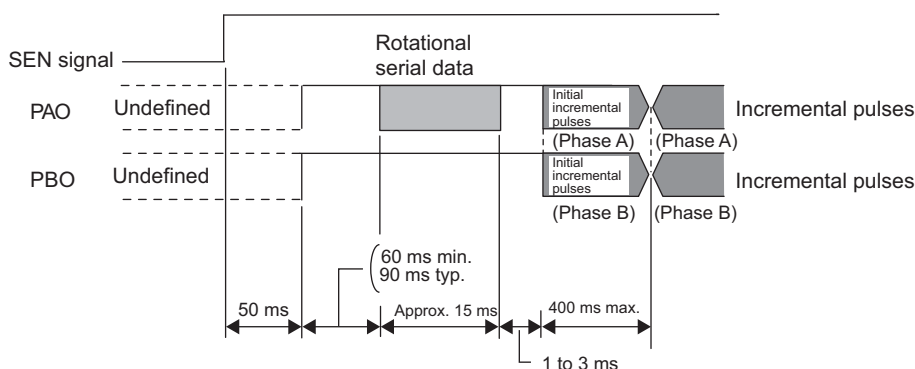

Note: The output pulses are phase-B advanced if the servomotor is turning forward regardless of the setting in Pn000.0.

Rotational serial data:

Indicates how many turns the motor shaft has made from the reference position, which was the position at setup.

Initial incremental pulses:

Initial incremental pulses which provide absolute data are the number of pulses required to rotate the motor shaft from the servomotor origin to the present position.

Just as with normal incremental pulses, these pulses are divided by the dividing circuit inside the SERVO-PACK and then output.

The initial incremental pulse speed depends on the setting of the encoder output pulses (Pn212). Use the following formula to obtain the initial incremental pulse speed.

Setting of the Encoder Output Pulses (Pn212)	Formula of the Initial Incremental Pulse Speed
16 to 16384	$\frac{680 \times Pn212}{16384}$ [kpps]
16386 to 32768	$\frac{680 \times Pn212}{32768}$ [kpps]
32772 to 65536	$\frac{680 \times Pn212}{65536}$ [kpps]
65544 to 131072	$\frac{680 \times Pn212}{131072}$ [kpps]
131088 to 262144	$\frac{680 \times Pn212}{262144}$ [kpps]

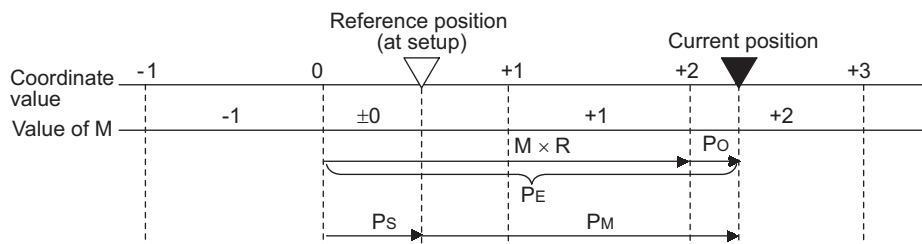

Final absolute data P_M is calculated by following formula.

$$P_E = M \times R + P_O$$

$$P_S = M_S \times R + P_S'$$

$$P_M = P_E - P_S$$

Signal	Meaning
P_E	Current value read by encoder
M	Rotational serial data
P_O	Number of initial incremental pulses
P_S	Absolute data read at setup (This is saved and controlled by the host controller.)
M_S	Rotational data read at setup
P_S'	Number of initial incremental pulses read at setup
P_M	Current value required for the user's system
R	Number of pulses per encoder revolution (pulse count after dividing, value of Pn212)

Note: The following formula applies in reverse mode. (Pn000.0 = 1)

$$P_E = -M \times R + P_O$$

$$P_S = M_S \times R + P_S'$$

$$P_M = P_E - P_S$$

(3) Rotational Serial Data Specifications and Initial Incremental Pulses

■ Rotational Serial Data Specifications

The rotational serial data is output from PAO signal.

Data Transfer Method	Start-stop Synchronization (ASYNC)
Baud rate	9600 bps
Start bits	1 bit
Stop bits	1 bit
Parity	Even
Character code	ASCII 7-bit code
Data format	8 characters, as shown below. <div style="text-align: center;"> </div> <p>Note 1. Data is "P+00000" (CR) or "P-00000" (CR) when the number of revolutions is zero. Note 2. The revolution range is "-32768" to "+32767". When this range is exceeded, the data changes from "+32767" to "-32678" or from "-32678" to "+32767". When changing multiturn limit, the range changes. For details, refer to 5.9.6 Multiturn Limit Setting.</p>

■ Initial Incremental Pulses

The initial incremental pulses are output after division inside the SERVOPACK in the same way as for normal incremental pulses. Refer to 5.3.6 Encoder Output Pulses for details.

(4) Transferring Alarm Contents

If an absolute encoder is used, the contents of alarms detected by the SERVOPACK are transmitted in serial data to the host controller from the PAO output when the SEN signal changes from high level to low level.

Note: The SEN signal cannot be OFF while the servomotor power is ON.

Output example of alarm contents are as shown below.

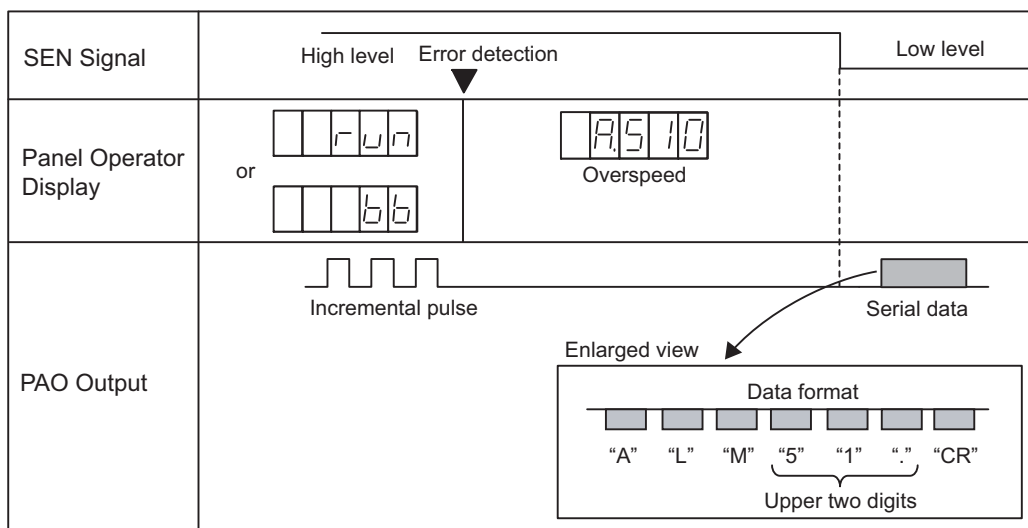

5.9.6 Multiturn Limit Setting

The multiturn limit setting is used in position control applications for a turntable or other rotating device. For example, consider a machine that moves the turntable in the following diagram in only one direction.

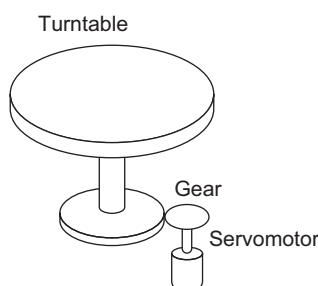

Because the turntable moves in only one direction, the upper limit for revolutions that can be counted by an absolute encoder will eventually be exceeded. The multiturn limit setting is used in cases like this to prevent fractions from being produced by the integral ratio of the motor revolutions and turntable revolutions.

For a machine with a gear ratio of $n:m$, as shown above, the value of m minus 1 will be the setting for the multiturn limit setting (Pn205).

Multiturn limit setting (Pn205) = $m-1$

The case in which the relationship between the turntable revolutions and motor revolutions is $m = 100$ and $n = 3$ is shown in the following graph.

Pn205 is set to 99.

$Pn205 = 100 - 1 = 99$

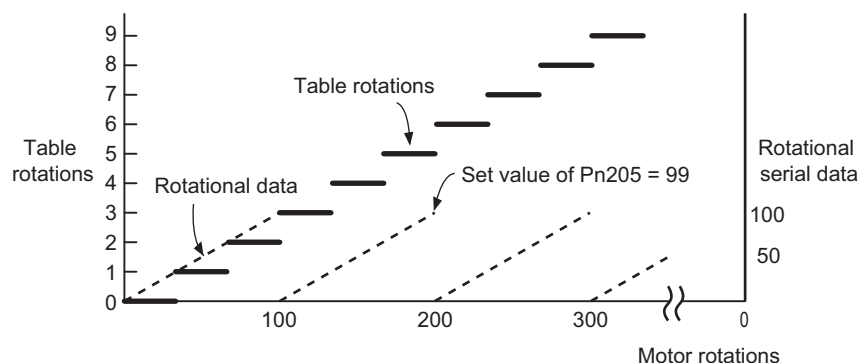

Pn205	Multiturn Limit Setting				Classification	
			<input type="checkbox"/> Speed	<input type="checkbox"/> Position		<input type="checkbox"/> Torque
	Setting Range	Setting Unit	Factory Setting	When Enabled		
	0 to 65535	1 Rev	65535	After restart	Setup	

Note: This parameter is valid when the absolute encoder is used.

The range of the data will vary when this parameter is set to anything other than the factory setting.

1. When the motor rotates in the reverse direction with the rotational data at 0, the rotational data will change to the setting of Pn205.
2. When the motor rotates in the forward direction with the rotational data at the Pn205 setting, the rotational data will change to 0.

Set the value, the desired rotational amount -1, to Pn205.

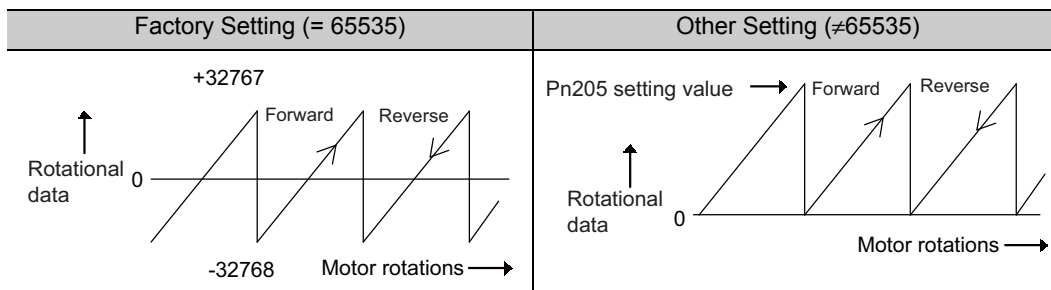

Note: The standard specification of the direct drive motor include an absolute encoder that shows values for a single rotation, so the multiturn data (rotational serial data) for the encoder is always 0. The absolute value of the load side can be created with the motor shaft angle only even when constructing an absolute position detecting system because the servomotor and the load can be directly connected.

5.9.7 Multiturn Limit Disagreement Alarm (A.CC0)

When the multiturn limit set value is changed with parameter Pn205, a multiturn limit disagreement alarm (A.CC0) will be displayed because the value differs from that of the encoder.

Alarm Display	Alarm Name	Alarm Code Output			Meaning
A.CC0	Multiturn Limit Disagreement	ALO1	ALO2	ALO3	Different multiturn limits have been set in the encoder and SERVOPACK.
		ON (L)	OFF (H)	ON (L)	

If this alarm is displayed, perform the operation described below and change the multiturn limit value in the encoder to the value set in Pn205.

Step	Display after Operation	Keys	Operation
1			Press the MODE/SET Key to select the utility function.
2			Press the UP or DOWN Key to select Fn013.
3			Press the DATA/SHIFT Key for approximately one second. "PGSEt" appears.
4			Press the MODE/SET Key. The value of the multiturn limit setting in the absolute encoder will be the same as the value of Pn205. When the setting is completed, "donE" flashes for approximately one second.
5			Then, "donE" changes to "PGSEt".
6			Press the DATA/SHIFT Key for approximately one second. "Fn013" is displayed again.
7	To enable the change in the setting, turn the power OFF and ON again.		

5.10 Other Output Signals

This section explains other output signals.

Use these signals according to the application needs, e.g., for machine protection.

5.10.1 Servo Alarm Output Signal (ALM) and Alarm Code Output Signals (ALO1, ALO2, and ALO3)

This section describes signals that are output when the SERVOPACK detects errors and resetting methods.

(1) Servo Alarm Output Signal (ALM)

This signal is output when the SERVOPACK detects an error.

 IMPORTANT	Configure an external circuit so that this alarm output turns OFF the main circuit power supply for the SERVOPACK whenever an error occurs.
---	---

Type	Signal Name	Connector Pin Number	Setting	Meaning
Output	ALM	CN1-31, 32	ON (closed)	Normal SERVOPACK status
			OFF (open)	SERVOPACK alarm status

(2) Alarm Code Output Signals (ALO1, ALO2, and ALO3)

The ON/OFF combination of these signals specifies the type of alarm detected by the SERVOPACK.

Use these signals as required to display the contents of the alarm at the host controller.

For details, refer to *10.1.1 List of Alarms*.

Type	Signal Name	Connector Pin Number	Meaning
Output	ALO1	CN1-37	Alarm code output
	ALO2	CN1-38	Alarm code output
	ALO3	CN1-39	Alarm code output
	SG	CN1-1	Signal ground for alarm code output

(3) Alarm Reset Method

If a servo alarm (ALM) occurs, use one of the following methods to reset the alarm after eliminating the cause of the alarm.

The /ALM-RST signal will not always reset encoder-related alarms. If an alarm cannot be reset with /ALM-RST, cycle the control power supply.

 IMPORTANT	<p>Be sure to eliminate the cause of the alarm before resetting it.</p> <p>If the alarm is reset and operation continued without eliminating the cause of the alarm, it may result in damage to the equipment or fire.</p>
---	--

■ Resetting Alarms by Turning ON the /ALM-RST Signal

Type	Signal Name	Connector Pin Number	Meaning
Input	/ALM-RST	CN1-44	Alarm reset

■ Resetting Alarms Using the Panel Operator

Simultaneously press the UP and the DOWN Keys on the panel operator. For details, refer to *2.1.1 Names and Functions*.

■ Resetting Alarms Using the Digital Operator

Press the ALARM RESET Key on the digital operator. For details, refer to *ΣV Series User's Manual, Operation of Digital Operator* (No.: SIEP S800000 55).

5.10.2 Warning Output Signal (/WARN)

This signal is for a warning issued before the occurrence of an alarm.
Refer to *10.2.1 List of Warnings*.

(1) Signal Specifications

Type	Signal Name	Connector Pin Number	Setting	Meaning
Output	/WARN	Must be allocated	ON (closed)	Warning status
			OFF (open)	Normal status

Note: Use parameter Pn50F.3 to allocate the /WARN signal for use. For details, refer to *3.3.2 Output Signal Allocations*.

(2) Related Parameters

Set the output method for alarm codes in Pn001.3.

For details on alarm codes, refer to *(2) Alarm Code Output Signals (ALO1, ALO2, and ALO3)* of *5.10.1 Servo Alarm Output Signal (ALM) and Alarm Code Output Signals (ALO1, ALO2, and ALO3)*.

Parameter	Meaning	When Enabled	Classification
Pn001	n.0□□□	After restart	Setup
	n.1□□□		

For details on warning codes, refer to *10.2.1 List of Warnings*.

5.10.3 Rotation Detection Output Signal (/TGON)

This output signal indicates that the servomotor is rotating at the speed set for Pn502 or a higher speed.

(1) Signal Specifications

Type	Signal Name	Connector Pin Number	Setting	Meaning
Output	/TGON	CN1-27, 28 [Factory setting]	ON (closed)	Servomotor is rotating with the motor speed above the setting in Pn502.
			OFF (open)	Servomotor is rotating with the motor speed below the setting in Pn502.

Note: Use parameter Pn50E.2 to allocate the /TGON signal to another terminal. For details, refer to 3.3.2 *Output Signal Allocations*.

(2) Related Parameter

Set the range in which the /TGON signal is output using the following parameter.

Pn502	Rotation Detection Level				Classification
	Setting Range	Setting Unit	Factory Setting	When Enabled	
	1 to 10000	1 min ⁻¹	20	Immediately	

5.10.4 Servo Ready Output Signal (/S-RDY)

This signal is turned ON when the SERVOPACK is ready to accept the servo ON signal (/S-ON).

The /S-RDY signal is turned ON under the following conditions.

- The main circuit power supply is ON.
- No hard wire base block state
- No servo alarms
- The SEN signal is ON at a high level. (When an absolute encoder is used.)

If an absolute encoder is used, the output of absolute data to the host controller must have been completed when the SEN signal is ON (high level) before /S-RDY is output.

For details on the hard wire base block function, refer to 5.11.1 *Hard Wire Base Block (HWBB) Function*.

(1) Signal Specifications

Type	Signal Name	Connector Pin Number	Setting	Meaning
Output	/S-RDY	CN1-29, 30 [Factory setting]	ON (closed)	The SERVOPACK is ready to accept the servo ON signal.
			OFF (open)	The SERVOPACK is not ready to accept the servo ON signal.

Note 1. Use parameter Pn50E.3 to allocate the /S-RDY signal to another terminal. For details, refer to 3.3.2 *Output Signal Allocations*.

2. For details on the hard wire base block function and the servo ready output signal, refer to 5.11.1 *Hard Wire Base Block (HWBB) Function*.

5.11 Safety Function

The safety function is incorporated in the SERVOPACK to reduce the risk associated with the machine by protecting workers from injury and by securing safe machine operation. Especially when working in hazardous areas inside the safeguard, as for machine maintenance, it can be used to avoid adverse machine movement.

5.11.1 Hard Wire Base Block (HWBB) Function

The Hard Wire Base Block function (hereinafter referred to as HWBB function) is a safety function designed to baseblock the servomotor (shut off the motor current) by using the hardwired circuits. Each circuit for two channel input signals blocks the run signal to turn off the power module that controls the motor current, and the motor current is shut off. (Refer to the diagram below.)

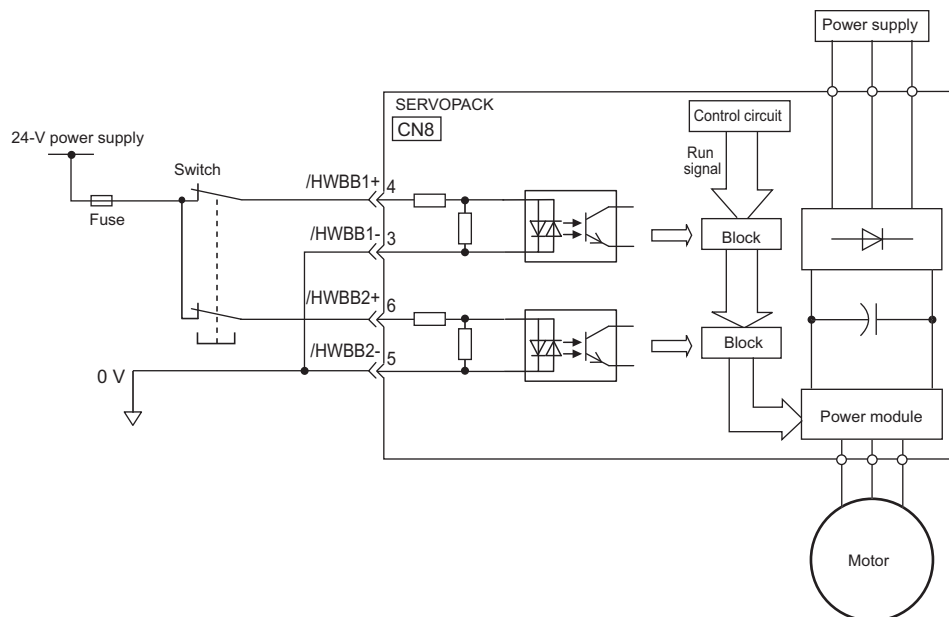

IMPORTANT

For safety function signal connections, the input signal is the 0 V common and the output signal is the source output. This is the opposite of other signals described in this manual. To avoid confusion, the ON and OFF status of signals for safety functions are defined as follows:

ON: The state in which the relay contacts are closed or the transistor is ON and current flows into the signal line.

OFF: The state in which the relay contacts are open or the transistor is OFF and no current flows into the signal line.

(1) Risk Assessment

When using the HWBB function, be sure to perform a risk assessment of the servo system in advance. Make sure that the safety level of the standards is met. For details about the standards, refer to *Harmonized Standards* at the front of this manual.

Note: To meet the performance level d (PLd) in EN ISO 13849-1, the EDM signal must be monitored by a host controller. If the EDM signal is not monitored by a host controller, the system only qualifies for the performance level c (PLc).

The following risks can be estimated even if the HWBB function is used. These risks must be included in the risk assessment.

- The servomotor will move in an application where external force is applied to the servomotor (for example, gravity on the vertical axis). Take measures to secure the servomotor, such as installing a mechanical brake.
- The servomotor may move within the electric angle of 180 degrees in case of the power module failure, etc. Make sure that safety is ensured even in that situation. The rotation angle depends on the motor type. The maximum rotation angle is given below.
 - Rotational motor: 1/6 rotation max. (rotation angle at the motor shaft)
 - Direct drive motor: 1/20 rotation max. (rotation angle at the motor shaft)
- The HWBB function does not shut off the power to the SERVOPACK or electrically isolate it. Take measures to shut off the power to the SERVOPACK when performing maintenance on it.

(2) Hard Wire Base Block (HWBB) State

The SERVOPACK will be in the following state if the HWBB function operates. If the /HWBB1 or /HWBB2 signal is OFF, the HWBB function will operate and the SERVOPACK will enter a hard wire baseblock (HWBB) state.

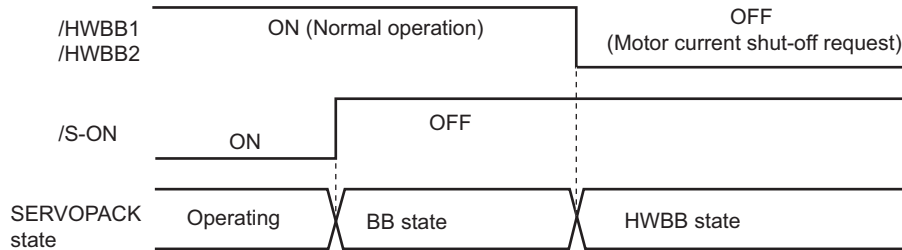

(3) Resetting the HWBB State

Usually after the servo ON signal (/S-ON) is turned OFF, the SERVOPACK will then enter a hard wire baseblock (HWBB) state with the /HWBB1 and /HWBB2 signals turned OFF. By then turning the /HWBB1 and /HWBB2 signals ON in this state, the SERVOPACK will enter a baseblock (BB) state and can accept the servo ON signal.

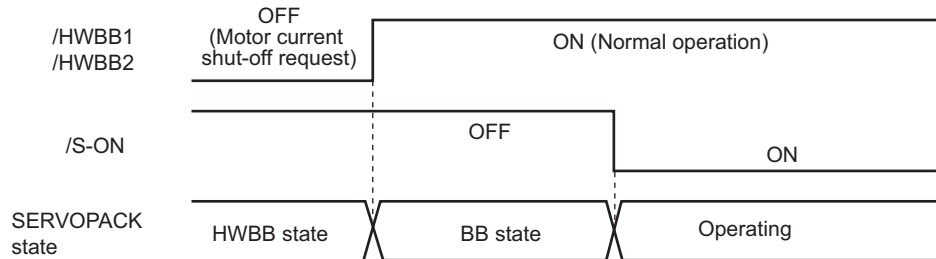

If the /HWBB1 and /HWBB2 signals are OFF and the servo ON signal is ON, the HWBB state will be maintained after the /HWBB1 and /HWBB2 signals are turned ON.

Turn OFF the servo ON signal, and the SERVOPACK is placed in a BB state. Then turn ON the servo ON signal again.

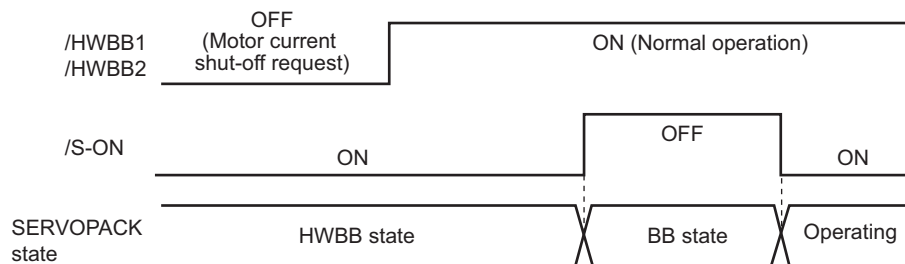

Note 1. If the SERVOPACK is placed in a BB state with the main power supply turned OFF, the HWBB state will be maintained until the servo ON signal is turned OFF.

2. The HWBB state cannot be reset if the servo ON signal is set to be constantly enabled in the servo ON signal allocation (Pn50A.1). Do not make this setting if the HWBB function is being used.

(4) Error Detection in HWBB Signal

If only the /HWBB1 or /HWBB2 signal is input, an A.Eb1 alarm (Safety Function Signal Input Timing Error) will occur unless the other signal is input within 10 seconds. This makes it possible to detect failures, such as disconnection of the HWBB signals.

CAUTION

- The safety function signal input timing error alarm (A.Eb1) is not a safety-related part of a control system. Keep this in mind in the system design.

(5) Connection Example and Specifications of Input Signals (HWBB Signals)

The input signals must be redundant. A connection example and specifications of input signals (HWBB signals) are shown below.



IMPORTANT

For safety function signal connections, the input signal is the 0 V common and the output signal is the source output. This is opposite to other signals described in this manual. To avoid confusion, the ON and OFF status of signals for safety functions are defined as follows:

ON: The state in which the relay contacts are closed or the transistor is ON and current flows into the signal line.

OFF: The state in which the relay contacts are open or the transistor is OFF and no current flows into the signal line.

■ Connection Example

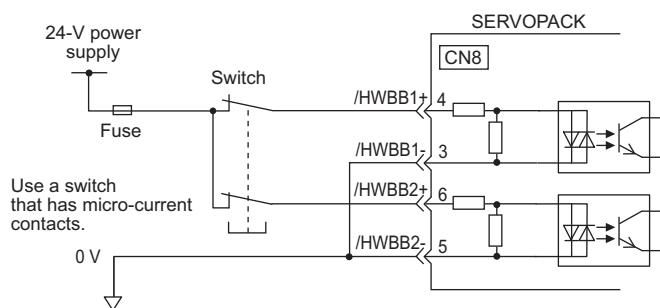

■ Specifications

Type	Signal Name	Connector Pin Number	Setting	Meaning
Input	/HWBB1	CN8-4 CN8-3	ON (closed)	Does not use the HWBB function. (normal operation)
			OFF (open)	Uses the HWBB function. (motor current shut-off request)
	/HWBB2	CN8-6 CN8-5	ON (closed)	Does not use the HWBB function. (normal operation)
			OFF (open)	Uses the HWBB function. (motor current shut-off request)

The input signals (HWBB signals) have the following electrical characteristics.

Items	Characteristics	Remarks
Internal Impedance	3.3 kΩ	—
Operation Movable Voltage Range	+11 V to + 25 V	—
Maximum Delay Time	20 ms	Time from the /HWBB1 and /HWBB2 signals are OFF to the HWBB function operates.

If the HWBB function is requested by turning OFF the /HWBB1 and /HWBB2 input signals on the two channels, the power supply to the servomotor will be turned OFF within 20 ms (see below).

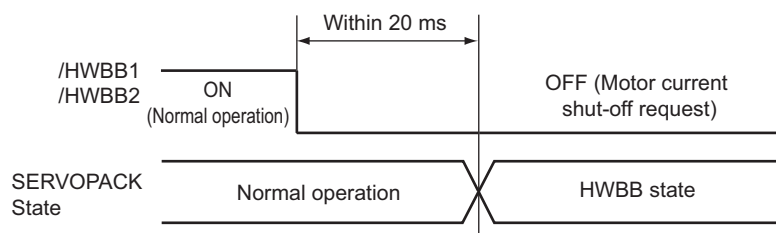

Note 1. The OFF status is not recognized if the total OFF time of the /HWBB1 and /HWBB2 signals is 0.5 ms or shorter.
 2. The status of the input signals can be checked using monitor displays. Refer to 8.6 Monitoring Safety Input Signals.

(6) Operation with Utility Functions

The HWBB function works while the SERVOPACK operates in the utility function.

If any of the following utility functions is being used with the /HWBB1 and /HWBB2 signals turned OFF, the SERVOPACK cannot be operated by turning ON the /HWBB1 and /HWBB2 signals. Cancel the utility function first, and then set the SERVOPACK to the utility function again and restart operation.

- JOG operation (Fn002)
- Origin search (Fn003)
- Program JOG operation (Fn004)
- Advanced autotuning (Fn201)
- EasyFFT (Fn206)
- Automatic offset-signal adjustment of motor current detection signal (Fn00E)

(7) Servo Ready Output (/S-RDY)

The servo ON (/S-ON) signal will not be accepted in the HWBB state. Therefore, the servo ready output will turn OFF. The servo ready output will turn ON if the servo ON signal is turned OFF (set to BB state) when both the /HWBB1 and /HWBB2 signals are ON.

The following diagram shows an example where the main circuit power supply is turned ON, the SEN signal is turned ON (with an absolute encoder), and no servo alarm occurs.

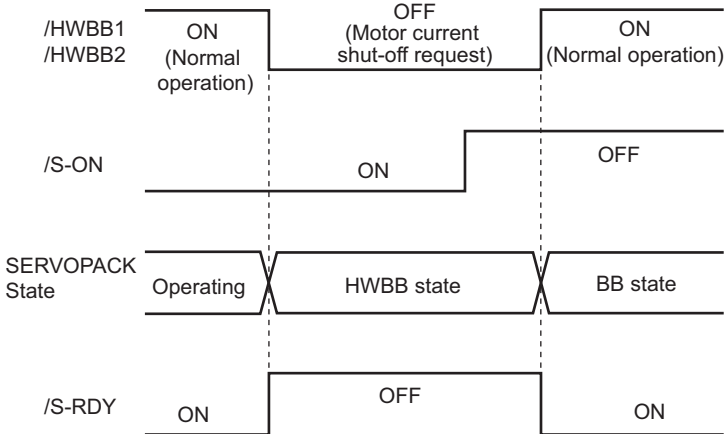

(8) Brake Signal (/BK)

When the /HWBB1 or /HWBB2 signal is OFF and the HWBB function operates, the brake signal (/BK) will turn OFF. At that time, Pn506 (brake reference - servo OFF delay time) will be disabled. Therefore, the servomotor may be moved by external force until the actual brake becomes effective after the brake signal (/BK) turns OFF.

⚠ CAUTION

- The brake signal is not a safety-related part of a control system. Be sure to design the system so that the system will not be put into danger if the brake signal fails in the HWBB state. Moreover, if a servomotor with a brake is used, keep in mind that the brake for the servomotor is used only to prevent the movable part from being moved by gravity or an external force and it cannot be used to brake the servomotor.

(9) Dynamic Brake

If the dynamic brake is enabled in Pn001.0 (Stopping Method for Servomotor after /S-ON Signal is Turned OFF), the servomotor will come to a stop under the control of the dynamic brake when the HWBB function works while the /HWBB1 or /HWBB2 signal is OFF.



CAUTION

- The dynamic brake is not a safety-related part of a control system. Be sure to design the system so that the system will not be put into danger if the servomotor coasts to a stop in the HWBB state. Usually, use a sequence in which the HWBB state occurs after the servomotor is stopped using the reference.
- If the application frequently uses the HWBB function, do not use the dynamic brake to stop the servomotor. Otherwise element deterioration in the SERVOPACK may result. To prevent internal elements from deteriorating, use a sequence in which the HWBB state occurs after the servomotor has come to a stop.

(10) Position Error Clear Setting

A position error in the HWBB state is cleared according to the setting in Pn200.2 for the clear operation selection.

If Pn200.2 is set to 1 (i.e., the position error is not cleared for position control), the position errors will be accumulated unless the position reference from the host controller is canceled in the HWBB state, and the following conditions may result.

- A position error overflow alarm (A.d00) occurs.
- If the servo is turned ON after changing from HWBB state to BB state, the servomotor will move for the accumulated position error.

Therefore, stop the position reference through the host controller while in HWBB state. If Pn200.2 is set to 1 (i.e., the position error is not cleared), input the clear (CLR) signal while in HWBB or BB state to clear the position error.

(11) Servo Alarm Output Signal (ALM) and Alarm Code Output Signals (ALO1, ALO2, and ALO3)

In the HWBB state, the servo alarm output signal (ALM) and alarm code output signals (AOL1, AOL2, and AOL3) are not sent.

5.11.2 External Device Monitor (EDM1)

The external device monitor (EDM1) functions to monitor failures in the HWBB function. Connect the monitor to feedback signals to the safety function device.

Note: To meet the performance level d (PLd) in EN ISO13849-1, the EDM signal must be monitored by a host controller. If the EDM signal is not monitored by a host controller, the system only qualifies for the performance level c (PLc).

■ Failure Detection Signal for EDM1 Signal

The relation of the EDM1, /HWBB1, and /HWBB2 signals is shown below.

Detection of failures in the EDM1 circuit can be checked using the following four status of the EDM1 signal in the table. Failures can be detected if the failure status can be confirmed, e.g., when the power supply is turned ON.

Signal Name	Logic			
/HWBB1	ON	ON	OFF	OFF
/HWBB2	ON	OFF	ON	OFF
EDM1	OFF	OFF	OFF	ON



WARNING

- The EDM1 signal is not a safety output. Use it only for monitoring a failure.

(1) Connection Example and Specifications of EDM1 Output Signal

Connection example and specifications of EDM1 output signal are explained below.



IMPORTANT

For safety function signal connections, the input signal is the 0 V common and the output signal is the source output. This is opposite to other signals described in this manual. To avoid confusion, the ON and OFF status of signals for safety functions are defined as follows:

ON: The state in which the relay contacts are closed or the transistor is ON and current flows into the signal line.

OFF: The state in which the relay contacts are open or the transistor is OFF and no current flows into the signal line.

■ Connection Example

EDM1 output signal is used for source circuit.

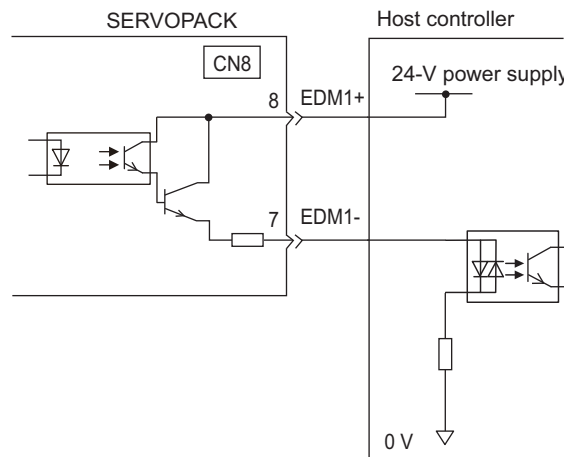

■ Specifications

Type	Signal Name	Connector Pin Number	Setting	Meaning
Output	EDM1	CN8-8 CN8-7	ON (closed)	Both the /HWBB1 and the /HWBB2 signals are working normally.
			OFF (open)	The /HWBB1 signal, the /HWBB2 signal or both are not working normally.

Electrical characteristics of EDM1 signal are as follows.

Items	Characteristics	Remarks
Maximum Allowable Voltage	30 VDC	—
Maximum Current	50 mADC	—
Maximum Voltage Drop at ON	1.0 V	Voltage between EDM1+ and EDM1- when current is 50 mA
Maximum Delay Time	20 ms	Time from the change in /HWBB1 or /HWBB2 until the change in EDM1

5.11.3 Application Example of Safety Functions

An example of using safety functions is shown below.

(1) Connection Example

In the following example, a safety unit is used and the HWBB function operates when the guard opens.

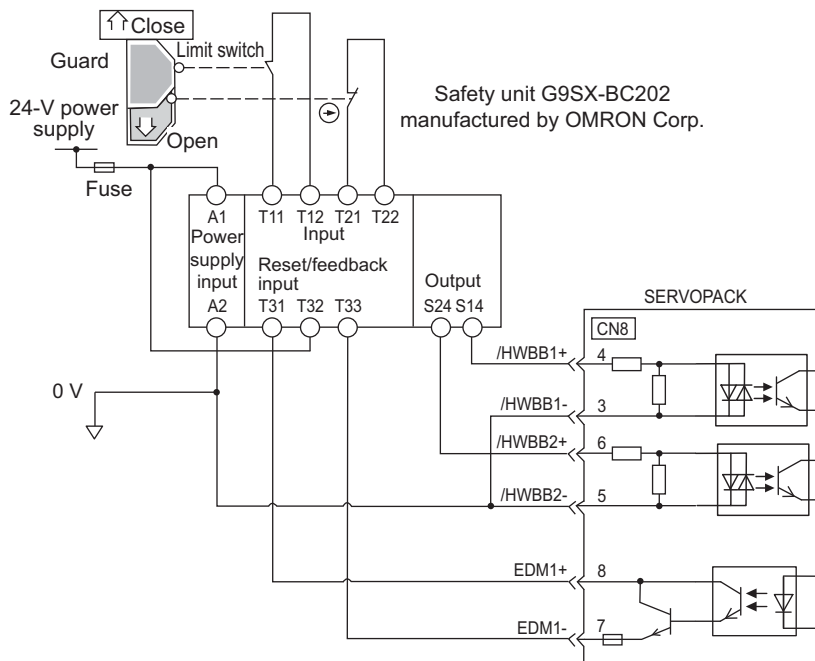

When a guard opens, both of signals, the /HWBB1 and the /HWBB2, turn OFF, and the EDM1 signal turns ON. Since the feedback is ON when the guard closes, the safety unit is reset, and the /HWBB1 and the /HWBB2 signals turn ON, and the operation becomes possible.

Note: The EDM1 signal is used as a sourcing output. Connect the EDM1 so that the current flows from EMD1+ to EMD1-.

(2) Failure Detection Method

In case of a failure such as the /HWBB1 or the /HWBB2 signal remains ON, the safety unit is not reset when the guard closes because the EDM1 signal keeps OFF. Therefore starting is impossible, then the failure is detected.

In this case, an error in the external device, disconnection or short-circuiting of the external wiring, or a failure in the SERVOPACK must be considered. Find the cause and correct the problem.

(3) Procedure

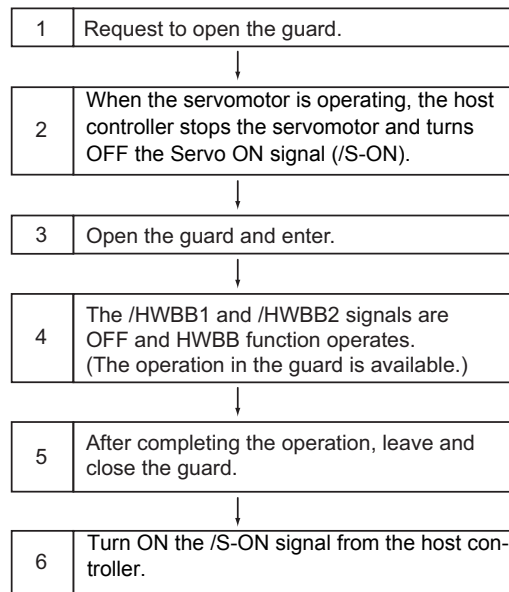

5.11.4 Confirming Safety Functions

When starting the equipment or replacing the SERVOPACK for maintenance, be sure to conduct the following confirmation test on the HWBB function after wiring.

- Confirm that the SERVOPACK enters a hard wire base block state and that the servomotor does not operate when the /HWBB1 and /HWBB2 signals are OFF.
- Check the ON/OFF states of the /HWBB1 and /HWBB2 signals with Un015.
→ If the ON/OFF states of the signals do not coincide with the display, an error in the external device, disconnection or short-circuiting of the external wiring, or a failure in the SERVOPACK must be considered. Find the cause and correct the problem. For details, refer to 8.7 *Monitor Display at Power ON*.
- Check with the display of the feedback circuit input of the connected device to confirm that the EDM1 signal is OFF while in normal operation.

5.11.5 Precautions for Safety Functions

WARNING

- To check that the HWBB function satisfies the safety requirements of the system, be sure to conduct a risk assessment of the system.
Incorrect use of the machine may cause injury.
- The servomotor rotates if there is external force (e.g., gravity in a vertical axis) when the HWBB function is operating. Therefore, use an appropriate device independently, such as a mechanical brake, that satisfies safety requirements.
Incorrect use of the machine may cause injury.
- While the HWBB function is operating, the motor may rotate within an electric angle of 180° or less as a result of a SERVOPACK failure. Use the HWBB function for applications only after checking that the rotation of the motor will not result in a dangerous condition.
Incorrect use of the machine may cause injury.
- The dynamic brake and the brake signal are not safety-related parts of a control system. Be sure to design the system that these failures will not cause a dangerous condition when the HWBB function operates.
Incorrect use of the machine may cause injury.
- Connect devices meeting safety standards for the signals for safety functions.
Incorrect use of the machine may cause injury.
- If the HWBB function is used for an emergency stop, turn OFF the power supply to the servomotor with independent electric or mechanical parts.
Incorrect use of the machine may cause injury.
- The HWBB function does not shut off the power to the SERVOPACK or electrically isolate it. Take measures to shut off the power to the SERVOPACK when performing maintenance on it.
Failure to observe this warning may cause an electric shock.

Adjustments

6.1	Type of Adjustments and Basic Adjustment Procedure	6-3
6.1.1	Adjustments	6-3
6.1.2	Basic Adjustment Procedure	6-5
6.1.3	Monitoring Operation during Adjustment	6-6
6.1.4	Safety Precautions on Adjustment of Servo Gains	6-9
6.2	Tuning-less Function	6-12
6.2.1	Tuning-less Function	6-12
6.2.2	Tuning-less Levels Setting (Fn200) Procedure	6-15
6.2.3	Related Parameters	6-18
6.3	Advanced Autotuning (Fn201)	6-19
6.3.1	Advanced Autotuning	6-19
6.3.2	Advanced Autotuning Procedure	6-22
6.3.3	Related Parameters	6-28
6.4	Advanced Autotuning by Reference (Fn202)	6-29
6.4.1	Advanced Autotuning by Reference	6-29
6.4.2	Advanced Autotuning by Reference Procedure	6-32
6.4.3	Related Parameters	6-36
6.5	One-parameter Tuning (Fn203)	6-37
6.5.1	One-parameter Tuning	6-37
6.5.2	One-parameter Tuning Procedure	6-39
6.5.3	One-parameter Tuning Example	6-46
6.5.4	Related Parameters	6-47
6.6	Anti-Resonance Control Adjustment Function (Fn204)	6-48
6.6.1	Anti-Resonance Control Adjustment Function	6-48
6.6.2	Anti-Resonance Control Adjustment Function Operating Procedure	6-49
6.6.3	Related Parameters	6-53
6.7	Vibration Suppression Function (Fn205)	6-54
6.7.1	Vibration Suppression Function	6-54
6.7.2	Vibration Suppression Function Operating Procedure	6-55
6.7.3	Related Parameters	6-58

6.8 Additional Adjustment Function	6-59
6.8.1 Switching Gain Settings	6-59
6.8.2 Manual Adjustment of Friction Compensation	6-63
6.8.3 Current Control Mode Selection Function	6-65
6.8.4 Current Gain Level Setting	6-65
6.8.5 Speed Detection Method Selection	6-65
6.9 Compatible Adjustment Function	6-66
6.9.1 Feedforward Reference	6-66
6.9.2 Torque Feedforward	6-66
6.9.3 Speed Feedforward	6-68
6.9.4 Proportional Control	6-69
6.9.5 Mode Switch (P/PI Switching)	6-70
6.9.6 Torque Reference Filter	6-72
6.9.7 Position Integral	6-74

6.1 Type of Adjustments and Basic Adjustment Procedure

This section describes type of adjustments and the basic adjustment procedure.

6.1.1 Adjustments

Adjustments (tuning) are performed to optimize the responsiveness of the SERVOPACK.

The responsiveness is determined by the servo gain that is set in the SERVOPACK.

The servo gain is set using a combination of parameters, such as speed loop gain, position loop gain, filters, friction compensation, and moment of inertia ratio. These parameters influence each other. Therefore, the servo gain must be set considering the balance between the set values.

Generally, the responsiveness of a machine with high rigidity can be improved by increasing the servo gain. If the servo gain of a machine with low rigidity is increased, however, the machine will vibrate and the responsiveness may not be improved. In such case, it is possible to suppress the vibration with a variety of vibration suppression functions in the SERVOPACK.

The servo gains are factory-set to appropriate values for stable operation. The following utility function can be used to adjust the servo gain to increase the responsiveness of the machine in accordance with the actual conditions. With this function, parameters related to adjustment above will be adjusted automatically and the need to adjust them individually will be eliminated.

This section describes the following utility adjustment functions.

Utility Function for Adjustment	Outline	Applicable Control Method	Tool*		
			Digital Operator	Panel Operator	SigmaWin+
Tuning-less Levels Setting (Fn200)	This function is enabled when the factory settings are used. This function can be used to obtain a stable response regardless of the type of machine or changes in the load.	Speed and Position	○	○	○
Advanced Autotuning (Fn201)	The following parameters are automatically adjusted using internal references in the SERVOPACK during automatic operation. <ul style="list-style-type: none"> • Moment of inertia ratio • Gains (position loop gain, speed loop gain, etc.) • Filters (torque reference filter, notch filter) • Friction compensation • Anti-resonance control adjustment function • Vibration suppression function 	Speed and Position	○	×	○
Advanced Autotuning by Reference (Fn202)	The following parameters are automatically adjusted with the position reference input from the host controller while the machine is in operation. <ul style="list-style-type: none"> • Gains (position loop gain, speed loop gain, etc.) • Filters (torque reference filter, notch filter) • Friction compensation • Anti-resonance control adjustment function • Vibration suppression function 	Position	○	×	○
One-parameter Tuning (Fn203)	The following parameters are manually adjusted with the position or speed reference input from the host controller while the machine is in operation. <ul style="list-style-type: none"> • Gains (position loop gain, speed loop gain, etc.) • Filters (torque reference filter, notch filter) • Friction compensation • Anti-resonance control adjustment function 	Speed and Position	○	△	○

* ○: Available

△: Can be used but functions are limited.

×: Not available

6 Adjustments

6.1.1 Adjustments

(cont'd)

Utility Function for Adjustment	Outline	Applicable Control Method	Tool*		
			Digital Operator	Panel Operator	SigmaWin+
Anti-Resonance Control Adjustment Function (Fn204)	This function effectively suppresses continuous vibration.	Speed and Position	○	×	○
Vibration Suppression Function (Fn205)	This function effectively suppresses residual vibration if it occurs when positioning.	Position	○	×	○

- * ○: Available
- △: Can be used but functions are limited.
- ×: Not available

6.1.2 Basic Adjustment Procedure

The basic adjustment procedure is shown in the following flowchart. Make suitable adjustments considering the conditions and operating requirements of the machine.

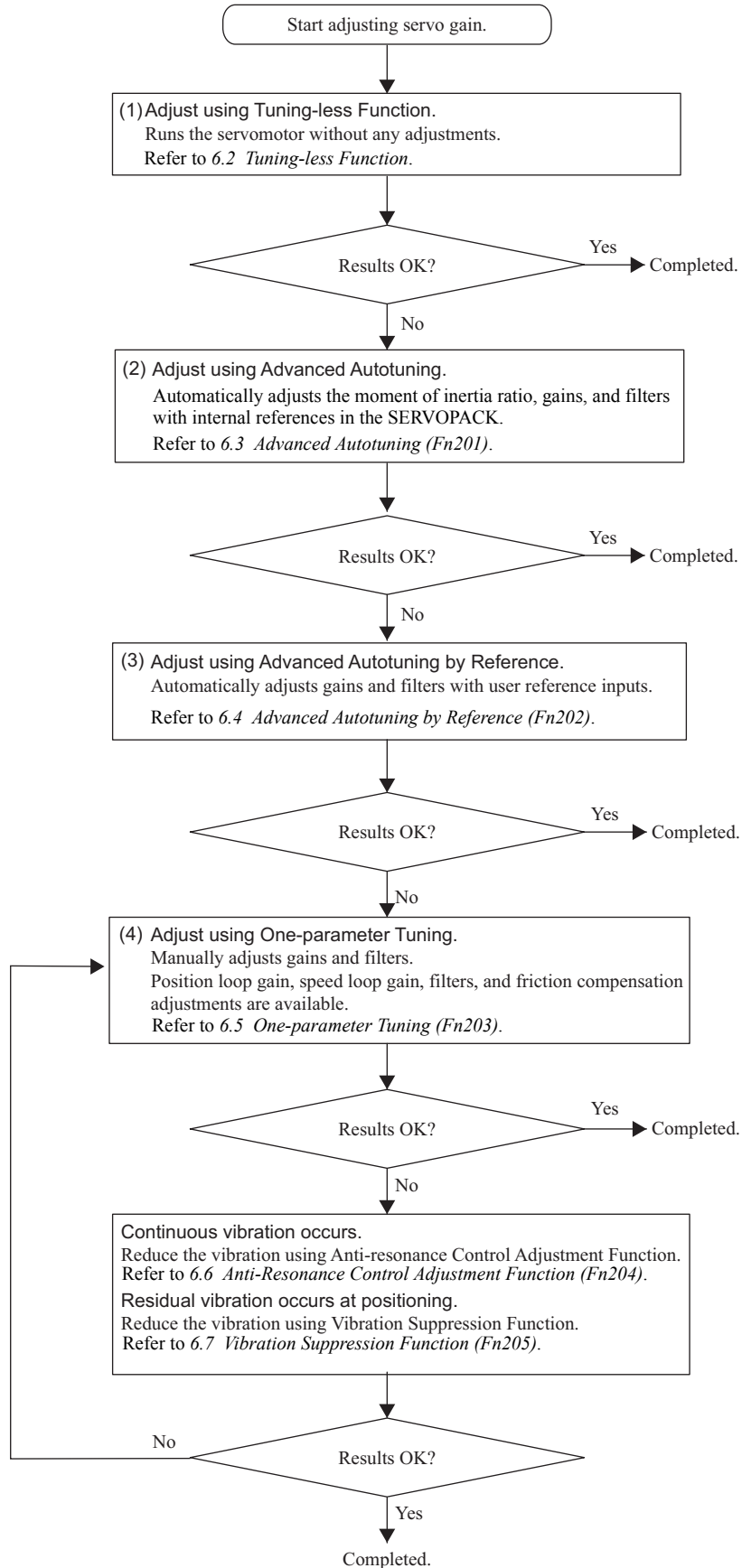

6.1.3 Monitoring Operation during Adjustment

Check the operating status of the machine and signal waveform when adjusting the servo gain. Connect a measuring instrument, such as a memory recorder, to connector CN5 analog monitor connector on the SERVO-PACK to monitor analog signal waveform.

The settings and parameters for monitoring analog signals are described in the following sections.

(1) Connector CN5 for Analog Monitor

To monitor analog signals, connect a measuring instrument with cable (JZSP-CA01-E) to the connector CN5.

■ Connection Example

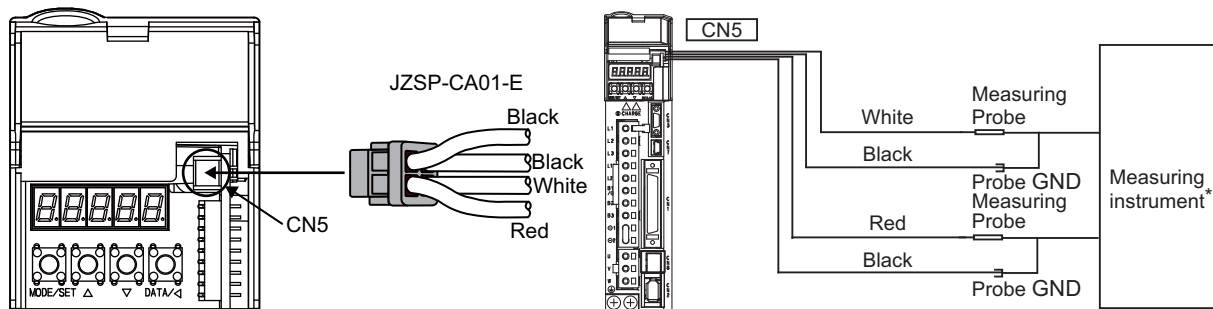

* Measuring instrument is not included.

Line Color	Signal Name	Factory Setting
White	Analog monitor 1	Torque reference: 1 V/100% rated torque
Red	Analog monitor 2	Motor speed: 1 V/1000 min ⁻¹
Black (2 lines)	GND	Analog monitor GND: 0 V

(2) Monitor Signal

The shaded parts in the following diagram indicate analog output signals that can be monitored.

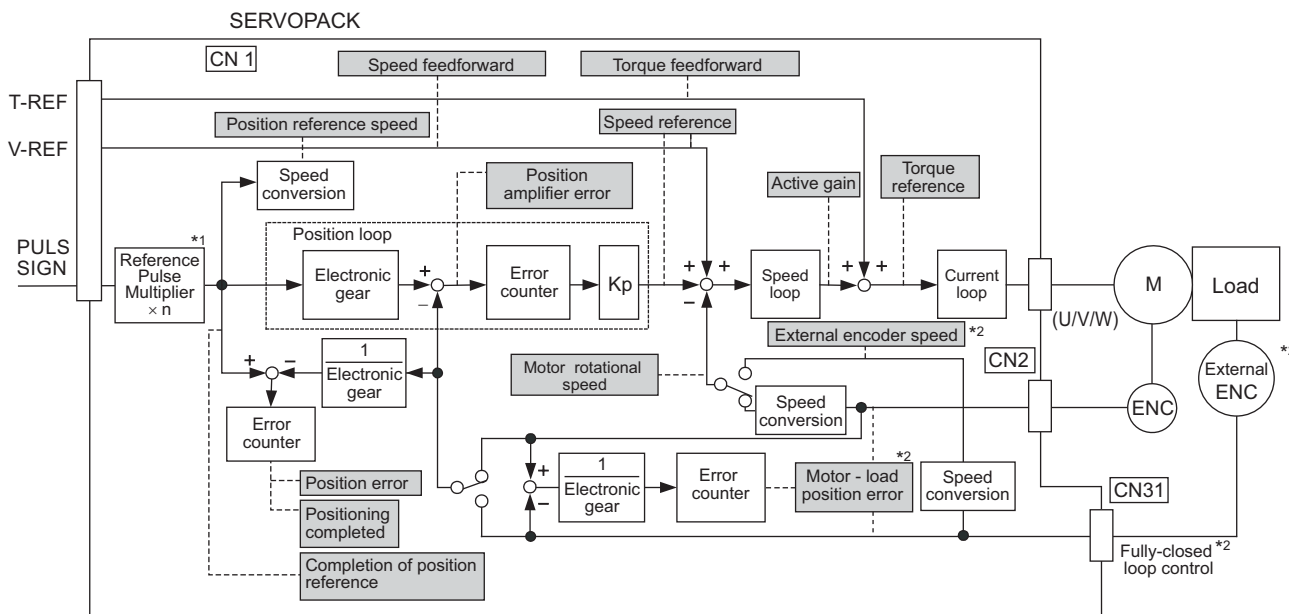

*1. The reference pulse input multiplication switching function is supported by software version 001A or later.

*2. Available when the fully-closed loop control is being used.

The following signals can be monitored by selecting functions with parameters Pn006 and Pn007. Pn006 is used for analog monitor 1 and Pn007 is used for analog monitor 2.

Parameter		Description		
		Monitor Signal	Unit	Remarks
Pn006 Pn007	n.□□00 [Pn007 Factory Setting]	Motor rotating speed	1 V/1000 min ⁻¹	–
	n.□□01	Speed reference	1 V/1000 min ⁻¹	–
	n.□□02 [Pn006 Factory Setting]	Torque reference	1 V/100% rated torque	–
	n.□□03	Position error	0.05 V/1 reference unit	0 V at speed/torque control
	n.□□04	Position amplifier error	0.05 V/1 encoder pulse unit	Position error after electronic gear conversion
	n.□□05	Position reference speed	1 V/1000 min ⁻¹	The input reference pulses will be multiplied by n to output the position reference speed.
	n.□□06	Reserved (Do not change.)	–	–
	n.□□07	Motor-load position error	0.01 V/1 reference unit	–
	n.□□08	Positioning completed	Positioning completed: 5 V Positioning not completed: 0 V	Completion indicated by output voltage.
	n.□□09	Speed feedforward	1 V/1000 min ⁻¹	–
	n.□□0A	Torque feedforward	1 V/100% rated torque	–
	n.□□0B	Active gain *	1st gain: 1 V 2nd gain: 2 V	Gain type indicated by output voltage.
	n.□□0C	Completion of position reference	Completed: 5 V Not completed: 0 V	Completion indicated by output voltage.
	n.□□0D	External encoder speed	1 V/1000 min ⁻¹	Value at motor shaft

* Refer to 6.8.1 *Switching Gain Settings* for details.

(3) Setting Monitor Factor

The output voltages on analog monitors 1 and 2 are calculated by the following equations.

$$\begin{aligned} \text{Analog monitor 1 output voltage} &= (-1) \times \left(\begin{array}{l} \text{Signal selection} \times \text{Multiplier} + \text{Offset voltage [V]} \\ (\text{Pn006}=\text{n.00}\square\square) \quad (\text{Pn552}) \quad (\text{Pn550}) \end{array} \right) \\ \text{Analog monitor 2 output voltage} &= (-1) \times \left(\begin{array}{l} \text{Signal selection} \times \text{Multiplier} + \text{Offset voltage [V]} \\ (\text{Pn007}=\text{n.00}\square\square) \quad (\text{Pn553}) \quad (\text{Pn551}) \end{array} \right) \end{aligned}$$

<Example>

Analog monitor output at n.□□00 (motor rotating speed setting)

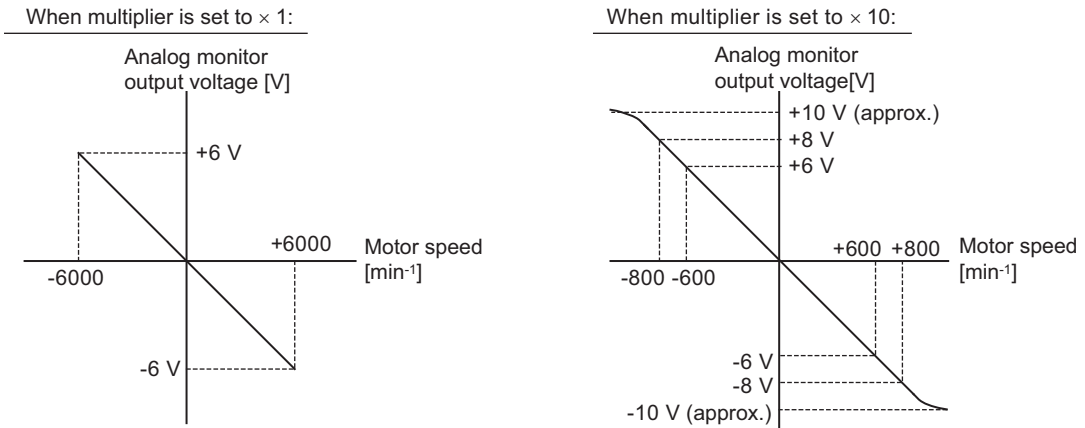

Note: Linear effective range: within ± 8 V
Output resolution: 16-bit

(4) Related Parameters

Use the following parameters to change the monitor factor and the offset.

Pn550	Analog Monitor 1 Offset Voltage Speed Position Torque				Classification
	Setting Range	Setting Unit	Factory Setting	When Enabled	
	-10000 to 10000	0.1 V	0	Immediately	Setup
Pn551	Analog Monitor 2 Offset Voltage Speed Position Torque				Classification
	Setting Range	Setting Unit	Factory Setting	When Enabled	
	-10000 to 10000	0.1 V	0	Immediately	Setup
Pn552	Analog Monitor Magnification (× 1) Speed Position Torque				Classification
	Setting Range	Setting Unit	Factory Setting	When Enabled	
	-10000 to 10000	× 0.01	100	Immediately	Setup
Pn553	Analog Monitor Magnification (× 2) Speed Position Torque				Classification
	Setting Range	Setting Unit	Factory Setting	When Enabled	
	-10000 to 10000	× 0.01	100	Immediately	Setup

6.1.4 Safety Precautions on Adjustment of Servo Gains

CAUTION

- If adjusting the servo gains, observe the following precautions.
 - Do not touch the rotating section of the servomotor while power is being supplied to the motor.
 - Before starting the servomotor, make sure that the SERVOPACK can come to an emergency stop at any time.
 - Make sure that a trial operation has been performed without any trouble.
 - Install a safety brake on the machine.

Set the following protective functions of the SERVOPACK to the correct settings before starting to adjust the servo gains.

(1) Overtravel Function

Set the overtravel function. For details on how to set the overtravel function, refer to 5.2.3 *Overtravel*.

(2) Torque Limit

The torque limit calculates the torque required to operate the machine and sets the torque limits so that the output torque will not be greater than required. Setting torque limits can reduce the amount of shock applied to the machine when troubles occur, such as collisions or interference. If a torque limit is set lower than the value that is needed for operation, overshooting or vibration can be occurred.

For details, refer to 5.8 *Limiting Torque*.

(3) Excessive Position Error Alarm Level

The excessive position error alarm is a protective function that will be enabled when the SERVOPACK is used in position control.

If this alarm level is set to a suitable value, the SERVOPACK will detect an excessive position error and will stop the servomotor if the servomotor does not operate according to the reference. The position error indicates the difference between the position reference value and the actual motor position.

The position error can be calculated from the position loop gain (Pn102) and the motor speed with the following equation.

$$\text{Position Error [reference unit]} = \frac{\text{Motor Speed [min}^{-1}\text{]}}{60} \times \frac{\text{Encoder Resolution}^{*1}}{\text{Pn102 [0.1/s]/10}^{*2}} \times \frac{\text{Pn210}}{\text{Pn20E}}$$

- Excessive Position Error Alarm Level (Pn520 [1 reference unit])

$$\text{Pn520} > \frac{\text{Max. Motor Speed [min}^{-1}\text{]}}{60} \times \frac{\text{Encoder Resolution}^{*1}}{\text{Pn102 [0.1/s]/10}^{*2}} \times \frac{\text{Pn210}}{\text{Pn20E}} \times \underline{(1.2 \text{ to } 2)}$$

*1. Refer to 5.4.4 *Electronic Gear*.

*2. To check the Pn102 setting, change the parameter display setting to display all parameters (Pn00B.0 = 1).

At the end of the equation, a coefficient is shown as "× (1.2 to 2)." This coefficient is used to add a margin that prevents a position error overflow alarm (A.d00) from occurring in actual operation of the servomotor.

Set the level to a value that satisfies these equations, and no position error overflow alarm (A.d00) will be generated during normal operation. The servomotor will be stopped, however, if it does not operate according to the reference and the SERVOPACK detects an excessive position error.

The following example outlines how the maximum limit for position deviation is calculated. These conditions apply.

- Maximum speed = 6000
- Encoder resolution = 1048576 (20 bits)
- Pn102 = 400
- $\frac{\text{Pn210}}{\text{Pn20E}} = \frac{1}{1}$

Under these conditions, the following equation is used to calculate the maximum limit (Pn520).

$$\begin{aligned} \text{Pn520} &= \frac{6000}{60} \times \frac{1048576}{400/10} \times \frac{1}{1} \times 2 \\ &= 2621440 \times 2 \\ &= 5242880 \text{ (The factory setting of Pn520)} \end{aligned}$$

If the acceleration/deceleration of the position reference exceeds the capacity of the servomotor, the servomotor cannot perform at the requested speed, and the allowable level for position error will be increased as not to satisfy these equations. If so, lower the level of the acceleration/deceleration for the position reference so that the servomotor can perform at the requested speed or increase the excessive position error alarm level (Pn520).

■ Related Parameter

Pn520	Excessive Position Error Alarm Level Position				Classification
	Setting Range	Setting Unit	Factory Setting	When Enabled	
	1 to 1073741823	1 reference unit	5242880	Immediately	Setup

■ Related Alarm

Alarm Display	Alarm Name	Meaning
A.d00	Position Error Overflow	Position errors exceeded parameter Pn520.

(4) Vibration Detection Function

Set the vibration detection function to an appropriate value with the vibration detection level initialization (Fn01B). For details on how to set the vibration detection function, refer to 7.16 *Vibration Detection Level Initialization (Fn01B)*.

(5) Excessive Position Error Alarm Level at Servo ON

If position errors remain in the error counter when turning ON the servomotor power, the servomotor will move and this movement will clear the counter of all position errors. Because the servomotor will move suddenly and unexpectedly, safety precautions are required. To prevent the servomotor from moving suddenly, select the appropriate level for the excessive position error alarm level at servo ON (Pn526) to restrict operation of the servomotor.

■ Related Parameters

Pn526	Excessive Position Error Alarm Level at Servo ON Position				Classification
	Setting Range	Setting Unit	Factory Setting	When Enabled	
	1 to 1073741823	1 reference unit	5242880	Immediately	Setup

Pn528	Excessive Position Error Warning Level at Servo ON Position				Classification
	Setting Range	Setting Unit	Factory Setting	When Enabled	
	10 to 100	1%	100	Immediately	Setup

Pn529	Speed Limit Level at Servo ON Position				Classification
	Setting Range	Setting Unit	Factory Setting	When Enabled	
	0 to 10000	1 min ⁻¹	10000	Immediately	Setup

■ Related Alarms

Alarm Display	Alarm Name	Meaning
A.d01	Position Error Overflow Alarm at Servo ON	This alarm occurs if the servomotor power is turned ON when the position error is greater than the set value of Pn526 while the servomotor power is OFF.
A.d02	Position Error Overflow Alarm by Speed Limit at Servo ON	When the position errors remain in the error counter, Pn529 limits the speed if the servomotor power is turned ON. If Pn529 limits the speed in such a state, this alarm occurs when reference pulses are input and the number of position errors exceeds the value set for the excessive position error alarm level (Pn520).

When an alarm occurs, refer to *10 Troubleshooting* and take the corrective actions.

6.2 Tuning-less Function

The tuning-less function is enabled in the factory settings. If resonance is generated or excessive vibration occurs, refer to 6.2.2 *Tuning-less Levels Setting (Fn200) Procedure* and change the set value of Pn170.2 for the rigidity level and the set value in Pn170.3 for the load level.

CAUTION

- The tuning-less function is enabled in the factory settings. A sound may be heard for a moment when the /S_ON signal is turned ON for the first time after the servo drive is mounted to the machine. This sound does not indicate any problems; it means that the automatic notch filter was set. The sound will not be heard from the next time the /S_ON signal is turned ON. For details on the automatic notch filter, refer to (3) *Automatically Setting the Notch Filter* on the next page.
- Set the mode to 2 in Fn200 if a 13-bit encoder is used with the moment of inertia ratio set to x10 or higher.
- The servomotor may vibrate if the load moment of inertia exceeds the allowable load value. If vibration occurs, set the mode to 2 in Fn200 or lower the adjustment level.

6.2.1 Tuning-less Function

The tuning-less function obtains a stable response without manual adjustment regardless of the type of machine or changes in the load.

(1) Enabling/Disabling Tuning-less Function

The following parameter is used to enable or disable the tuning-less function.

Parameter	Meaning	When Enabled	Classification
Pn170	n.□□□0	Disables tuning-less function.	After restart Setup
	n.□□□1 [Factory setting]	Enables tuning-less function.	
	n.□□0□ [Factory setting]	Used as speed control.	
	n.□□1□	Used as speed control and host controller used as position control.	

(2) Application Restrictions

The tuning-less function can be used in position control or speed control. This function is not available in torque control. The following application restrictions apply to the tuning-less function.

Function	Availability	Remarks
Vibration detection level initialization (Fn01B)	Available	–
Advanced autotuning (Fn201)	Available (Some conditions apply)	<ul style="list-style-type: none"> • This function can be used when the moment of inertia is calculated. • While this function is being used, the tuning-less function cannot be used. After completion of the autotuning, it can be used again.
Advanced autotuning by reference (Fn202)	Not available	–
One-parameter tuning (Fn203)	Not available	–
Anti-resonance control adjustment function (Fn204)	Not available	–
Vibration suppression function (Fn205)	Not available	–
EasyFFT (Fn206)	Available	While this function is being used, the tuning-less function cannot be used. After completion of the EasyFFT, it can be used again.
Friction compensation	Not available	–

(cont'd)

Function	Availability	Remarks
Gain switching	Not available	–
Offline moment of inertia calculation *	Not available	Disable the tuning-less function by setting Pn170.0 to 0 before executing this function.
Mechanical analysis*	Available	While this function is being used, the tuning-less function cannot be used. After completion of the analysis, it can be used again.

* Operate using SigmaWin+.

(3) Automatically Setting the Notch Filter

Usually, set this function to Auto Setting. (The notch filter is factory-set to Auto Setting.)

If this function is set to Auto Setting, vibration will be detected automatically and the notch filter will be set when the tuning-less function is enabled.

Set this function to Not Auto Setting only if you do not change the notch filter setting before executing tuning-less function.

Parameter	Meaning	When Enabled	Classification
Pn460	n.□0□□	Immediately	Tuning
	n.□1□□ [Factory setting]		

(4) Tuning-less Level Settings

Two tuning-less levels are available: the rigidity level and load level. Both levels can be set in the Fn200 utility function or in the Pn170 parameter.

■ Rigidity Level

a) Using the utility function

To change the setting, refer to 6.2.2 *Tuning-less Levels Setting (Fn200) Procedure*.

Digital Operator Display	Meaning
Level 0	Rigidity level 0
Level 1	Rigidity level 1
Level 2	Rigidity level 2
Level 3	Rigidity level 3
Level 4 [Factory setting]	Rigidity level 4

b) Using the parameter

Parameter	Meaning	When Enabled	Classification
Pn170	n.□0□□	Immediately	Setup
	n.□1□□		
	n.□2□□		
	n.□3□□		
	n.□4□□ [Factory setting]		

■ Load Level

a) Using the utility function

To change the setting, refer to 6.2.2 *Tuning-less Levels Setting (Fn200) Procedure*.

Digital Operator Display	Meaning
Mode 0	Load level : Low
Mode 1 [Factory setting]	Load level : Medium
Mode 2	Low level : High

b) Using the parameter

Parameter	Meaning	When Enabled	Classification	
Pn170	n.0□□□	Load level : Low (Mode 0)	Immediately	Setup
	n.1□□□ [Factory setting]	Load level : Medium (Mode 1)		
	n.2□□□	Low level : High (Mode 2)		

6.2.2 Tuning-less Levels Setting (Fn200) Procedure

⚠ CAUTION

- To ensure safety, perform the tuning-less function in a state where the SERVOPACK can come to an emergency stop at any time.

The procedure to use the tuning-less function is given below.

Operate the tuning-less function from the panel operator, digital operator (option), or SigmaWin+.





















For the basic operation of the digital operator, refer to *Σ-V Series User's Manual, Operation of Digital Operator* (No.: SIEP S800000 55).

(1) Preparation



Check the following settings before performing the tuning-less function. If the settings are not correct, "NO-OP" will be displayed during the tuning-less function.

- The tuning-less function must be enabled (Pn170.0 = 1).
- The write prohibited setting parameter (Fn010) must be set to Write permitted (P.0000).
- The test without a motor function must be disabled. (Pn00C.0 = 0).

(2) Operating Procedure with Digital Operator











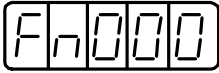

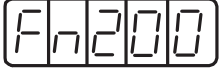
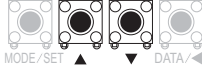
Step	Display after Operation	Keys	Operation
1	<pre> RUN -FUNCTION- Fn080: Pole Detect Fn200: TuneLvl Set Fn201: AAT Fn202: Ref-AAT </pre>	  	Press the  Key to view the main menu for the utility function. Use the  or  Key to move through the list, select Fn200.
2	<pre> RUN -TuneLvlSet- Mode=1 </pre>		Press the  Key to display the load level of the tuning-less mode setting screen. Notes: <ul style="list-style-type: none"> If the response waveform causes overshooting or if the load moment of inertia exceeds the allowable level (i.e., outside the scope of product guarantee), press the  Key and change the mode setting to 2. If a high-frequency noise is heard, press the  Key and change the mode setting to 0.
3	<pre> RUN -TuneLvlSet- Level=4 </pre>		Press the  Key to display the rigidity level of the tuning-less mode setting screen.
4	<pre> RUN -TuneLvlSet- Level=4 NF 2 </pre> <p style="text-align: center;">↑ 2nd notch filter</p>	  	Press the  Key or the  Key to select the rigidity level. Select the rigidity level from 0 to 4. The larger the value, the higher the gain is and the better response performance will be. (The factory setting is 4.) Notes: <ul style="list-style-type: none"> Vibration may occur if the rigidity level is too high. Lower the rigidity level if vibration occurs. If a high-frequency noise is heard, press the  Key to automatically set a notch filter to the vibration frequency.
5	<pre> RUN -TuneLvlSet- Level=4 </pre>		Press the  Key. "DONE" will flash for approximately two seconds and then "RUN" will be displayed. The settings are saved in the SERVOPACK.

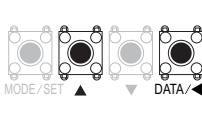
(cont'd)

Step	Display after Operation	Keys	Operation
6	<pre> RUN -FUNCTION- Fn030 Fn200 Fn201 Fn202 </pre>		Press the  Key to complete the tuning-less function. The screen in step 1 will appear again.

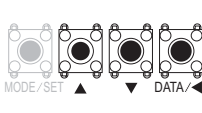
Note: If the rigidity level is changed, the automatically set notch filter will be canceled. If vibration occurs, however, the notch filter will be set again automatically.

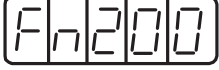
(3) Operating Procedure with Panel Operator

Step	Display after Operation	Keys	Operation
1			Press the MODE/SET Key to select the utility function.
2			Press the UP or the DOWN Key to select the Fn200.
3	 Load level		Press the DATA/SHIFT Key for approximately one second to display the load level of the tuning-less mode setting screen. Note: If the response waveform causes overshooting or if the load moment of inertia exceeds the allowable level (i.e., outside the scope of product guarantee), press the UP Key and change the load level to 2.
4			Press the MODE/SET Key to display the rigidity level of the tuning-less mode setting screen.
5	 Rigidity level		Press the UP or the DOWN Key to select the rigidity level. Select the rigidity level from 0 to 4. The larger the value, the higher the gain is and the better response performance will be. (The factory setting is 4.) Notes: • Vibration may occur if the rigidity level is too high. Lower the rigidity level if vibration occurs. • If high-frequency noise is generated, press the DATA/SHIFT Key to automatically set a notch filter to the vibration frequency.
6			Press the MODE/SET Key. "done" will flash for approximately one second and then L0004 will be displayed. The settings are saved in the SERVO-PACK.
7			Press the DATA/SHIFT Key for approximately one second. "Fn200" is displayed again.

(4) Alarm and Corrective Actions

The autotuning alarm (A.521) will occur if resonance sound is generated or excessive vibration occurs during position control. In such case, take the following actions.

■ Resonance Sound

Reduce the setting of the rigidity level or load level.

■ Excessive Vibration during Position Control

Take one of the following actions to correct the problem.

- Increase the setting of the rigidity level or reduce the load level.
- Increase the setting of Pn170.3 or reduce the setting of Pn170.2.

(5) Parameters Disabled by Tuning-less Function

When the tuning-less function is enabled in the factory settings, the settings of these parameters are not available: Pn100, Pn101, Pn102, Pn103, Pn104, Pn105, Pn106, Pn160, Pn139, and Pn408. These gain-related parameters, however, may become effective depending on the executing conditions of the functions specified in the following table. For example, if EasyFFT is executed when the tuning-less function is enabled, the settings in Pn100, Pn104, Pn101, Pn105, Pn102, Pn106, and Pn103, as well as the manual gain switch setting, will be enabled, but the settings in Pn408.3, Pn160.0, and Pn139.0 will be not enabled.

Parameters Disabled by Tuning-less Function			Related Functions and Parameters*		
Item	Name	Pn Number	Torque Control	Easy FFT	Mechanical Analysis (Vertical Axis Mode)
Gain	Speed Loop Gain 2nd Speed Loop Gain	Pn100 Pn104	○	○	○
	Speed Loop Integral Time Constant 2nd Speed Loop Integral Time Constant	Pn101 Pn105	×	○	○
	Position Loop Gain 2nd Position Loop Gain	Pn102 Pn106	×	○	○
	Moment of Inertia Ratio	Pn103	○	○	○
Advanced Control	Friction Compensation Function Selection	Pn408.3	×	×	×
	Anti-resonance Control Adjustment Selection	Pn160.0	×	×	×
Gain Switching	Gain Switching Selection Switch	Pn139.0	×	×	×

* ○: Parameter enabled

×: Parameter disabled

(6) Tuning-less Function Type

The following table shows the types of tuning-less functions for the version of SERVOPACK software.

Software Version*	Tuning-less Type	Meaning
000A or earlier	Tuning-less type 1	–
000B or later	Tuning-less type 2	The level of noise produced is lower than that of Type 1.

* The software version number of your SERVOPACK can be checked with Fn012.

Parameter	Meaning	When Enabled	Classification
Pn14F	n.□□0□	After restart	Tuning
	n.□□1□ [Factory setting]		

6.2.3 Related Parameters

The following table lists parameters related to this function and their possibility of being changed while executing this function or of being changed automatically after executing this function.

- Parameters related to this function

These are parameters that are used or referenced when executing this function.

- Allowed changes during execution of this function

Yes : Parameters can be changed using SigmaWin+ while this function is being executed.

No : Parameters cannot be changed using SigmaWin+ while this function is being executed.

- Automatic changes after execution of this function

Yes : Parameter set values are automatically set or adjusted after execution of this function.

No : Parameter set values are not automatically set or adjusted after execution of this function.

Parameter	Name	Mid-execution changes	Automatic changes
Pn170	Tuning-less Function Related Switch	No	Yes
Pn401	Torque Reference Filter Time Constant	No	Yes
Pn40C	2nd Notch Filter Frequency	No	Yes
Pn40D	2nd Notch Filter Q Value	No	Yes

6.3 Advanced Autotuning (Fn201)

This section describes the adjustment using advanced autotuning.



IMPORTANT

- Advanced autotuning starts adjustments based on the set speed loop gain (Pn100). Therefore, precise adjustments cannot be made if there is vibration when starting adjustments. In this case, make adjustments after lowering the speed loop gain (Pn100) until vibration is eliminated.
- Before performing advanced autotuning with the tuning-less function enabled (Pn170.0 = 1: Factory setting), always set Jcalc to ON to calculate the load moment of inertia. The tuning-less function will automatically be disabled, and the gain will be set by advanced autotuning.
With Jcalc set to OFF so the load moment of inertia is not calculated, "Error" will be displayed on the panel operator, and advanced autotuning will not be performed.
- If the operating conditions, such as the machine-load or drive system, are changed after advanced autotuning, then change the following related parameters to disable any values that were adjusted before performing advanced autotuning once again with the setting to calculate the moment of inertia (Jcalc = ON). If advanced autotuning is performed without changing the parameters, machine vibration may occur, resulting in damage to the machine.
Pn00B.0=1 (Displays all parameters.)
Pn140.0=0 (Does not use model following control.)
Pn160.0=0 (Does not use anti-resonance control.)
Pn408=n.00□0 (Does not use friction compensation, 1st notch filter, or 2nd notch filter.)

6.3.1 Advanced Autotuning

Advanced autotuning automatically operates the servo system (in reciprocating movement in the forward and reverse directions) within set limits and adjust the SERVOPACK automatically according to the mechanical characteristics while the servo system is operating.

Advanced autotuning can be performed without connecting the host controller. The following automatic operation specifications apply.

- Maximum speed: Rated motor speed $\times 2/3$
- Acceleration torque: Approximately 100% of rated motor torque
The acceleration torque varies with the influence of the moment of inertia ratio (Pn103), machine friction, and external disturbance.
- Travel distance: The travel distance can be set freely. The distance is factory-set to a value equivalent to 3 motor rotations.
For an SGMCS direct drive servomotor, the distance is factory-set to a value equivalent to 0.3 motor rotations.

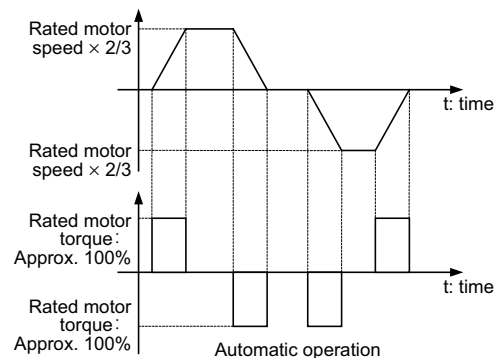
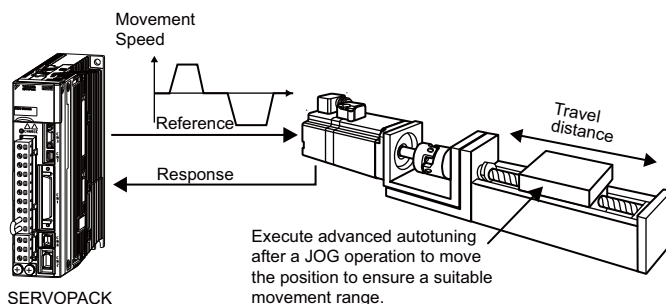

Advanced autotuning performs the following adjustments.

- Moment of inertia ratio
- Gains (e.g., position loop gain and speed loop gain)

- Filters (torque reference filter and notch filter)
- Friction compensation
- Anti-resonance control
- Vibration suppression (Mode = 2 or 3)

Refer to 6.3.3 *Related Parameters* for parameters used for adjustments.



CAUTION

- Because advanced autotuning adjusts the SERVOPACK during automatic operation, vibration or overshooting may occur. To ensure safety, perform advanced autotuning in a state where the SERVOPACK can come to an emergency stop at any time.

(1) Preparation

Check the following settings before performing advanced autotuning.

The message “NO-OP” indicating that the settings are not appropriate will be displayed, if all of the following conditions are not met.

- The main circuit power supply must be ON.
- There must be no overtravel.
- The servo ON signal (/S-ON) must be OFF.
- The control method must not be set to torque control.
- The gain selection switch must be in manual switching mode (Pn139.0 = 0).
- Gain setting 1 must be selected.
- The test without a motor function must be disabled (Pn00C.0 = 0).
- All alarms and warning must be cleared.
- The hardwire baseblock (HWBB) must be disabled.
- The write prohibited setting parameter (Fn010) must be set to Write permitted (P.0000).
- Jcalc must be set to ON to calculate the load moment of inertia when the tuning-less function is enabled (Pn170.0 = 1: factory setting) or the tuning-less function must be disabled (Pn170.0 = 0).

Notes:

- If advanced autotuning is started while the SERVOPACK is in speed control, the mode will change to position control automatically to perform advanced autotuning. The mode will return to speed control after completing the adjustment. To perform advanced autotuning in speed control, set the mode to 1 (Mode = 1).
- The reference pulse input multiplication switching function is disabled while performing advanced autotuning.

(2) When Advanced Autotuning Cannot Be Performed

Advanced autotuning cannot be performed normally under the following conditions. Refer to 6.4 *Advanced Autotuning by Reference (Fn202)* and 6.5 *One-parameter Tuning (Fn203)* for details.

- The machine system can work only in a single direction.
- The operating range is within 0.5 rotation. (Also for SGMCS direct drive motors, the operating range is within 0.05 rotation.)

(3) When Advanced Autotuning Cannot Be Performed Successfully

Advanced autotuning cannot be performed successfully under the following conditions. Refer to 6.4 *Advanced Autotuning by Reference (Fn202)* and 6.5 *One-parameter Tuning (Fn203)* for details.

- The operating range is not applicable.
- The moment of inertia changes within the set operating range.
- The machine has high friction.
- The rigidity of the machine is low and vibration occurs when positioning is performed.
- The position integration function is used.
- P control operation (proportional control) is used.

Note: If a setting is made for calculating the moment of inertia, an error will result when P control operation is selected using /P-CON signal while the moment of inertia is being calculated.

- The mode switch is used.

Note: If a setting is made for calculating the moment of inertia, the mode switch function will be disabled while the moment of inertia is being calculated. At that time, PI control will be used. The mode switch function will be enabled after calculating the moment of inertia.

- Speed feedforward or torque feedforward is input.
- The positioning completed width (Pn522) is too small.



IMPORTANT

- Advanced autotuning makes adjustments by referring to the positioning completed width (Pn522). If the SERVOPACK is operated in position control (Pn000.1=1), set the electronic gear ratio (Pn20E/Pn210) and positioning completed width (Pn522) to the actual value during operation. If the SERVOPACK is operated in speed control (Pn000.1=0), set Mode to 1 to perform advanced autotuning.
- Unless the positioning completed signal (/COIN) is turned ON within approximately 3 seconds after positioning has been completed, "WAITING" will flash. Furthermore, unless the positioning completed signal (/COIN) is turned ON within approximately 10 seconds, "Error" will flash for 2 seconds and tuning will be aborted.

Change only the overshoot detection level (Pn561) to finely adjust the amount of overshooting without changing the positioning completed width (Pn522). Because Pn561 is set by default to 100%, the allowable amount of overshooting is the same amount as that for the positioning completed width.

When Pn561 is set to 0%, the amount of overshooting can be adjusted to prevent overshooting the positioning completed width. If the setting of Pn561 is changed, however, the positioning time may be extended.

Pn561	Overshoot Detection Level				Classification	
			Speed	Position		Torque
	Setting Range	Setting Unit	Factory Setting	When Enabled		
	0 to 100	1%	100	Immediately	Setup	

(4) Restrictions When Using an Encoder

With this function, the following restrictions are applied in accordance with the version number of the SERVOPACK software and the encoder being used.

The applicable servomotor depends on the type of encoder used.

- 13-bit encoder: SGMJV-□□□A□□□
- 20-bit or 17-bit encoder: SGM□V-□□□D□□□, SGM□V-□□□3□□□
SGMPS-□□□C□□□, SGMPS-□□□2□□□

Software Version *1	13-bit Encoder		20-bit or 17-bit Encoder	
	Mode	Model Following Control Type	Mode	Model Following Control Type
Version 0007 or earlier	Only Mode 1 can be selected.*2	_*3	No restrictions	Type 1*4
Version 0008 or later	Only Mode 1 can be selected.			Type 1 or 2 [Factory setting]*5

- *1. The software version number of your SERVOPACK can be checked with Fn012.
- *2. If any mode other than Mode 1 is selected, tuning will fail and result in an error.
- *3. Model following control type is not used.
- *4. Position errors may result in overshooting when positioning. The positioning time may be extended if the positioning completed width (Pn522) is set to a small value.
- *5. Model following control type 2 can suppress overshooting resulting from position errors better than Type 1. If compatibility with SERVOPACK version 0007 or earlier is required, use model following control type 1 (Pn14F.0 = 0).

The control related switch (Pn14F) was added to SERVOPACK software version 0008 or later.

Parameter	Function	When Enabled	Classification
Pn14F	n.□□□0	After restart	Tuning
	n.□□□1 [Factory setting]		

6.3.2 Advanced Autotuning Procedure















The following procedure is used for advanced autotuning.

Advanced autotuning is performed from the digital operator (option) or SigmaWin+. The function cannot be performed from the panel operator.













The operating procedure from the digital operator is described here.

Refer to the *Σ-V Series User's Manual, Operation of Digital Operator* (No.: SIEP S800000 55) for basic key operations of the digital operator.







(1) Operating Procedure

Step	Display after Operation	Keys	Operation
1	<pre> BB — FUNCTION — Fn200: TuneLvl Set Fn201: AAT Fn202: Ref-AAT Fn203: OnePrmTun </pre>	  	<p>Press the  Key to view the main menu for the utility function.</p> <p>Use the  or  Key to move through the list, select Fn201.</p>
2	<pre> BB Advanced AT Jcalc=ON Mode=2 Type=2 Stroke=+00800000 (0003.0) rev </pre>		<p>Press the  Key to display the initial setting screen for advanced autotuning.</p>
3	<pre> BB Advanced AT Jcalc=ON Mode=2 Type=2 Stroke=+00800000 (0003.0) rev </pre>	  	<p>Press the , , or  Key and set the items in steps 3-1 to 3-4.</p>
3-1	<p>■Calculating Moment of Inertia</p> <p>Select the mode to be used.</p> <p>Usually, set Jcalc to ON.</p> <p>Jcalc = ON: Moment of inertia calculated [Factory setting]</p> <p>Jcalc = OFF: Moment of inertia not calculated</p> <p>Note:</p> <p>If the moment of inertia ratio is already known from the machine specifications, set the value in Pn103 and set Jcalc to OFF.</p>		
3-2	<p>■Mode Selection</p> <p>Select the mode.</p> <p>Mode = 1: Makes adjustments considering response characteristics and stability (Standard level).</p> <p>Mode = 2: Makes adjustments for positioning [Factory setting].</p> <p>Mode = 3: Makes adjustments for positioning, giving priority to overshooting suppression.</p>		
3-3	<p>■Type Selection</p> <p>Select the type according to the machine element to be driven. If there is noise or the gain does not increase, better results may be obtained by changing the rigidity type.</p> <p>Type = 1: For belt drive mechanisms</p> <p>Type = 2: For ball screw drive mechanisms [Factory setting]</p> <p>Type = 3: For rigid systems in which the servomotor is directly coupled to the machine (without gear or other transmissions)</p>		

(cont'd)

Step	Display after Operation	Keys	Operation
3-4	<p>■STROKE (Travel Distance) Setting</p> <p>Travel distance setting range: The travel distance setting range is from -99990000 to +99990000 [reference unit]. Specify the STROKE (travel distance) in increments of 1000 reference units. The negative (-) direction is for reverse rotation, and the positive (+) direction is for forward rotation.</p> <p>Initial value: About 3 rotations</p> <p>Notes:</p> <ul style="list-style-type: none"> Set the number of motor rotations to at least 0.5; otherwise, "Error" will be displayed and the travel distance cannot be set. To calculate the moment of inertia and ensure precise tuning, it is recommended to set the number of motor rotations to around 3. For an SGMCS direct drive servomotor, the factory setting for distance is set to a value that is equivalent to 0.3 motor rotations. 		
4	<pre>BB Advanced AT Pn103=00100 Pn100=0040.0 Pn101=0020.00 Pn102=0040.0</pre>		Press the  Key. The advanced autotuning execution screen will be displayed.
5	<pre>RUN Advanced AT Pn103=00100 Pn100=0040.0 Pn101=0020.00 Pn141=0050.0</pre>		Press the  Key. The servomotor power will be ON and the display will change from "BB" to "RUN." Note: If the mode is set to 1, Pn102 is displayed. If the mode is set to 2 or 3, the Pn102 display will change to the Pn141.
6	<pre>ADJ Advanced AT Pn103=00300 Pn100=0040.0 Pn101=0020.0 Pn141=0050.0</pre> <p>Display example: After the moment of inertia is calculated.</p>	 	Calculates the moment of inertia. Press the  Key if a positive (+) value is set in STROKE (travel distance), or press the  Key if a negative (-) value is set. Calculation of the moment of inertia will start. While the moment of inertia is being calculated, the set value for Pn103 will flash and "ADJ" will flash instead of "RUN." When calculating the moment of inertia is completed, the display will stop flashing and the moment of inertia is displayed. The servomotor will remain ON, but the auto run operation will be stopped temporarily. Notes: <ul style="list-style-type: none"> The wrong key for the set travel direction is pressed, the calculation will not start. If the moment of inertia is not calculated (Jcalc = OFF), the set value for Pn103 will be displayed. If "NO-OP" or "Error" is displayed during operation, press the  Key to cancel the function. Refer to (2) <i>Failure in Operation</i> and take a corrective action to enable operation.
7		 	After the servomotor is temporarily stopped, press the  Key to save the calculated moment of inertia ratio in the SERVOPACK. "DONE" will flash for one second, and "ADJ" will be displayed again. Notes: To end operation by calculating only the moment of inertia ratio and without adjusting the gain, press the  Key to end operation.

(cont'd)

Step	Display after Operation	Keys	Operation
8	<pre> ADJ Advanced AT Pn103=00300 Pn100=0100.0 Pn101=0006.36 Pn141=0150.0 </pre>	 	<p>■ Gain Adjustment</p> <p>When the  or  Key is pressed according to the sign (+ or -) of the value set for stroke (travel distance), the calculated value of the moment of inertia ratio will be saved in the SERVOPACK and the auto run operation will restart. While the servomotor is running, the filters, and gains will be automatically set. "ADJ" will flash during the auto setting operation.</p> <p>Note: Precise adjustments cannot be made and "Error" will be displayed as the status if there is machine resonance when starting adjustments. If that occurs, make adjustments using one-parameter tuning (Fn203).</p>
9	<pre> ADJ Advanced AT Pn103=00300 Pn100=0100.0 Pn101=0006.36 Pn141=0150.0 </pre>		<p>When the adjustment has been completed normally, the servomotor power will turn OFF, and "END" will flash for approximately two seconds and then "ADJ" will be displayed on the status display.</p>
10	<pre> A.941 Advanced AT Pn103=00300 Pn100=0100.0 Pn101=0006.36 Pn141=0150.0 </pre>		<p>Press the  Key. The adjusted values will be saved in the SERVOPACK.</p> <ul style="list-style-type: none"> • If Pn170.0 = 1 (factory setting), "DONE" will flash for approximately two seconds, and "A.941" will be displayed. • If Pn170.0 = 0, "DONE" will flash for approximately two seconds, and "BB" will be displayed. <p>Note: Press the  Key to not save the values. The display will return to that shown in step 1.</p>
11	Turn ON the SERVOPACK power supply again after executing advanced autotuning.		

(2) Failure in Operation

■ When "NO-OP" Flashes on the Display

Probable Cause	Corrective Actions
The main circuit power supply was OFF.	Turn ON the main circuit power supply.
An alarm or warning occurred.	Remove the cause of the alarm or the warning.
Overtraveling occurred.	Remove the cause of the overtravel.
Gain setting 2 was selected by gain switching.	Disable the automatic gain switching.
The HWBB function operated.	Disable the HWBB function.

■ When "Error" Flashes on the Display

Error	Probable Cause	Corrective Actions
The gain adjustment was not successfully completed.	Machine vibration is occurring or the positioning completed signal (/COIN) is turning ON and OFF when the servomotor is stopped.	<ul style="list-style-type: none"> • Increase the set value for Pn522. • Change the mode from 2 to 3. • If machine vibration occurs, suppress the vibration with the anti-resonance control adjustment function and the vibration suppression function.
An error occurred during the calculation of the moment of inertia.	Refer to the following table ■ <i>When an Error Occurs during Calculation of Moment of Inertia.</i>	
Travel distance setting error	The travel distance is set to approximately 0.5 rotation (0.05 rotation for SGMCS servomotor) or less, which is less than the minimum adjustable travel distance.	Increase the travel distance. It is recommended to set the number of motor rotations to around 3.
The positioning completed signal (/COIN) did not turn ON within approximately 10 seconds after positioning adjustment was completed.	The positioning completed width is too narrow or proportional control (P control) is being used.	<ul style="list-style-type: none"> • Increase the set value for Pn522. • If P control is used, turn OFF the /P-CON signal.
The moment of inertia cannot be calculated when the tuning-less function was activated.	When the tuning-less function was activated, Jcalc was set to OFF so the moment of inertia was not calculated.	<ul style="list-style-type: none"> • Turn OFF the tuning-less function. • Set Jcalc to ON, so the moment of inertia will be calculated.

■ When an Error Occurs during Calculation of Moment of Inertia

The following table shows the probable causes of errors that may occur during the calculation of the moment of inertia with the Jcalc set to ON, along with corrective actions for the errors.

Error Display	Probable Cause	Corrective Actions
Err1	The SERVOPACK started calculating the moment of inertia, but the calculation was not completed.	<ul style="list-style-type: none"> • Increase the speed loop gain (Pn100). • Increase the STROKE (travel distance).
Err2	The moment of inertia fluctuated greatly and did not converge within 10 tries.	Set the calculation value based on the machine specifications in Pn103 and execute the calculation with the Jcalc set to OFF.
Err3	Low-frequency vibration was detected.	Double the set value of the moment of inertia calculating start level (Pn324).
Err4	The torque limit was reached.	<ul style="list-style-type: none"> • When using the torque limit, increase the torque limit. • Double the set value of the moment of inertia calculating start level (Pn324).
Err5	While calculating the moment of inertia, the speed control was set to proportional control with the /P-CON input.	Operate the SERVOPACK with PI control while calculating the moment of inertia.

(3) Related Functions on Advanced Autotuning

This section describes functions related to advanced tuning.

■ Notch Filter

Usually, set this function to Auto Setting. (The notch filter is factory-set to Auto Setting.)

If this function is set to Auto Setting, vibration will be detected automatically during advanced autotuning and the notch filter will be set.

Set this function to Not Auto Setting only if you do not change the notch filter setting before executing advanced autotuning.

Parameter		Function	When Enabled	Classification
Pn460	n.□□□0	Does not set the 1st notch filter automatically with the utility function.	Immediately	Tuning
	n.□□□1 [Factory setting]	Sets the 1st notch filter automatically with the utility function.		
	n.□0□□	Does not set the 2nd notch filter automatically with the utility function.		
	n.□1□□ [Factory setting]	Sets the 2nd notch filter automatically with the utility function.		

■ Anti-Resonance Control Adjustment

This function reduces low vibration frequency, which the notch filter does not detect.

Usually, set this function to Auto Setting. (The anti-resonance control is factory-set to Auto Setting.)

When this function is set to Auto Setting, vibration will be automatically detected during advanced autotuning and anti-resonance control will be automatically adjusted and set.

Parameter		Function	When Enabled	Classification
Pn160	n.□□0□	Does not use the anti-resonance control automatically with the utility function.	Immediately	Tuning
	n.□□1□ [Factory setting]	Uses the anti-resonance control automatically with the utility function.		

■ Vibration Suppression

The vibration suppression function suppresses transitional vibration at frequency as low as 1 to 100 Hz that is generated mainly when positioning if the machine stand vibrates.

Usually, set this function to Auto Setting. (The vibration suppression function is factory-set to Auto Setting.)

When this function is set to Auto Setting, vibration will be automatically detected during advanced autotuning and vibration suppression will be automatically adjusted and set.

Set this function to Not Auto Setting only if you do not change the setting for vibration suppression before executing advanced autotuning.

Note: This function uses model following control. Therefore, the function can be executed only if the mode is set to 2 or 3.

• Related Parameter

Parameter		Function	When Enabled	Classification
Pn140	n.□0□□	Does not use the vibration suppression function automatically with the utility function.	Immediately	Tuning
	n.□1□□ [Factory setting]	Uses the vibration suppression function automatically with the utility function.		

■ Friction Compensation

This function compensates for changes in the following conditions.

- Changes in the viscous resistance of the lubricant, such as the grease, on the sliding parts of the machine
- Changes in the friction resistance resulting from variations in the machine assembly
- Changes in the friction resistance due to aging

The conditions for applying friction compensation depend on the mode. The friction compensation setting in Pn408.3 applies when the Mode is 1. The friction compensation function is always enabled regardless of the friction compensation setting in Pn408.3 when the Mode is 2 or 3.

Friction Compensation Selecting		Mode		
		Mode = 1	Mode = 2	Mode = 3
Pn408	n.0□□□ [Factory setting]	Adjusted without the friction compensation function	Adjusted with the friction compensation function	Adjusted with the friction compensation function
	n.1□□□	Adjusted with the friction compensation function		

■ Feedforward

If Pn140 is set to the factory setting and the mode setting is changed to 2 or 3, the feedforward gain (Pn109), speed feedforward (V-REF) input, and torque feedforward (T-REF) input will be disabled.

Set Pn140.3 to 1 if model following control is used together with the speed feedforward (V-REF) input and torque feedforward (T-REF) input from the host controller.

Parameter		Function	When Enabled	Classification
Pn140	n.0□□□ [Factory setting]	Model following control is not used together with the speed/torque feedforward input.	Immediately	Tuning
	n.1□□□	Model following control is used together with the speed/torque feedforward input.		

Refer to 6.9.2 *Torque Feedforward* and 6.9.3 *Speed Feedforward* for details.

 IMPORTANT	<ul style="list-style-type: none"> • Model following control is used to make optimum feedforward settings in the SERVO-PACK when model following control is used with the feedforward function. Therefore, model following control is not normally used together with either the speed feedforward (V-REF) input or torque feedforward (T-REF) input from the host controller. However, model following control can be used with the speed feedforward (V-REF) input or torque feedforward (T-REF) input if required. An improper feedforward input may result in overshooting.
---	--

6.3.3 Related Parameters

The following table lists parameters related to this function and their possibility of being changed while executing this function or of being changed automatically after executing this function.

- Parameters related to this function

These are parameters that are used or referenced when executing this function.

- Allowed changes during execution of this function

Yes : Parameters can be changed using SigmaWin+ while this function is being executed.

No : Parameters cannot be changed using SigmaWin+ while this function is being executed.

- Automatic changes after execution of this function

Yes : Parameter set values are automatically set or adjusted after execution of this function.

No : Parameter set values are not automatically set or adjusted after execution of this function.

Parameter	Name	Mid-execution changes	Automatic changes
Pn100	Speed Loop Gain	No	Yes
Pn101	Speed Loop Integral Time Constant	No	Yes
Pn102	Position Loop Gain	No	Yes
Pn103	Moment of Inertia Ratio	No	No
Pn121	Friction Compensation Gain	No	Yes
Pn123	Friction Compensation Coefficient	No	Yes
Pn124	Friction Compensation Frequency Correction	No	No
Pn125	Friction Compensation Gain Correction	No	Yes
Pn401	Torque Reference Filter Time Constant	No	Yes
Pn408	Torque Related Function Switch	Yes	Yes
Pn409	1st Notch Filter Frequency	No	Yes
Pn40A	1st Notch Filter Q Value	No	Yes
Pn40C	2nd Notch Filter Frequency	No	Yes
Pn40D	2nd Notch Filter Q Value	No	Yes
Pn140	Model Following Control Related Switch	Yes	Yes
Pn141	Model Following Control Gain	No	Yes
Pn142	Model Following Control Gain Compensation	No	Yes
Pn143	Model Following Control Bias (Forward Direction)	No	Yes
Pn144	Model Following Control Bias (Reverse Direction)	No	Yes
Pn145	Vibration Suppression 1 Frequency A	No	Yes
Pn146	Vibration Suppression 1 Frequency B	No	Yes
Pn147	Model Following Control Speed Feedforward Compensation	No	Yes
Pn160	Anti-Resonance Control Related Switch	Yes	Yes
Pn161	Anti-Resonance Frequency	No	Yes
Pn163	Anti-Resonance Damping Gain	No	Yes
Pn531	Program JOG Movement Distance	No	No
Pn533	Program JOG Movement Speed	No	No
Pn534	Program JOG Acceleration/Deceleration Time	No	No
Pn535	Program JOG Waiting Time	No	No
Pn536	Number of Times of Program JOG Movement	No	No

6.4 Advanced Autotuning by Reference (Fn202)

Adjustments with advanced autotuning by reference are described below.



IMPORTANT

- Advanced autotuning by reference starts adjustments based on the set speed loop gain (Pn100). Therefore, precise adjustments cannot be made if there is vibration when starting adjustments. In this case, make adjustments after lowering the speed loop gain (Pn100) until vibration is eliminated.

6.4.1 Advanced Autotuning by Reference

Advanced autotuning by reference is used to automatically achieve optimum tuning of the SERVOPACK in response to the user reference inputs (pulse train reference) from the host controller.

Advanced autotuning by reference is performed generally to fine-tune the SERVOPACK after advanced autotuning of the SERVOPACK has been performed.

If the moment of inertia ratio is correctly set to Pn103, advanced autotuning by reference can be performed without performing advanced autotuning.

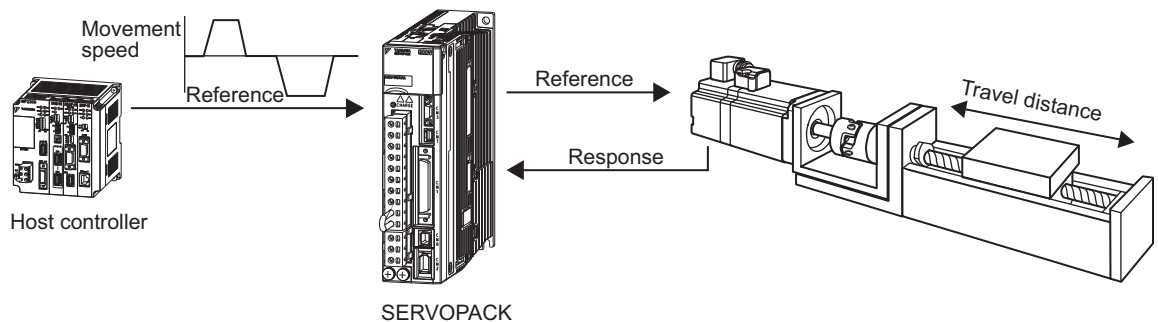

Advanced autotuning by reference performs the following adjustments.

- Gains (e.g., position loop gain and speed loop gain)
- Filters (torque reference filter and notch filter)
- Friction compensation
- Anti-resonance control
- Vibration suppression

Refer to 6.4.3 *Related Parameters* for parameters used for adjustments.



CAUTION

- Because advanced autotuning by reference adjusts the SERVOPACK during automatic operation, vibration or overshooting may occur. To ensure safety, perform advanced autotuning by reference in a state where the SERVOPACK can come to an emergency stop at any time.

(1) Preparation

Check the following settings before performing advanced autotuning by reference. The message “NO-OP” indicating that the settings are not appropriate will be displayed, if all of the following conditions are not met.

- The SERVOPACK must be in Servo Ready status (Refer to 5.10.4).
- There must be no overtravel.
- The servo ON signal (/S-ON) must be OFF.
- The position control must be selected when the servomotor power is ON.
- The gain selection switch must be in manual switching mode (Pn139.0 = 0).
- Gain setting 1 must be selected.
- The test without a motor function must be disabled. (Pn00C.0 = 0).
- All warnings must be cleared.
- The write prohibited setting parameter (Fn010) must be set to Write permitted (P.0000).
- The tuning-less function must be disabled (Pn170.0 = 0).

(2) When Advanced Autotuning by Reference Cannot Be Performed Successfully

Advanced autotuning by reference cannot be performed successfully under the following conditions. If the result of autotuning is not satisfactory, perform one-parameter tuning (Fn203). Refer to 6.5 *One-parameter Tuning (Fn203)* for details.

- The travel distance in response to references from the host controller is smaller than the set positioning completed width (Pn522).
- The motor speed in response to references from the host controller is smaller than the set rotation detection level (Pn502).
- The stopping time, i.e., the period while the positioning completed /COIN signal is OFF, is 10 ms or less.
- The rigidity of the machine is low and vibration occurs when positioning is performed.
- The position integration function is used.
- P control operation (proportional control) is performed.
- The mode switch is used.
- The positioning completed width (Pn522) is too small.

 IMPORTANT	<ul style="list-style-type: none"> • Advanced autotuning by reference starts adjustments based on the positioning completed width (Pn522). Set the electronic gear ratio (Pn20E/Pn210) and positioning completed width (Pn522) to the actual value during operation. • Unless the positioning completed signal (/COIN) is turned ON within approximately 3 seconds after positioning has been completed, "WAITING" will flash. Furthermore, unless the positioning completed signal (/COIN) is turned ON within approximately 10 seconds, "Error" will flash for 2 seconds and tuning will be aborted.
---	--

Change only the overshoot detection level (Pn561) to finely adjust the amount of overshooting without changing the positioning completed width (Pn522). Because Pn561 is set by default to 100%, the allowable amount of overshooting is the same amount as that for the positioning completed width.

When Pn561 is set to 0%, the amount of overshooting can be adjusted without any overshooting in the positioning completed width. If the setting of Pn561 is changed, however, the positioning time may be extended.

Pn561	Overshoot Detection Level				Classification
	Setting Range	Setting Unit	Speed	Position	
			Factory Setting	Torque	
	0 to 100	1%	100	Immediately	Setup

(3) Restrictions When Using an Encoder

With this function, the following restrictions are applied in accordance with the version number of the SERVOPACK software and the encoder being used.

The applicable servomotor depends on the type of encoder used.

- 13-bit encoder: SGMJV-□□□A□□□
- 20-bit or 17-bit encoder: SGM□V-□□□D□□□, SGM□V-□□□3□□□
SGMPS-□□□C□□□, SGMPS-□□□2□□□

Software Version*1	13-bit Encoder		20-bit or 17-bit Encoder	
	Mode	Model Following Control Type	Mode	Model Following Control Type
Version 0007 or earlier	Only Mode 1 can be selected.*2	_*3	No restrictions	Type 1*4
Version 0008 or later	Only Mode 1 can be selected.			Type 1 or 2 [Factory setting]*5

- *1. The software version number of your SERVOPACK can be checked with Fn012.
 *2. If any mode other than Mode 1 is selected, tuning will fail and result in an error.
 *3. Model following control type is not used.
 *4. Position errors may result in overshooting when positioning. The positioning time may be extended if the positioning completed width (Pn522) is set to a small value.
 *5. Model following control type 2 can suppress overshooting resulting from position errors better than Type 1. If compatibility with SERVOPACK version 0007 or earlier is required, use model following control type 1 (Pn14F.0 = 0).

The control related switch (Pn14F) was added to SERVOPACK software version 0008 or later.

Parameter		Function	When Enabled	Classification
Pn14F	n.□□□0	Model following control type 1	After restart	Tuning
	n.□□□1 [Factory setting]	Model following control type 2		

6.4.2 Advanced Autotuning by Reference Procedure

The following procedure is used for advanced autotuning by reference.





















Advanced autotuning by reference is performed from the digital operator (option) or SigmaWin+. The function cannot be performed from the panel operator.

Here, the operating procedure from the digital operator is described.



Refer to the *Σ-V Series User's Manual, Operation of Digital Operator* (No.: SIEP S800000 55) for basic key operations of the digital operator.

(1) Operating Procedure

Set the correct moment of inertia ratio in Pn103 by using the advanced autotuning before performing this procedure.

Step	Display after Operation	Keys	Operation
1	<pre> BB — FUNCTION — Fn201 : AAT Fn202 : Ref-AAT Fn203 : OnePrmTun Fn204 : A-Vib Sup </pre>	  	<p>Press the  Key to view the main menu for the utility function.</p> <p>Use the  or  Key to move through the list and select Fn202.</p>
2	<pre> Status Display BB Advanced AT Mode=3 Type=2 </pre>		<p>Press the  Key to display the initial setting screen for advanced autotuning by reference.</p>
3	<pre> BB Advanced AT Mode=3 Type=2 </pre>	  	<p>Press the , , or  Key and set the items in steps 3-1 and 3-2.</p>
3-1	<p>■Mode Selection Select the mode. Mode = 1: Makes adjustments considering response characteristics and stability (Standard level). Mode = 2: Makes adjustments for positioning [Factory setting]. Mode = 3: Makes adjustments for positioning, giving priority to overshooting suppression.</p>		
3-2	<p>■Type Selection Select the type according to the machine element to be driven. If there is noise or the gain does not increase, better results may be obtained by changing the rigidity type. Type = 1: For belt drive mechanisms Type = 2: For ball screw drive mechanisms [Factory setting] Type = 3: For rigid systems in which the servomotor is directly coupled to the machine (without gear or other transmissions)</p>		
4	<pre> BB Advanced AT Pn103=00300 Pn100=0040.0 Pn101=0020.00 Pn141=0050.0 </pre>		<p>Press the  Key. The advanced autotuning by reference execution screen will be displayed.</p> <p>Note: If the mode is set to 1, Pn102 is displayed. If the mode is set to 2 or 3, the Pn102 display will change to the Pn141.</p>
5	<pre> RUN Advanced AT Pn103=00300 Pn100=0040.0 Pn101=0020.00 Pn141=0050.0 </pre>		<p>Input servo ON signal (/S-ON) from an external device.</p>
6	<pre> ADJ Advanced AT Pn103=00300 Pn100=0100.0 Pn101=0006.36 Pn141=0150.0 </pre>	 	<p>Input a reference from the host controller and then press the  or  Key to start the adjustment. "ADJ" will flash during adjustment on the status display.</p> <p>Note: Adjustment cannot be performed during "BB" is shown on the status display.</p>

(cont'd)

Step	Display after Operation	Keys	Operation
7	<pre> ADJ A d v a n c e d A T P n 1 0 3 = 0 0 3 0 0 P n 1 0 0 = 0 1 0 0 . 0 P n 1 0 1 = 0 0 0 6 . 3 6 P n 1 4 1 = 0 1 5 0 . 0 </pre>		When the adjustment has been completed normally, "END" will flash for approximately two seconds and "ADJ" will be displayed.
8	<pre> RUN A d v a n c e d A T P n 1 0 3 = 0 0 3 0 0 P n 1 0 0 = 0 1 0 0 . 0 P n 1 0 1 = 0 0 0 6 . 3 6 P n 1 4 1 = 0 1 5 0 . 0 </pre>	<div style="border: 1px solid black; padding: 2px; display: inline-block;">DATA</div>	Press the  Key to save the settings. "DONE" will flash for approximately two seconds and "RUN" will be displayed. Note: Not to save the values set in step 6, press the  Key. The display will return to that shown in step 1.
9	Turn ON the SERVOPACK power supply again after executing advanced autotuning by reference.		

(2) Failure in Operation

■ When "NO-OP" Flashes on the Display

Probable Cause	Corrective Actions
The main circuit power supply was OFF.	Turn ON the main circuit power supply.
An alarm or warning occurred.	Remove the cause of the alarm or the warning.
Overtraveling occurred.	Remove the cause of the overtravel.
Gain setting 2 was selected by gain switching.	Disable the automatic gain switching.
HWBB operated.	Disable the HWBB function.

■ When "Error" Flashes on the Display

Error	Probable Cause	Corrective Actions
The gain adjustment was not successfully completed.	Machine vibration is occurring or the positioning completed signal (/COIN) is turning ON and OFF when the servomotor is stopped.	<ul style="list-style-type: none"> • Increase the set value for Pn522. • Change the mode from 2 to 3. • If machine vibration occurs, suppress the vibration with the anti-resonance control adjustment function and the vibration suppression function.
The positioning completed signal (/COIN) did not turn ON within approximately 10 seconds after positioning adjustment was completed.	The positioning completed width is too narrow or proportional control (P control) is being used.	<ul style="list-style-type: none"> • Increase the set value for Pn522. • If P control is used, turn OFF the /P-CON signal.

(3) Related Functions on Advanced Autotuning by Reference

This section describes functions related to advanced autotuning by reference.

■ Notch Filter

Usually, set this function to Auto Setting. (The notch filter is factory-set to Auto Setting.)

If this function is set to Auto Setting, vibration will be detected automatically during advanced autotuning by reference, and the notch filter will be set.

Set this function to Not Auto Setting only if you do not change the notch filter setting before executing advanced autotuning by reference.

Parameter		Function	When Enabled	Classification
Pn460	n.□□□0	Does not set the 1st notch filter automatically with the utility function.	Immediately	Tuning
	n.□□□1 [Factory setting]	Sets the 1st notch filter automatically with the utility function.		
	n.□0□□	Does not set the 2nd notch filter automatically with the utility function.		
	n.□1□□ [Factory setting]	Sets the 2nd notch filter automatically with the utility function.		

■ Anti-Resonance Control Adjustment

This function reduces low vibration frequency, which the notch filter does not detect.

Usually, set this function to Auto Setting. (The anti-resonance control is factory-set to Auto Setting.)

When this function is set to Auto Setting, vibration will be automatically detected during advanced autotuning by reference and anti-resonance control will be automatically adjusted and set.

Parameter		Function	When Enabled	Classification
Pn160	n.□□0□	Does not use the anti-resonance control automatically with the utility function.	Immediately	Tuning
	n.□□1□ [Factory setting]	Uses the anti-resonance control automatically with the utility function.		

■ Vibration Suppression

The vibration suppression function suppresses transitional vibration at frequency as low as 1 to 100 Hz that is generated mainly when positioning if the machine stand vibrates.

Usually, set this function to Auto Setting. (The vibration suppression function is factory-set to Auto Setting.)

When this function is set to Auto Setting, vibration will be automatically detected during advanced autotuning by reference and vibration suppression will be automatically adjusted and set.

Set this function to Not Auto Setting only if you do not change the setting for vibration suppression before executing advanced autotuning by reference.

Note: This function uses model following control. Therefore, the function can be executed only if the mode is set to 2 or 3.

• Related Parameters

Parameter		Function	When Enabled	Classification
Pn140	n.□0□□	Does not use the vibration suppression function automatically.	Immediately	Tuning
	n.□1□□ [Factory setting]	Uses the vibration suppression function automatically.		

■ Friction Compensation

This function compensates for changes in the following conditions.

- Changes in the viscous resistance of the lubricant, such as the grease, on the sliding parts of the machine
- Changes in the friction resistance resulting from variations in the machine assembly
- Changes in the friction resistance due to aging

Conditions to which friction compensation is applicable depend on the mode. The friction compensation setting in Pn408.3 applies when the mode is 1. Mode = 2 and Mode = 3 are adjusted with the friction compensation function regardless of the friction compensation setting in P408.3.

Friction Compensation Selecting		Mode = 1	Mode = 2	Mode = 3
Pn408	n.0□□□ [Factory setting]	Adjusted without the friction compensation function	Adjusted with the friction compensation function	Adjusted with the friction compensation function
	n.1□□□	Adjusted with the friction compensation function		

■ Feedforward

If Pn140 is set to the factory setting and the mode setting is changed to 2 or 3, the feedforward gain (Pn109), speed feedforward (V-REF) input, and torque feedforward (T-REF) input will be disabled.

Set Pn140.3 to 1 if model following control is used together with the speed feedforward (V-REF) input and torque feedforward (T-REF) input from the host controller.

Parameter	Function	When Enabled	Classification
Pn140	n.0□□□ [Factory setting]	Immediately	Tuning
	n.1□□□		

Refer to 6.9.2 *Torque Feedforward* and 6.9.3 *Speed Feedforward* for details.



IMPORTANT

- Model following control is used to make optimum feedforward settings in the SERVO-PACK when model following control is used with the feedforward function. Therefore, model following control is not normally used together with either the speed feedforward (V-REF) input or torque feedforward (T-REF) input from the host controller. However, model following control can be used with the speed feedforward (V-REF) input or torque feedforward (T-REF) input if required. An improper feedforward input may result in overshooting.

6.4.3 Related Parameters

The following table lists parameters related to this function and their possibility of being changed while executing this function or of being changed automatically after executing this function.

- Parameters related to this function

These are parameters that are used or referenced when executing this function.

- Allowed changes during execution of this function

Yes : Parameters can be changed using SigmaWin+ while this function is being executed.

No : Parameters cannot be changed using SigmaWin+ while this function is being executed.

- Automatic changes after execution of this function

Yes : Parameter set values are automatically set or adjusted after execution of this function.

No : Parameter set values are not automatically set or adjusted after execution of this function.

Parameter	Name	Mid-execution changes	Automatic changes
Pn100	Speed Loop Gain	No	Yes
Pn101	Speed Loop Integral Time Constant	No	Yes
Pn102	Position Loop Gain	No	Yes
Pn103	Moment of Inertia Ratio	No	No
Pn121	Friction Compensation Gain	No	Yes
Pn123	Friction Compensation Coefficient	No	Yes
Pn124	Friction Compensation Frequency Correction	No	No
Pn125	Friction Compensation Gain Correction	No	Yes
Pn401	Torque Reference Filter Time Constant	No	Yes
Pn408	Torque Related Function Switch	Yes	Yes
Pn409	1st Notch Filter Frequency	No	Yes
Pn40A	1st Notch Filter Q Value	No	Yes
Pn40C	2nd Notch Filter Frequency	No	Yes
Pn40D	2nd Notch Filter Q Value	No	Yes
Pn140	Model Following Control Related Switch	Yes	Yes
Pn141	Model Following Control Gain	No	Yes
Pn142	Model Following Control Gain Compensation	No	Yes
Pn143	Model Following Control Bias (Forward Direction)	No	Yes
Pn144	Model Following Control Bias (Reverse Direction)	No	Yes
Pn145	Vibration Suppression 1 Frequency A	No	Yes
Pn146	Vibration Suppression 1 Frequency B	No	Yes
Pn147	Model Following Control Speed Feedforward Compensation	No	Yes
Pn160	Anti-Resonance Control Related Switch	Yes	Yes
Pn161	Anti-Resonance Frequency	No	Yes
Pn163	Anti-Resonance Damping Gain	No	Yes

6.5 One-parameter Tuning (Fn203)

Adjustments with one-parameter tuning are described below.

6.5.1 One-parameter Tuning

One-parameter tuning is used to manually make tuning level adjustments during operation with a position reference or speed reference input from the host controller.

One-parameter tuning enables automatically setting related servo gain settings to balanced conditions by adjusting one or two tuning levels.

One-parameter tuning performs the following adjustments.

- Gains (e.g., position loop gain and speed loop gain)
- Filters (torque reference filter and notch filter)
- Friction compensation
- Anti-resonance control

Refer to 6.5.4 *Related Parameters* for parameters used for adjustments.

Perform one-parameter tuning if satisfactory response characteristics is not obtained with advanced autotuning or advanced autotuning by reference.

To fine-tune each servo gain after one-parameter tuning, refer to 6.8 *Additional Adjustment Function*.



CAUTION

- Vibration or overshooting may occur during adjustment. To ensure safety, perform one-parameter tuning in a state where the SERVOPACK can come to an emergency stop at any time.

(1) Preparation

Check the following settings before performing one-parameter tuning.

The message “NO-OP” indicating that the settings are not appropriate will be displayed, if all of the following conditions are not met.

- The test without a motor function must be disabled (Pn00C.0 = 0).
- The write prohibited setting parameter (Fn010) must be set to Write permitted (P.0000).
- The tuning-less function must be disabled (Pn170.0 = 0).
- The tuning mode must be set to 0 or 1 when performing speed control.

(2) Restrictions When Using an Encoder

With this function, the following restrictions are applied in accordance with the version number of the SERVOPACK software and the encoder being used.

The applicable servomotor depends on the type of encoder used.

- 13-bit encoder: SGMJV-□□□A□□□□
- 20-bit or 17-bit encoder: SGM□V-□□□D□□□□, SGM□V-□□□3□□□□
SGMPS-□□□C□□□□, SGMPS-□□□2□□□□

Software Version *1	13-bit Encoder		20-bit or 17-bit Encoder	
	Mode	Model Following Control Type	Mode	Model Following Control Type
Version 0007 or earlier	Tuning mode can be set to only 0 or 1. *2	_*3	No restrictions	Type 1 *4
Version 0008 or later	No restrictions			Type 1 or 2 [Factory setting] *5

*1. The software version number of your SERVOPACK can be checked with Fn012.

*2. If any mode other than Tuning Mode 1 is selected, tuning will fail and result in an error.

*3. Model following control type is not used.

*4. Position errors may result in overshooting when positioning. The positioning time may be extended if the positioning completed width (Pn522) is set to a small value.

*5. Model following control type 2 can suppress overshooting resulting from position errors better than Type 1. If compatibility with SERVOPACK version 0007 or earlier is required, use model following control type 1 (Pn14F.0 = 0).

The control related switch (Pn14F) was added to SERVOPACK software version 0008 or later.

Parameter		Function	When Enabled	Classification
Pn14F	n.□□□0	Model following control type 1	After restart	Tuning
	n.□□□1 [Factory setting]	Model following control type 2		

6.5.2 One-parameter Tuning Procedure

The following procedure is used for one-parameter tuning.

There are the following two operation procedures depending on the tuning mode being used.

- When the tuning mode is set to 0 or 1, the model following control will be disabled and one-parameter tuning will be used as the tuning method for applications other than positioning.
- When the tuning mode is set to 2 or 3, the model following control will be enabled and it can be used for tuning for positioning.

One-parameter tuning is performed from the panel operator, digital operator (option), or SigmaWin+.

Only tuning modes 0 and 1 can be selected from the panel operator. Make sure that the moment of inertia ratio (Pn103) is set correctly using advance autotuning before beginning operation.

The following section provides the operating procedure from the panel operator and digital operator.

























Refer to the *Σ-V Series User's Manual, Operation of Digital Operator* (No.: SIEP S800000 55) for basic key operations of the digital operator.

(1) Panel Operator Operating Procedure

Step	Display after Operation	Keys	Operation
1			Press the MODE/SET Key to select the utility function mode.
2			Press the UP or DOWN Key to move through the list and select Fn203.
3			Press the DATA/SHIFT Key for approximately one second. The screen shown on the left will be displayed.
4			Press the UP or DOWN Key to move through the list and select Tuning Mode. TUNING MODE 0: Makes adjustments giving priority to stability. 1: Makes adjustments giving priority to responsiveness. Note: TYPE (rigidity type) is fixed to 2.
5			If the servomotor power is OFF, input a servo ON signal (/S-ON) from the host controller. If the servomotor power is ON, go to step 6.
6			Press the DATA/SHIFT Key for less than one second. The one parameter gain data shown on the left will be displayed.
7			Press the UP or DOWN Key to change the one parameter gain value and change the actual servo gain (Pn100, Pn101, Pn102, and Pn401) at the same time. This tuning function terminates when you decide that the response output is satisfactory.
8			Press the MODE/SET Key to save the calculated four gains to the parameter. When tuning is finished, "done" will flash before returning to the screen shown on the left. Note: To end operation without saving the calculated gain, go to step 9.
9			Press the DATA/SHIFT Key for approximately one second. The display will return to Fn203.











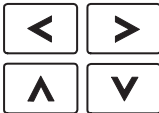



(2) Digital Operator Operating Procedure

■ Setting the Tuning Mode 0 or 1

























Step	Display after Operation	Keys	Operation
1	<pre> BB -FUNCTION- Fn202:Ref-AAT Fn203:OnePrmTun Fn204:A-Vib Sup Fn205:Vib Sup </pre>	  	<p>Press the  Key to view the main menu for the utility function.</p> <p>Press the  or  Key to move through the list and select Fn203.</p>
2	<pre> Status Display BB -OnePrmTun- Pn103=00300 </pre>		<p>Press the  Key to display the moment of inertia ratio set in Pn103 at present. Move the digit with the  or  Key and change the value with the  or  Key.</p>
3	<pre> BB -OnePrmTun- Setting Tuning Mode = 0 Type = 2 </pre>		<p>Press the  Key to display the initial setting screen for one-parameter tuning.</p>
4	<pre> BB -OnePrmTun- Setting Tuning Mode = 0 Type = 2 </pre>	  	<p>Press the , , or  Key and set the items in steps 4-1 and 4-2.</p>
4-1	<p>■ Tuning Mode</p> <p>Select the tuning mode. Select the tuning mode 0 or 1.</p> <p>Tuning Mode = 0: Makes adjustments giving priority to stability.</p> <p>Tuning Mode = 1: Makes adjustments giving priority to responsiveness.</p>		
4-2	<p>■ Type Selection</p> <p>Select the type according to the machine element to be driven.</p> <p>If there is noise or the gain does not increase, better results may be obtained by changing the rigidity type.</p> <p>Type = 1: For belt drive mechanisms</p> <p>Type = 2: For ball screw drive mechanisms [Factory setting]</p> <p>Type = 3: For rigid systems in which the servomotor is directly coupled to the machine (without gear or other transmissions).</p>		
5	<pre> RUN -OnePrmTun- Setting Tuning Mode = 0 Type = 2 </pre>		<p>If the servomotor power is OFF, input a servo ON signal (/S-ON) from the host controller. The display will change from "BB" to "RUN."</p> <p>If the servomotor power is ON, go to step 6.</p>
6	<pre> RUN -OnePrmTun- Pn100=0040.0 Pn101=0020.00 Pn102=0040.0 </pre>		<p>Press the  Key to display the set value.</p>
7	<pre> RUN -OnePrmTun- LEVEL = 0050 NF1 NF2 ARES </pre>		<p>Press the  Key again to display the LEVEL setting screen.</p>

Note: The status display will always be RUN when the servomotor power is ON.



















(cont'd)

Step	Display after Operation	Keys	Operation
8	<pre> RUN —OnePrmTun— LEVEL = 0050 NF1 NF2 ARES </pre>		<p>If readjustment is required, select the digit with the  or  Key or change the LEVEL with the  or  Key. Check the response.</p> <p>If readjustment is not required, go to step 9.</p> <p>Note: The higher the level, the greater the responsiveness will be. If the value is too large, however, vibration will occur.</p> <ul style="list-style-type: none"> If vibration occurs, press the  Key. The SERVOPACK will automatically detect the vibration frequencies and make notch filter or an anti-resonance control settings. When the notch filter is set, "NF1" or "NF2" will be displayed on the bottom row. When the anti-resonance control is set, "ARES" will be displayed in the lower right corner. <pre> RUN —OnePrmTun— LEVEL=0070 NF1 NF2 ARES </pre> <ul style="list-style-type: none"> If the vibration is great, the vibration frequency will be detected automatically even if the  Key is not pressed and a notch filter or an anti-resonance control will be set.
9	<pre> RUN —OnePrmTun— Pn100=0050.0 Pn101=0016.0 Pn102=0050.0 </pre>		<p>Press the  Key. A confirmation screen will be displayed after LEVEL adjustment.</p>
10	<pre> RUN —OnePrmTun— Pn100=0050.0 Pn101=0016.0 Pn102=0050.0 </pre>		<ul style="list-style-type: none"> Press the  Key to save the adjusted values. After the data is saved, "DONE" will flash for approximately two seconds and then "RUN" will be displayed. To return to the previous value, press the  Key. Press the  Key to readjust the level without saving the values.
11	<pre> RUN —FUNCTION— Fn202: Ref-AAT Fn203: OnePrmTun Fn204: A-Vib Sup Fn205: Vib Sup </pre>		<p>Press the  Key to complete the one-parameter tuning operation. The screen in step 1 will appear again.</p>

■ Setting the Tuning Mode 2 or 3

Step	Display after Operation	Keys	Operation
1	<pre>BB —FUNCTION— Fn202:Ref-AAT Fn203:OnePrmTun Fn204:A-Vib Sup Fn205:Vib Sup</pre>	  	<p>Press the  Key to view the main menu for the utility function.</p> <p>Press the  or  Key to move through the list and select Fn203.</p>
2	<p>Status Display</p> <pre>—OnePrmTun— Pn103=00300</pre>		<p>Press the  Key to display the moment of inertia ratio set in Pn103 at present. Move the digit with the  or  Key and change the value with the  or  Key.</p>
3	<pre>BB —OnePrmTun— Setting Tuning Mode = 2 Type = 2</pre>		<p>Press the  Key to display the initial setting screen for one-parameter tuning.</p>
4	<pre>BB —OnePrmTun— Setting Tuning Mode = 2 Type = 2</pre>	  	<p>Press the , , or  Key and set the items in steps 4-1 and 4-2.</p>
4-1	<p>■ Tuning Mode</p> <p>Select the tuning mode. Select the tuning mode 2 or 3.</p> <p>Tuning Mode = 2: Enables model following control and makes adjustments for positioning.</p> <p>Tuning Mode = 3: Enables model following control, makes adjustments for positioning, and suppresses overshooting.</p>		
4-2	<p>■ Type Selection</p> <p>Select the type according to the machine element to be driven.</p> <p>If there is noise or the gain does not increase, better results may be obtained by changing the rigidity type.</p> <p>Type = 1: For belt drive mechanisms</p> <p>Type = 2: For ball screw drive mechanisms [Factory setting]</p> <p>Type = 3: For rigid systems in which the servomotor is directly coupled to the machine (without gear or other transmissions).</p>		
5	<pre>RUN —OnePrmTun— Setting Tuning Mode=2 Type=2</pre>		<p>If the servomotor power is OFF, input a servo ON signal (/S-ON) from the host controller. The display will change from "BB" to "RUN."</p> <p>If the servomotor power is ON, go to step 6.</p>
6	<pre>RUN —OnePrmTun— Pn100=0040.0 Pn101=0020.00 Pn141=0050.0</pre>		<p>Press the  Key to display the set value.</p>
7	<pre>RUN —OnePrmTun— FF LEVEL=0050.0 FB LEVEL=0040.0</pre>		<p>Press the  Key again to display FF LEVEL and FB LEVEL setting screens.</p>

(cont'd)

Step	Display after Operation	Keys	Operation
8	<pre>RUN —OnePrmTun— FF LEVEL=0050.0 FB LEVEL=0040.0</pre>	   	<p>If readjustment is required, select the digit with the  or  Key or change the FF LEVEL and FB LEVEL with the  or  Key. Check the response.</p> <p>If readjustment is not required, go to step 9.</p> <p>Note: The higher the FF LEVEL, the positioning time will be shorter and the response will be better. If the level is too high, however, overshooting or vibration may occur. Overshooting will be reduced if the FB LEVEL is increased.</p> <p>■ If Vibration Occurs</p> <ul style="list-style-type: none"> If vibration occurs, press the  Key. The SERVOPACK will automatically detect the vibration frequencies and make notch filter or an anti-resonance control settings. When the notch filter is set, “NF1” and “NF2” are displayed on the bottom row. When the anti-resonance control is set, “ARES” will be displayed on the bottom low. <pre>RUN —OnePrmTun— FF LEVEL=0050.0 FB LEVEL=0040.0 NF1 NF2 ARES</pre> <p>■ If Vibration Is Large</p> <ul style="list-style-type: none"> Even if the  Key is not pressed, the SERVOPACK will automatically detect the vibration frequencies and make notch filter or anti-resonance control settings. <p>Notes:</p> <ul style="list-style-type: none"> If the FF LEVEL is changed when the servomotor is in operation, it will not be reflected immediately. The changes will be effective after the servomotor comes to a stop with no reference input and then the servomotor starts operation. If the FF LEVEL is changed too much during operation, vibration may occur because the responsiveness is changed rapidly when the settings become effective. The message “FF LEVEL” flashes until the machine reaches the effective FF LEVEL. If the servomotor does not stop within approximately 10 seconds after changing the setting, a timeout will occur. The setting will be returned to the previous value.
9	<pre>RUN —OnePrmTun— Pn100=0040.0 Pn101=0020.00 Pn141=0050.0 NF1</pre>		<p>Press the  Key to display the confirmation screen after level adjustment.</p>
10	<pre>RUN —OnePrmTun— Pn100=0040.0 Pn101=0020.00 Pn141=0050.0 NF1</pre>		<ul style="list-style-type: none"> Press the  Key to save the adjusted values. After the data is saved, “DONE” will flash for approximately two seconds and then “RUN” will be displayed. To return to the previous value, press the  Key. Press the  Key to readjust the level without saving the values.
11	<pre>RUN —FUNCTION— Fn202: Ref-AAT Fn203: OnePrmTun Fn204: A-Vib Sup Fn205: Vib Sup</pre>		<p>Press the  Key to complete the one-parameter tuning operation. The screen in step 1 will appear again.</p>

Note: The status display will always be RUN when the servomotor power is ON.

(3) Related Functions on One-parameter Tuning

This section describes functions related to one-parameter tuning.

■ Notch Filter

Usually, set this function to Auto Setting. (The notch filter is factory-set to Auto Setting.)

If this function is set to Auto Setting, vibration will be detected automatically during one-parameter tuning and the notch filter will be set.

Set this function to Not Auto Setting only if you do not change the notch filter setting before executing one-parameter tuning.

Parameter		Function	When Enabled	Classification
Pn460	n.□□□0	Does not set the 1st notch filter automatically with the utility function.	Immediately	Tuning
	n.□□□1 [Factory setting]	Sets the 1st notch filter automatically with the utility function.		
	n.□0□□	Does not set the 2nd notch filter automatically with the utility function.		
	n.□1□□ [Factory setting]	Sets the 2nd notch filter automatically with the utility function.		

■ Anti-Resonance Control Adjustment

This function reduces low vibration frequency, which the notch filter does not detect.

Usually, set this function to Auto Setting. (The anti-resonance control is factory-set to Auto Setting.)

When this function is set to Auto Setting, vibration will be automatically detected during one-parameter tuning and anti-resonance control will be automatically adjusted and set.

Parameter		Function	When Enabled	Classification
Pn160	n.□□0□	Does not use the anti-resonance control automatically with the utility function.	Immediately	Tuning
	n.□□1□ [Factory setting]	Uses the anti-resonance control automatically with the utility function.		

"ARES" will flash on the digital operator when anti-resonance control adjustment function is set.

```

RUN      —OnePrmTun—
FF LEVEL = 0050
FB LEVEL = 0040

NF1 NF2  ARES

```

■ Friction Compensation

This function compensates for changes in the following conditions.

- Changes in the viscous resistance of the lubricant, such as the grease, on the sliding parts of the machine
- Changes in the friction resistance resulting from variations in the machine assembly
- Changes in the friction resistance due to aging

Conditions to which friction compensation is applicable depend on the tuning mode. The friction compensation setting in F408.3 applies when the mode is 0 or 1. Tuning Mode = 2 and Tuning Mode = 3 are adjusted with the friction compensation function regardless of the friction compensation setting in P408.3.

Friction Compensation Selecting		Mode			
		Tuning Mode = 0	Tuning Mode = 1	Tuning Mode = 2	Tuning Mode = 3
Pn408	n.0□□□ [Factory setting]	Adjusted without the friction compensation function	Adjusted without the friction compensation function	Adjusted with the friction compensation function	Adjusted with the friction compensation function
	n.1□□□	Adjusted with the friction compensation function	Adjusted with the friction compensation function		

■ Feedforward

If Pn140 is set to the factory setting and the tuning mode setting is changed to 2 or 3, the feedforward gain (Pn109), speed feedforward (V-REF) input, and torque feedforward (T-REF) input will be disabled.

Set Pn140.3 to 1 if model following control is used together with the speed feedforward (V-REF) input and torque feedforward (T-REF) input from the host controller.



Parameter		Function	When Enabled	Classification
Pn140	n.0□□□ [Factory setting]	Model following control is not used together with the speed/torque feedforward input.	Immediately	Tuning
	n.1□□□	Model following control is used together with the speed/torque feedforward input.		

Refer to 6.9.2 *Torque Feedforward* and 6.9.3 *Speed Feedforward* for details.

 IMPORTANT	<ul style="list-style-type: none"> • Model following control is used to make optimum feedforward settings in the SERVO-PACK when model following control is used with the feedforward function. Therefore, model following control is not normally used together with either the speed feedforward (V-REF) input or torque feedforward (T-REF) input from the host controller. However, model following control can be used with the speed feedforward (V-REF) input or torque feedforward (T-REF) input if required. An improper feedforward input may result in overshooting.
---	--

6.5.3 One-parameter Tuning Example

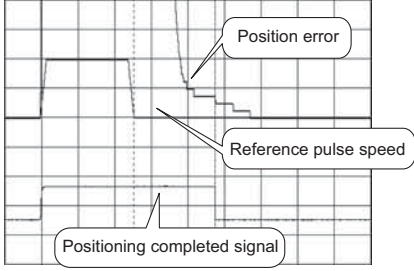
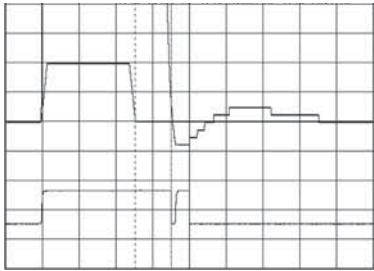
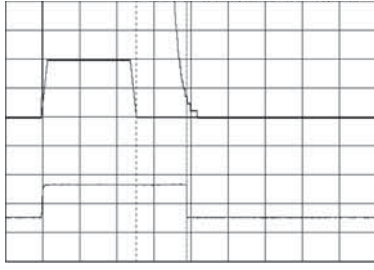
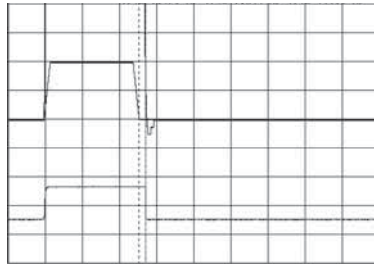
The following procedure is used for one-parameter tuning on the condition that the tuning mode is set to 2 or 3. This mode is used to reduce positioning time.

Step	Measuring Instrument Display Example	Operation
1		<p>Measure the positioning time after setting the moment of inertia ratio (Pn103) correctly. Tuning will be completed if the specifications are met here. The tuning results will be saved in the SERVOPACK.</p>
2		<p>The positioning time will become shorter if the FF level is increased. The tuning will be completed if the specifications are met. The tuning results will be saved in the SERVOPACK. If overshooting occurs before the specifications are met, go to step 3.</p>
3		<p>Overshooting will be reduced if the FB level is increased. If the overshooting is eliminated, go to step 4.</p>
4		<p>The graph shows overshooting generated with the FF level increased after step 3. In this state, the overshooting occurs, but the positioning settling time is shorter. The tuning will be completed if the specifications are met. The adjustment results are saved in the SERVOPACK. If overshooting occurs before the specifications are met, repeat steps 3 and 4. If vibration occurs before the overshooting is eliminated, the vibration will be suppressed by the automatic notch filter and anti-resonance control. Note: The vibration frequencies may not be detected if the vibration is too small. If that occurs, press the  Key to forcibly detect the vibration frequencies.</p>
5		<p>The adjustment results are saved in the SERVOPACK.</p>

6.5.4 Related Parameters

The following table lists parameters related to this function and their possibility of being changed while executing this function or of being changed automatically after executing this function.

- Parameters related to this function

These are parameters that are used or referenced when executing this function.

- Allowed changes during execution of this function

Yes : Parameters can be changed using SigmaWin+ while this function is being executed.

No : Parameters cannot be changed using SigmaWin+ while this function is being executed.

- Automatic changes after execution of this function

Yes : Parameter set values are automatically set or adjusted after execution of this function.

No : Parameter set values are not automatically set or adjusted after execution of this function.

Parameter	Name	Mid-execution changes	Automatic changes
Pn100	Speed Loop Gain	No	Yes
Pn101	Speed Loop Integral Time Constant	No	Yes
Pn102	Position Loop Gain	No	Yes
Pn103	Moment of Inertia Ratio	No	No
Pn121	Friction Compensation Gain	No	Yes
Pn123	Friction Compensation Coefficient	No	Yes
Pn124	Friction Compensation Frequency Correction	No	No
Pn125	Friction Compensation Gain Correction	No	Yes
Pn401	Torque Reference Filter Time Constant	No	Yes
Pn408	Torque Related Function Switch	Yes	Yes
Pn409	1st Notch Filter Frequency	No	Yes
Pn40A	1st Notch Filter Q Value	No	Yes
Pn40C	2nd Notch Filter Frequency	No	Yes
Pn40D	2nd Notch Filter Q Value	No	Yes
Pn140	Model Following Control Related Switch	Yes	Yes
Pn141	Model Following Control Gain	No	Yes
Pn142	Model Following Control Gain Compensation	No	Yes
Pn143	Model Following Control Bias (Forward Direction)	No	Yes
Pn144	Model Following Control Bias (Reverse Direction)	No	Yes
Pn145	Vibration Suppression 1 Frequency A	No	No
Pn146	Vibration Suppression 1 Frequency B	No	No
Pn147	Model Following Control Speed Feedforward Compensation	No	Yes
Pn160	Anti-Resonance Control Related Switch	Yes	Yes
Pn161	Anti-Resonance Frequency	No	Yes
Pn163	Anti-Resonance Damping Gain	No	Yes

6.6 Anti-Resonance Control Adjustment Function (Fn204)

This section describes the anti-resonance control adjustment function.

6.6.1 Anti-Resonance Control Adjustment Function

The anti-resonance control adjustment function increases the effectiveness of the vibration suppression after one-parameter tuning. This function is effective in supporting anti-resonance control adjustment if the vibration frequencies are from 100 to 1000 Hz.

This function rarely needs to be used because it is automatically set by the advanced autotuning or advanced autotuning by reference input. Use this function only if fine-tuning is required, or vibration detection is failed and readjustment is required.

Perform one-parameter tuning (Fn203) or use another method to improve the response characteristics after performing this function. If the anti-resonance gain is increased with one-parameter tuning performed, vibration may result again. If that occurs, perform this function again to fine-tune the settings.

CAUTION

- If this function is executed, related parameters will be set automatically. Therefore, there will be a large response change after this function is executed. Enable the function in a state where the machine can come to an emergency stop at any time to ensure the safety operation of the machine.
- Be sure to set a suitable value for the moment of inertia ratio (Pn103) using advanced autotuning before executing the anti-resonance control adjustment function. If the setting greatly differs from the actual moment of inertia ratio, normal control of the machine may not be possible, and vibration may result.



IMPORTANT

- This function detects vibration between 100 and 1000 Hz. Vibration will not be detected for frequencies outside of this range, and instead, "F----" will be displayed. If that occurs, use one-parameter tuning with tuning mode 2 selected to automatically set a notch filter or use the vibration suppression function (Fn205).
- Vibration can be reduced more effectively by increasing the anti-resonance damping gain (Pn163). The amplitude of vibration may become larger if the damping gain is excessively high. Increase the damping gain from about 0% to 200% in 10% increments while checking the effect of vibration reduction. If the effect of vibration reduction is still insufficient at a gain of 200%, cancel the setting, and lower the control gain using a different method, such as one-parameter tuning.











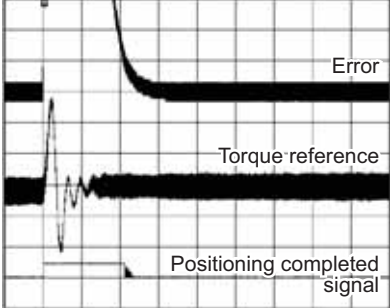









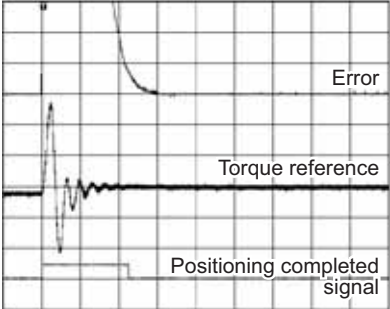



(1) Before Performing Anti-Resonance Control Adjustment Function

Check the following settings before performing anti-resonance control adjustment function.























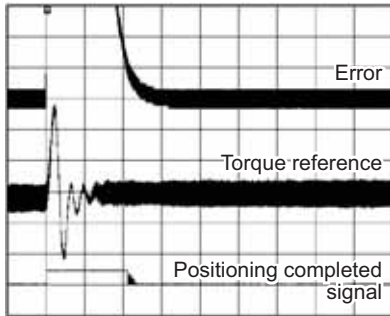

The message "NO-OP" indicating that the settings are not appropriate will be displayed, if all of the following conditions are not met.

- The tuning-less function must be disabled (Pn170.0 = 0).
- The test without a motor function must be disabled (Pn00C.0 = 0).
- The control must not be set to torque control.
- The write prohibited setting parameter (Fn010) must be set to Write permitted (P.0000).

(cont'd)

Step	Display after Operation	Keys	Operation
5	<pre> RUN - Vib Sup - freq = 0400 Hz damp = 0000 </pre>		<p>The vibration frequency will be displayed in "freq" if vibration is detected.</p>  <p>Example of measured waveform</p>
6	<pre> RUN - Vib Sup - freq = 0400 Hz damp = 0000 </pre>		<p>Press the  Key. The cursor will move to "damp," and the flashing of "freq" will stop.</p>
7	<pre> RUN - Vib Sup - freq = 0400 Hz damp = 0120 </pre>	   	<p>Select the digit with the  or  Key, and press the  or  Key to set the damping gain.</p>  <p>Example of measured waveform</p> <p>Note: Increase the damping gain from about 0% to 200% in 10% increments while checking the effect of vibration reduction. If vibration reduction is still insufficient at a gain of 200%, cancel the setting, and lower the control gain by using a different method, such as one-parameter tuning.</p>
8	<pre> RUN - Vib Sup - freq = 0400 Hz damp = 0120 </pre>		<p>If fine tuning of the frequency is necessary, press the  Key. The cursor will move from "damp" to "freq." If fine-tuning is not necessary, skip step 9 and go to step 10.</p>
9	<pre> RUN - Vib Sup - freq = 0420 Hz damp = 0120 </pre>	   	<p>Select the digit with the  or  Key, and press the  or  Key to fine-tune the frequency.</p>
10	<pre> RUN - Vib Sup - freq = 0420 Hz damp = 0120 </pre>		<p>Press the  Key to save the settings. "DONE" will flash for approximately two seconds and "RUN" will be displayed.</p>
11	<pre> RUN -FUNCTION- Fn203: OnePrmTun Fn204: A-Vib Sup Fn205: Vib Sup Fn206: Easy FFT </pre>		<p>Press the  Key to complete the anti-resonance control adjustment function. The screen in step 1 will appear again.</p>

■ With Determined Vibration Frequency

Step	Display after Operation	Keys	Operation
1	<pre> RUN -FUNCTION- Fn203:OnePrmTun Fn204:A-Vib Sup Fn205:Vib Sup Fn206:Easy FFT </pre>	  	<p>Press the  Key to view the main menu for the utility function.</p> <p>Use the  or  Key to move through the list, select Fn204.</p>
2	<pre> RUN -Vib Sup- Tuning Mode = 0 </pre>		<p>Press the  Key to display the initial setting screen for tuning mode.</p>
3	<pre> RUN -FUNCTION- Tuning Mode = 1 </pre>	 	<p>Press the  or  Key and set the tuning mode "1."</p>
4	<pre> RUN -Vib Sup- freq = 0100 Hz damp = 0000 </pre>		<p>Press the  Key while "Tuning Mode = 1" is displayed. The screen shown on the left will appear and "freq" will flash.</p>  <p>Example of measured waveform</p>
5	<pre> RUN -Vib Sup- freq = 0100 Hz damp = 0000 </pre>	   	<p>Select the digit with the  or  Key, and press the  or  Key to adjust the frequency.</p>
6	<pre> RUN -Vib Sup- freq = 0400 Hz damp = 000<u>0</u> </pre>		<p>Press the  Key. The cursor will move to "damp."</p>























(cont'd)

Step	Display after Operation	Keys	Operation
7	<pre> RUN - Vib Sup - freq = 0400 Hz damp = 0020 </pre>		<p>Select the digit with the or Key, and press the or Key to adjust the damping gain.</p> <p>Example of measured waveform</p> <p>Note: Increase the damping gain from about 0% to 200% in 10% increments while checking the effect of vibration reduction. If vibration reduction is still insufficient at a gain of 200%, cancel the setting, and lower the control gain by using a different method, such as one-parameter tuning.</p>
8	<pre> RUN - Vib Sup - freq = 0400 Hz damp = 0120 </pre>		<p>If fine tuning of the frequency is necessary, press the Key. The cursor will move from "damp" to "freq." If fine-tuning is not necessary, skip step 9 and go to step 10.</p>
9	<pre> RUN - Vib Sup - freq = 0400 Hz damp = 0120 </pre>		<p>Select the digit with the or Key, and press the or Key to fine-tune the frequency.</p>
10	<pre> RUN - Vib Sup - freq = 0400 Hz damp = 0120 </pre>		<p>Press the Key to save the settings. "DONE" will flash for approximately two seconds and "RUN" will be displayed.</p>
11	<pre> RUN -FUNCTION- Fn203: OnePrmTun Fn204: A-Vib Sup Fn205: Vib Sup Fn206: Easy FFT </pre>		<p>Press the Key to complete the anti-resonance control adjustment function. The screen in step 1 will appear again.</p>

(2) For Fine-tuning After Adjusting the Anti-Resonance Control

Step	Display after Operation	Keys	Operation
1	<pre> RUN -FUNCTION- Fn203: OnePrmTun Fn204: A-Vib Sup Fn205: Vib Sup Fn206: Easy FFT </pre>	 	<p>Press the Key to view the main menu for the utility function.</p> <p>Use the or Key to move through the list, select Fn204.</p>
2	<pre> RUN -FUNCTION- Tuning Mode = 1 </pre>		<p>Press the Key to display the "Tuning Mode = 1" as shown on the left.</p>
3	<pre> RUN - Vib Sup - freq = 0400 Hz damp = 0120 </pre>		<p>Press the Key while "Tuning Mode = 1" is displayed. The screen shown on the left will appear and "damp" will flash.</p>

(cont'd)

Step	Display after Operation	Keys	Operation
4	<pre> RUN - V i b S u p - freq = 0400 Hz damp = 01<u>5</u>0 </pre>	   	Select the digit with the  or  Key, and press the  or  Key to set the damping gain. Note: Increase the damping gain from about 0% to 200% in 10% increments while checking the effect of vibration reduction. If vibration reduction is still insufficient at a gain of 200%, cancel the setting, and lower the control gain by using a different method, such as one-parameter tuning.
5	<pre> RUN - V i b S u p - freq = 040<u>0</u> Hz damp = 0150 </pre>		If fine tuning of the frequency is necessary, press the  Key. The cursor will move from "damp" to "freq." If fine-tuning is not necessary, skip step 6 and go to step 7.
6	<pre> RUN - V i b S u p - freq = 04<u>2</u>0 Hz damp = 0150 </pre>	   	Select the digit with the  or  Key, and press the  or  Key to fine-tune the frequency.
7	<pre> RUN - V i b S u p - freq = 0420 Hz damp = 015<u>0</u> </pre>		Press the  Key to save the settings. "DONE" will flash for approximately two seconds and "RUN" will be displayed.
8	<pre> RUN -FUNCTION- Fn203: OnePrmTun Fn204: A-Vib Sup Fn205: Vib Sup Fn206: Easy FFT </pre>		Press the  Key to complete the anti-resonance control adjustment function. The screen in step 1 will appear again.

6.6.3 Related Parameters

The following table lists parameters related to this function and their possibility of being changed while executing this function or of being changed automatically after executing this function.

- Parameters related to this function
 - These are parameters that are used or referenced when executing this function.
- Allowed changes during execution of this function
 - Yes : Parameters can be changed using SigmaWin+ while this function is being executed.
 - No : Parameters cannot be changed using SigmaWin+ while this function is being executed.
- Automatic changes after execution of this function
 - Yes : Parameter set values are automatically set or adjusted after execution of this function.
 - No : Parameter set values are not automatically set or adjusted after execution of this function.

Parameter	Name	Mid-execution changes	Automatic changes
Pn160	Anti-Resonance Control Related Switch	Yes	Yes
Pn161	Anti-Resonance Frequency	No	Yes
Pn162	Anti-Resonance Gain Compensation	Yes	No
Pn163	Anti-Resonance Damping Gain	No	Yes
Pn164	Anti-Resonance Filter Time Constant 1 Compensation	Yes	No
Pn165	Anti-Resonance Filter Time Constant 2 Compensation	Yes	No

6.7 Vibration Suppression Function (Fn205)

The vibration suppression function is described in this section.

6.7.1 Vibration Suppression Function

The vibration suppression function suppresses transitional vibration at frequency as low as 1 to 100 Hz that is generated mainly when positioning if the machine stand vibrates.

This function is set automatically when advanced autotuning or advanced autotuning by reference is executed. In most cases, this function is not necessary. Use this function only if fine-tuning is required or readjustment is required as a result of a failure to detect vibration.

Perform one-parameter tuning (Fn203) if required to improve the response characteristics after performing this function.

CAUTION

- If this function is executed, related parameters will be set automatically. Therefore, there will be a large response change after this function is enabled or disabled. Enable the function in a state where the machine can come to an emergency stop at any time to ensure the safety operation of the machine.
- Be sure to set a suitable value for the moment of inertia ratio (Pn103) using advanced autotuning before executing the vibration suppression function. If the setting greatly differs from the actual moment of inertia ratio, normal control of the SERVOPACK may not be possible, and vibration may result.



IMPORTANT

- This function detects vibration frequency between 1 to 100 Hz. Vibration will not be detected for frequencies outside of this range, and instead, "F-----" will be displayed.
- Frequency detection will not be performed if no vibration results from position error or the vibration frequencies are outside the range of detectable frequencies. If so, use a device, such as a displacement sensor or vibration sensor, to measure the vibration frequency.
- If vibration frequencies automatically detected are not suppressed, the actual frequency and the detected frequency may differ. Fine-tune the detected frequency if necessary.

(1) Preparation

Check the following settings before performing the vibration suppression function.

The message "NO-OP" indicating that the settings are not appropriate will be displayed, if all of the following conditions are not met.

- The control must be set to position control.
- The tuning-less function must be disabled (Pn170.0 = 0).
- The test without a motor function must be disabled (Pn00C.0 = 0).
- The write prohibited setting parameter (Fn010) must be set to Write permitted (P.0000).

(2) Items Influencing Performance

If continuous vibration occurs when the servomotor is not rotating, the vibration suppression function cannot be used to suppress the vibration effectively. If the result is not satisfactory, perform anti-resonance control adjustment function (Fn204) or one-parameter tuning (Fn203).

(3) Detection of Vibration Frequencies

No frequency detection may be possible if the vibration does not appear as a position error or the vibration resulting from the position error is too small.

The detection sensitivity can be adjusted by changing the setting for the remained vibration detection width (Pn560) which is set as a percentage of the positioning completed width (Pn522). Perform the detection of vibration frequencies again after adjusting the remained vibration detection width (Pn560).

Pn560	Remained Vibration Detection Width Position				Classification
	Setting Range	Setting Unit	Factory Setting	When Enabled	
	1 to 3000	0.1%	400	Immediately	Setup

Note: As a guideline, change the setting 10% at a time. The smaller the set value is, the higher the detection sensitivity will be. If the value is too small, however, the vibration may not be detected accurately.

The vibration frequencies that are automatically detected may vary somewhat with each positioning operation. Perform positioning several times and make adjustments while checking the effect of vibration suppression.

6.7.2 Vibration Suppression Function Operating Procedure

The following procedure is used for vibration suppression function.

Vibration suppression function is performed from the digital operator (option) or SigmaWin+. This function cannot be performed from the panel operator.

The operating procedure from the digital operator is described here.

Refer to the *ΣV Series User's Manual, Operation of Digital Operator* (No.: SIEP S800000 55) for basic key operations of the digital operator.







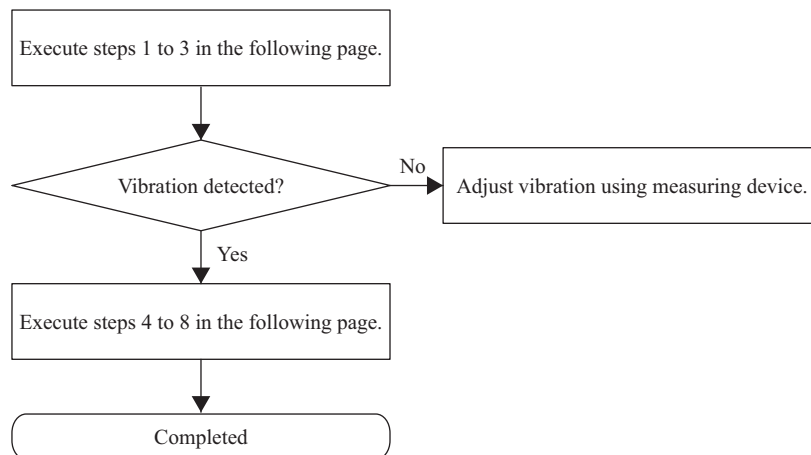









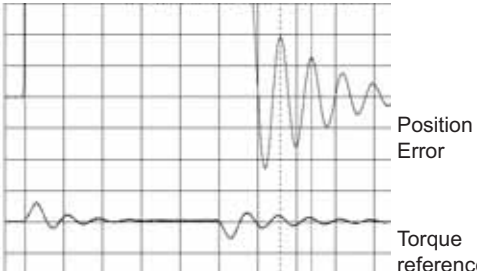

Note: If this function is aborted by pressing the MODE/SET Key, the SERVOPACK will continue operating until the servomotor comes to a stop. After the servomotor stops, the set value will return to the previous value.

The operating flow of the vibration suppression function is shown below.







(1) Operating Flow

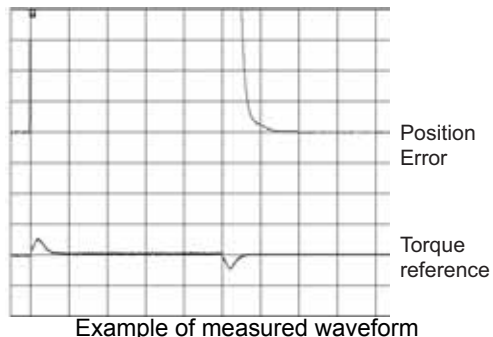

(2) Operating Procedure

Step	Display after Operation	Keys	Operation
1			Input a operation reference and take the following steps while repeating positioning.
2	<pre> RUN -FUNCTION- Fn204:A-Vib Sup Fn205:Vib Sup Fn206:Easy FFT Fn207:V-Monitor </pre>	  	<p>Press the  Key to view the main menu for the utility function.</p> <p>Use the  or  Key to move through the list, select Fn205.</p>
3	<pre> RUN -Vib Sup- Measure f=010.4Hz Setting f=050.4Hz </pre>		<p>Press the  Key. The display shown on the left will appear.</p> <p>Measure f: Measurement frequency Setting f: Setting frequency [Factory-set to the set value for Pn145]</p> <p>If the setting frequency and actual operating frequency are different, "Setting" will flash.</p> <p>Note: Frequency detection will not be performed if there is no vibration or the vibration frequency is outside the range of detectable frequencies. The following screen will be displayed if vibration is not detected. If the vibration frequencies are not detected, prepare a means of detecting and measuring the vibration. When the vibration frequencies are measured, go to step 5 and manually set the measured vibration frequency to "Setting f."</p> <pre> RUN -Vib Sup- Measure f=-----Hz Setting f=050.0Hz </pre>
4	<pre> RUN -Vib Sup- Measure f=010.4Hz Setting f=010.4Hz </pre>		<p>Press the  Key. The displayed "Measure f" value will be displayed as the "Setting f" value as well.</p>  <p>Example of measured waveform</p>
5	<pre> RUN -Vib Sup- Measure f=010.4Hz Setting f=012.4Hz </pre>	   	<p>If the vibration is not completely suppressed, select the digit with the  or  Key, and press the  or  Key to fine-tune the frequency "setting f." Skip this step and go to step 7 if the fine-tuning of the frequency is not necessary.</p> <p>Note: If the setting frequency and actual operating frequency are different, "Setting" will flash.</p>

(cont'd)

Step	Display after Operation	Keys	Operation
6	<pre> RUN -Vib Sup- Measure f=010.4Hz Setting f=012.4Hz </pre>		<p>Press the  Key. The "Setting f" will change to usual display and the frequency currently displayed will be set for the vibration suppression function.</p>  <p>Example of measured waveform</p>
7	<pre> RUN -Vib Sup- Measure f=-----Hz Setting f=012.4Hz </pre>		<p>Press the  Key to save the setting. "DONE" will flash for approximately two seconds and "RUN" will be displayed again.</p>
8	<pre> RUN -FUNCTION- Fn204 Fn205 Fn206 Fn207 </pre>		<p>Press the  Key to complete the vibration suppression function. The screen in step 1 will appear again.</p>



IMPORTANT

No settings related to the vibration suppression function will be changed during operation.

If the servomotor does not stop approximately 10 seconds after the setting changes, a timeout error will result and the previous setting will be automatically enabled again.

The vibration suppression function will be enabled in step 6. The motor response, however, will change when the servomotor comes to a stop with no reference input.

(3) Related Function on Vibration Suppression Function

This section describes functions related to vibration suppression function.

■ Feedforward

The feedforward gain (Pn109), speed feedforward (V-REF) input, and torque feedforward (T-REF) input will be disabled in the factory setting.

Set Pn140.3 to 1 if model following control is used together with the speed feedforward (V-REF) input and torque feedforward (T-REF) input from the host controller.

Parameter	Function	When Enabled	Classification
Pn140	n.0□□□ [Factory setting]	Immediately	Tuning
	n.1□□□		

Refer to 6.9.2 *Torque Feedforward* and 6.9.3 *Speed Feedforward* for details.



IMPORTANT

- Model following control is used to make optimum feedforward settings in the SERVO-PACK when model following control is used with the feedforward function. Therefore, model following control is not normally used together with either the speed feedforward (V-REF) input or torque feedforward (T-REF) input from the host controller. However, model following control can be used with the speed feedforward (V-REF) input or torque feedforward (T-REF) input if required. An improper feedforward input may result in overshooting.

6.7.3 Related Parameters

The following table lists parameters related to this function and their possibility of being changed while executing this function or of being changed automatically after executing this function.

- Parameters related to this function

These are parameters that are used or referenced when executing this function.

- Allowed changes during execution of this function

Yes : Parameters can be changed using SigmaWin+ while this function is being executed.

No : Parameters cannot be changed using SigmaWin+ while this function is being executed.

- Automatic changes after execution of this function

Yes : Parameter set values are automatically set or adjusted after execution of this function.

No : Parameter set values are not automatically set or adjusted after execution of this function.

Parameter	Name	Mid-execution changes	Automatic changes
Pn140	Model Following Control Related Switch	Yes	Yes
Pn141	Model Following Control Gain	No	Yes
Pn142	Model Following Control Gain Compensation	No	No
Pn143	Model Following Control Bias (Forward Direction)	No	No
Pn144	Model Following Control Bias (Reverse Direction)	No	No
Pn145	Vibration Suppression 1 Frequency A	No	Yes
Pn146	Vibration Suppression 1 Frequency B	No	Yes
Pn147	Model Following Control Speed Feedforward Compensation	No	No
Pn14A	Vibration Suppression 2 Frequency	No	No
Pn14B	Vibration Suppression 2 Compensation	No	No

6.8 Additional Adjustment Function

This section describes the functions that can be used for additional fine tuning after making adjustments with advanced autotuning, advanced autotuning by reference, or one-parameter tuning.

- Switching gain settings
- Friction compensation
- Current control mode selection
- Current gain level setting
- Speed detection method selection

6.8.1 Switching Gain Settings

Two gain switching functions are available, manual switching and automatic switching. The manual switching function uses an external input signal to switch gains, and the automatic switching function switches gains automatically.

By using the gain switching function, the positioning time can be shortened by increasing the gain during positioning and vibration can be suppressed by decreasing the gain while it is stopped.

Parameter		Function	When Enabled	Classification
Pn139	n.□□□0 [Factory setting]	Manual gain switching	Immediately	Tuning
	n.□□□2	Automatic gain switching		

Note: n.□□□1 is reserved. Do not use.

For the gain combinations for switching, refer to (1) *Gain Combinations for Switching*.

For the manual gain switching, refer to (2) *Manual Gain Switching*.

For the automatic gain switching, refer to (3) *Automatic Gain Switching*.

(1) Gain Combinations for Switching

Setting	Speed Loop Gain	Speed Loop Integral Time Constant	Position Loop Gain	Torque Reference Filter	Model Following Control Gain	Model Following Control Gain Compensation	Friction Compensation Gain
Gain Setting 1	Pn100 Speed Loop Gain	Pn101 Speed Loop Integral Time Constant	Pn102 Position Loop Gain	Pn401 Torque Reference Filter Time Constant	Pn141* Model Following Control Gain	Pn142* Model Following Control Gain Compensation	Pn121 Friction Compensation Gain
Gain Setting 2	Pn104 2nd Speed Loop Gain	Pn105 2nd Speed Loop Integral Time Constant	Pn106 2nd Position Loop Gain	Pn412 1st Step 2nd Torque Reference Filter Time Constant	Pn148* 2nd Model Following Control Gain	Pn149* 2nd Model Following Control Gain Compensation	Pn122 2nd Gain for Friction Compensation

* The switching gain settings for the model following control gain and the model following control gain compensation are available only for manual gain switching. To enable the gain switching of these parameters, a gain switching input signal must be sent, and the following conditions must be met.

- No command being executed.
- Motor having been completely stopped.

If these conditions are not satisfied, the applicable parameters will not be switched although the other parameters shown in this table will be switched.

(2) Manual Gain Switching

Manual gain switching uses an external input signal (/G-SEL) to switch between gain setting 1 and gain setting 2.

Type	Signal Name	Connector Pin Number	Setting	Meaning
Input	/G-SEL	Must be allocated	OFF	Switches to gain setting 1.
			ON	Switches to gain setting 2.

(3) Automatic Gain Switching

Automatic gain switching is enabled only in position control. The switching conditions are specified using the following settings.

Parameter Setting	Switching Condition	Setting	Switching Wait Time	Switching Time	
Pn139	n.□□□2	Condition A satisfied.	Gain setting 1 to gain setting 2	Pn135 Gain Switching Waiting Time 1	Pn131 Gain Switching Time 1
		Condition A not satisfied.	Gain setting 2 to gain setting 1	Pn136 Gain Switching Waiting Time 2	Pn132 Gain Switching Time 2

Select one of the following settings for switching condition A.

Parameter	Switching Condition A for Position Control	For Other than Position Control (No Switching)	When Enabled	Classification	
Pn139	n.□□0□ [Factory setting]	Positioning completed signal (/COIN) ON	Fixed in gain setting 1	Immediately	Tuning
	n.□□1□	Positioning completed signal (/COIN) OFF	Fixed in gain setting 2		
	n.□□2□	Positioning near signal (/NEAR) ON	Fixed in gain setting 1		
	n.□□3□	Positioning near signal (/NEAR) OFF	Fixed in gain setting 2		
	n.□□4□	No output for position reference filter and reference pulse input OFF	Fixed in gain setting 1		
	n.□□5□	Position reference pulse input ON	Fixed in gain setting 2		

Automatic switching pattern 1 (Pn139.0 = 2)

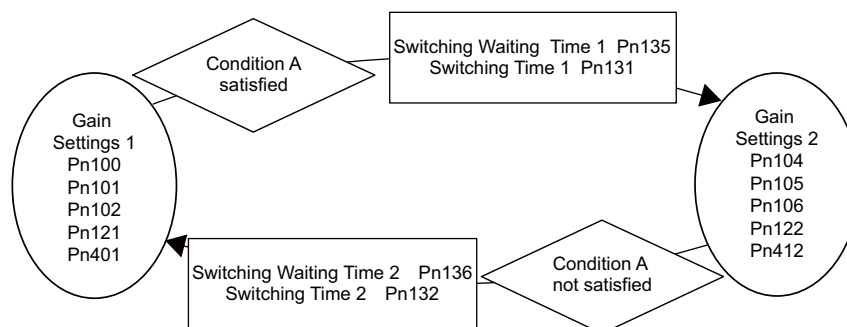

■ Relationship between the Waiting and Switching Times for Gain Switching

In this example, the "positioning completed signal (/COIN) ON" condition is set as condition A for automatic gain switching. The position loop gain is switched from the value in Pn102 (position loop gain) to the value in Pn106 (2nd position loop gain). When the /COIN signal goes ON, the switching operation begins after the waiting time set in Pn135. The switching operation changes the position loop gain linearly from Pn102 to Pn106 within the switching time set in Pn131.

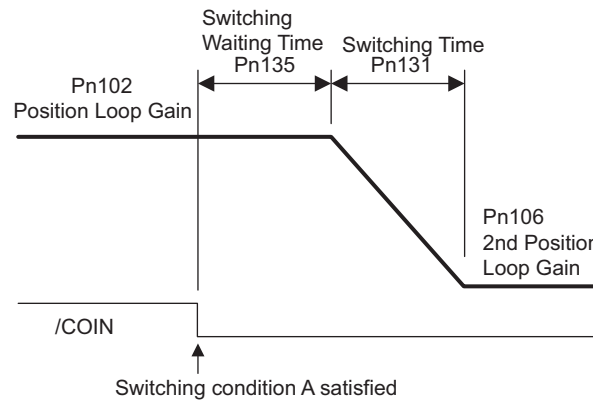

Note: Automatic gain switching is available in the PI and I-P controls (Pn10B).

(4) Related Parameters

Pn100	Speed Loop Gain Speed <input type="checkbox"/> Position <input type="checkbox"/>				Classification
	Setting Range	Setting Unit	Factory Setting	When Enabled	
	10 to 20000	0.1 Hz	400	Immediately	Tuning
Pn101	Speed Loop Integral Time Constant Speed <input type="checkbox"/> Position <input type="checkbox"/>				Classification
	Setting Range	Setting Unit	Factory Setting	When Enabled	
	15 to 51200	0.01 ms	2000	Immediately	Tuning
Pn102	Position Loop Gain Position <input type="checkbox"/>				Classification
	Setting Range	Setting Unit	Factory Setting	When Enabled	
	10 to 20000	0.1/s	400	Immediately	Tuning
Pn401	Torque Reference Filter Time Constant Speed <input type="checkbox"/> Position <input type="checkbox"/> Torque <input type="checkbox"/>				Classification
	Setting Range	Setting Unit	Factory Setting	When Enabled	
	0 to 65535	0.01 ms	100	Immediately	Tuning
Pn141	Model Following Control Gain Position <input type="checkbox"/>				Classification
	Setting Range	Setting Unit	Factory Setting	When Enabled	
	10 to 20000	0.1/s	500	Immediately	Tuning
Pn142	Model Following Control Gain Compensation Position <input type="checkbox"/>				Classification
	Setting Range	Setting Unit	Factory Setting	When Enabled	
	500 to 2000	0.1%	1000	Immediately	Tuning
Pn121	Friction Compensation Gain Speed <input type="checkbox"/> Position <input type="checkbox"/>				Classification
	Setting Range	Setting Unit	Factory Setting	When Enabled	
	10 to 1000	1%	100	Immediately	Tuning
Pn104	2nd Speed Loop Gain Speed <input type="checkbox"/> Position <input type="checkbox"/>				Classification
	Setting Range	Setting Unit	Factory Setting	When Enabled	
	10 to 20000	0.1 Hz	400	Immediately	Tuning

(cont'd)

Pn105	2nd Speed Loop Integral Time Constant				Speed	Position	Classification	
	Setting Range	Setting Unit	Factory Setting	When Enabled				
	15 to 51200	0.01 ms	2000	Immediately		Tuning		
Pn106	2nd Position Loop Gain					Position	Classification	
	Setting Range	Setting Unit	Factory Setting	When Enabled				
	10 to 20000	0.1/s	400	Immediately		Tuning		
Pn412	1st Step 2nd Torque Reference Filter Time Constant				Speed	Position	Torque	Classification
	Setting Range	Setting Unit	Factory Setting	When Enabled				
	0 to 65535	0.01 ms	100	Immediately		Tuning		
Pn148	2nd Model Following Control Gain					Position	Classification	
	Setting Range	Setting Unit	Factory Setting	When Enabled				
	10 to 20000	0.1/s	500	Immediately		Tuning		
Pn149	2nd Model Following Control Gain Compensation					Position	Classification	
	Setting Range	Setting Unit	Factory Setting	When Enabled				
	500 to 2000	0.1%	1000	Immediately		Tuning		
Pn122	2nd Gain for Friction Compensation				Speed	Position	Classification	
	Setting Range	Setting Unit	Factory Setting	When Enabled				
	10 to 1000	1%	100	Immediately		Tuning		

(5) Parameters for Automatic Gain Switching

Pn131	Gain Switching Time 1					Position	Classification
	Setting Range	Setting Unit	Factory Setting	When Enabled			
	0 to 65535	1 ms	0	Immediately		Tuning	
Pn132	Gain Switching Time 2					Position	Classification
	Setting Range	Setting Unit	Factory Setting	When Enabled			
	0 to 65535	1 ms	0	Immediately		Tuning	
Pn135	Gain Switching Waiting Time 1					Position	Classification
	Setting Range	Setting Unit	Factory Setting	When Enabled			
	0 to 65535	1 ms	0	Immediately		Tuning	
Pn136	Gain Switching Waiting Time 2					Position	Classification
	Setting Range	Setting Unit	Factory Setting	When Enabled			
	0 to 65535	1 ms	0	Immediately		Tuning	

(6) Related Monitor

Monitor No. (Un)	Name	Value	Remarks
Un014	Effective gain monitor	1	For gain setting 1
		2	For gain setting 2

Note: When using the tuning-less function, gain setting 1 is enabled.

Parameter No.	Analog Monitor	Name	Output Value	Remarks
Pn006 Pn007	n.□□0B	Effective gain monitor	1 V	Gain setting 1 is enabled.
			2 V	Gain setting 2 is enabled.

6.8.2 Manual Adjustment of Friction Compensation

Friction compensation rectifies the viscous friction change and regular load change.

The friction compensation function can be automatically adjusted with advanced autotuning (Fn201), advanced autotuning by reference input (Fn202), or one-parameter tuning (Fn203). This section describes the steps to follow if manual adjustment is required.

(1) Required Parameter Settings

The following parameter settings are required to use friction compensation.

Parameter		Function			When Enabled	Classification
Pn408	n.0□□□ [Factory setting]	Does not use friction compensation.			Immediately	Setup
	n.1□□□	Uses friction compensation.				
Pn121	Friction Compensation Gain				<input type="checkbox"/> Speed	<input type="checkbox"/> Position
	Setting Range	Setting Unit	Factory Setting	When Enabled		Classification
	10 to 1000	1%	100	Immediately		Tuning
Pn123	Friction Compensation Coefficient				<input type="checkbox"/> Speed	<input type="checkbox"/> Position
	Setting Range	Setting Unit	Factory Setting	When Enabled		Classification
	0 to 100	1%	0	Immediately		Tuning
Pn124	Friction Compensation Frequency Correction				<input type="checkbox"/> Speed	<input type="checkbox"/> Position
	Setting Range	Setting Unit	Factory Setting	When Enabled		Classification
	-10000 to 10000	0.1 Hz	0	Immediately		Tuning
Pn125	Friction Compensation Gain Correction				<input type="checkbox"/> Speed	<input type="checkbox"/> Position
	Setting Range	Setting Unit	Factory Setting	When Enabled		Classification
	1 to 1000	1%	100	Immediately		Tuning

(2) Operating Procedure for Friction Compensation

The following procedure is used for friction compensation.

CAUTION

- Before using friction compensation, set the moment of inertia ratio (Pn103) as accurately as possible. If the wrong moment of inertia ratio is set, vibration may result.

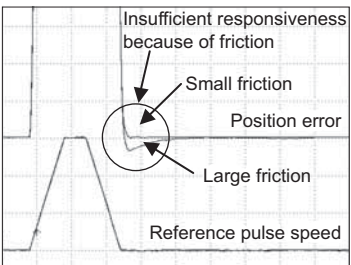
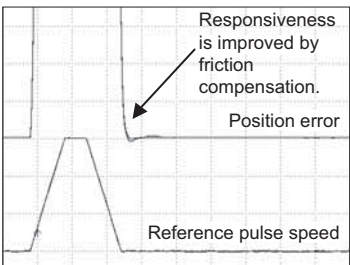
Step	Operation
1	<p>Set the following parameters for friction compensation to the factory setting as follows.</p> <p>Friction compensation gain (Pn121): 100 Friction compensation coefficient (Pn123): 0 Friction compensation frequency correction (Pn124): 0 Friction compensation gain correction (Pn125): 100</p> <p>Note: Always use the factory-set values for friction compensation frequency correction (Pn124) and friction compensation gain correction (Pn125).</p>
2	<p>To check the effect of friction compensation, gradually increase the friction compensation coefficient (Pn123). Note: Usually, set the friction compensation coefficient value to 95% or less. If the effect is insufficient, increase the friction compensation gain (Pn121) by 10% increments until it stops vibrating.</p> <p>Effect of Parameters for Adjustment</p> <p>Pn121: Friction Compensation Gain This parameter sets the responsiveness for external disturbance. The higher the set value is, the better the responsiveness will be. If the equipment has a resonance frequency, however, vibration may result if the set value is excessively high.</p> <p>Pn123: Friction Compensation Coefficient This parameter sets the effect of friction compensation. The higher the set value is, the more effective friction compensation will be. If the set value is excessively high, however, the vibration will occur easily. Usually, set the value to 95% or less.</p>
3	<p>Effect of Adjustment</p> <p>The following graph shows the responsiveness with and without proper adjustment.</p> <div style="display: flex; justify-content: space-around; align-items: flex-start;"> <div style="text-align: center;">  <p>Without friction compensation</p> </div> <div style="text-align: center;">  <p>With friction compensation</p> </div> </div>

6.8.3 Current Control Mode Selection Function

This function reduces high-frequency noises while the servomotor is being stopped. This function is enabled by default and set to be effective under different application conditions. Set Pn009.1 = 1 to use this function.

This function can be used with the following SERVOPACKs.

Input Voltage	SERVOPACK Model SGD-
200 V	120A, 180A, 200A, 330A, 470A, 550A, 590A, 780A
400 V	3R5D, 5R4D, 8R4D, 120D, 170D, 210D, 260D, 280D, 370D

Parameter	Meaning	When Enabled	Classification
Pn009	n. □□□□	After restart	Tuning
	n. □□1□ [Factory setting]		

	<ul style="list-style-type: none"> If current control mode 2 is selected, the load ratio may increase while the servomotor is being stopped.
IMPORTANT	

6.8.4 Current Gain Level Setting

This function reduces noises by adjusting the parameter value for current control inside the SERVOPACK according to the speed loop gain (Pn100). The noise level can be reduced by reducing the current gain level (Pn13D) from its factory setting of 2000% (disabled). If the set value of Pn13D is decreased, the level of noise will be lowered, but the response characteristics of the SERVOPACK will also be degraded. Adjust the current gain level within the allowable range at which SERVOPACK response characteristics can be secured. This function is always disabled in torque control (Pn000.1 = 2).

Pn13D	Current Gain Level				Classification
			Speed	Position	
	Setting Range	Setting Unit	Factory Setting	When Enabled	
	100 to 2000	1%	2000	Immediately	Tuning

	<ul style="list-style-type: none"> If the parameter setting of the current gain level is changed, the responses characteristics of the speed loop will also change. The SERVOPACK must, therefore, be readjusted again.
IMPORTANT	

6.8.5 Speed Detection Method Selection

This function can ensure smooth movement of the servomotor while the servomotor is running. Set the value of Pn009.2 to 1 and select speed detection 2 to smooth the movement of the servomotor while the servomotor is running.

Parameter	Meaning	When Enabled	Classification
Pn009	n. □0□□ [Factory setting]	After restart	Tuning
	n. □1□□		

	<ul style="list-style-type: none"> If the speed detection method is changed, the response characteristics of the speed loop will change and the SERVOPACK must be readjusted again.
IMPORTANT	

■ SERVOPACK in Position Control

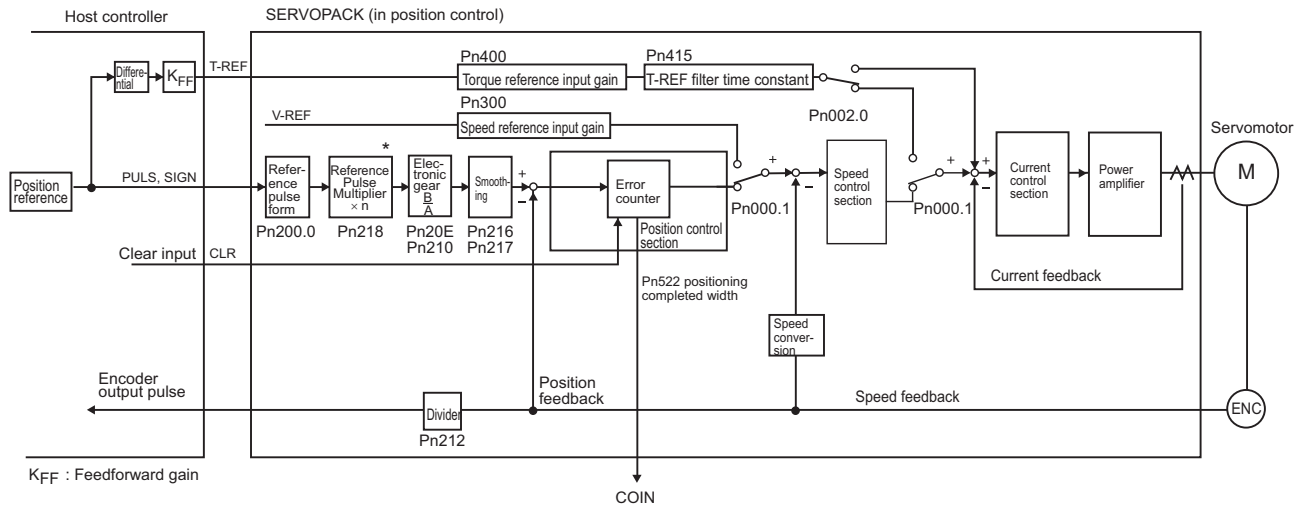

* The reference pulse input multiplication switching function is supported by software version 001A or later.

(2) Related Parameters

Torque feedforward is set using the parameters Pn002, Pn400, and Pn415.

The factory setting is Pn400 = 3.0 V/rated torque.

For example, the torque feedforward value is ± 3 V, then, the torque is limited to $\pm 100\%$ of the rated torque.

Parameter	Meaning	When Enabled	Classification
Pn002	n.□□□0 [Factory setting]	After restart	Setup
	n.□□□2		

Pn400	Torque Reference Input Gain			Classification
	Setting Range	Setting Unit	Factory Setting	
	10 to 100	0.1 V/rated torque	30	Immediately

- Note 1. Too high a torque feedforward value will result in overshooting. To prevent such troubles, set the optimum value while observing the system responsiveness.
2. The torque feedforward function cannot be used with torque limiting by analog voltage reference.

Pn415	T-REF Filter Time Constant			Classification
	Setting Range	Setting Unit	Factory Setting	
	0 to 65535	0.01 ms	0	Immediately

6.9.3 Speed Feedforward

The speed forward function shortens positioning time.
 This function is enabled only when the SERVOPACK performs position control.

The host controller finds the difference from the position reference to generate a speed feedforward reference, and inputs the speed feedforward reference together with the position reference to the SERVOPACK.

(1) Example of Connection with Host Controller

Connect a position reference to PULS and SIGN (CN1-7, -8, -11, and -12) and a speed feedforward reference to V-REF (CN1-5 and -6) from the host controller.

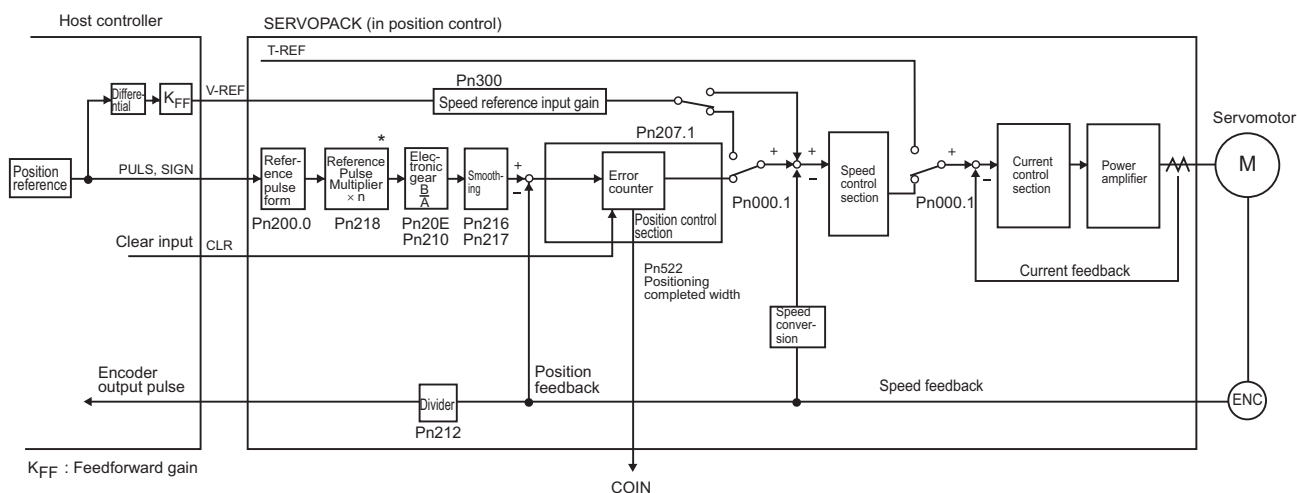

* The reference pulse input multiplication switching function is supported by software version 001A or later.

(2) Related Parameters

Speed feedforward value is set using the parameters Pn207 and Pn300.

The factory setting is Pn300 = 6.00 V/rated speed.
 For example, the speed feedforward value is ±6 V, then the speed is limited to the rated speed.

Parameter	Meaning	When Enabled	Classification
Pn207	n.□□0□ [Factory setting]	After restart	Setup
	n.□□1□		

Pn300	Speed Reference Input Gain				Classification	
			Speed	Position		Torque
	Setting Range	Setting Unit	Factory Setting	When Enabled		
	150 to 3000	0.01 V/rated speed	600	Immediately	Setup	

Note: Too high a speed feedforward value will result in overshooting. To prevent such troubles, set the optimum value while observing the system responsiveness.

6.9.4 Proportional Control

The /P-CON signal can be sent from the host control to select proportional control.

The speed control section uses a PI control if the reference stays zero in the speed control. This integral effect may cause the servomotor to move. Switch the PI control to a proportional control to prevent this from occurring.

If the speed control is set with a zero clamp function, however, a position loop will be formed so there is no need to use this function. The speed control is set to proportional control if the /P-CON signal is ON.

Proportional control operation is set using parameter Pn000.1 and input signal /P-CON.

(1) /P-CON Input Signal

Input signal /P-CON is used to switch between PI control and P control.

Type	Signal Name	Connector Pin Number	Setting	Meaning
Input	/P-CON	CN1-41 [Factory setting]	OFF (High level)	Switches to PI control (proportional-integral control).
			ON (Low level)	Switches to P control (proportional control).

Example: Factory-set Input Signal Allocations

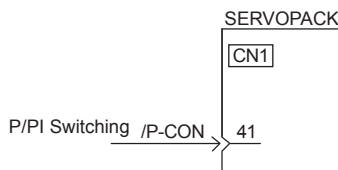

Note: This is an example when the input signal allocations are at the default factory settings.

(2) Control Method and Proportional Control Input Signal

Proportional control operation is enabled when the control method is set to speed or position control.

Parameter	Contents	Switching to the Proportional Control	
Pn000	n.□□0□ [Factory setting]	Speed control	Can be switched with the factory setting (CN1-41=/P-CON). /P-CON signal can be allocated to other terminals as required.
	n.□□1□	Position control	
	n.□□2□	Torque control	Cannot switch to proportional control.
	n.□□3□	Internal set speed control	Allocation of /P-CON to one of terminals CN1-40 to 46 are needed.
	n.□□4□	Internal set speed control ⇔ Speed control	
	n.□□5□	Internal set speed control ⇔ Position control	
	n.□□6□	Internal set speed control ⇔ Torque control	
	n.□□7□	Position control ⇔ Speed control	
	n.□□8□	Position control ⇔ Torque control	
	n.□□9□	Torque control ⇔ Speed control	
	n.□□A□	Speed control ⇔ Speed control with zero clamp function	
	n.□□B□	Position control ⇔ Position control with reference pulse inhibit function	

Note: Refer to 5.7 *Combination of Control Methods* for how to switch control methods.

6.9.5 Mode Switch (P/PI Switching)

The mode switch automatically switches between proportional and PI control. Set the switching condition with Pn10B.0 and set the level of detection points with Pn10C, Pn10D, Pn10E, and Pn10F.

Overshooting caused by acceleration and deceleration can be suppressed and the settling time can be reduced by setting the switching condition and detection points.

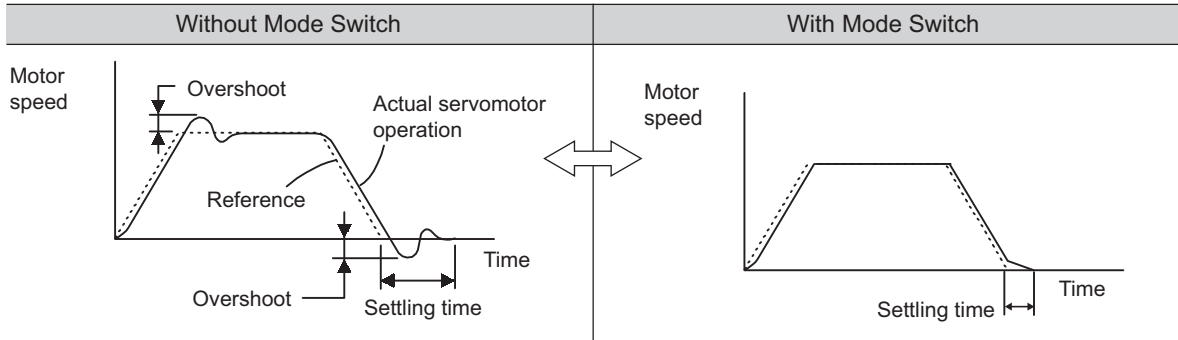

(1) Related Parameters

Select the switching condition of the mode switch with Pn10B.0.

Parameter	Mode Switch Selection	Parameter Containing Detection Point Setting	When Enabled	Classification
Pn10B	n.□□□0 [Factory setting]	Uses an internal torque reference level for the switching conditions.	Pn10C	Immediately Setup
	n.□□□1	Uses a speed reference level for the switching conditions.	Pn10D	
	n.□□□2	Uses an acceleration level for the switching conditions.	Pn10E	
	n.□□□3	Uses a position error level for the switching conditions.	Pn10F	
	n.□□□4	Does not use mode switch function.	–	

■ Parameters to Set the Level of Detection Points

Pn10C	Mode Switch (Torque Reference) <input type="checkbox"/> Speed <input type="checkbox"/> Position				Classification
	Setting Range	Setting Unit	Factory Setting	When Enabled	
	0 to 800	1%	200	Immediately	Tuning
Pn10D	Mode Switch (Speed Reference) <input type="checkbox"/> Speed <input type="checkbox"/> Position				Classification
	Setting Range	Setting Unit	Factory Setting	When Enabled	
	0 to 10000	1 min ⁻¹	0	Immediately	Tuning
Pn10E	Mode Switch (Acceleration) <input type="checkbox"/> Speed <input type="checkbox"/> Position				Classification
	Setting Range	Setting Unit	Factory Setting	When Enabled	
	0 to 30000	1 min ⁻¹ /s	0	Immediately	Tuning
Pn10F	Mode Switch (Position Error) <input type="checkbox"/> Position				Classification
	Setting Range	Setting Unit	Factory Setting	When Enabled	
	0 to 10000	1 reference unit	0	Immediately	Tuning

(2) Operating Examples for Different Switching Conditions

■ Using the Torque Reference [Factory Setting]

With this setting, the speed loop is switched to P control when the value of torque reference input exceeds the torque set in Pn10C. The factory setting for the torque reference detection point is 200% of the rated torque.

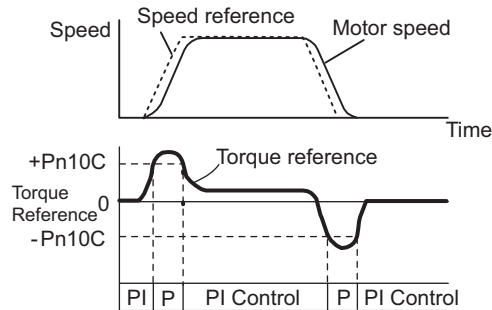

■ Using the Speed Reference

With this setting, the speed loop is switched to P control when the value of speed reference input exceeds the speed set in Pn10D.

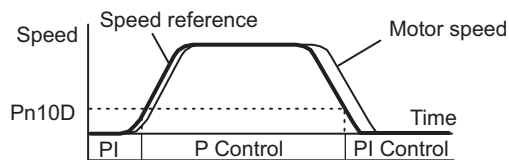

■ Using Acceleration

With this setting, the speed loop is switched to P control when the speed reference exceeds the acceleration set in Pn10E.

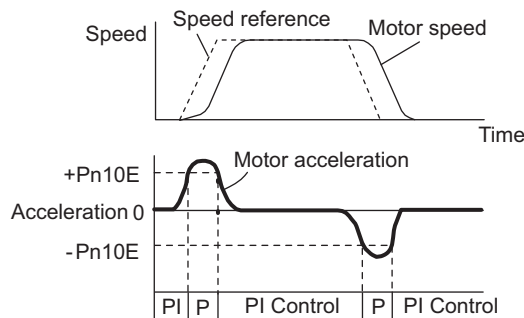

■ Using the Position Error

With this setting, the speed loop is switched to P control when the position error exceeds the value set in Pn10F.

This setting is effective with position control only.

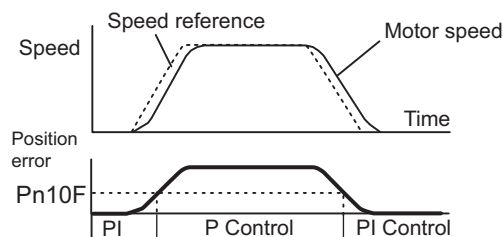

6.9.6 Torque Reference Filter

As shown in the following diagram, the torque reference filter contains first order lag filter and notch filters arrayed in series, and each filter operates independently. The notch filters can be enabled and disabled with the Pn408.

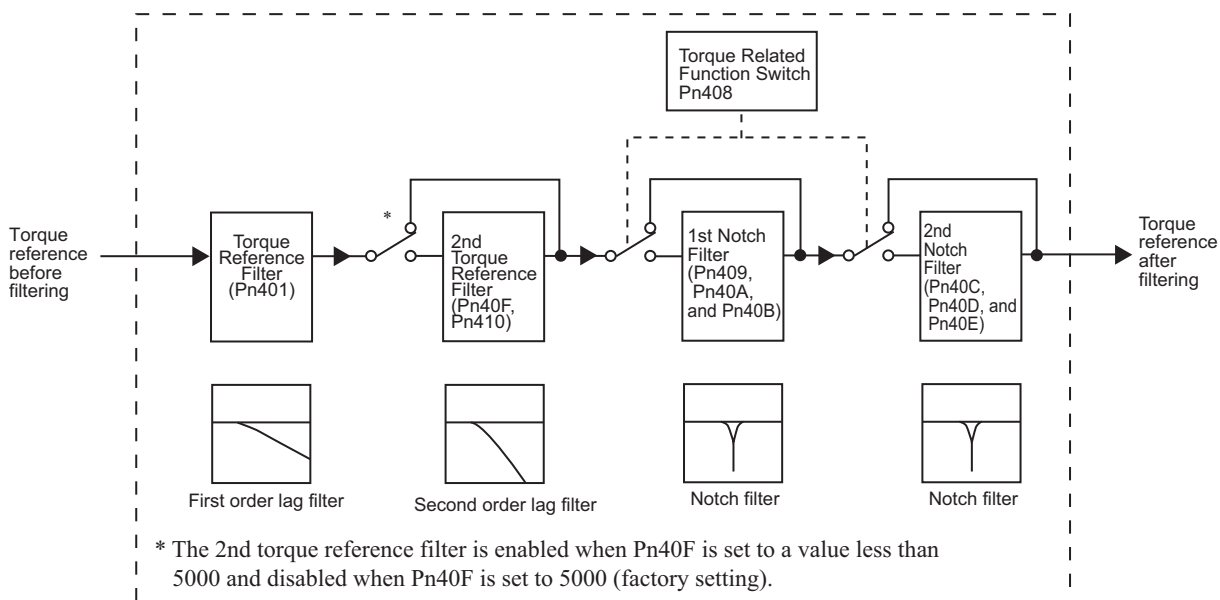

(1) Torque Reference Filter

If you suspect that machine vibration is being caused by the servo drive, try adjusting the filter time constants with Pn401. This may stop the vibration. The lower the value, the better the response will be, but there may be a limit that depends on the machine conditions.

Pn401	Torque Reference Filter Time Constant Speed Position Torque				Classification
	Setting Range	Setting Unit	Factory Setting	When Enabled	
	0 to 65535	0.01 ms	100	Immediately	

■ Torque Reference Filter Setting Guide

Use the speed loop gain (Pn100 [Hz]) and the torque filter time constant (Pn401 [ms]) to set the torque reference filter.

Adjusted value for stable control: $Pn401 [ms] \leq 1000 / (2\pi \times Pn100 [Hz] \times 4)$

Critical gains: $Pn401 [ms] < 1000 / (2\pi \times Pn100 [Hz] \times 1)$

Pn40F	2nd Step 2nd Torque Reference Filter Frequency Speed Position Torque				Classification
	Setting Range	Setting Unit	Factory Setting	When Enabled	
	100 to 5000	1 Hz	5000*	Immediately	

Pn410	2nd Step 2nd Torque Reference Filter Q Value Speed Position Torque				Classification
	Setting Range	Setting Unit	Factory Setting	When Enabled	
	50 to 100	0.01	50	Immediately	

* The filter is disabled if 5000 is set.

(2) Notch Filter

The notch filter can eliminate specific frequency elements generated by the vibration of sources such as resonance of the shaft of a ball screw. The notch filter puts a notch in the gain curve at the specific vibration frequency. The frequency characteristics near the notch can be reduced or removed with this filter. A higher Q value produces a sharper notch and phase delay.

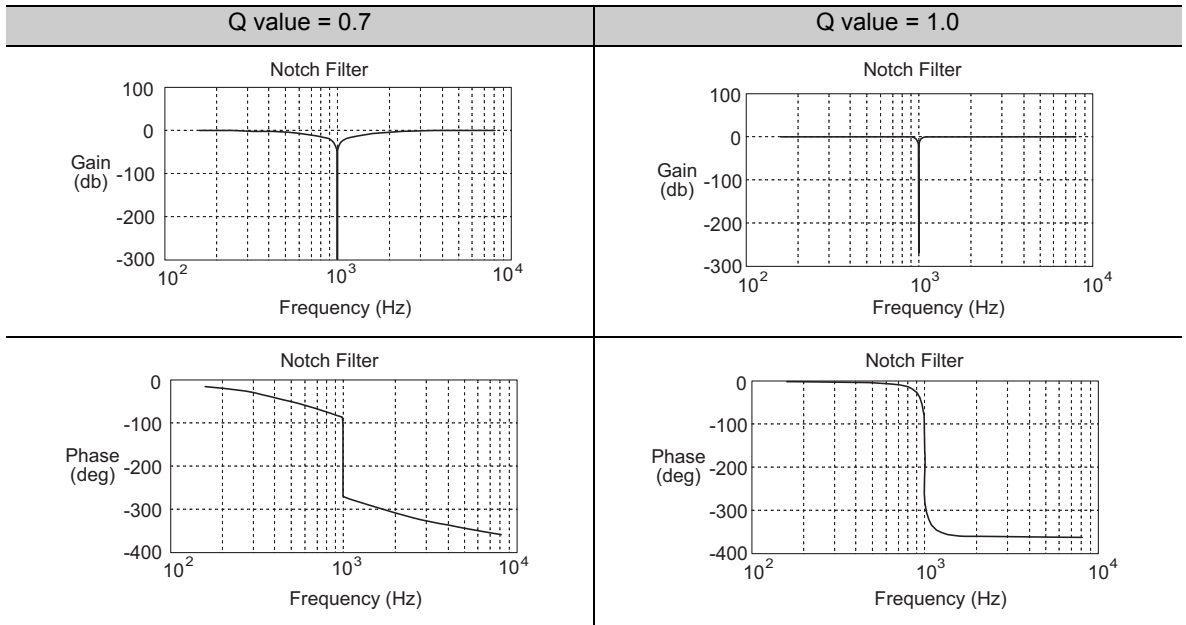

The notch filter can be enabled or disabled with Pn408.

Parameter	Meaning	When Enabled	Classification
Pn408	n.□□□0 [Factory setting]	Disables 1st notch filter.	Immediately Setup
	n.□□□1	Enables 1st notch filter.	
	n.□□□□ [Factory setting]	Disables 2nd notch filter.	
	n.□1□□	Enables 2nd notch filter.	

Set the machine's vibration frequency as a parameter of the notch filter.

Pn409	1st Notch Filter Frequency				Classification Tuning
	Setting Range	Setting Unit	Factory Setting	When Enabled	
	50 to 5000	1 Hz	5000	Immediately	
Pn40A	1st Notch Filter Q Value				Classification Tuning
	Setting Range	Setting Unit	Factory Setting	When Enabled	
	50 to 1000	0.01	70	Immediately	
Pn40B	1st Notch Filter Depth				Classification Tuning
	Setting Range	Setting Unit	Factory Setting	When Enabled	
	0 to 1000	0.001	0	Immediately	
Pn40C	2nd Notch Filter Frequency				Classification Tuning
	Setting Range	Setting Unit	Factory Setting	When Enabled	
	50 to 5000	1 Hz	5000	Immediately	

(cont'd)

Pn40D	2nd Notch Filter Q Value Speed Position Torque				Classification
	Setting Range	Setting Unit	Factory Setting	When Enabled	
	50 to 1000	0.01	70	Immediately	Tuning
Pn40E	2nd Notch Filter Depth Speed Position Torque				Classification
	Setting Range	Setting Unit	Factory Setting	When Enabled	
	0 to 1000	0.001	0	Immediately	Tuning

**IMPORTANT**

- Sufficient precautions must be taken when setting the notch filter frequencies. Do not set the notch filter frequencies (Pn409 or Pn40C) that is close to the speed loop's response frequency. Set the frequencies at least four times higher than the speed loop's response frequency. Setting the notch filter frequency too close to the response frequency may cause vibration and damage the machine.
- Change the notch filter frequencies (Pn409 or Pn40C) only when the servomotor is stopped. Vibration may occur if the notch filter frequency is changed when the servomotor is rotating.

6.9.7 Position Integral

The position integral is the integral function of the position loop. It is used for the electronic cams and electronic shafts when using the SERVOPACK with YASKAWA MP900/2000 Machine Controllers.

Pn11F	Position Integral Time Constant Position				Classification
	Setting Range	Setting Unit	Factory Setting	When Enabled	
	0 to 50000	0.1 ms	0	Immediately	Tuning

Utility Functions (Fn□□□)

7.1 List of Utility Functions	7-2
7.2 Alarm History Display (Fn000)	7-3
7.3 JOG Operation (Fn002)	7-4
7.4 Origin Search (Fn003)	7-6
7.5 Program JOG Operation (Fn004)	7-8
7.6 Initializing Parameter Settings (Fn005)	7-12
7.7 Clearing Alarm History (Fn006)	7-13
7.8 Offset Adjustment of Analog Monitor Output (Fn00C)	7-14
7.9 Gain Adjustment of Analog Monitor Output (Fn00D)	7-16
7.10 Automatic Offset-Signal Adjustment of the Motor Current Detection Signal (Fn00E)	7-18
7.11 Manual Offset-Signal Adjustment of the Motor Current Detection Signal (Fn00F)	7-19
7.12 Write Prohibited Setting (Fn010)	7-20
7.13 Servomotor Model Display (Fn011)	7-22
7.14 Software Version Display (Fn012)	7-24
7.15 Resetting Configuration Errors in Option Modules (Fn014)	7-25
7.16 Vibration Detection Level Initialization (Fn01B)	7-26
7.17 Display of SERVOPACK and Servomotor ID (Fn01E)	7-28
7.18 Display of Servomotor ID in Feedback Option Module (Fn01F)	7-30
7.19 Origin Setting (Fn020)	7-32
7.20 Software Reset (Fn030)	7-33
7.21 EasyFFT (Fn206)	7-34
7.22 Online Vibration Monitor (Fn207)	7-37

7.1 List of Utility Functions

Utility functions are used to execute the functions related to servomotor operation and adjustment. Each utility function has a number starting with Fn.

The following table lists the utility functions and reference section.

Function No.	Function	Operation from the Panel Operator	Operation from the Digital Operator or SigmaWin+	Reference Section
Fn000	Alarm history display	○	○	7.2
Fn002	JOG operation	○	○	7.3
Fn003	Origin search	○	○	7.4
Fn004	Program JOG operation	○	○	7.5
Fn005	Initializing parameter settings	○	○	7.6
Fn006	Clearing alarm history	○	○	7.7
Fn008	Absolute encoder multiturn reset and encoder alarm reset	○	○	5.9.4
Fn009	Automatic tuning of analog (speed, torque) reference offset	○	○	5.3.2 5.5.2
Fn00A	Manual servo tuning of speed reference offset	○	○	5.3.2
Fn00B	Manual servo tuning of torque reference offset	○	○	5.5.2
Fn00C	Offset adjustment of analog monitor output	○	○	7.8
Fn00D	Gain adjustment of analog monitor output	○	○	7.9
Fn00E	Automatic offset-signal adjustment of the motor current detection signal	○	○	7.10
Fn00F	Manual offset-signal adjustment of the motor current detection signal	○	○	7.11
Fn010	Write prohibited setting	○	○	7.12
Fn011	Servomotor model display	○	○	7.13
Fn012	Software version display	○	○	7.14
Fn013	Multiturn limit value setting change when a multiturn limit disagreement alarm occurs	○	○	5.9.7
Fn014	Resetting configuration error in option modules	○	○	7.15
Fn01B	Vibration detection level initialization	○	○	7.16
Fn01E	Display of SERVOPACK and servomotor ID	×	○	7.17
Fn01F	Display of servomotor ID in feedback option module	×	○	7.18
Fn020	Origin setting	○	○	7.19
Fn030	Software reset	○	○	7.20
Fn200	Tuning-less levels setting	○	○	6.2.2
Fn201	Advanced autotuning	×	○	6.3.2
Fn202	Advanced autotuning by reference	×	○	6.4.2
Fn203	One-parameter tuning	○*	○	6.5.2
Fn204	Anti-resonance control adjustment function	×	○	6.6.2
Fn205	Vibration suppression function	×	○	6.7.2
Fn206	EasyFFT	○	○	7.21
Fn207	Online vibration monitor	○	○	7.22

○: Available ×: Not available

* There are functional limitations if the function is executed on the panel operator.

Note: Execute the utility function with either a panel operator, digital operator, or SigmaWin+. If they are used together, "no_oP" or "NO-OP" will be displayed when the utility function is executed.

7.2 Alarm History Display (Fn000)

This function displays the last ten alarms that have occurred in the SERVOPACK.
The latest ten alarm numbers and time stamps* can be checked.

* Time Stamps

A function that measures the ON times of the control power supply and main circuit power supply in 100-ms units and displays the total operating time when an alarm occurs. The time stamp operates around the clock for approximately 13 years.

<Example of Time Stamps>

If 36000 is displayed,

$3600000 \text{ [ms]} = 3600 \text{ [s]} = 60 \text{ [min]} = 1 \text{ [h]}$

Therefore, the total number of operating hours is 1 hour.

(1) Preparation

There are no tasks that must be performed before displaying the alarm history.

(2) Operating Procedure

Use the following procedure.

Step	Display after Operation	Keys	Operation
1			Press the MODE/SET Key to select the utility function. If a number other than Fn000 is displayed, press the UP Key or DOWN Key to select Fn000.
2			Press the DATA/SHIFT Key for approximately one second. The latest alarm data is displayed.
3	 Alarm Sequence Number The higher the number, the older the alarm data. Alarm Code See the alarm table.		Press the DOWN Key to display one older alarm data. (To display one newer alarm data, press the UP Key.) The higher the far-left digit, the older the alarm data.
4			Press the DATA/SHIFT Key. The lower four digits of Time Stamp are displayed.
5			Press the DATA/SHIFT Key. The middle four digits of Time Stamp are displayed.
6			Press the DATA/SHIFT Key. The higher two digits of Time Stamp are displayed.
7			Press the DATA/SHIFT Key. The alarm number is displayed again.
8			Press the DATA/SHIFT Key for approximately one second. "Fn000" is displayed again.

Note:

- If the same alarm occurs after more than one hour, the alarm will be saved. If it occurs in less than one hour, it will not be saved.
- The display "□.---" means no alarm occurs.
- Delete the alarm history using the parameter Fn006. The alarm history is not cleared on alarm reset or when the SERVOPACK main circuit power is turned OFF.

7.3 JOG Operation (Fn002)

JOG operation is used to check the operation of the servomotor under speed control without connecting the SERVOPACK to the host controller.

CAUTION

- While the SERVOPACK is in JOG operation, the overtravel function will be disabled. Consider the operating range of the machine when performing JOG operation for the SERVOPACK.

(1) Preparation

The following conditions must be met to perform a jog operation.

- The write prohibited setting parameter (Fn010) must be set to Write permitted (P.0000).
- The main circuit power supply must be ON.
- All alarms must be cleared.
- The hardwire baseblock (HWBB) must be disabled.
- The servo ON signal (/S-ON) must be OFF.
- The JOG speed must be set considering the operating range of the machine.
Set the jog speed in Pn304.

Pn304	Jog Speed				Classification
	Setting Range	Setting Unit	Factory Setting	When Enabled	
	0 to 10000	1 min ⁻¹ *	500	Immediately	

* When using an SGMCS direct drive motor, the setting unit will be automatically changed to 0.1 min⁻¹.

(2) Operating Procedure

Use the following procedure. The following example is given when the rotating direction of servomotor is set as Pn000.0=0 (Forward rotation by forward reference).

Step	Display after Operation	Keys	Operation
1			Press the MODE/SET Key to select the utility function.
2			Press the UP or DOWN Key to select Fn002.
3			Press the DATA/SHIFT Key for approximately one second. The display shown on the left appears.
4			Press the MODE/SET Key to turn the servomotor power ON.
5			The servomotor will rotate at the speed set in Pn304 while the UP Key (for forward rotation) or DOWN Key (for reverse rotation) is pressed.
6			Press the MODE/SET Key to turn the servomotor power OFF. Note: The servomotor power can be turned OFF by pressing the DATA/SHIFT Key for approximately one second.

(cont'd)

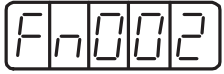
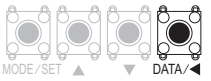
Step	Display after Operation	Keys	Operation
7			Press the DATA/SHIFT Key for approximately one second. "Fn002" is displayed again.
8	To enable the change in the setting, turn the power OFF and ON again.		

7.4 Origin Search (Fn003)

The origin search is designed to position the origin pulse position of the incremental encoder (phase C) and to clamp at the position.

CAUTION

- Perform origin searches without connecting the coupling.
The forward run prohibited (P-OT) and reverse run prohibited (N-OT) signals are not effective in origin search mode.

This function is used when the motor shaft needs to be aligned to the machine.

Motor speed at the time of execution: 60 min^{-1}

(For SGMCS direct drive motors, the speed at the time of execution is 6 min^{-1} .)

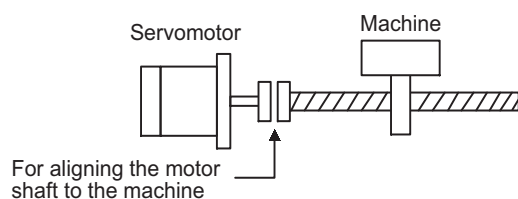

(1) Preparation

The following conditions must be met to perform the origin search.

- The write prohibited setting parameter (Fn010) must be set to Write permitted (P.0000).
- The main circuit power supply must be ON.
- All alarms must be cleared.
- The hardwire baseblock (HWBB) must be disabled.
- The servo ON signal (/S-ON) must be OFF.

(2) Operating Procedure

Use the following procedure.

Step	Display after Operation	Keys	Operation									
1			Press the MODE/SET Key to select the utility function.									
2			Press the UP or DOWN Key to select Fn003.									
3			Press the DATA/SHIFT Key for approximately one second, and the display shown on the left appears.									
4			Press the MODE/SET Key to turn the servomotor power ON. The display shown on the left appears.									
5			<p>Pressing the UP Key will rotate the servomotor in the forward direction. Pressing the DOWN Key will rotate the servomotor in the reverse direction. The rotation direction of the servomotor changes according to the setting of Pn000.0 as shown in the following table.</p> <table border="1"> <thead> <tr> <th>Parameter</th> <th>UP Key</th> <th>DOWN Key</th> </tr> </thead> <tbody> <tr> <td>n.□□□0</td> <td>CCW</td> <td>CW</td> </tr> <tr> <td>n.□□□1</td> <td>CW</td> <td>CCW</td> </tr> </tbody> </table> <p>Note: Direction when viewed from the load of the servomotor.</p>	Parameter	UP Key	DOWN Key	n.□□□0	CCW	CW	n.□□□1	CW	CCW
Parameter	UP Key	DOWN Key										
n.□□□0	CCW	CW										
n.□□□1	CW	CCW										
6	 Display flashes.		<p>When the servomotor origin search is completed, the display flashes.</p> <p>At this moment, the servomotor is servo-locked at the origin pulse position.</p>									
7			Press the DATA/SHIFT Key for approximately one second. "Fn003" is displayed again.									
8	To enable the change in the setting, turn the power OFF and ON again.											

7.5 Program JOG Operation (Fn004)

The program JOG operation is a utility function, that allows continuous operation determined by the preset operation pattern, movement distance, movement speed, acceleration/deceleration time, waiting time, and number of times of movement.

This function can be used to move the servomotor without it having to be connected to a host controller for the machine as a trial operation in JOG operation mode. Program JOG operation can be used to confirm the operation and for simple positioning operations.

(1) Preparation

The following conditions must be met to perform the program JOG operation.

- The write prohibited setting parameter (Fn010) must be set to Write permitted (P.0000).
- The main circuit power supply must be ON.
- All alarms must be cleared.
- The hardwire baseblock (HWBB) must be disabled.
- The servo ON signal (/S-ON) must be OFF.
- The travel distance and speed must be set correctly considering the machine operation range and safe operation speed.
- There must be no overtravel.

(2) Additional Information

- The program JOG operation is carried out in position control. However, the pulse reference input to the SERVOPACK cannot be used.
- The functions that are applicable for position control, such as position reference filter, can be used.
- The overtravel function is enabled in this function.
- When using an absolute encoder, the SEN signal needs not be input since it is always enabled.
- The reference pulse input multiplication switching function is disabled.

(3) Program JOG Operation Patterns

The following describes an example of program JOG operation pattern. The following example is given when the rotating direction of the servomotor is set as Pn000.0 = 0 (Forward rotation by forward reference).

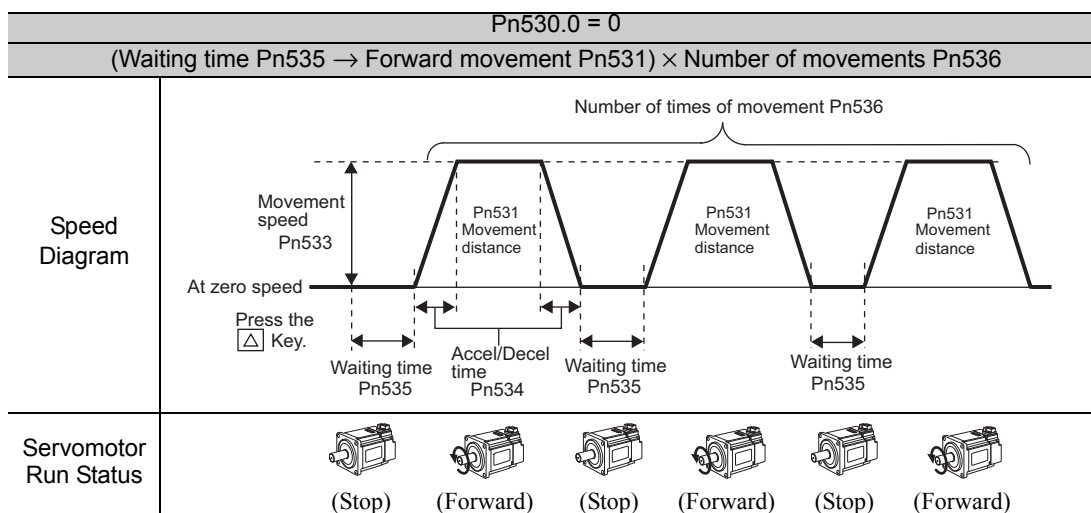

Note: When Pn536 (number of times of program JOG movement) is set to 0, infinite time operation is enabled. To stop infinite time operation, press the MODE/SET Key (or JOG/SVON Key of digital operator) to turn OFF the servomotor power.

Pn530.0 = 1
 (Waiting time Pn535 → Reverse movement Pn531) × Number of movements Pn536

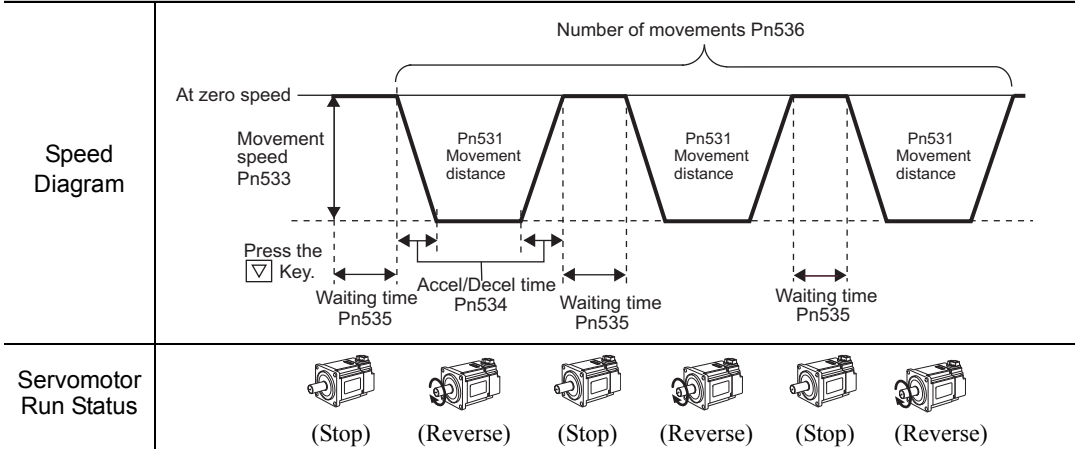

Note: When Pn536 (Number of Times of Program JOG Movement) is set to 0, infinite time operation is enabled. To stop infinite time operation, press the MODE/SET Key (or JOG/SVON Key of digital operator) to turn the servomotor power OFF.

Pn530.0 = 2
 (Waiting time Pn535 → Forward movement Pn531) × Number of movements Pn536
 (Waiting time Pn535 → Reverse movement Pn531) × Number of movements Pn536

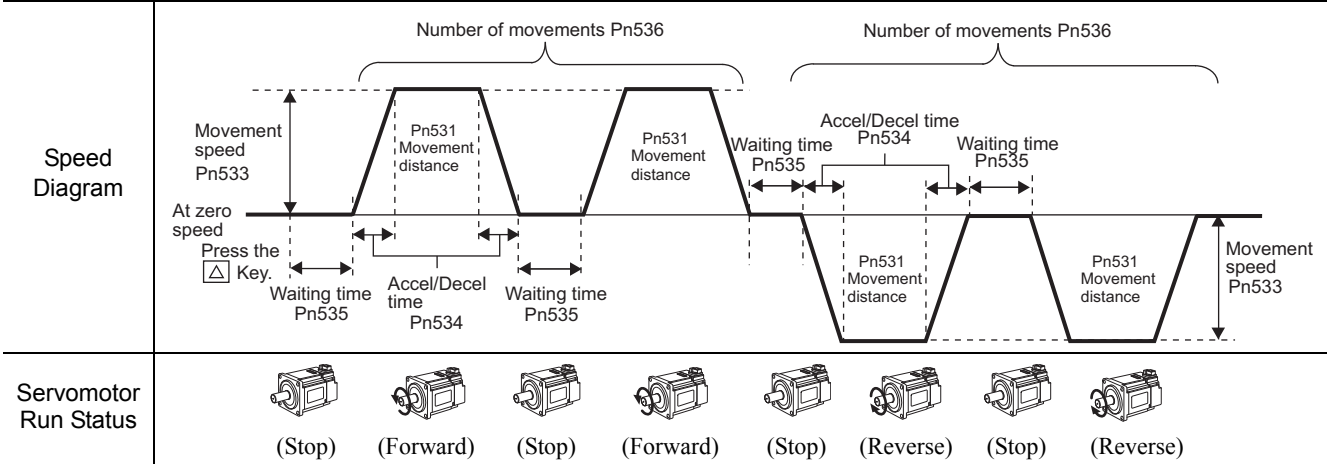

Note: When Pn530.0 is set to 2, infinite time operation is disabled.

Pn530.0 = 3
 (Waiting time Pn535 → Reverse movement Pn531) × Number of movements Pn536
 (Waiting time Pn535 → Forward movement Pn531) × Number of movements Pn536

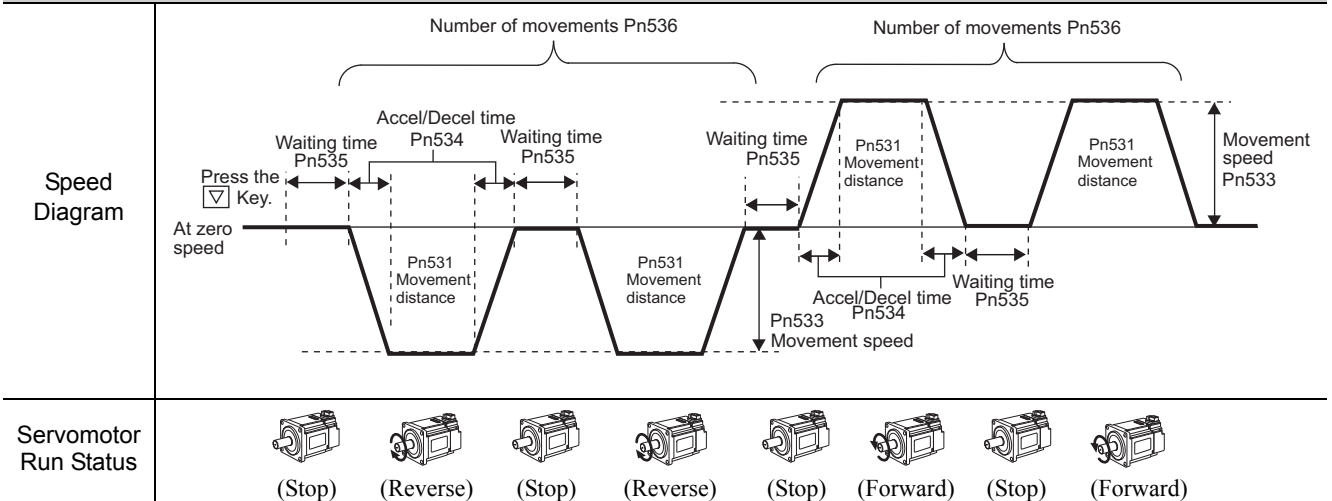

Note: When Pn530.0 is set to 3, infinite time operation is disabled.

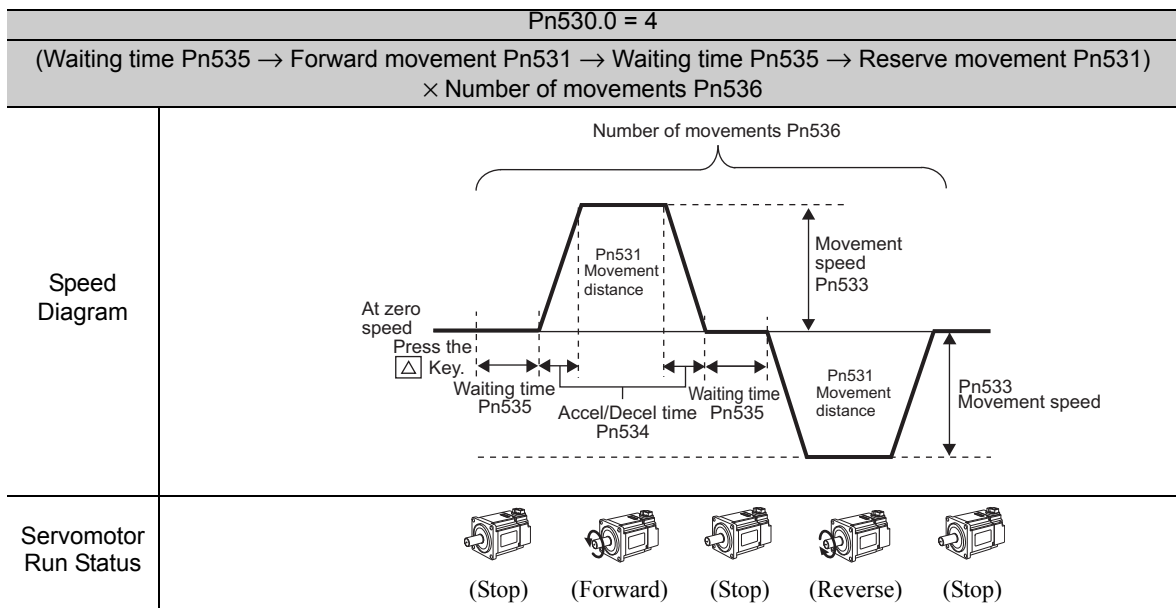

Note: When Pn536 (number of times of program JOG movement) is set to 0, infinite time operation is enabled. To stop infinite time operation, press the MODE/SET Key (or JOG/SVON Key of digital operator) to turn OFF the servomotor power.

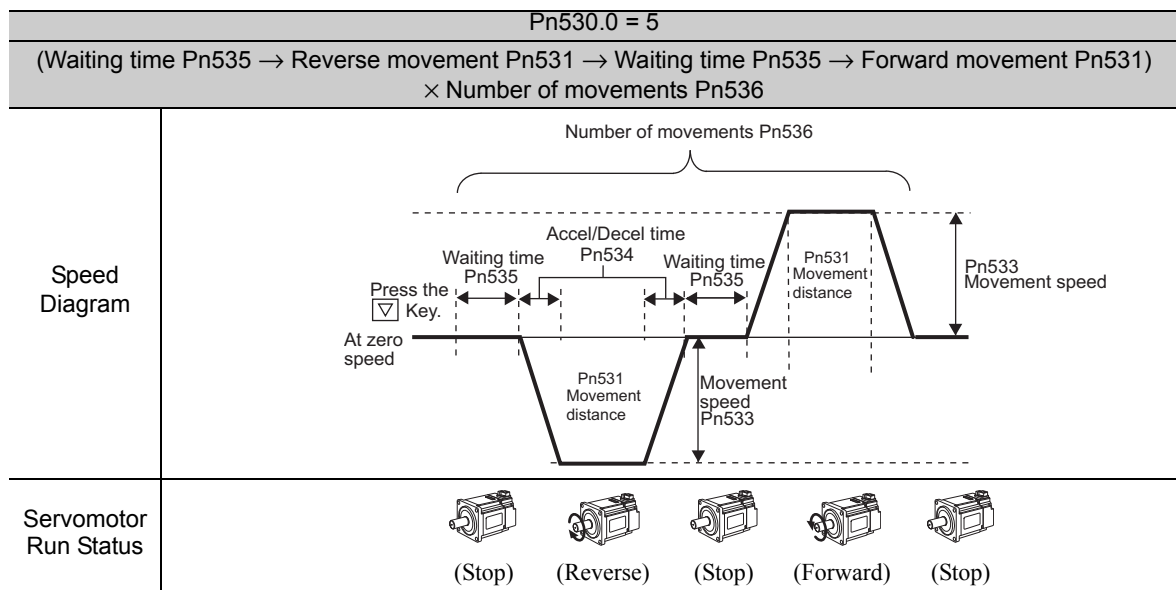

Note: When Pn536 (number of times of program JOG movement) is set to 0, infinite time operation is enabled. To stop infinite time operation, press the MODE/SET Key (or JOG/SVON Key of digital operator) to turn the servomotor power OFF.

(4) Related Parameters

The following parameters set the program JOG operation pattern. Do not change the settings while the program JOG operation is being executed.

Pn530	Program JOG Operation Related Switch Speed Position Torque				Classification
	Setting Range	Setting Unit	Factory Setting	When Enabled	
	0000 to 0005	—	0000	Immediately	Setup
Pn531	Program JOG Movement Distance Speed Position Torque				Classification
	Setting Range	Setting Unit	Factory Setting	When Enabled	
	1 to 1073741824	1 reference unit	32768	Immediately	Setup

(cont'd)

Pn533	Program JOG Movement Speed Speed Position Torque				Classification
	Setting Range	Setting Unit	Factory Setting	When Enabled	
	1 to 10000	1 min ⁻¹ *	500	Immediately	Setup
Pn534	Program JOG Acceleration/Deceleration Time Speed Position Torque				Classification
	Setting Range	Setting Unit	Factory Setting	When Enabled	
	2 to 10000	1 ms	100	Immediately	Setup
Pn535	Program JOG Waiting Time Speed Position Torque				Classification
	Setting Range	Setting Unit	Factory Setting	When Enabled	
	0 to 10000	1 ms	100	Immediately	Setup
Pn536	Number of Times of Program JOG Movement Speed Position Torque				Classification
	Setting Range	Setting Unit	Factory Setting	When Enabled	
	0 to 1000	1 time	1	Immediately	Setup

* When using an SGMCS direct drive motor, the setting unit will be automatically changed to 0.1 min⁻¹.

(5) Operating Procedure

Use the following procedure to perform the program JOG operation after setting a program JOG operation pattern.

Step	Display after Operation	Keys	Operation
1			Press the MODE/SET Key to select the utility function.
2			Press the UP or DOWN Key to select Fn004.
3			Press the DATA/SHIFT Key for approximately one second. The display shown on the left appears.
4			Press the MODE/SET Key to turn the servomotor power ON. The display shown on the left appears.
5			Press the UP or DOWN Key according to the first movement direction of the operation pattern. After the preset waiting time, the movement starts. Notes: • Press the MODE/SET Key during operation, and the servomotor power will turn OFF and the servomotor stops. • Press the DATA/SHIFT Key for approximately one second during operation, and the display of step 2 appears.
6			"End" flashes when the program JOG operation has been completed, and the screen returns to the display as shown on the left. Notes: • Press the MODE/SET Key, and the servomotor power will turn OFF and the display of step 3 appears. • Press the DATA/SHIFT Key for approximately one second, and the display of step 2 appears.
7	To enable the change in the setting, turn the power OFF and ON again.		

7.6 Initializing Parameter Settings (Fn005)

This function is used when returning to the factory settings after changing parameter settings.

 IMPORTANT	<ul style="list-style-type: none"> • Be sure to initialize the parameter settings while the servo ON (/S-ON) signal is OFF. • After initialization, turn OFF the power supply and then turn ON again to validate the settings.
---	--

Note: Any value adjusted with Fn009, Fn00A, Fn00B, Fn00C, Fn00D, Fn00E, and Fn00F cannot be initialized by Fn005.







(1) Preparation

The following conditions must be met to initialize the parameter values.

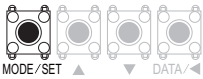
- The write prohibited setting parameter (Fn010) must be set to Write permitted (P.0000).
- The servo ON signal (/S-ON) must be OFF.

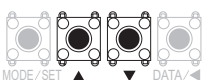
(2) Operating Procedure

Use the following procedure.

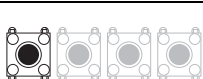
Step	Display after Operation	Keys	Operation
1			Press the MODE/SET Key to select the utility function.
2			Press the UP or DOWN Key to select Fn005.
3			Press the DATA/SHIFT Key for approximately one second. The display shown on the left appears.
4			Press the MODE/SET Key. Then, the parameters will be initialized. When the initialization has been completed, "donE" flashes on the display and returns to the screen as shown on the left.
5	To enable the change in the setting, turn the power OFF and ON again.		

7.7 Clearing Alarm History (Fn006)

The clear alarm history function deletes all of the alarm history recorded in the SERVOPACK.

Note: The alarm history is not deleted when the alarm reset is executed or the main circuit power supply of the SERVOPACK is turned OFF.









(1) Preparation

The follow conditions must be met to clear the alarm history.

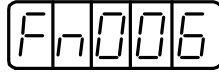
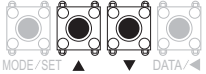
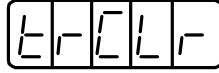
- The write prohibited setting parameter (Fn010) must be set to Write permitted (P.0000).

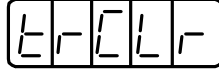
(2) Operating Procedure

Use the following procedure.

Step	Display after Operation	Keys	Operation
1			Press the MODE/SET Key to select the utility function.
2			Press the UP or DOWN Key to select Fn006.
3			Press the DATA/SHIFT Key for approximately one second. The display shown on the left appears.
4			Press the MODE/SET Key to clear the alarm history. When the data is cleared, "done" flashes on the display and returns to the screen as shown on the left.
5			Press the DATA/SHIFT Key for approximately one second. "Fn006" is displayed again.

7.8 Offset Adjustment of Analog Monitor Output (Fn00C)

This function is used to manually adjust the offsets for the analog monitor outputs (torque reference monitor output and motor speed monitor output). The offset values are factory-set before shipping. Therefore, the user need not usually use this function.

(1) Adjustment Example

An example of offset adjustment to the motor speed monitor is shown below.

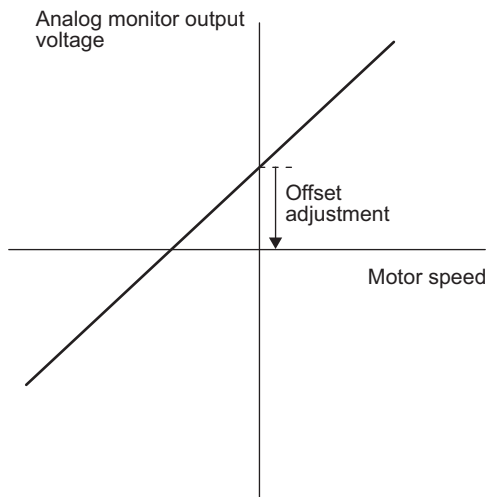

Item	Specifications
Offset Adjustment Range	-2.4 V to + 2.4 V
Adjustment Unit	18.9 mV/LSB

Note:

- The adjustment value will not be initialized when parameter settings are initialized using Fn005.
- Make offset adjustment with a measuring instrument connected, so that the analog monitor output is zero. An example of settings for a zero analog monitor output is shown below.
 - While the servomotor is not turned ON, set the monitor signal to the torque reference.
 - In speed control, set the monitor signal to the position error.

(2) Preparation

The following condition must be met to adjust the offsets of the analog monitor output.

- The write prohibited setting parameter (Fn010) must be set to Write permitted (P.0000).

(3) Operating Procedure

Use the following procedure to perform the offset adjustment of analog monitor output.

Step	Display after Operation	Keys	Operation
1			Press the MODE/SET Key to select the utility function.
2			Press the UP or DOWN Key to select Fn00C.
3			Press the DATA/SHIFT Key for approximately one second. The display shown on the left appears.

(cont'd)

Step	Display after Operation	Keys	Operation
4			Press the DATA/SHIFT Key. Offset data will be displayed as shown on the left.
5			Press the UP or DOWN Key to change the data.
6			Press the DATA/SHIFT Key to return to the screen as shown on the left.
7			Press the MODE/SET Key to switch to channel 2 (analog monitor 2) monitor output.
8			Press the DATA/SHIFT Key. Offset data will be displayed as shown on the left.
9			Press the UP or DOWN Key to change the data.
10			Press the DATA/SHIFT Key for approximately one second. "Ch2-o" is displayed, and then "Fn00C" is displayed again.

7.9 Gain Adjustment of Analog Monitor Output (Fn00D)

This function is used to manually adjust the gains for the analog monitor outputs (torque reference monitor output and motor rotating speed monitor output). The gain values are factory-set before shipping. Therefore, the user need not usually use this function.

(1) Adjustment Example

An example of gain adjustment to the motor rotating speed monitor is shown below.

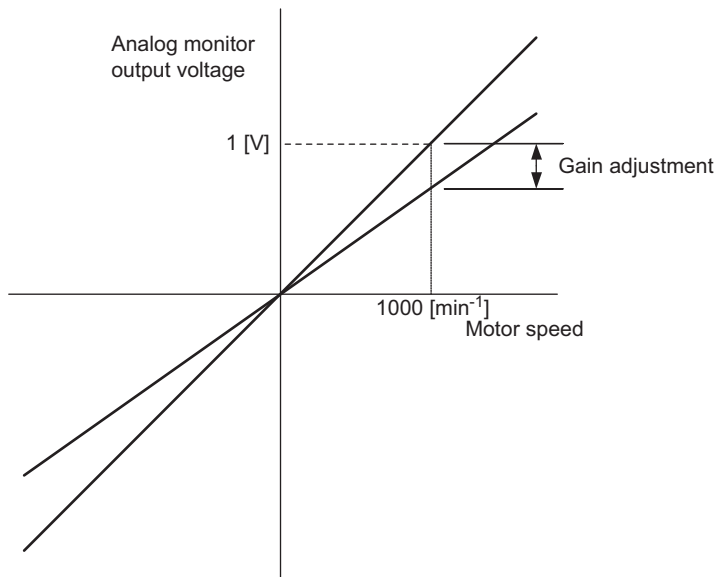

Item	Specifications
Gain-adjustment Range	100±50%
Adjustment Unit	0.4%/LSB

The gain adjustment range is made with a 100% output set as a center value (adjustment range: 50% to 150%). The following is a setting example.

<Setting the Set Value to -125>

$$100\% + (-125 \times 0.4) = 50\%$$

Therefore, the monitor output voltage is 0.5 time as high.

<Setting the Set Value to 125>

$$100\% + (125 \times 0.4) = 150\%$$

Therefore, the monitor output voltage is 1.5 times as high.

Note: The adjustment value will not be initialized when parameter settings are initialized using Fn005.

(2) Preparation

The following condition must be met to adjust the gain of the analog monitor output.

- The write prohibited setting parameter (Fn010) must be set to Write permitted (P.0000).

(3) Operating Procedure

Use the following procedure to perform the gain adjustment of analog monitor output.

Step	Display after Operation	Keys	Operation
1			Press the MODE/SET Key to select the utility function.
2			Press the UP or DOWN Key to select Fn00D.
3			Press the DATA/SHIFT Key for approximately one second. The screen shown on the left will be displayed.
4			Press the DATA/SHIFT Key. Gain adjustment data will be displayed as shown on the left.
5			Press the UP or DOWN Key to change the gain.
6			Press the DATA/SHIFT Key to return to the screen as shown on the left.
7			Press the MODE/SET Key to switch to channel 2 (analog monitor 2) monitor output.
8			Press the DATA/SHIFT Key. Gain adjustment data will be displayed as shown on the left.
9			Press the UP or DOWN Key to change the gain.
10			Press the DATA/SHIFT Key for approximately one second. "Ch2-G" is displayed, and then "Fn00D" is displayed again.

7.10 Automatic Offset-Signal Adjustment of the Motor Current Detection Signal (Fn00E)

Perform this adjustment only if highly accurate adjustment is required for reducing torque ripple caused by current offset. The user need not usually use this function.



IMPORTANT

- Be sure to perform this function while the servo ON signal (/S-ON) is OFF.
- Execute the automatic offset adjustment if the torque ripple is too big when compared with those of other SERVOPACKs.

Note: The adjusted value is not initialized by executing the Fn005 function (Initializing Parameter Settings).

(1) Preparation

The following conditions must be met to automatically adjust the offset of the motor current detection signal.

- The write prohibited setting parameter (Fn010) must be set to Write permitted (P.0000).
- The SERVOPACK must be in Servo Ready status (Refer to 5.10.4).
- The servo ON signal (/S-ON) must be OFF.

(2) Operating Procedure

Use the following procedure.

Step	Display after Operation	Keys	Operation
1			Press the MODE/SET Key to select the utility function.
2			Press the UP or DOWN Key to select Fn00E.
3			Press the DATA/SHIFT Key for approximately one second. The screen shown on the left will be displayed.
4			Press the MODE/SET Key to perform automatic offset adjustment. After the adjustment is completed, "donE" flashes on the display and the screen returns to the message shown on the left.
5			Press the DATA/SHIFT Key for approximately one second. "Fn00E" is displayed again.

7.11 Manual Offset-Signal Adjustment of the Motor Current Detection Signal (Fn00F)

Use this function only if the torque ripple is still high after the automatic offset-signal adjustment of the motor current detection signal (Fn00E).

 IMPORTANT	<p>If this function is adjusted incorrectly and then executed, characteristics of the servomotor performance could be affected.</p> <p>Observe the following precautions when performing manual servo tuning.</p> <ul style="list-style-type: none"> • Run the servomotor at a speed of approximately 100 min^{-1}. • Adjust the offset while monitoring the torque reference with the analog monitor until the ripple of torque reference monitor's waveform is minimized. • Adjust the phase-U and phase-V offset amounts alternately several times until these offsets are well balanced.
---	--

Note: The adjusted value is not initialized by executing the Fn005 function (Initializing Parameter Settings).











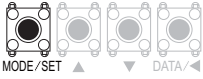

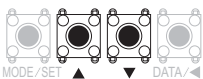
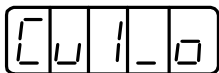

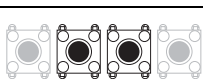
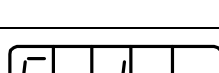

(1) Preparation

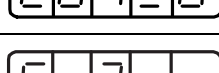
The following condition must be met to manually adjust the offset of the motor current detection signal.

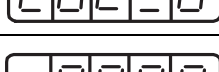
- The write prohibited setting parameter (Fn010) must be set to Write permitted (P.0000).

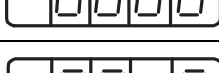
(2) Operating Procedure

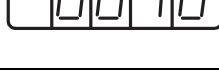
Use the following procedure.

Step	Display after Operation	Keys	Operation
1			Press the MODE/SET Key to select the utility function.
2			Press the UP or DOWN Key to select Fn00F.
3			Press the DATA/SHIFT Key for approximately one second to adjust the phase-U offset amount. The display shown on the left (phase U) appears.
4			Press the DATA/SHIFT Key to display the phase-U offset amount.
5			Press the UP or DOWN Key to adjust the offset amount. Carefully adjust the offset amount while monitoring the torque reference monitor signal. Adjustable range: -512 to +511
6			Press the DATA/SHIFT Key. The display shown on the left appears.
7			Press the MODE/SET Key to adjust the phase-V offset amount. The display shown on the left (phase V) appears.
8			Press the DATA/SHIFT Key to display the phase-V offset amount.
9			Press the UP or DOWN Key to adjust the offset amount. Carefully adjust the offset amount while monitoring the torque reference monitor signal. Adjustable range: -512 to +511
10			Press the DATA/SHIFT Key for approximately one second. "Cu2-o" is displayed, and then "Fn00F" is displayed again.

7.12 Write Prohibited Setting (Fn010)

This function prevents changing parameters by mistake and sets restrictions on the execution of the utility function.

Parameter changes and execution of the utility function become restricted in the following manner when Write prohibited (P.0001) is assigned to the write prohibited setting parameter (Fn010).

- Parameters: Cannot be changed. If you attempt to change it, "NO-OP" will flash on the display and the screen will return to the main menu.
- Utility Function: Some functions cannot be executed. (Refer to the following table.) If you attempt to execute these utility functions, "NO-OP" will flash on the display and the screen will return to the main menu.

Parameter No.	Function	Write Prohibited Setting	Reference Section
Fn000	Alarm history display	Executable	7.2
Fn002	JOG operation	Cannot be executed	7.3
Fn003	Origin search	Cannot be executed	7.4
Fn004	Program JOG operation	Cannot be executed	7.5
Fn005	Initializing parameter settings	Cannot be executed	7.6
Fn006	Clearing alarm history	Cannot be executed	7.7
Fn008	Absolute encoder multiturn reset and encoder alarm reset	Cannot be executed	5.9.4
Fn009	Automatic tuning of analog (speed, torque) reference offset	Cannot be executed	5.3.2 5.5.2
Fn00A	Manual servo tuning of speed reference offset	Cannot be executed	5.3.2
Fn00B	Manual servo tuning of torque reference offset	Cannot be executed	5.5.2
Fn00C	Offset adjustment of analog monitor output	Cannot be executed	7.8
Fn00D	Gain adjustment of analog monitor output	Cannot be executed	7.9
Fn00E	Automatic offset-signal adjustment of the motor current detection signal	Cannot be executed	7.10
Fn00F	Manual offset-signal adjustment of the motor current detection signal	Cannot be executed	7.11
Fn010	Write prohibited setting	–	7.12
Fn011	Servomotor model display	Executable	7.13
Fn012	Software version display	Executable	7.14
Fn013	Multiturn limit value setting change when a multiturn limit disagreement alarm occurs	Cannot be executed	5.9.7
Fn014	Resetting configuration error in option modules	Cannot be executed	7.15
Fn01B	Vibration detection level initialization	Cannot be executed	7.16
Fn01E	Display of SERVOPACK and servomotor ID	Executable	7.17
Fn01F	Display of servomotor ID in feedback option module	Executable	7.18
Fn020	Origin setting	Cannot be executed	7.19
Fn030	Software reset	Executable	7.20
Fn200	Tuning-less levels setting	Cannot be executed	6.2.2
Fn201	Advanced autotuning	Cannot be executed	6.3.2
Fn202	Advanced autotuning by reference	Cannot be executed	6.4.2
Fn203	One-parameter tuning	Cannot be executed	6.5.2
Fn204	Anti-resonance control adjustment function	Cannot be executed	6.6.2
Fn205	Vibration suppression function	Cannot be executed	6.7.2
Fn206	EasyFFT	Cannot be executed	7.21
Fn207	Online vibration monitor	Cannot be executed	7.22

(1) Preparation









There are no tasks that must be performed before the execution.

(2) Operating Procedure

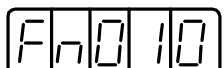
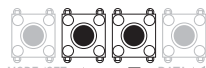
Follow the steps to set enable or disable writing.

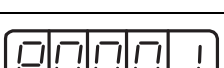
Setting values are as follows:

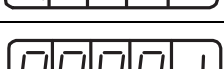
- "P.0000": Write permitted (Releases write prohibited mode.) [Factory setting]
- "P.0001": Write prohibited (Parameters become write prohibited from the next power ON.)

Step	Display after Operation	Keys	Operation
1			Press the MODE/SET Key to select the utility function.
2			Press the UP or DOWN Key to select Fn010.
3			Press the DATA/SHIFT Key for approximately one second. The display shown on the left appears.
4			Press the UP or DOWN Key to set a value: P.0000: Write permitted [Factory setting] P.0001: Write prohibited
5			Press the MODE/SET Key to register the value. When the setting has been completed, "donE" flashes on the display and the screen returns to the state shown on the left. Note: If any value other than P.0000 or P.0001 is set, "Error" will be displayed on the screen.
6	To enable the change in the setting, turn the power OFF and ON again.		

7.13 Servomotor Model Display (Fn011)

This function is used to check the servomotor model, voltage, capacity, encoder type, and encoder resolution. If the SERVOPACK has been custom-made, you can also check the specification codes of SERVOPACKS.

(1) Preparation

There are no tasks that must be performed before the execution.





(2) Operating Procedure

Use the following procedure.

Step	Display after Operation	Keys	Operation																														
1			Press the MODE/SET Key to select the utility function.																														
2			Press the UP or DOWN Key to select Fn011.																														
3			Press the DATA/SHIFT Key for approximately one second to display the servomotor voltage and model codes. <div style="display: flex; justify-content: space-around;"> <table border="1" style="margin-right: 20px;"> <caption>Servomotor Voltage</caption> <thead> <tr> <th>Code</th> <th>Type</th> </tr> </thead> <tbody> <tr> <td>01</td> <td>200 VAC</td> </tr> <tr> <td>02</td> <td>400 VAC</td> </tr> </tbody> </table> <table border="1"> <caption>Servomotor Model</caption> <thead> <tr> <th>Code</th> <th>Model</th> </tr> </thead> <tbody> <tr> <td>60</td> <td>SGMAV</td> </tr> <tr> <td>62</td> <td>SGMSV</td> </tr> <tr> <td>63</td> <td>SGMGV</td> </tr> <tr> <td>6D</td> <td>SGMJV</td> </tr> <tr> <td>21</td> <td>SGMPS</td> </tr> <tr> <td>32</td> <td>SGMCS-□□C</td> </tr> <tr> <td>33</td> <td>SGMCS-□□D</td> </tr> <tr> <td>34</td> <td>SGMCS-□□B</td> </tr> <tr> <td>35</td> <td>SGMCS-□□E</td> </tr> <tr> <td>36</td> <td>SGMCS-□□L</td> </tr> <tr> <td>37</td> <td>SGMCS-□□M</td> </tr> </tbody> </table> </div>	Code	Type	01	200 VAC	02	400 VAC	Code	Model	60	SGMAV	62	SGMSV	63	SGMGV	6D	SGMJV	21	SGMPS	32	SGMCS-□□C	33	SGMCS-□□D	34	SGMCS-□□B	35	SGMCS-□□E	36	SGMCS-□□L	37	SGMCS-□□M
Code	Type																																
01	200 VAC																																
02	400 VAC																																
Code	Model																																
60	SGMAV																																
62	SGMSV																																
63	SGMGV																																
6D	SGMJV																																
21	SGMPS																																
32	SGMCS-□□C																																
33	SGMCS-□□D																																
34	SGMCS-□□B																																
35	SGMCS-□□E																																
36	SGMCS-□□L																																
37	SGMCS-□□M																																
4			Press the MODE/SET Key to display the servomotor capacity. <div style="margin-left: 100px;"> Servomotor capacity in units of 10 W The above example indicates 100 W. </div>																														
5			Press the MODE/SET Key to display the encoder type and resolution codes. <div style="display: flex; justify-content: space-around;"> <table border="1" style="margin-right: 20px;"> <caption>Encoder Type</caption> <thead> <tr> <th>Code</th> <th>Type</th> </tr> </thead> <tbody> <tr> <td>00</td> <td>Incremental</td> </tr> <tr> <td>01</td> <td>Multiturn absolute value</td> </tr> <tr> <td>02</td> <td>Absolute value per rotation*</td> </tr> </tbody> </table> <table border="1"> <caption>Encoder Resolution</caption> <thead> <tr> <th>Code</th> <th>Resolution</th> </tr> </thead> <tbody> <tr> <td>13</td> <td>13-bit</td> </tr> <tr> <td>17</td> <td>17-bit</td> </tr> <tr> <td>20</td> <td>20-bit</td> </tr> </tbody> </table> </div>	Code	Type	00	Incremental	01	Multiturn absolute value	02	Absolute value per rotation*	Code	Resolution	13	13-bit	17	17-bit	20	20-bit														
Code	Type																																
00	Incremental																																
01	Multiturn absolute value																																
02	Absolute value per rotation*																																
Code	Resolution																																
13	13-bit																																
17	17-bit																																
20	20-bit																																

* The absolute encoder that shows values for a single rotation can only be used with a direct drive motor.

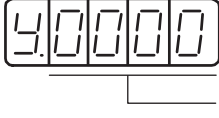
(cont'd)

Step	Display after Operation	Keys	Operation
6			<p>Press the MODE/SET Key to display the SERVOPACK's code for custom orders. The display "y.0000" means standard model. If anything other than "y.0000" is displayed, a customized device is being used.</p> 
7			<p>Press the DATA/SHIFT Key for approximately one second. "Fn011" is displayed again.</p>

7.14 Software Version Display (Fn012)

Select Fn012 to check the SERVOPACK and encoder software version numbers.

(1) Preparation

There are no tasks that must be performed before the execution.

(2) Operating Procedure

Use the following procedure.

Step	Display after Operation	Keys	Operation
1			Press the MODE/SET Key to select the utility function.
2			Press the UP or DOWN Key to select Fn012.
3			Press the DATA/SHIFT Key for approximately one second to display the SERVOPACK software version number.
4			Press the MODE/SET Key to display the encoder software version number. Note: If the MODE/SET Key is pressed again, a pre-programmed display will appear. The display will change as follows: 0.0000 → S.FFFF → F.FFFF.
5			Press the DATA/SHIFT Key for approximately one second. "Fn012" is displayed again.

7.15 Resetting Configuration Errors in Option Modules (Fn014)

The SERVOPACK with option module recognizes installation status and types of option modules that are connected to SERVOPACK. If an error is detected, the SERVOPACK issues an alarm. This function clears these alarms.

- Note 1. Alarms related to option module can be cleared only by this function. These alarms cannot be cleared by alarm reset or turning OFF the main circuit power supply.
2. Before clearing the alarm, perform corrective action for the alarm.

(1) Preparation

The following condition must be met to clear detection alarms of the option module.

- The write prohibited setting parameter (Fn010) must be set to Write permitted (P.0000).

(2) Operating Procedure

Use the following procedure.

Step	Display after Operation	Keys	Operation
1			Press the MODE/SET Key to select the utility function.
2			Press the UP or DOWN Key to select Fn014.
3			Press the DATA/SHIFT Key for approximately one second. The display shown on the left appears.
4			Press the UP or DOWN Key to select the option module to be cleared.
5			Press the MODE/SET Key for approximately one second. The display shown on the left appears.
6			Press the MODE/SET Key again. The alarms in option module will be cleared. The "done" flashes on the display and the screen returns to the message shown on the left.
7			Press the DATA/SHIFT Key for approximately one second. "Fn014" is displayed again.
8	To enable the change in the setting, turn the power OFF and ON again.		

7.16 Vibration Detection Level Initialization (Fn01B)

This function detects vibration when servomotor is connected to a machine in operation and automatically adjusts the vibration detection level (Pn312) to output more exactly the vibration alarm (A.520) and the vibration warning (A.911).

The vibration detection function detects vibration elements according to the motor speed.

Parameter		Meaning	When Enabled	Classification
Pn310	n.□□□0 [Factory setting]	Does not detect vibration.	Immediately	Setup
	n.□□□1	Outputs the warning (A.911) when vibration is detected.		
	n.□□□2	Outputs the alarm (A.520) when vibration is detected.		

If the vibration exceeds the detection level calculated by the following formula, the alarm or warning will be output according to the setting of vibration detection switch (Pn310).

$$\text{Detection level} = \frac{\text{Vibration detection level (Pn312 [min}^{-1}\text{])} \times \text{Vibration detection sensitivity (Pn311 [\%])}{100}$$

- Use this function if the vibration alarm (A.520) or the vibration warning (A.911) is not output correctly when a vibration at the factory setting of the vibration detection level (Pn312) is detected. In other cases, it is not necessary to use this function.
- The vibration alarm or warning detection sensibility differs depending on the machine conditions. In this case, fine-tune the setting of the vibration detection sensitivity (Pn311) using the above detection level formula as a guide.

Pn311	Vibration Detection Sensitivity				Classification
	<input type="checkbox"/> Speed <input type="checkbox"/> Position <input type="checkbox"/> Torque				
	Setting Range	Setting Unit	Factory Setting	When Enabled	
	50 to 500	1%	100	Immediately	Tuning



IMPORTANT

- The vibration may not be detected because of improper servo gains. Also, not all kinds of vibrations can be detected. Use the detection result as a guideline.
- Set a proper moment of inertia ratio (Pn103). Improper setting may result in the vibration alarm, warning misdetection, or non-detection.
- The references that are used to operate your system must be input to execute this function.
- Execute this function under the operating condition for which the vibration detection level should be set.
- Execute this function while the motor speed reaches at least 10% of its maximum.

(1) Preparation

The following conditions must be met to initialize the vibration detection level.

- The write prohibited setting parameter (Fn010) must be set to Write permitted (P.0000).
- The test without a motor function must be disabled (Pn00C.0 = 0).

(2) Operating Procedure

Use the following procedure.

Step	Display after Operation	Keys	Operation
1			Press the MODE/SET Key to select the utility function.
2			Press the UP or DOWN Key to select Fn01b.
3			Press the DATA/SHIFT Key for approximately one second. The display shown on the left appears.
4	 Display flashes.		Press the MODE/SET Key for approximately one second. The display shown on the left will flash and the vibration level will be detected and refreshed. Notes: • Operate the SERVOPACK with the references that will be used for actual operation. • If the servomotor is rotating at 10% or less of the maximum speed, "Error" will be displayed.
5			Press the MODE/SET Key again at a suitable time to complete vibration detection and refreshing the setting. This will enable the setting. If the setting has been completed normally, "done" will be displayed. If there was a setting failure, "Error" will be displayed.
6			Press the DATA/SHIFT Key for approximately one second. "Fn01b" is displayed again.

(3) Related Parameters

The following table lists parameters related to this function and their possibility of being changed while executing this function or of being changed automatically after executing this function.

- Parameters related to this function
These are parameters that are used or referenced when executing this function.
- Allowed changes during execution of this function
Yes : Parameters can be changed using SigmaWin+ while this function is being executed.
No : Parameters cannot be changed using SigmaWin+ while this function is being executed.
- Automatic changes after execution of this function
Yes : Parameter set values are automatically set or adjusted after execution of this function.
No : Parameter set values are not automatically set or adjusted after execution of this function.

Parameter	Name	Mid-execution changes	Automatic changes
Pn311	Vibration Detection Sensitivity	Yes	No
Pn312	Vibration Detection Level	No	Yes

7.17 Display of SERVOPACK and Servomotor ID (Fn01E)

This function displays ID information for SERVOPACK, servomotor, encoder, and option module connected to the SERVOPACK. The ID information of some option modules (SGDV-OFA01A) is not stored in the SERVOPACK. "Not available" will be displayed for these option modules.

This function cannot be executed from the panel operator on the SERVOPACK. To use this function, the digital operator (JUSP-OP05A-1-E) or SigmaWin+ is needed.

Refer to *Σ-V Series User's Manual, Operation of Digital Operator* (No.: SIEP S800000 55) for the operating procedure of the digital operator.

The following items can be displayed.

ID	Items to be Displayed
SERVOPACK ID	<ul style="list-style-type: none"> • SERVOPACK model • SERVOPACK serial number • SERVOPACK manufacturing date • SERVOPACK input voltage (V) • Maximum applicable motor capacity (W) • Maximum applicable motor rated current (Arms)
Servomotor ID	<ul style="list-style-type: none"> • Servomotor model • Servomotor order number • Servomotor manufacturing date • Servomotor input voltage (V) • Servomotor capacity (W) • Servomotor rated current (Arms)
Encoder ID	<ul style="list-style-type: none"> • Encoder model • Encoder serial number • Encoder manufacturing date • Encoder type/resolution
Safety Option Module ID*	<ul style="list-style-type: none"> • Safety Option Module model • Safety Option Module serial number • Safety Option Module manufacturing date • Safety Option Module ID number
Feedback Option Module ID*	<ul style="list-style-type: none"> • Feedback Option Module model • Feedback Option Module serial number (Reserved area) • Feedback Option Module manufacturing date • Feedback Option Module ID



























* If the option module is not connected, "Not connect" will be displayed after the module name.

(1) Preparation

There are no tasks that must be performed before the execution.

(2) Operating Procedure

Use the following procedure.

Step	Display after Operation	Keys	Operation
1	<pre> RUN - FUNCTION - Fn01B:Viblv Init Fn01E:SvMotOp ID Fn01F:FBOPMot ID Fn020:S-Orig Set </pre>	  	<p>Press the  Key to view the main menu for the utility function.</p> <p>Use the  or  Key to move through the list and select Fn01E.</p>
2	<pre> Serial number SERVOPACK model BB - SvMotOp ID - Driver SGDV-R70A01A ← D00241234590001 ← 07.04 200V, 50W ↑ ↑ ↑ Manufacturing Motor input Motor date voltage capacity </pre>	  	<p>Press the  Key.</p> <p>The display changes to the Fn01E execution display. The SERVOPACK ID information is displayed. Use the  or  Key to scroll left and right and to view other information.</p>
3	<pre> Serial number Servomotor model BB - SvMotOp ID - Motor SGMAV-A5A3A21 ← D00245789090001 ← 07.04 200V, 50W ↑ ↑ ↑ Manufacturing Motor input Motor date voltage capacity </pre>	  	<p>Press the  Key.</p> <p>The servomotor ID information is displayed. Use the  or  Key to scroll left and right and to view other information.</p>
4	<pre> Serial number Encoder model BB - SvMotOp ID - Encoder UTVIH-B20EA ← K247-0225E00200 ← 07.04 20bit-ABS ↑ ↑ ↑ Manufacturing Encoder Encoder date resolution type </pre>	  	<p>Press the  Key.</p> <p>The encoder ID information is displayed. Use the  or  Key to scroll left and right and to view other information.</p>
5	<pre> RUN - FUNCTION - Fn01B:Viblv Init Fn01E:SvMotOp ID Fn01F:FBOPMot ID Fn020:S-Orig Set </pre>		<p>Press the  Key.</p> <p>The display returns to the main menu of the utility function.</p>

7.18 Display of Servomotor ID in Feedback Option Module (Fn01F)

This function displays ID information for servomotor and encoder in Feedback Option Module connected to the SERVOPACK. If the option module is not connected, "Not connect" will be displayed after the module name.

This function cannot be executed from the panel operator on the SERVOPACK. To use this function, the digital operator (JUSP-OP05A-1-E) or SigmaWin+ is needed.

Refer to *Σ-V Series User's Manual, Operation of Digital Operator* (No.: SIEP S800000 55) for the operating procedure of the digital operator.

The following items can be displayed.





















ID	Items to be Displayed
Servomotor ID	<ul style="list-style-type: none"> • Servomotor model • Servomotor order number • Servomotor input voltage (V) • Servomotor capacity (W) • Servomotor rated current (Arms)
Encoder ID	<ul style="list-style-type: none"> • Encoder model • Encoder serial number • Encoder type/resolution (Two types of resolution display available: Number of bits and number of pulses/rev.)

(1) Preparation

There are no tasks that must be performed before the execution.

(2) Operating Procedure

Use the following procedure.

Step	Display after Operation	Keys	Operation
1	<pre> BB - FUNCTION - Fn01E:SvMotOp ID Fn01F:FBOPMot ID Fn020:S-Orig Set Fn030:Soft Reset </pre>	  	<p>Press the  Key to view the main menu for the utility function.</p> <p>Use the  or  Key to move through the list and select Fn01F.</p>
2*	<pre> Serial number Servomotor model BB - FBOPMotID - Motor SGM-04A312 R10419-511-DK5000 200V, 400W Input voltage Capacity </pre>	  	<p>Press the  Key.</p> <p>The display changes to the Fn01F execution display. The servomotor ID information is displayed. Use the  or  Key to scroll left and right and to view other information.</p>
3	<pre> Encoder type/resolution Encoder model BB - FBOPMotID - Encoder UTSTH-U13DB Serial No. 13bit-INC </pre>	  	<p>Press the  Key.</p> <p>The encoder ID information is displayed. Use the  or  Key to scroll left and right and to view other information.</p>
4	<pre> BB - FUNCTION - Fn01E:SvMotOp ID Fn01F:FBOPMot ID Fn020:S-Orig Set Fn030:Soft Reset </pre>		<p>Press the  Key.</p> <p>The display returns to the main menu of the utility function.</p>

* When fully-closed loop control is being used, step 2 is not included.

7.19 Origin Setting (Fn020)

When using an external absolute encoder for fully-closed loop control, this function is used to set the current position of the external absolute encoder as the origin (zero point position).

This function can be used with the following products.

Mitutoyo Corporation
ABS ST780A series
Model: ABS ST78□A/ST78□AL



IMPORTANT

- After execution of origin setting, the servo ready (/S-RDY) signal will become inactive because the system position data will have been changed. Always turn the power supply OFF and then ON again after execution of origin setting.

(1) Preparation

The following conditions must be met to set the origin.

- The write prohibited setting parameter (Fn010) must be set to Write permitted (P.0000).
- The servo ON signal (/S-ON) must be OFF.

(2) Operating Procedure

Use the following procedure.

Step	Display after Operation	Keys	Operation
1			Press the MODE/SET Key to select the utility function.
2			Press the UP or DOWN Key to select Fn020.
3			Press the DATA/SHIFT Key for approximately one second. The display shown on the left appears.
4			Press the UP Key until "OSEt5" is displayed. Note: If there is a mistake during key operations, "no_oP" will flash for approximately one second and then "Fn000" will be displayed again.
5			Press the MODE/SET Key to set the origin of the external encoder. After the setting is completed, "donE" flashes on the display and the screen returns to the message shown on the left.
6			Press the DATA/SHIFT Key for approximately one second. "Fn020" is displayed again.
7	To enable the change in the setting, turn the power OFF and ON again.		

7.20 Software Reset (Fn030)

This function enables resetting the SERVOPACK internally from software. This function is used when resetting alarms and changing the settings of parameters that normally require restarting the SERVOPACK. This function can be used to change those parameters without restarting the SERVOPACK.



IMPORTANT

- Start software reset operation after the servo ON signal (/S-ON) is OFF.
- This function resets the SERVOPACK independently of host controller. The SERVOPACK carries out the same processing as when the power supply is turned ON and outputs the ALM signal. The status of other output signals may be forcibly changed.

(1) Preparation

The following condition must be met to perform a software reset.

- The servo ON signal (/S-ON) must be OFF.

(2) Operating Procedure

Use the following procedure.

Step	Display after Operation	Keys	Operation
1			Press the MODE/SET Key to select the utility function.
2			Press the UP or DOWN Key to select Fn030.
3			Press the DATA/SHIFT Key for approximately one second. The display shown on the left appears.
4			Press the UP Key until "SrSt5" is displayed. Note: If there is a mistake during key operations, "no_oP" will flash for approximately one second.
5			Press the MODE/SET Key. The panel display will change to the same initial status display as when the power supply turns ON.

7.21 EasyFFT (Fn206)

EasyFFT sends a frequency waveform reference from the SERVOPACK to the servomotor and slightly rotates the servomotor several times over a certain period, thus causing machine vibration. The SERVOPACK detects the resonance frequency from the generated vibration and makes notch filter settings according to the resonance frequency detection. The notch filter is effective for the elimination of high-frequency vibration and noise.

Execute this function after the servo ON signal (/S-ON) is turned OFF if operation of the SERVOPACK results in high-frequency noise and vibration.

WARNING

- The servomotor rotates slightly when EasyFFT is executed. Do not touch the servomotor or machine during execution of EasyFFT, otherwise injury may result.

CAUTION

- Use the EasyFFT when the servo gain is low, such as in the initial stage of servo adjustment. If EasyFFT is executed after increasing the gain, the servo system may vibrate depending on the machine characteristics or gain balance.

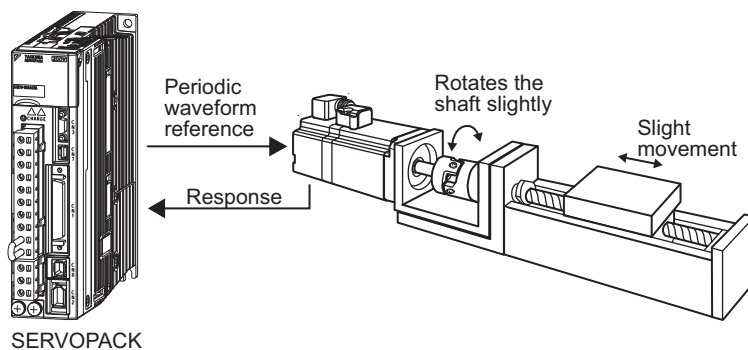

In addition to this function, online vibration monitor (Fn207) can be used to detect machine vibration and automatically make notch filter settings.

If a Σ -V Series SERVOPACK is used to make adjustments, it is recommended to use advanced autotuning. This built-in EasyFFT function is used to maintain interchangeability with previous models. There is normally no need to use it.

(1) Preparation

The following conditions must be met to perform EasyFFT.

- The write prohibited setting parameter (Fn010) must be set to Write permitted (P.0000).
- The main circuit power supply must be ON.
- All alarms must be cleared.
- The hardwire baseblock (HWBB) must be disabled.
- The servo ON signal (/S-ON) must be OFF.
- There must be no overtravel.
- The test without a motor function must be disabled (Pn00C.0 = 0).
- An external reference must not be input.

(2) Operating Procedure

Use the following procedure.

Step	Display after Operation	Keys	Operation
1			Press the MODE/SET Key to select the utility function.
2			Press the UP or DOWN Key to select Fn206.
3	 Setting reference amplitude		Press the DATA/SHIFT Key for approximately one second. The display shown on the left appears. The panel operator is in the reference amplitude setting mode.
4			Press the UP or DOWN Key to set a reference amplitude. Reference amplitude setting range: 1 to 800 Notes: <ul style="list-style-type: none"> At the initial execution of Fn206, do not change the reference amplitude setting, but start from the initial value 15. Though increasing reference amplitude increases the detection accuracy, the vibration and noise occurring on the machine will increase momentarily. Increase the amplitude value little by little, observing the result. The set value of reference amplitude is stored in Pn456.
5	 Run ready status		Press the DATA/SHIFT Key for approximately one second to enter the run ready status.
6			Press the MODE/SET Key to enter Servo ON status (the servomotor power ON). Note: Press the MODE/SET Key again to turn the servomotor power OFF. "F" is displayed to indicate the run ready status (step 5).
7	 Display flashes. Servomotor slight movement		In the Servo ON status (the servomotor power ON), press the UP Key (forward) or the DOWN Key (reverse). The servomotor oscillates (within 1/4 rotation) in automatic operation. The servomotor performs such movements for approximately 2 seconds. During this operation, the display shown on the left flashes. Notes: <ul style="list-style-type: none"> Press the MODE/SET Key to stop the servomotor. No detection is executed. "F" is displayed to indicate the run ready status (step 5). Do not enter the machine's working area, because the servomotor rotates. Some noise may result.
8	 Detection result example		At normal completion of the detection, "E_FFt" stops flashing and the detected resonance frequency is displayed. When failing to detect, "F----" is displayed. To set the detection result, proceed to step 9. To monitor the resonance frequency without setting the detection result, press the DATA/SHIFT Key for approximately one second to return to step 2. <IMPORTANT> If the operation ended normally but it took two seconds or more, the detection accuracy may not be good. Set the reference amplitude little higher than 15 in step 4 and re-execute the operation. A higher detection accuracy may be obtained. Though increasing reference amplitude increases the detection accuracy, the vibration and noise occurring on the machine will increase momentarily. Increase the amplitude value little by little, observing the result.

(cont'd)

Step	Display after Operation	Keys	Operation
9			<p>After the detection completes normally, press the MODE/SET Key. The optimum notch filter for the detected resonance frequency will automatically be set. When the notch filter is set correctly, the "donE" flashes and then the display shown on the left appears.</p> <p>When the 1st notch filter frequency is already set (Pn408.0=1), the 2nd notch filter frequency will be automatically set (Pn40C).</p> <p>Press the MODE/SET Key to return to step 5.</p> <p>Notes:</p> <ul style="list-style-type: none"> • If both the 1st and 2nd notch filter frequencies are already set (Pn408 = n.□1□1), no more notch filter frequencies can be set. • Set Pn408.0 to 0 (disables notch filter) not to use the notch filter frequency detected by executing the EasyFFT function.
10			Press the DATA/SHIFT Key for approximately one second. "Fn206" is displayed again.
11	To enable the change in the setting, turn the power OFF and ON again.		

(3) Related Parameters

The following table lists parameters related to this function and their possibility of being changed while executing this function or of being changed automatically after executing this function.

- Parameters related to this function
These are parameters that are used or referenced when executing this function.
- Allowed changes during execution of this function
Yes : Parameters can be changed using SigmaWin+ while this function is being executed.
No : Parameters cannot be changed using SigmaWin+ while this function is being executed.
- Automatic changes after execution of this function
Yes : Parameter set values are automatically set or adjusted after execution of this function.
No : Parameter set values are not automatically set or adjusted after execution of this function.

Parameter	Name	Mid-execution changes	Automatic changes
Pn408	Torque Related Function Switch	Yes	Yes
Pn409	1st Notch Filter Frequency	No	Yes
Pn40A	1st Notch Filter Q Value	No	No
Pn40C	2nd Notch Filter Frequency	No	Yes
Pn40D	2nd Notch Filter Q Value	No	No
Pn456	Sweep Torque Reference Amplitude	No	No

7.22 Online Vibration Monitor (Fn207)

If vibration is generated during operation and this function is executed while the servo ON signal (/S-ON) is still ON, the machine vibration can sometimes be suppressed by setting a notch filter or torque reference filter for the vibration frequencies.

When online, vibration frequency caused by machine resonance will be detected and the frequency that has the highest peak will be displayed on the panel operator. The effective torque reference filter or notch filter frequency for the vibration frequencies will be automatically selected and the related parameters will be automatically set.

In addition to this function, EasyFFT (Fn206) can be used to detect machine vibration and automatically make notch filter settings. Use the following flowchart to determine how these functions should be used.

If a Σ -V Series SERVOPACK is used to make adjustments, it is recommended that you use advanced autotuning. This built-in function is used to maintain interchangeability with previous models. There is normally no need to use it.

How to use EasyFFT (Fn206) and online vibration monitor (Fn207), when they are mainly used for servo gain adjustment.

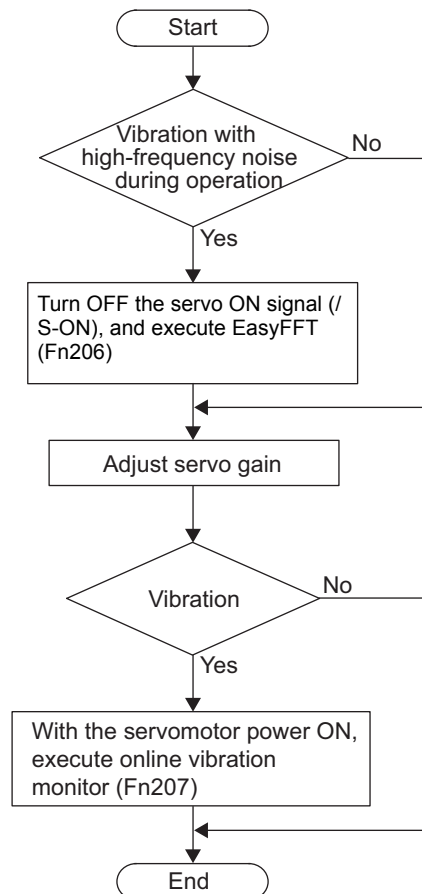

(1) Preparation

The following conditions must be met to perform online vibration monitoring.

- The write prohibited setting parameter (Fn010) must be set to Write permitted (P.0000).
- The servo ON signal (/S-ON) must be ON.
- There must be no overtravel.
- The correct moment of inertia (Pn103) must be set.
- The test without a motor function must be disabled (Pn00C.0 = 0).

(2) Operating Procedure

Use the following procedure.

Step	Display after Operation	Keys	Operation
1			Press the MODE/SET Key to select the utility function.
2			Press the UP or DOWN Key to select the Fn207.
3			Press the DATA/SHIFT Key for approximately one second. The display shown on the left appears.
4	 Display flashes.		Press the MODE/SET Key. "F" will flash, and the detection of frequencies will start automatically.
5	 Detection result example		When "F" stops flashing, detection has been completed. If detection has been performed normally, the results of detection will be displayed. The displayed value is the frequency of the highest peak of vibration. To set the detection result, proceed to step 6. To monitor the vibration frequency without setting the detection result, press the DATA/SHIFT Key for approximately one second to return to step 2. Notes: <ul style="list-style-type: none"> • If a frequency is not detected, "F----" will be displayed. • If detection processing is not completed normally for some reason, "no_oP" will be displayed.
6			If the MODE/SET Key is pressed, the optimum notch filter frequency or torque reference filter time constant for the frequency value will be set automatically, and "done" will flash if the setting is completed normally.
7			Press the DATA/SHIFT Key for approximately one second. "Fn207" is displayed again.

(3) Related Parameters

The following table lists parameters related to this function and their possibility of being changed while executing this function or of being changed automatically after executing this function.

- Parameters related to this function

These are parameters that are used or referenced when executing this function.

- Allowed changes during execution of this function

Yes : Parameters can be changed using SigmaWin+ while this function is being executed.

No : Parameters cannot be changed using SigmaWin+ while this function is being executed.

- Automatic changes after execution of this function

Yes : Parameter set values are automatically set or adjusted after execution of this function.

No : Parameter set values are not automatically set or adjusted after execution of this function.

Parameter	Name	Mid-execution changes	Automatic changes
Pn401	Torque Reference Filter Time Constant	No	Yes
Pn408	Torque Related Function Switch	Yes	Yes
Pn409	1st Notch Filter Frequency	No	Yes
Pn40A	1st Notch Filter Q Value	No	No
Pn40C	2nd Notch Filter Frequency	No	No
Pn40D	2nd Notch Filter Q Value	No	No

Monitor Displays (Un□□□)

8.1 List of Monitor Displays	8-2
8.2 Viewing Monitor Displays	8-3
8.3 Reading 32-bit Data in Decimal Displays	8-4
8.4 Monitoring Input Signals	8-5
8.4.1 Displaying Input Signal Status	8-5
8.4.2 Interpreting Input Signal Display Status	8-5
8.4.3 Input Signal Display Example	8-6
8.5 Monitoring Output Signals	8-7
8.5.1 Displaying Output Signal Status	8-7
8.5.2 Interpreting Output Signal Display Status	8-8
8.5.3 Output Signal Display Example	8-8
8.6 Monitoring Safety Input Signals	8-9
8.6.1 Displaying Safety Input Signals	8-9
8.6.2 Interpreting Safety Input Signal Display Status	8-9
8.6.3 Safety Input Signal Display Example	8-10
8.7 Monitor Display at Power ON	8-10

8.1 List of Monitor Displays

The monitor displays can be used for monitoring the I/O signal status, and SERVOPACK internal status.

Refer to the following table.

Parameter No.	Description	Unit
Un000	Motor rotating speed	min ⁻¹
Un001	Speed reference	min ⁻¹
Un002	Internal torque reference (in percentage to the rated torque)	%
Un003 ^{*3}	Rotational angle 1 (encoder pulses from the phase-C origin: decimal display)	encoder pulse ^{*4}
Un004	Rotational angle 2 (from polarity origin (electric angle))	deg
Un005 ^{*1}	Input signal monitor	–
Un006 ^{*2}	Output signal monitor	–
Un007 ^{*6}	Input reference pulse speed (valid only in position control)	min ⁻¹
Un008 ^{*6}	Position error amount (valid only in position control)	reference unit
Un009	Accumulated load ratio (in percentage to the rated torque: effective torque in cycle of 10 seconds)	%
Un00A	Regenerative load ratio (as a percentage of the processable regenerative power: regenerative power consumption in cycle of 10 seconds)	%
Un00B	Power consumed by DB resistance (in percentage to the processable power at DB activation: displayed in cycle of 10 seconds)	%
Un00C ^{*3, *6}	Input reference pulse counter	reference unit
Un00D ^{*3}	Feedback pulse counter	encoder pulse ^{*4}
Un00E ^{*3}	Fully-closed feedback pulse counter	external encoder resolution ^{*5}
Un012	Total operation time	100 ms
Un013 ^{*3}	Feedback pulse counter	reference unit
Un014	Effective gain monitor (gain settings 1 = 1, gain settings 2 = 2)	–
Un015	Safety I/O signal monitor	–
Un020	Motor rated speed	min ⁻¹
Un021	Motor maximum speed	min ⁻¹
Un022 ^{*7}	Installation environment monitor (Operation conditions in various environments can be monitored.)	%

*1. For details, refer to 8.4 Monitoring Input Signals.

*2. For details, refer to 8.5 Monitoring Output Signals.

*3. For details, refer to 8.3 Reading 32-bit Data in Decimal Displays.

*4. For details, refer to 5.4.4 Electronic Gear.







*5. For details, refer to 9.3.3 Setting Encoder Output Pulses (PAO, PBO, and PCO).

*6. If the reference pulse input multiplication switching function is enabled, the reference pulse will be multiplied by n to obtain the reference. This function is supported by software version 001A or later.

*7. The monitor Un022 can be used only with SGD V-□□□□□□B SERVOPACKs. For details, refer to 2 Installation of Σ -V Series USER'S MANUAL, Setup, Rotational Motor (No.: SIEP S800000 43).

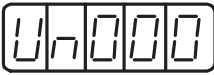
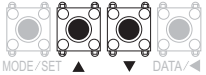
8.2 Viewing Monitor Displays

The example below shows how to view the contents of monitor number Un000 (when the servomotor rotates at 1500 min^{-1}).

Step	Display after Operation	Keys	Operation
1			Press the MODE/SET Key to select the monitor display.
2			If Un000 is not displayed, press the UP or DOWN Key to select Un000.
3			Press the DATA/SHIFT Key for approximately one second to display the motor rotating speed (Un000).
4			Press the DATA/SHIFT Key for approximately one second to return to the display of step 1.

8.3 Reading 32-bit Data in Decimal Displays

The 32-bit data is displayed in decimal format. This section describes how to read the display.

Step	Display after Operation	Keys	Operation
1			Press the MODE/SET Key to select the monitor display.
2			Press the UP or DOWN Key to display the parameter to be displayed in 32-bit decimal. In this example, "Un00D" is selected.
3	Lower 4 digits 		Press the DATA/SHIFT Key for approximately one second. The lower 4 digits of the setting of the selected parameter are displayed.
4	Middle 4 digits 		After checking the displayed digits, press the DATA/SHIFT Key. The middle 4 digits of the setting of the selected parameter are displayed.
5	Upper 2 digits 		Press the DATA/SHIFT Key again. The upper 2 digits of the setting of the selected parameter are displayed. Note: If the DATA/SHIFT Key is pressed after the upper 2 digits are displayed, the lower 4 digits of the setting will be displayed again.
6			Press the DATA/SHIFT Key for approximately one second to return to the display of step 2.

The method for reading the display is summarized below.

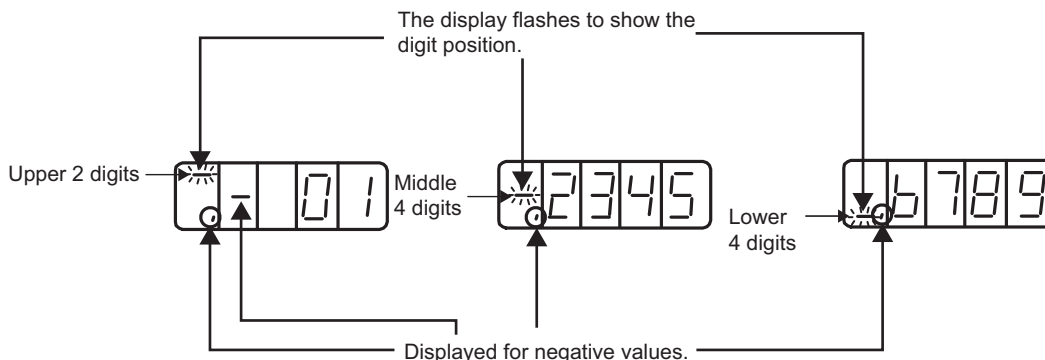

The number of pulses between -2147483648 and 2147483647 is displayed continuously. When the number of pulses is outside this range, the display will change as follows:

- The displayed value will change to 2147483647 when the number of pulses decreases by one from -2147483648. Thereafter, the displayed value will decrease according to the number of pulses.
- The displayed value will change to -2147483648 when the number of pulses increases by one from 2147483647. Thereafter, the displayed value will increase according to the number of pulses.

8.4 Monitoring Input Signals

The status of input signals can be checked with the input signal monitor (Un005). The procedure for displaying the status, the method of interpreting the display, and a display example are shown below.

8.4.1 Displaying Input Signal Status

Use the following steps to display the input signal status.

Step	Display after Operation	Keys	Operation
1			Press the MODE/SET Key to select the monitor display.
2			Press the UP or DOWN Key to select Un005.
3	 Input signal display status		The present status can be displayed on the 7-segment display on the panel operator by pressing the DATA/SHIFT Key for approximately one second. Refer to 8.4.2 Interpreting Input Signal Display Status.
4			Press the DATA/SHIFT Key for approximately one second to return to the display of step 2.

8.4.2 Interpreting Input Signal Display Status

The status of allocated signals is displayed on the 7-segment display on the panel operator.

Input terminals correspond to LED numbers as shown in the following table.

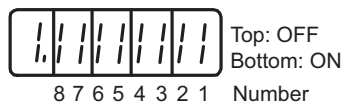

- When the input signal is in OFF status, the top segment (LED) is lit.
- When the input signal is in ON status, the bottom segment (LED) is lit.

Display LED Number	Input Terminal Name	Signal Name (Factory Setting)
1	CN1-40	/S-ON
2	CN1-41	/P-CON
3	CN1-42	P-OT
4	CN1-43	N-OT
5	CN1-44	/ALM-RST
6	CN1-45	/P-CL
7	CN1-46	/N-CL
8	CN1-4	SEN

Note: Input signals use the following circuit configuration.

- OFF: Open
- ON: Short-circuited

Example

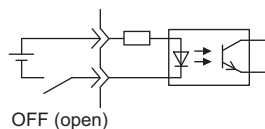

8.4.3 Input Signal Display Example

Input signals are displayed as shown below.

- When the /S-ON signal is ON

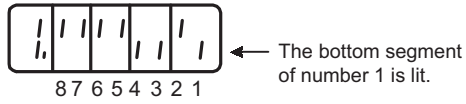

- When the /S-ON signal is OFF

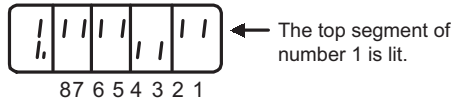

- When the P-OT signal operates

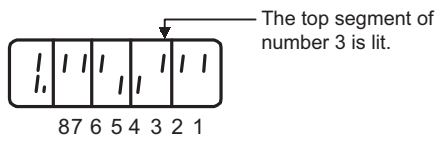







8.5 Monitoring Output Signals

The status of output signals can be checked with the output signal monitor (Un006). The procedure for displaying the status, the method of interpreting the display, and a display example are shown below.

8.5.1 Displaying Output Signal Status

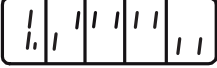
Use the following steps to display the output signal status.

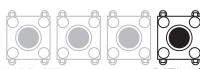
Step	Display after Operation	Keys	Operation
1			Press the MODE/SET Key to select the monitor display.
2			Press the UP or DOWN Key to select Un006.
3	 Output signal display status		The present status can be displayed on the 7-segment display on the panel operator by pressing the DATA/SHIFT Key for approximately one second. Refer to 8.5.2 <i>Interpreting Output Signal Display Status</i> .
4			Press the DATA/SHIFT Key for approximately one second to return to the display of step 2.

8.5.2 Interpreting Output Signal Display Status

The status of allocated signals is displayed on the 7-segment display on the panel operator.

Output terminals correspond to LED numbers as shown in the following table.

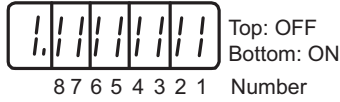

- When the output signal is in OFF status, the top segment (LED) is lit.
- When the output signal is in ON status, the bottom segment (LED) is lit.

Display LED Number	Output Terminal Name	Signal Name (Factory Setting)
1	CN1-31, -32	ALM
2	CN1-25, -26	/COIN or /V-CMP
3	CN1-27, -28	/TGON
4	CN1-29, -30	/S-RDY
5	CN1-37	ALO1
6	CN1-38	ALO2
7	CN1-39	ALO3
8	—	Reserved

Note: Input signals use the following circuit configuration.

- OFF: Transistor OFF
- ON: Transistor ON

Example

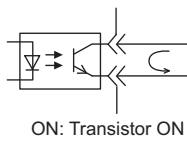

8.5.3 Output Signal Display Example

Output signals are displayed as shown below.

- When the ALM signal is OFF

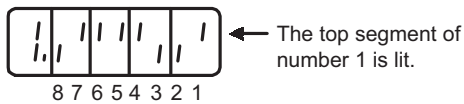

8.6 Monitoring Safety Input Signals

The status of safety input signals can be checked with the safety I/O signal monitor (Un015). The procedure for displaying the status, the method of interpreting the display, and a display example are shown below.

8.6.1 Displaying Safety Input Signals

Use the following procedure to display the input signal.

Step	Display after Operation	Keys	Operation
1			Press the MODE/SET Key to select the monitor display.
2			Press the UP or DOWN Key to select Un015.
3	 Input signal display status		The present status can be displayed on the 7-segment display on the panel operator by pressing the DATA/SHIFT Key for approximately one second. Refer to 8.6.2 <i>Interpreting Safety Input Signal Display Status</i> for how to read the display.
4			Press the DATA/SHIFT Key for approximately one second to return to the display of step 2.

8.6.2 Interpreting Safety Input Signal Display Status

The status of allocated signals is displayed on the 7-segment display on the panel operator.

Input terminals correspond to LED numbers as shown in the following table.



- When the safety input signal is in ON status, the top segment (LED) is lit.
- When the safety input signal is in OFF status, the bottom segment (LED) is lit.

Display LED Number	Input Terminal Name	Signal Name
1	CN8-3, -4	/HWBB1
2	CN8-5, -6	/HWBB2
3	—	Reserved
4	—	Reserved
5	—	Reserved
6	—	Reserved
7	—	Reserved
8	—	Reserved

Note: Input signals use the following circuit configuration.

- OFF: Open
- ON: Short-circuited

Example

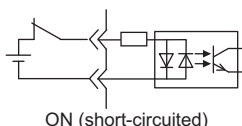

8.6.3 Safety Input Signal Display Example

Safety input signals are displayed as shown below.

- When the /HWBB1 signal turns OFF to activate the HWBB function

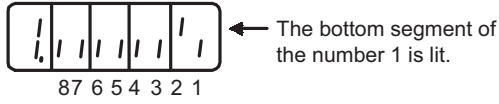

8.7 Monitor Display at Power ON

When Un number is set using Pn52F, the data of Un□□□ that was specified in the panel operator is displayed when the power is turned ON.

When the 0FFF is set (factory setting), the SERVOPACK becomes the status display mode (bb, run) at power ON.

Pn52F	Monitor Display at Power ON				Classification	
			Speed	Position		Torque
	Setting Range	Setting Unit	Factory Setting	When Enabled		
	0000 to 0FFF	-	0FFF	Immediately	Setup	

Fully-closed Loop Control

9.1 System Configuration and Connection Example for SERVOPACK with Fully-closed Loop Control	9-2
9.1.1 System Configuration	9-2
9.1.2 Internal Block Diagram of Fully-closed Loop Control	9-3
9.1.3 Serial Converter Unit	9-3
9.1.4 Example of Connections to External Encoders	9-5
9.1.5 Encoder Output Pulse Signals from SERVOPACK with an External Encoder by Renishaw plc	9-6
9.1.6 Precautions When Using an External Incremental Encoder by Magnescale	9-7
9.2 SERVOPACK Startup Procedure	9-10
9.3 Parameter Settings for Fully-closed Loop Control	9-12
9.3.1 Motor Rotation Direction	9-13
9.3.2 Sine Wave Pitch (Frequency) for an External Encoder	9-15
9.3.3 Setting Encoder Output Pulses (PAO, PBO, and PCO)	9-15
9.3.4 External Absolute Encoder Data Reception Sequence	9-16
9.3.5 Electronic Gear	9-19
9.3.6 Alarm Detection	9-20
9.3.7 Analog Monitor Signal	9-21
9.3.8 Speed Feedback Method during Fully-closed Loop Control	9-21

9.1 System Configuration and Connection Example for SERVOPACK with Fully-closed Loop Control

This section describes the system configuration and connection example for the SERVOPACK with fully-closed loop control.

9.1.1 System Configuration

The following figure shows an example of the system configuration.

SERVOPACK with Fully-closed Module
Model: SGD□□□□□□□□□□□□□□□□001

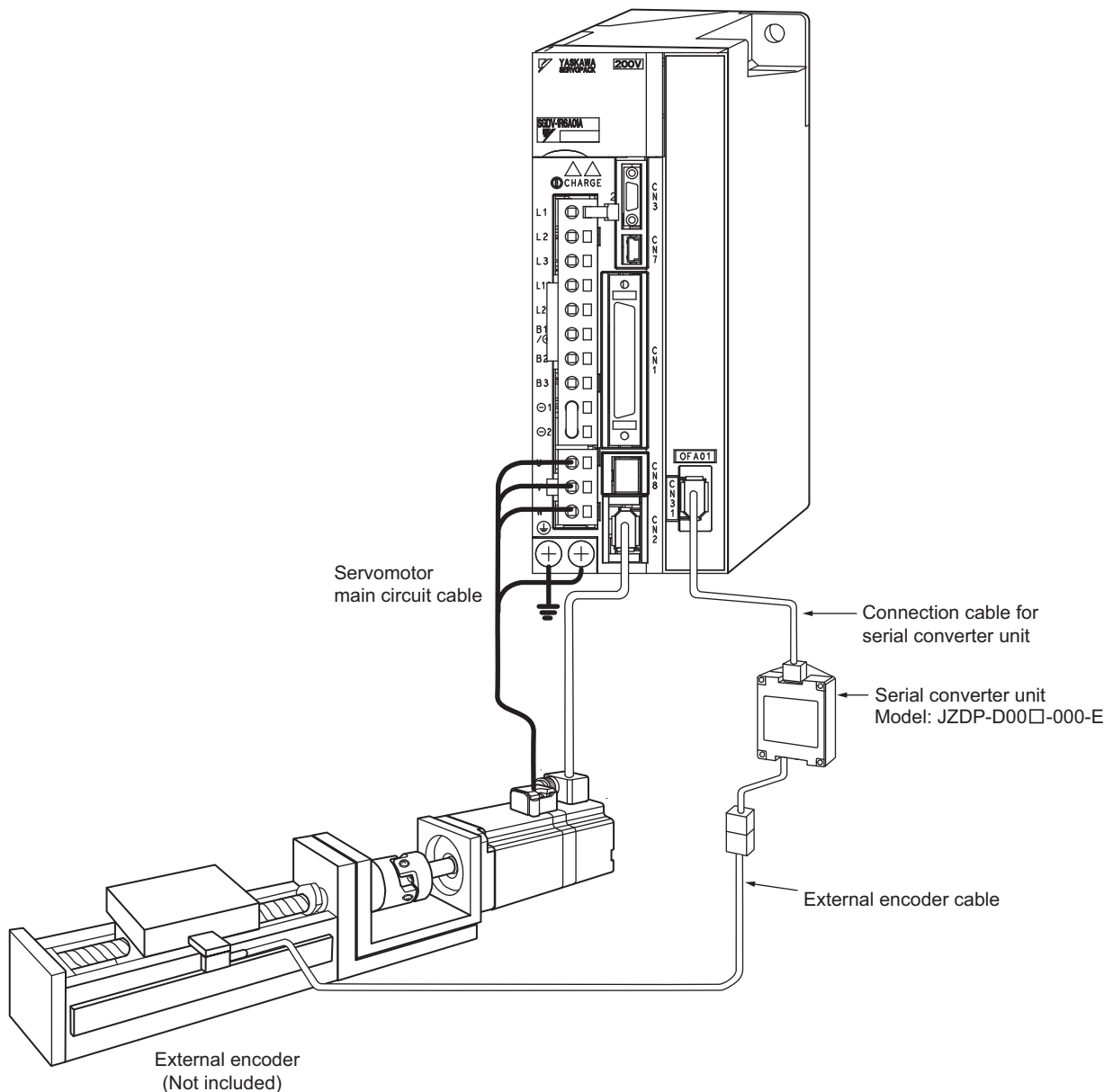

- Note 1. The figure above shows a connection example of an external encoder. Refer to *1.5 Examples of Servo System Configurations* for details on the power supply and peripheral devices.
2. In fully-closed loop control, rattling or twisting of mechanical parts may cause vibration, delaying the positioning process.

9.1.2 Internal Block Diagram of Fully-closed Loop Control

Internal block diagram of fully-closed loop control is shown below.

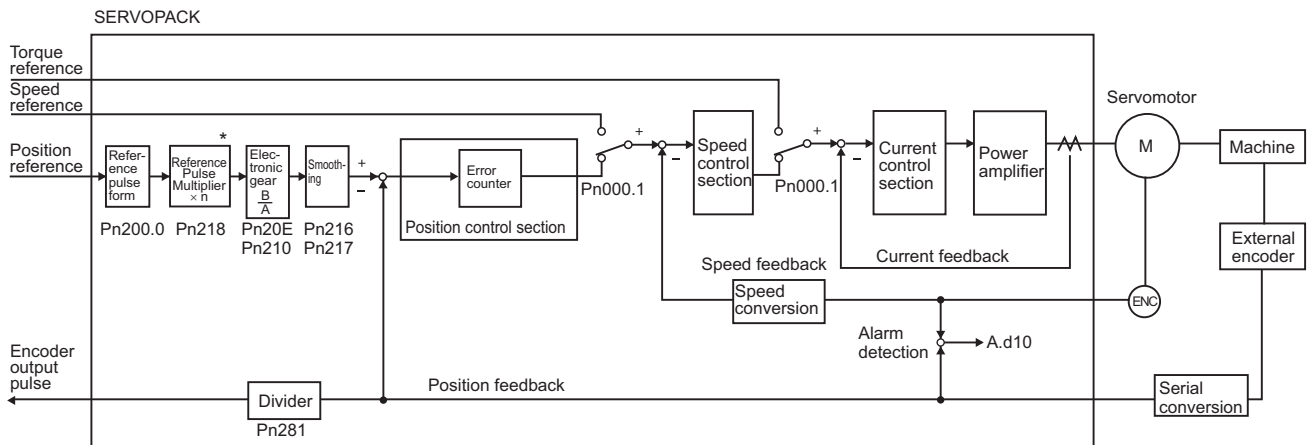

* The reference pulse input multiplication switching function is supported by software version 001A or later.

9.1.3 Serial Converter Unit

This section provides the specification of the serial converter unit.

(1) Model: JZDP-D00□-□□□-E

■ Characteristics and Specifications

Items		Specifications
Electrical Characteristics	Power Supply Voltage	+5.0 V±5%, ripple content 5% max.
	Current Consumption *1	120 mA Typ. 350 mA max.
	Signal Resolution	1/256 pitch (1 cycle) of input 2-phase sine wave pitch
	Max. Response Frequency	250 kHz
	Analog Input Signals *2 (cos, sin, Ref)	Differential input amplitude: 0.4 V to 1.2 V Input signal level: 1.5 V to 3.5 V
	Output Signal *3	Position data, alarms
	Output Method	Serial data communications
Mechanical Characteristics	Output Circuit	Balanced type transceiver (SN75LBC176 or the equivalent), internal terminating resistor: 120 Ω
	Approx. Mass	150 g
	Vibration Resistance	98 m/s ² max. (10 to 2500 Hz) in three directions
Environmental Conditions	Shock Resistance	980 m/s ² , (11 ms) two times in three directions
	Surrounding air Temperature	0 °C to 55 °C
	Storage Temperature	-20°C to +80 °C
	Humidity	20% to 90%RH (without condensation)
	Altitude	1000 m max.

* 1. The current consumption of the external encoder is not included in this value.

The current consumption of the external encoder must be taken into consideration for the current capacity of host controller that supplies the power.

* 2. Input a value within the specified range. Otherwise, incorrect position information is output, and the device may be damaged.

* 3. The transmission is enabled 100 to 300 ms after the power turns ON.

(2) Analog Signal Input Timing

When the cos and sin signals are shifted 180 degrees, the differential signals are produced as the /cos and /sin signals. The specifications of the cos, /cos, sin, and /sin signals are identical except for the phase.

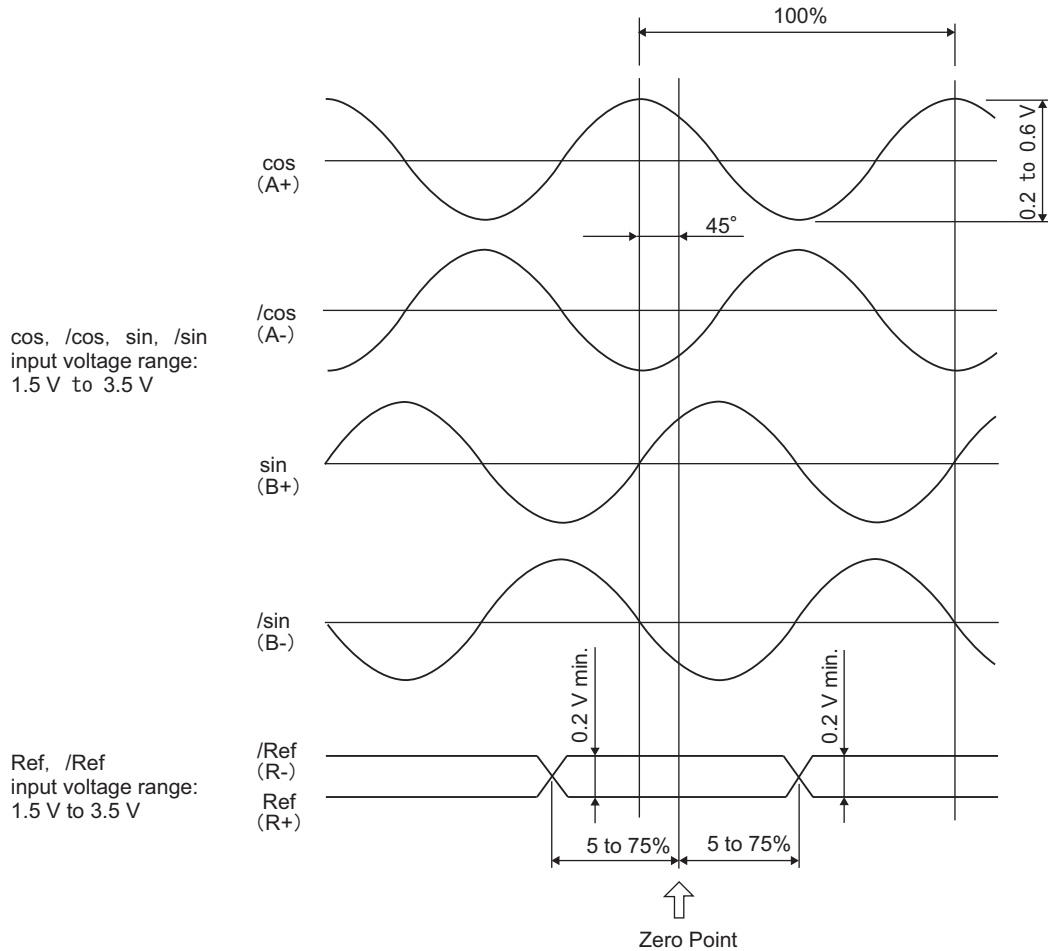

IMPORTANT

- Never perform insulation resistance and withstand voltage tests.
- When low-voltage analog signals are input to the serial converter unit, noise influence on the analog signals affects the unit's ability to output correct position information. The analog cable must be as short as possible and shielded.
- Do not connect or disconnect the unit while power is being supplied, or the unit may be damaged.
- When using multiple axes, use a shielded cable for each axis. Do not use a shielded cable for multiple axes.

9.1.4 Example of Connections to External Encoders

(1) External Encoder by Heidenhain

■ Model: LIDA□8□, LIF48□

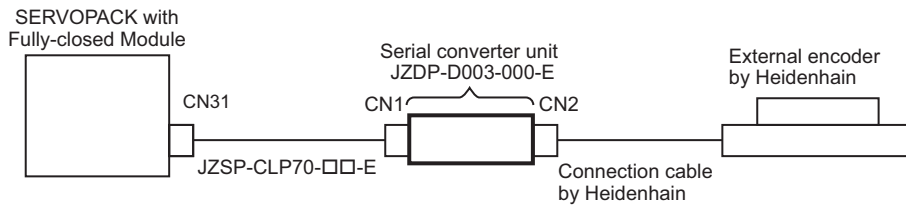

■ Model: LIC4100-series Model

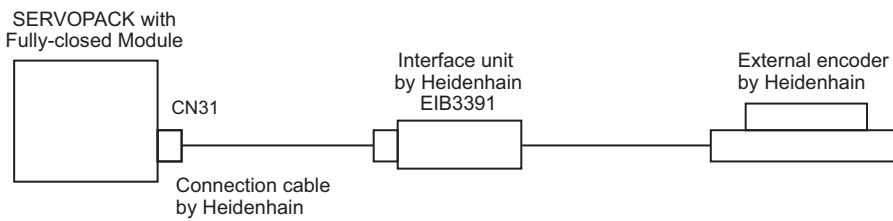

(2) External Encoder by Renishaw plc

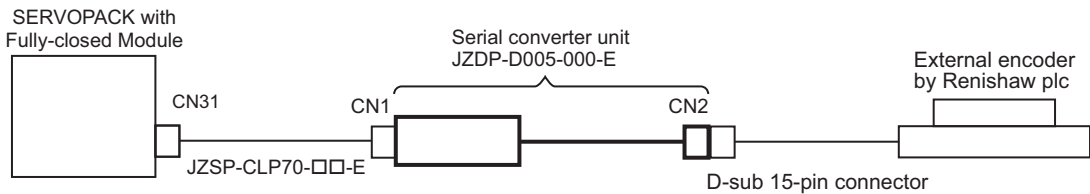

(3) External Encoder by Mitutoyo Corporation

The serial converter unit is not needed when using the external encoder made by Mitutoyo Corporation. This external encoder is an absolute encoder.

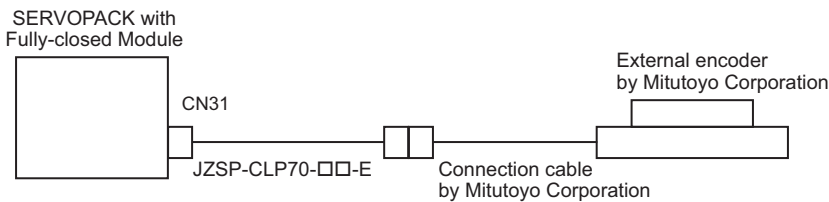

(4) External Encoder by Magnescale Co., Ltd.

■ Model: SR75, SR85, SR77*1, SR87*1, RU77*2

The serial converter unit is not needed when using the external encoder made by Magnescale Co., Ltd.

*1. The SR77 and SR87 models are external absolute encoder.

*2. The RU77 is rotational external absolute encoder.

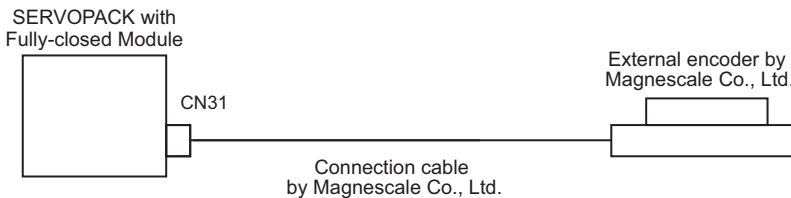

■ Model: SL700, SL710, SL720, SL730

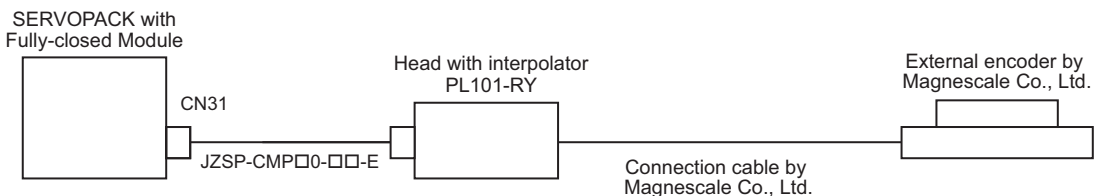

9.1.5 Encoder Output Pulse Signals from SERVOPACK with an External Encoder by Renishaw plc

The output position of the zero point signal (Ref) will depend on the direction of movement for some models of external encoders by Renishaw plc.

In such case, the phase-C pulses of the SERVOPACK are output at two positions.

For details on the specifications of the zero-point signals for a external encoder, refer to the manual for the Renishaw external encoder.

(1) When Passing 1st Zero Point Signal (Ref) in Forward Direction and Returning after Power ON

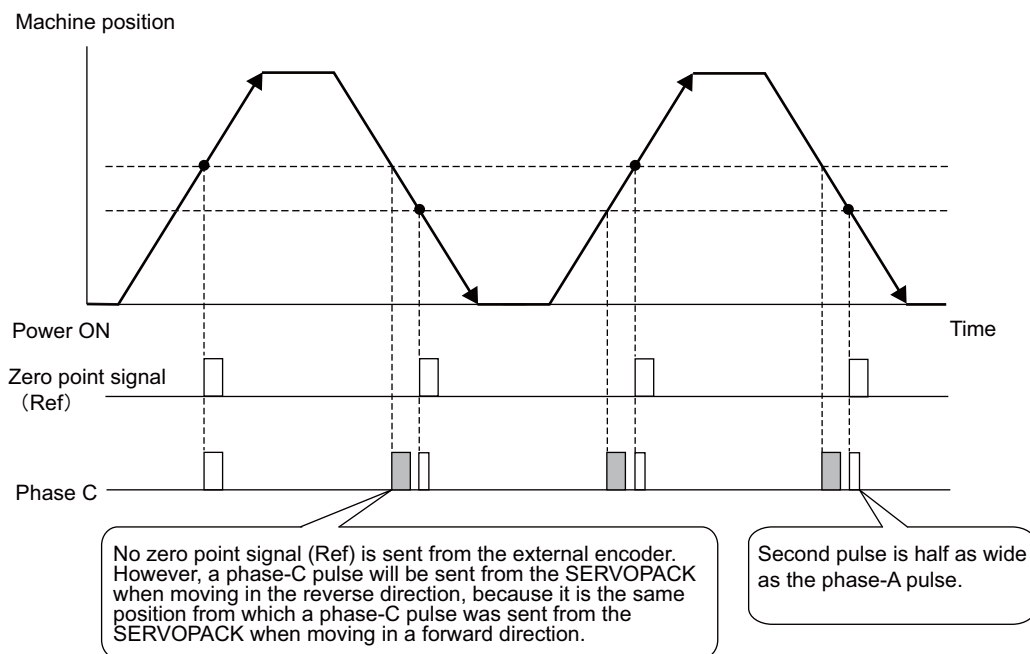

(2) When Passing 1st Zero Point Signal (Ref) in Reverse Direction and Returning after Power ON

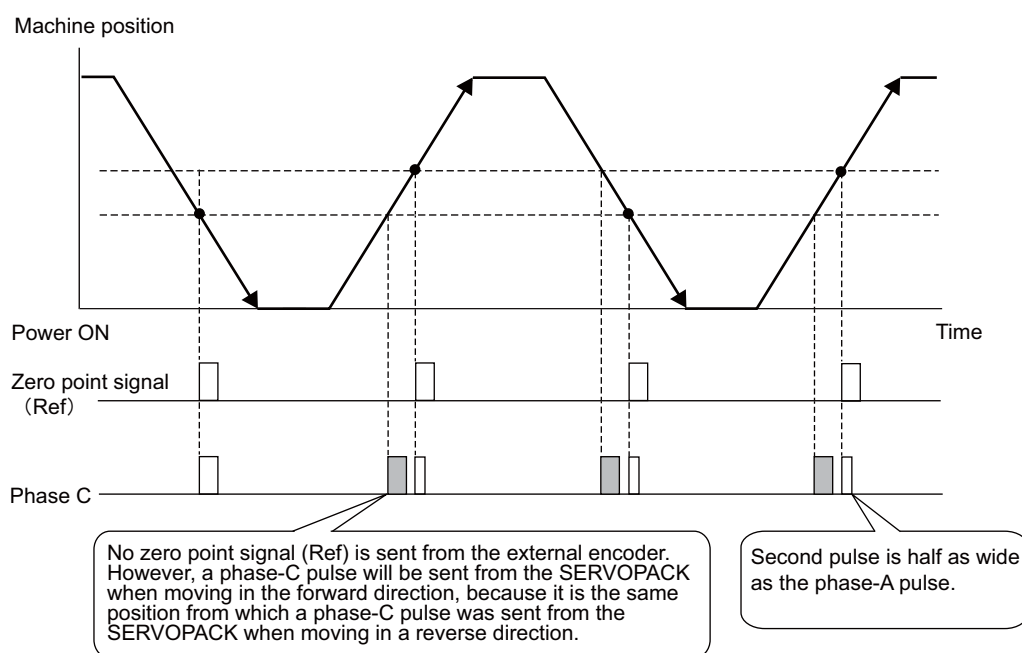

9.1.6 Precautions When Using an External Incremental Encoder by Magnescale

When an external incremental encoder by Magnescale Co., Ltd. is used, the count direction of the encoder determines if a phase-C pulse (CN1-19, CN1-20) is output and counted.

Note: The count direction (counting up or down) of the encoder determines if a phase-C pulse is output. The output of the pulse does not depend on the settings of these parameters: Pn000.0 (motor rotational direction) and Pn002.3 (external encoder usage method).

Model	Interpolator	Scale pitch (μm)
SL710	PL101-RY	800
SL720		800
SL730		800
SR75		80
SR85		80

■ When Passing 1st Zero Point in Forward Direction and Returning after Power ON

After the power is turned on, the phase-C pulse (CN1-19, CN1-20) is output when the external encoder moves forward and its detection head first passes the phase-C detection position. After the detection head of the encoder passes the detection position in a forward direction, the phase-C pulse is output when the head passes the position regardless of the direction of the encoder's movement.

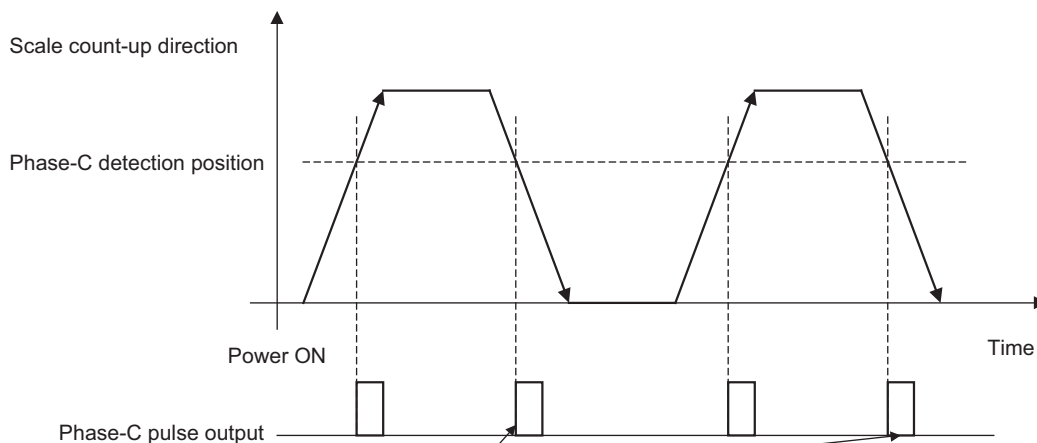

The phase-C pulse is also output when the detection head of the encoder passes this point in reverse, because the SERVOPACK has recorded the position where the phase-C pulse was originally output when first passing the position in the forward direction.

■ When Passing 1st Zero Point in Reverse Direction and Returning after Power ON

After the power is turned on, the phase-C pulse (CN1-19, CN1-20) is not output when the external encoder moves reverse and its head first passes the phase-C detection position. The phase-C pulse is output for the first time when the external encoder moves forward and its head passes the detection position. After the detection head of the encoder first passes the detection position in the forward direction, the phase-C pulse is output when the head passes the position regardless of the direction of the encoder's movement.

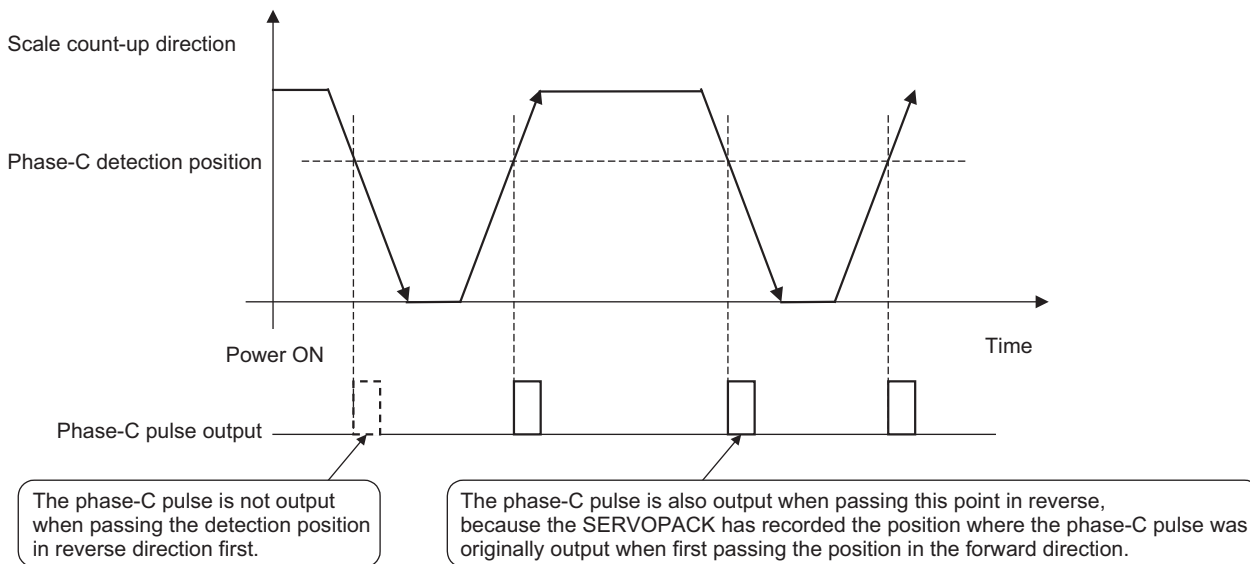

■ When Using an External Encoder with Multiple Zero Points and Passing 1st Zero Point in Forward Direction and Returning after Power ON

When using an external encoder with multiple zero points, the same logic as that explained earlier for an encoder with only one zero point applies to each zero point.
See ■ *When Passing 1st Zero Point in Forward Direction and Returning after Power ON.*

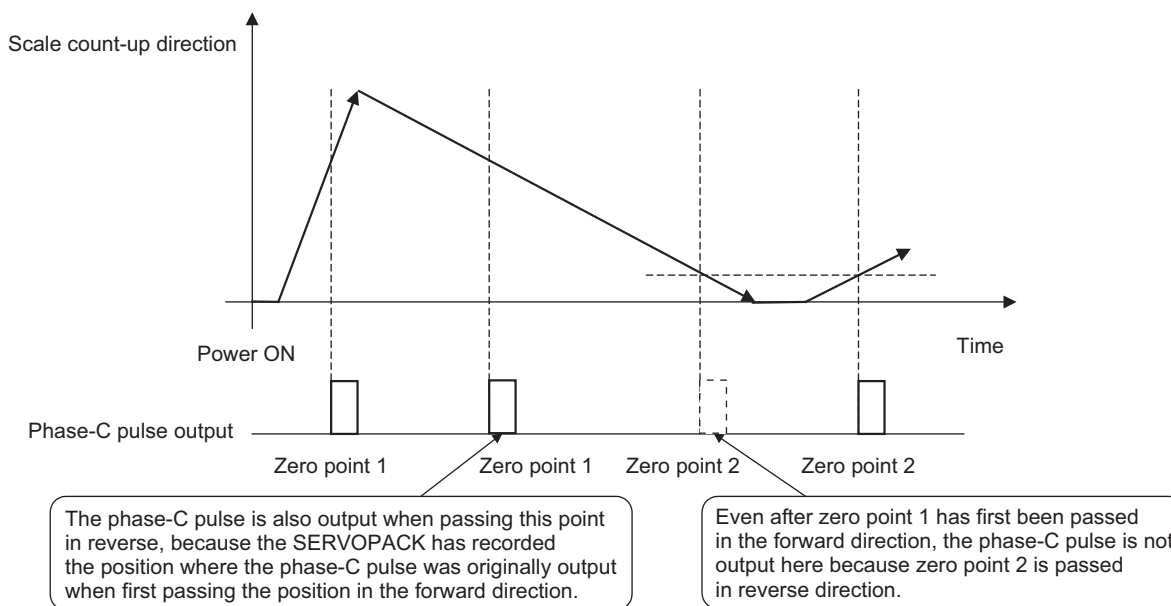

■ When Using an External Encoder with Multiple Zero Points and Passing 1st Zero Point in Reverse Direction and Returning after Power ON

When using an external encoder with multiple zero points, the same logic as that explained earlier for an encoder with only one zero point applies to each zero point.
See ■ *When Passing 1st Zero Point in Reverse Direction and Returning after Power ON.*

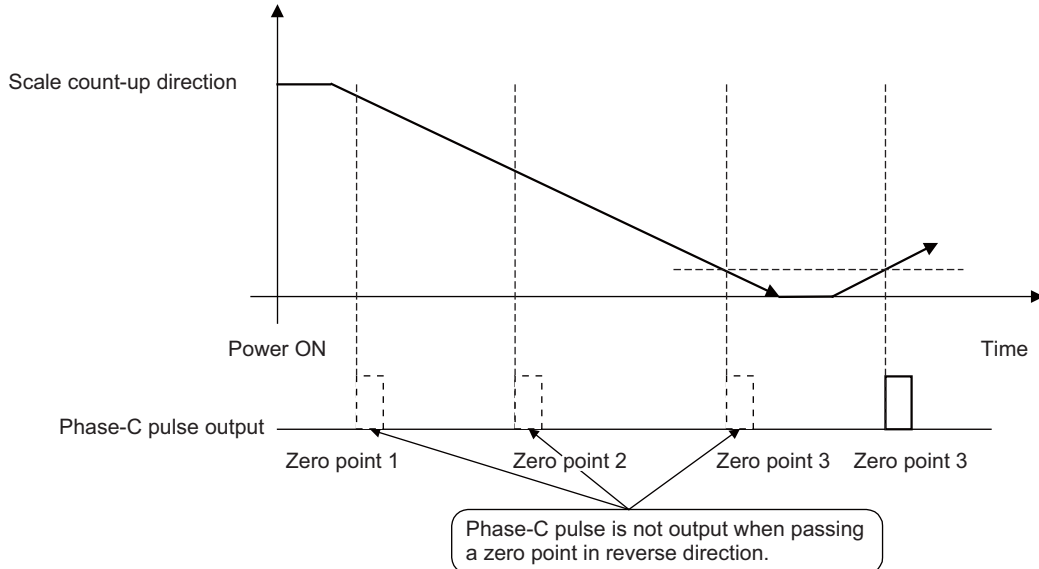

To output the phase-C pulse when a detection point is passed in reverse, set the following parameter to 1.

Parameter	Meaning	When Enabled	Classification
Pn081	n.□□□0 [Factory Setting]	Outputs phase-C pulse only in forward direction.	After restart Setup
	n.□□□1	Outputs phase-C pulse in forward and reverse direction.	

Note: A SERVOPACK with software version 0023 or later supports this parameter.



IMPORTANT

- Setting of Pn081.0
Do not change the factory setting if the zero point position of the existing equipment must remain as is.
- When Pn081.0 = 1, the width of the phase-C pulse output is narrower than that of the phase-A pulse in some cases.
- As shown in the following figure, there is a one-eighth scale pitch difference in positions between the two settings (Pn081.0 = 1 and Pn081.0 = 0) for the phase-C pulse output.

Moves to forward →

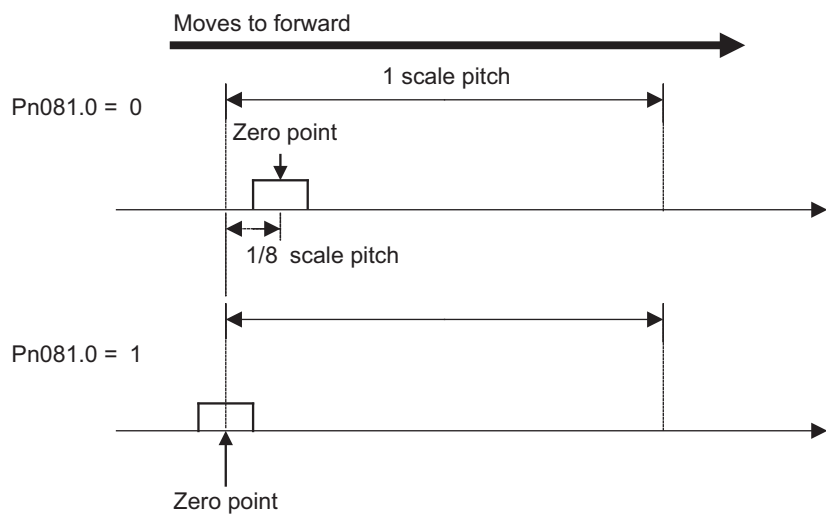

9.2 SERVOPACK Startup Procedure

First check that the SERVOPACK operates correctly with semi-closed loop control, then check that it operates correctly with fully-closed loop control.

The following describes the startup procedure for the SERVOPACK in fully-closed loop control.

Procedure	Description	Operation	Parameters Requiring Settings	Controller
1	<p>Check operation of the whole sequence in semi-closed loop control and without any load.</p> <p>Items to Check</p> <ul style="list-style-type: none"> • Power supply circuit wiring • Servomotor wiring • Encoder wiring • Wiring of I/O signal lines from the host controller • Servomotor rotation direction, speed, and number of rotations • Operation of safety mechanisms, such as the brakes and the overtravel mechanism 	<p>Set the parameters so that the SERVOPACK operates correctly in semi-closed loop control (Pn002.3 = 0) without any load and check the following points.</p> <ul style="list-style-type: none"> • Is there an error with the SERVOPACK? • Does the JOG operation operate correctly when operating the SERVOPACK in standalone mode? • Do the I/O signals turn ON/OFF correctly? • Does the servomotor turn ON when the servo ON signal is input? • Does the servomotor operate correctly when the position reference is input by the host controller? 	<ul style="list-style-type: none"> • Basic Function Select Switch 0 (Pn000) • Application Function Select Switch 1 (Pn001) • External Encoder Usage (Pn002.3) • Electronic Gear Ratio (Numerator) (Pn20E) • Electronic Gear Ratio (Denominator) (Pn210) • Input Signal Selection (Pn50A, Pn50B, Pn511) • Output Signal Selection (Pn50E, Pn50F, Pn510) 	SERVOPACK or host controller
2	<p>Check operation of the system connected with the machine and servomotor in semi-closed loop control mode.</p> <p>Items to Check</p> <ul style="list-style-type: none"> • Initial responsiveness of the system connected with the machine • Movement direction, distance, and speed of the machine specified by the host controller 	<p>Connect the servomotor to the machine.</p> <p>Set the moment of inertia ratio (Pn103) using the advanced auto-tuning function.</p> <p>Check that the machine operates in the correct direction, distance, and speed as directed by the host controller.</p>	<ul style="list-style-type: none"> • Moment of inertia ratio (Pn103) 	Host controller
3	<p>Check the external encoder.</p> <p>Item to Check</p> <ul style="list-style-type: none"> • Are signals from the external encoder received correctly? 	<p>Set parameters related to the fully-closed loop control and move the machine with your hand without turning ON the power supply to the servomotor. Check the following status with the digital operator or SigmaWin+.</p> <ul style="list-style-type: none"> • Does the fully-closed feedback pulse counter (Un00E) count up when the servomotor moves in the forward direction? • Is the distance the machine moved about visually the same as the amount counted by the fully-closed feedback pulse counter (Un00E)? <p>Note: The unit for fully-closed feedback pulse counter (Un00E) is one pulse, which is equivalent to the external encoder sine wave pitch divided by the number of divisions*.</p> <p>* Refer to 9.3.5 <i>Electronic Gear</i> for details on the number of divisions.</p>	<ul style="list-style-type: none"> • External Encoder Usage (Pn002.3) • Number of External Scale Pitch (Pn20A) • Electronic Gear Ratio (Numerator) (Pn20E) • Electronic Gear Ratio (Denominator) (Pn210) • Encoder Output Resolution (Pn281) • Excessive Error Level Between Servomotor and Load Positions (Pn51B) • Positioning Completed Width (Pn522) • Multiplier per One Fully-closed Rotation (Pn52A) 	—

(cont'd)

Procedure	Description	Operation	Parameters Requiring Settings	Controller
4	Perform a program JOG operation. Items to Check <ul style="list-style-type: none"> Does the fully-closed loop control operate correctly when operating the SERVOPACK in standalone mode? 	Perform a program JOG operation and check that the distance that the servomotor moved is the same as the distance that is set in Pn531. Note: Start from a low speed and gradually increase the speed.	<ul style="list-style-type: none"> Program JOG related parameters (Pn530 to Pn536) 	SERVOPACK
5	Operate the SERVOPACK. Items to Check <ul style="list-style-type: none"> Does the fully-closed loop control operate correctly including the host controller? 	Input the position reference and check that the SERVOPACK operates correctly. Note: Start from a low speed and gradually increase the speed.	–	Host controller

9.3 Parameter Settings for Fully-closed Loop Control

This section describes the parameter settings for fully-closed loop control.

Set Parameters	Setting Contents	Position Control	Speed Control	Torque Control	Reference
Pn000.0	Motor rotation direction	○	○	○	9.3.1
Pn002.3	External encoder usage method	○	○	○	
Pn20A	Number of pitches for the external encoder	○	○	○	9.3.2
Pn281	Number of encoder output pulses (PAO, PBO, and PCO) from the SERVOPACK	○	○	○	9.3.3
–	External absolute encoder data reception sequence	○	○	○	9.3.4
Pn20E, Pn210	Electronic gear ratio	○	–	–	9.3.5
Pn51B	Excessive error level between servomotor and load positions	○	–	–	9.3.6
Pn52A	Multiplier per one fully-closed rotation	○	–	–	
Pn006/Pn007	Analog monitor signal	○	○	○	9.3.7
Pn22A	Speed feedback method during fully-closed loop control	○	–	–	9.3.8

Note: When using an external absolute encoder, this external encoder works as an absolute encoder even if Pn002.2 is set to 1.

Parameter		Meaning	When Enabled	Classification
Pn002	n.□0□□ [Factory setting]	Uses the absolute encoder as an absolute encoder.	After restart	Setup
	n.□1□□	Uses the absolute encoder as an incremental encoder.		

9.3.1 Motor Rotation Direction

The motor rotation direction can be set. To perform fully-closed loop control, it is necessary to set the motor rotation direction with both Pn000.0 (motor rotation direction) and Pn002.3 (external encoder usage).

(1) Setting Parameter Pn000.0

The standard setting for forward rotation is counterclockwise (CCW) as viewed from the load end of the servomotor.

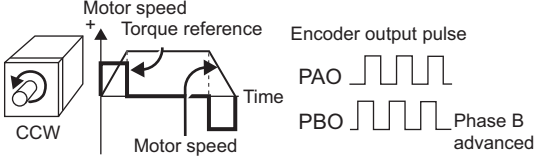
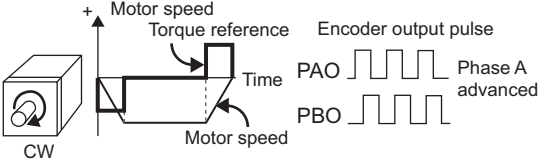
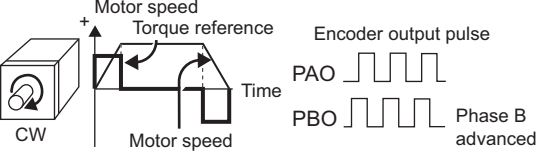
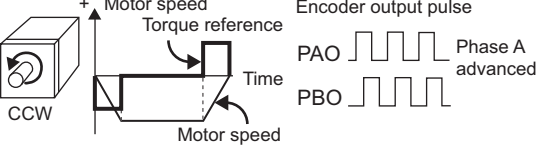
Parameter	Forward/Reverse Reference	Direction of Motor Rotation and Encoder Output Pulse	Applicable Overtravel (OT)
Pn000	n.□□□0 Sets CCW as forward direction. [Factory setting]	Forward Reference 	P-OT
		Reverse Reference 	N-OT
	n.□□□1 Sets CW as forward direction. (Reverse Rotation Mode)	Forward Reference 	P-OT
		Reverse Reference 	N-OT

Note: SigmaWin+ trace waveforms are shown in the above table.

(2) Setting Parameter Pn002.3

Parameter	Name	Meaning	When Enabled	Classification	
Pn002	n.0□□□ [Factory setting]	External Encoder Usage	Do not use external encoder.*	After restart	Setup
	n.1□□□		Uses external encoder in forward rotation direction.		
	n.2□□□		Reserved (Do not change.)		
	n.3□□□		Uses external encoder in reversed rotation direction.		
	n.4□□□		Reserved (Do not change.)		

* The mode will be switched to semi-closed position control if Pn002.3 is set to 0.

(3) Relation between Motor Rotation Direction and External Encoder Pulse Phases

Refer to the table below.

Parameter			Pn002.3 (External Encoder Usage)			
			1		3	
Pn000.0 (Motor rotation direction)	0	Reference direction	Forward reference	Reverse reference	Forward reference	Reverse reference
		Motor rotation direction	CCW	CW	CCW	CW
		External encoder output	cos lead	sin lead	sin lead	cos lead
		Encoder output pulse	Phase B lead	Phase A lead	Phase B lead	Phase A lead
	1	Reference direction	Forward reference	Reverse reference	Forward reference	Reverse reference
		Motor rotation direction	CW	CCW	CW	CCW
		External encoder output	sin lead	cos lead	cos lead	sin lead
		Encoder output pulse	Phase B lead	Phase A lead	Phase B lead	Phase A lead

- Set Pn002.3 to 1 (forward rotation with forward reference) if the output of the external encoder is cos lead and the motor is turning counterclockwise; set Pn002.3 to 3 (reverse rotation with forward reference) if it is sin lead. When Pn000.0 is set to 0 and Pn002.3 to 1, manually turn the motor shaft counterclockwise. If the fully-closed feedback pulse counter (Un00E) counts up, set Pn002.3 to 1. If the Un00E counts down, set Pn002.3 to 3.
- The output pulses are phase-B advanced if the motor is turning forward regardless of the setting in Pn000.0.

9.3.2 Sine Wave Pitch (Frequency) for an External Encoder

Set the number of external encoder pitches per motor rotation to Pn20A.

Pn20A is the speed conversion coefficient when the external encoder is used as speed feedback.

(1) Setting Example

Specifications External encoder sine wave pitch: 20 μm Ball screw lead: 30 mm

If the external encoder is connected directly to the motor, the set value will be 1500 (30 mm/0.02 mm = 1500).

- Note 1. If there is a fraction, round off the digits below the decimal point.
- 2. If the number of external encoder pitches per motor rotation is not an integer, there is some error in the speed loop. This is not relevant for the position loop however, therefore it does not interfere with the position accuracy.

(2) Related Parameter

Pn20A	Number of External Scale Pitch Position				Classifica- tion
	Setting Range	Setting Unit	Factory Setting	When Enabled	
	4 to 1048576	1 pitch/rev	32768	After restart	Setup

9.3.3 Setting Encoder Output Pulses (PAO, PBO, and PCO)

Set the position resolution to Pn281. Set the number of phase A and phase B edges.

(1) Setting Example

Specifications External encoder sine wave pitch: 20 μm Ball screw lead: 30 mm Speed: 1600 mm/s

If the output of a single pulse (multiplied by 4) is 1 μm, the set value will be 20.

If the output of a single pulse (multiplied by 4) is 0.5 μm, the set value will be 40.

The encoder output pulse will have the following waveform if the set value is 20.

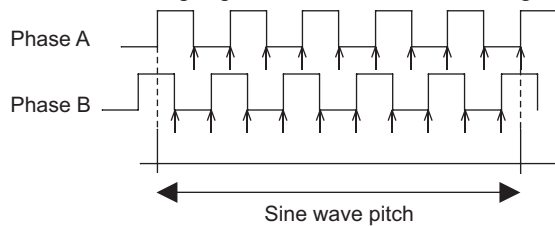

"↑" shows the edge position. In this example, the set value is 20 therefore the number of ↑ is 20.

Note: The upper limit of the encoder signal output frequency (multiplied by 4) is 6.4 Mpps. Do not set a value that would cause the output to exceed 6.4 Mpps. If the output exceeds the upper limit, the overspeed of encoder output pulse rate alarm (A.511) will be output.

Example:
The frequency is as follows if the set value is 20 and the speed is 1600 mm/s:

$$\frac{1600 \text{ mm/s}}{0.001 \text{ mm}} = 1600000 = 1.6 \text{ Mpps}$$

Because 1.6 Mpps is less than 6.4 Mpps, this value can be used.

(2) Related Parameter

Pn281	Encoder Output Resolution Position				Classification
	Setting Range	Setting Unit	Factory Setting	When Enabled	
	1 to 4096	1 edge/pitch	20	After restart	Setup

Note: The maximum setting for the encoder output resolution is 4096. When the number of divisions on the external encoder is more than 4096, the data shown in 9.3.5 ■ External Encoder Sine Wave Pitch and Number of Divisions is no longer applicable.

(3) Phase-C Pulse Output Specifications

The pulse width of phase C (origin pulse) varies according to the encoder output resolution (Pn281), and will become the same as the pulse width of phase A.

Output timing for the phase-C pulse is one of the following.

- In synchronization with the phase-A rising edge
- In synchronization with the phase-A falling edge
- In synchronization with the phase-B rising edge
- In synchronization with the phase-B falling edge



IMPORTANT Phase C of the rotational external absolute encoder is output only at the encoder's first point of origin after the power is supplied. Phase C of the external encoder is not output every rotation.

9.3.4 External Absolute Encoder Data Reception Sequence

The sequence in which the SERVOPACK receives outputs from the external absolute encoder and transmits them to host controller in fully-closed loop control is shown below.

(1) Outline of Absolute Signals

The serial data, pulses, etc., of the external absolute encoder that are output from the SERVOPACK are output from the PAO, PBO, and PCO signals as shown below.

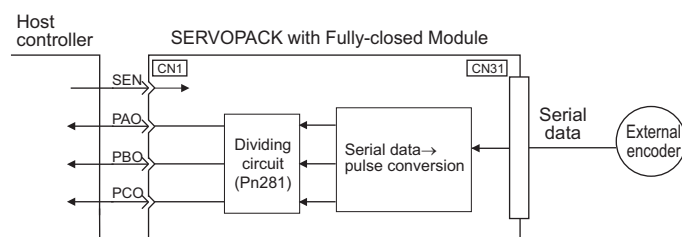

Signal Name	Status	Contents
PAO	At initialization	Serial data Initial incremental pulses
	Normal Operations	Incremental pulses
PBO	At initialization	Initial incremental pulses
	Normal Operations	Incremental pulses
PCO	Always	Origin pulses

Note: When host controller receives the data from the external absolute encoder, do not perform counter reset using the output of PCO signal.

(2) Absolute Data Transmission Sequence and Contents

1. Set the SEN signal at ON (high level).
2. After 100 ms, set the system to serial data reception-waiting-state. Clear the incremental pulse up/down counter to zero.
3. Receive eight characters of serial data.
4. The system enters a normal incremental operation state about 400 ms after the last serial data is received.

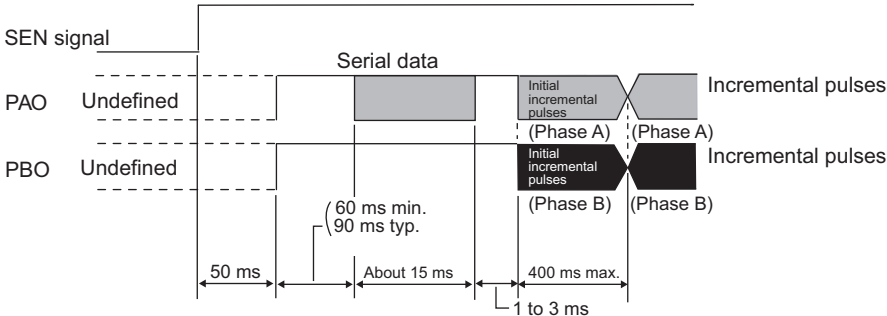

Serial data:
The current position pulses divided by Pn281 are output in serial data. One serial data is a value equivalent to 1048576 pulses.

Initial incremental pulses:
The current position pulses divided by Pn281 are output in pulses. The number of output pulses is between 0 to 1048576, and the output speed is approximately 1.48 μs per pulse.

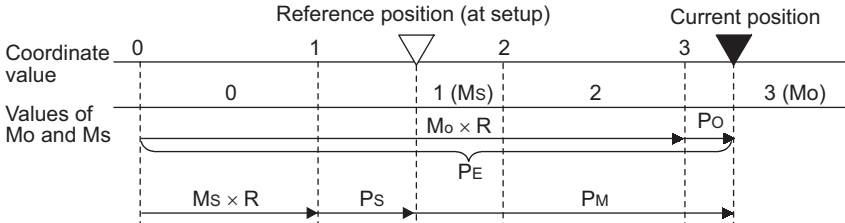

Final absolute data P_M is calculated by following formula.

$$P_E = M_O \times R + P_O$$

$$P_M = P_E - M_S \times R - P_S$$

Signal	Meaning
P_E	Current position of external encoder
M_O	Serial data of current position
P_O	Number of initial incremental pulses of current position
M_S	Serial data of reference position
P_S	Number of initial incremental pulses of reference position
P_M	Current value required for the user's system
R	1048576

Note: If host controller receives the data from the external absolute encoder, do not perform counter reset using the output of PCO signal.

(3) Serial Data Specifications

The serial data is output from the PAO signal.

Data Transfer Method	Start-stop Synchronization (ASYNC)
Baud rate	9600 bps
Start bits	1 bit
Stop bits	1 bit
Parity	Even
Character code	ASCII 7-bit code
Data format	<p>8 characters, as shown below.</p> <p>Note: 1. Data is "P+00000" (CR) or "P-00000" (CR) when the position is zero. 2. The serial data range is "-32768" to "+32767". When this range is exceeded, the data changes from "+32767" to "-32678" or from "-32768" to "+32767." When changing multiturn limit, the range changes. For details, refer to 5.9.6 Multiturn Limit Setting.</p>

(4) Transferring Alarm Contents

If an external absolute encoder is used, the contents of alarms detected by the SERVOPACK are transmitted in serial data to the host controller from the PAO output when the SEN signal changes from high level to low level.

Note: The SEN signal cannot be OFF while the servomotor power is ON.

Output example of alarm contents are as shown below.

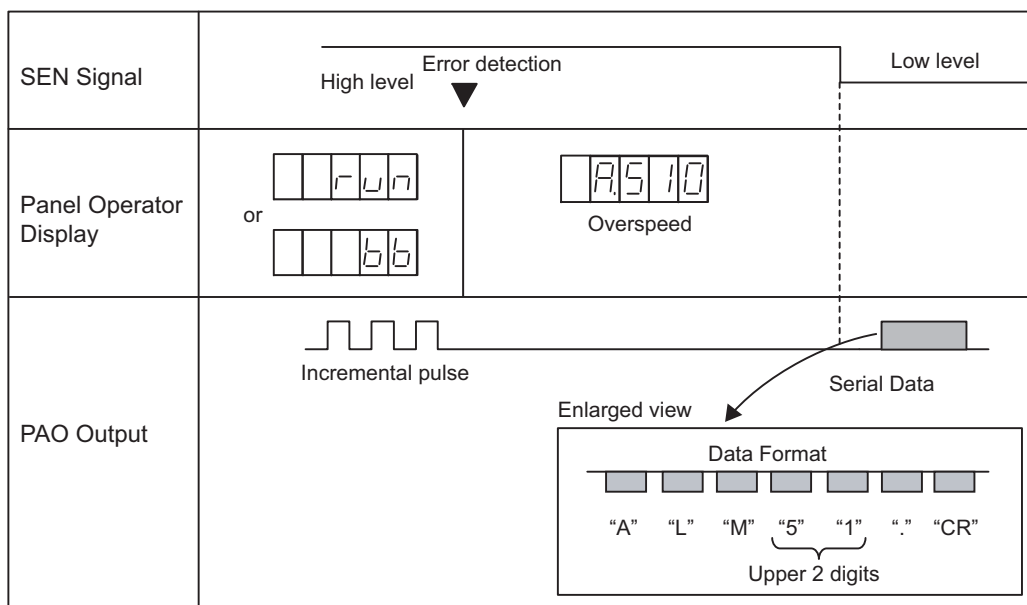

9.3.5 Electronic Gear

Refer to 5.4.4 *Electronic Gear* for the purpose of setting the electronic gear.

The following formula is used to calculate the electronic gear ratio in fully-closed loop control.

$$\text{Electronic gear ratio} = \frac{B}{A} = \frac{Pn20E}{Pn210} = \frac{\text{Travel distance per reference unit} \times \text{Number of divisions}}{\text{External encoder sine wave pitch}}$$

Note: Set Pn20E (numerator B) and Pn210 (denominator A) to integral values.

The setting range is defined by $0.001 \leq \frac{B}{A} \leq 4000$.

The following table shows the various external encoder sine wave pitches and the number of divisions.

■ External Encoder Sine Wave Pitch and Number of Divisions

Calculate the electronic gear ratio with the values in the following table.

Type of External Encoder	Manufacturer	External Encoder Model	Sine Wave Pitch [μm]	Model of Relay Device between SERVOPACK and External Encoder	Number of Divisions	Resolution
Incremental	Heidenhain	LIDA48□	20	JZDP-D003-□□□□-E*1	256	0.078 μm
		LIDA18□	40	JZDP-D003-□□□□-E*1	256	0.156 μm
		LIF48□	4	JZDP-D003-□□□□-E*1	256	0.016 μm
	Renishaw plc	RGH22B	20	JZDP-D005-□□□□-E*1	256	0.078 μm
	Magnescale Co., Ltd.	SR75-□□□□□LF*2	80	—	8192	0.0098 μm
		SR75-□□□□□MF	80	—	1024	0.078 μm
		SR85-□□□□□LF*2	80	—	8192	0.0098 μm
		SR85-□□□□□MF	80	—	1024	0.078 μm
		SL700*2, SL710*2, SL720*2, SL730*2	800	PL101-RY*3	8192	0.0977 μm
	Absolute	Heidenhain	LIC4100	20.48	EIB3391Y*4	4096
Mitutoyo Corporation		ST781A/ST781AL	256	—	512	0.5 μm
		ST782A/ST782AL	256	—	512	0.5 μm
		ST783/ST783AL	51.2	—	512	0.1 μm
		ST784/ST784AL	51.2	—	512	0.1 μm
		ST788A/ST788AL	51.2	—	512	0.1 μm
		ST789A/ST789AL*5	25.6	—	512	0.05 μm
Magnescale Co., Ltd.		SR77-□□□□□LF*2	80	—	8192	0.0098 μm
		SR77-□□□□□MF	80	—	1024	0.078 μm
		SR87-□□□□□LF*2	80	—	8192	0.0098 μm
		SR87-□□□□□MF	80	—	1024	0.078 μm
		RU77-4096ADF*6	—	—	256	20 bits
	RU77-4096AFFT01*6	—	—	1024	22 bits	

*1. Models for serial converter units.

*2. When using the encoder pulse output with these external encoders, the setting range of Pn281 is restricted. For details, refer to 9.3.3 *Setting Encoder Output Pulses (PAO, PBO, and PCO)*.

*3. Model for sensor head with interpolator.

*4. Model for interface unit by Heidenhain.

*5. For details on this external encoder, contact Mitutoyo.

*6. Model for rotational external encoder.

Refer to the manuals for the external encoder and serial converter unit for details on the sine wave pitch and the number of divisions of the external encoder.

■ Setting Example

If the servomotor moves 0.2 μm for every pulse of position reference, the external encoder sine wave pitch is 20 μm, and the number of divisions is 256, the electronic gear ratio will be as follow.

$$\text{Electronic gear ratio } \frac{B}{A} = \frac{Pn20E}{Pn210} = \frac{0.2 \times 256}{20} = \frac{512}{200}$$

Therefore, set 512 for Pn20E (numerator B) and 200 for Pn210 (denominator A).

9.3.6 Alarm Detection

The setting of alarm detection (Pn51B/Pn52A) is shown below.

(1) Excessive Error Level between Servomotor and Load Positions (Pn51B)

This setting detects the difference between the feedback position of the motor encoder and the feedback load position of the external encoder in fully-closed loop control. If the detected difference is above the set level, the motor-load position error overflow alarm (A.d10) will be output.

Pn51B	Excessive Error Level between Servomotor and Load Positions Position				Classification
	Setting Range	Setting Unit	Factory Setting	When Enabled	
	0 to 1073741824	1 reference unit	1000	Immediately	Setup

Note: When Pn51B is set to 0, the motor-load position error overflow alarm (A.d10) is not detected.

(2) Multiplier per One Fully-closed Rotation (Pn52A)

The coefficient of the error between the external encoder and the motor per motor rotation can be set. This function can be used to prevent the motor from running out of control due to damage to the external encoder or to detect slippage of the belt.

■ Setting Example

Increase the value if the belt slips or is twisted excessively.

If the set value is 0, the external encoder value will be read as it is.

If the factory setting of 20 is used, the second rotation will start with the error for the first motor rotation multiplied by 0.8. (Refer to the following figure.)

Error between motor and external encoder

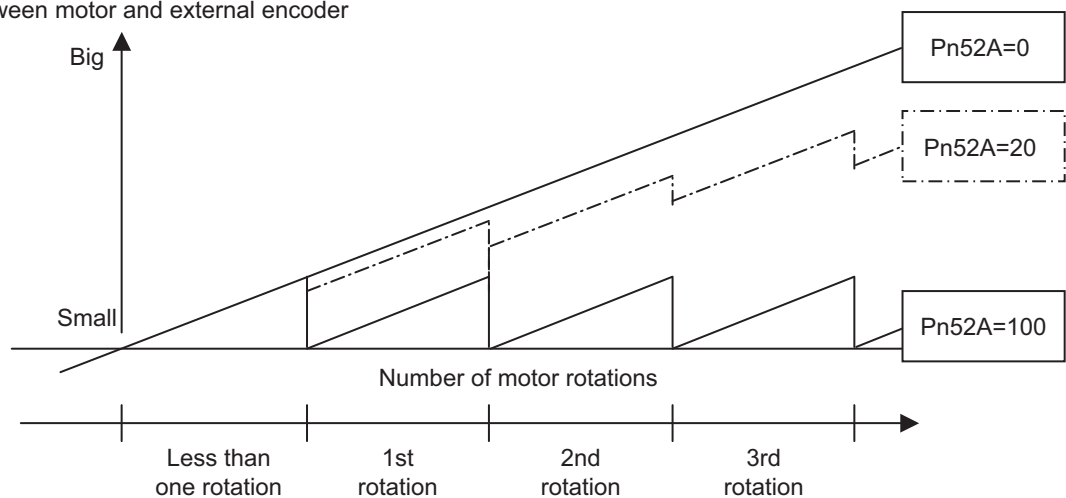

■ Related Parameter

Pn52A	Multiplier per One Fully-closed Rotation Position				Classification
	Setting Range	Setting Unit	Factory Setting	When Enabled	
	0 to 100	1%	20	Immediately	Setup

9.3.7 Analog Monitor Signal

The position error between servomotor and load can be monitored with the analog monitor.

Parameter	Name	Meaning	When Enabled	Classification
Pn006	n.□□07	Analog Monitor 1 Signal Selection Position error between servomotor and load [0.01 V/1 reference unit] Factory setting: n.□□02	Immediately	Setup
Pn007	n.□□07	Analog Monitor 2 Signal Selection Position error between servomotor and load [0.01 V/1 reference unit] Factory setting: n.□□00		

9.3.8 Speed Feedback Method during Fully-closed Loop Control

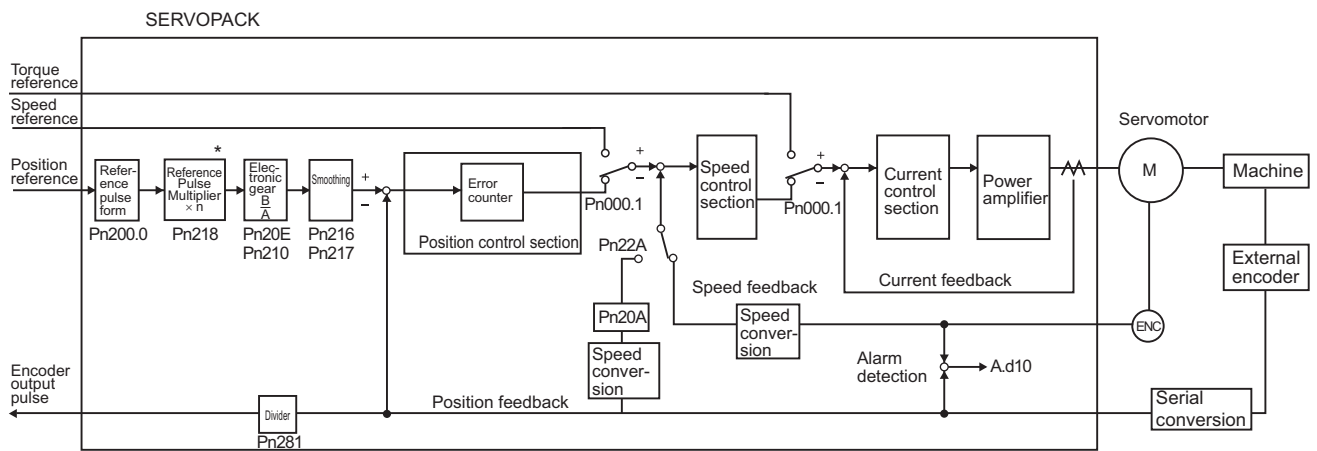

* The reference pulse input multiplication switching function is supported by software version 001A or later.

Use Pn22A.3 to select the speed feedback method during fully-closed loop control: Normally, set Pn22A.3 to 0 (Uses motor encoder speed.). Set Pn22A.3 to 1 (Uses external encoder speed.) when connecting a direct drive motor and high-resolution external encoder.

Parameter	Meaning	When Enabled	Classification
Pn22A	n.0□□□ [Factory setting]	After restart	Setup
	n.1□□□		

Note: This parameter cannot be used when Pn002.3 is set to 0.

Troubleshooting

10.1 Alarm Displays	10-2
10.1.1 List of Alarms	10-2
10.1.2 Troubleshooting of Alarms	10-6
10.2 Warning Displays	10-21
10.2.1 List of Warnings	10-21
10.2.2 Troubleshooting of Warnings	10-22
10.3 Troubleshooting Malfunction Based on Operation and Conditions of the Servomotor	10-25

10.1 Alarm Displays

The following sections describe troubleshooting in response to alarm displays.

The alarm name, alarm meaning, alarm stopping method, alarm code output, and alarm reset capability are listed in order of the alarm numbers in *10.1.1 List of Alarms*.

The causes of alarms and troubleshooting methods are provided in *10.1.2 Troubleshooting of Alarms*.

10.1.1 List of Alarms

This section provides list of alarms.

■ Servomotor Stopping Method

If an alarm occurs, the servomotor can be stopped by doing either of the following operations.

Gr.1: The servomotor is stopped according to the setting in Pn001.0 if an alarm occurs. Pn001.0 is factory-set to stop the servomotor by applying the DB.

Gr.2: The servomotor is stopped according to the setting in Pn00B.1 if an alarm occurs. Pn00B.1 is factory-set to stop the servomotor by setting the speed reference to "0." The servomotor under torque control will always use the Gr.1 method to stop. By setting Pn00B.1 to 1, the servomotor stops using the same method as Gr.1. When coordinating a number of servomotors, use this stopping method to prevent machine damage that may result due to differences in the stop method.

■ Alarm Reset

Available: Removing the cause of alarm and then executing the alarm reset can clear the alarm.

N/A: Executing the alarm reset cannot clear the alarm.

Alarm Number	Alarm Name	Meaning	Servomotor Stopping Method	Alarm Reset	Alarm Code Output		
					ALO1	ALO2	ALO3
A.020	Parameter Checksum Error 1	The data of the parameter in the SERVO-PACK is incorrect.	Gr.1	N/A	H	H	H
A.021	Parameter Format Error 1	The data of the parameter in the SERVO-PACK is incorrect.	Gr.1	N/A			
A.022	System Checksum Error 1	The data of the parameter in the SERVO-PACK is incorrect.	Gr.1	N/A			
A.030	Main Circuit Detector Error	Detection data for main circuit is incorrect.	Gr.1	Available			
A.040	Parameter Setting Error 1	The parameter setting is outside the setting range.	Gr.1	N/A			
A.041	Encoder Output Pulse Setting Error	The encoder output pulse (Pn212) is outside the setting range or does not satisfy the setting conditions.	Gr.1	N/A			
A.042	Parameter Combination Error	Combination of some parameters exceeds the setting range.	Gr.1	N/A			
A.044	Semi-closed/Fully-closed Loop Control Parameter Setting Error	The settings of the option module and Pn00B.3, Pn002.3 do not match.	Gr.1	N/A			
A.050	Combination Error	The SERVOPACK and the servomotor capacities do not match each other.	Gr.1	Available			
A.051	Unsupported Device Alarm	The device unsupported was connected.	Gr.1	N/A			
A.0b0	Cancelled Servo ON Command Alarm	The servo ON signal (/S-ON) was sent from the host controller after executing a utility function that turns ON servomotor.	Gr.1	Available			
A.100	Overcurrent or Heat Sink Overheated	An overcurrent flowed through the IGBT or the heat sink of the SERVOPACK was overheated.	Gr.1	N/A	L	H	H

(cont'd)

Alarm Number	Alarm Name	Meaning	Servo-motor Stopping Method	Alarm Reset	Alarm Code Output		
					ALO1	ALO2	ALO3
A.300	Regeneration Error	Regenerative circuit or regenerative resistor is faulty.	Gr.1	Available	L	L	H
A.320	Regenerative Overload	Regenerative energy exceeds regenerative resistor capacity.	Gr.2	Available			
A.330	Main Circuit Power Supply Wiring Error	<ul style="list-style-type: none"> Setting of AC input/DC input is incorrect. Power supply wiring is incorrect. 	Gr.1	Available			
A.400	Overvoltage	Main circuit DC voltage is excessively high.	Gr.1	Available	H	H	L
A.410	Undervoltage	Main circuit DC voltage is excessively low.	Gr.2	Available			
A.450	Main-Circuit Capacitor Overvoltage	The capacitor of the main circuit has deteriorated or is faulty.	Gr.1	N/A			
A.510	Overspeed	The servomotor speed is above the maximum rotational speed.	Gr.1	Available	L	H	L
A.511	Overspeed of Encoder Output Pulse Rate	The pulse output speed upper limit of the set encoder output pulse (Pn212) is exceeded.	Gr.1	Available			
A.520	Vibration Alarm	Incorrect vibration at the motor speed was detected.	Gr.1	Available			
A.521	Autotuning Alarm	Vibration was detected while performing tuning-less function.	Gr.1	Available			
A.710	Overload: High Load	The servomotor was operating for several seconds to several tens of seconds under a torque largely exceeding ratings.	Gr.2	Available	L	L	L
A.720	Overload: Low Load	The servomotor was operating continuously under a torque exceeding ratings.	Gr.1	Available			
A.730 A.731	Dynamic Brake Overload	When the dynamic brake was applied, rotational energy exceeded the capacity of dynamic brake resistor.	Gr.1	Available			
A.740	Overload of Surge Current Limit Resistor	The main circuit power was frequently turned ON and OFF.	Gr.1	Available			
A.7A0	Heat Sink Overheated	The heat sink of the SERVOPACK exceeded 100°C.	Gr.2	Available			
A.7AB	Built-in Fan in SERVOPACK Stopped	The fan inside the SERVOPACK stopped.	Gr.1	Available			
A.810	Encoder Backup Error	The power supplies to the encoder all failed and position data was lost.	Gr.1	N/A			
A.820	Encoder Checksum Error	The checksum results of encoder memory is incorrect.	Gr.1	N/A			
A.830	Absolute Encoder Battery Error	The battery voltage was lower than the specified value after the control power supply was turned ON.	Gr.1	Available	H	H	H
A.840	Encoder Data Error	Data in the encoder is incorrect.	Gr.1	N/A			
A.850	Encoder Overspeed	The encoder was rotating at high speed when the power was turned ON.	Gr.1	N/A			
A.860	Encoder Overheated	The internal temperature of encoder is too high.	Gr.1	N/A			
A.8A0	External Encoder Error	External encoder is faulty.	Gr.1	Available			
A.8A1	External Encoder Error of Module	Serial converter unit is faulty.	Gr.1	Available			
A.8A2	External Encoder Error of Sensor	External encoder is faulty.	Gr.1	Available			

(cont'd)

Alarm Number	Alarm Name	Meaning	Servo-motor Stopping Method	Alarm Reset	Alarm Code Output		
					ALO1	ALO2	ALO3
A.8A3	External Encoder Error of Position	The position data of external encoder is faulty.	Gr.1	Available			
A.8A5	External Encoder Overspeed	The overspeed from the external encoder occurred.	Gr.1	Available	H	H	H
A.8A6	External Encoder Overheated	The overheat from the external encoder occurred.	Gr.1	Available			
A.A□□*1	SERVOPACK: Command Option Module Alarms	–	–	–	–	–	–
A.b10	Speed Reference A/D Error	The A/D converter for speed reference input is faulty.	Gr.2	Available			
A.b11	Speed Reference A/D Data Error	A/D conversion data of speed reference input is incorrect.	Gr.2	Available			
A.b20	Reference Torque Input Read Error	The A/D converter for torque reference input is faulty.	Gr.2	Available			
A.b31	Current Detection Error 1	The current detection circuit for phase U is faulty.	Gr.1	N/A			
A.b32	Current Detection Error 2	The current detection circuit for phase V is faulty.	Gr.1	N/A			
A.b33	Current Detection Error 3	The detection circuit for the current is faulty.	Gr.1	N/A	H	H	H
A.bF0	System Alarm 0	"Internal program error 0" of the SERVO-PACK occurred.	Gr.1	N/A			
A.bF1	System Alarm 1	"Internal program error 1" of the SERVO-PACK occurred.	Gr.1	N/A			
A.bF2	System Alarm 2	"Internal program error 2" of the SERVO-PACK occurred.	Gr.1	N/A			
A.bF3	System Alarm 3	"Internal program error 3" of the SERVO-PACK occurred.	Gr.1	N/A			
A.bF4	System Alarm 4	"Internal program error 4" of the SERVO-PACK occurred.	Gr.1	N/A			
A.C10	Servo Overrun Detected	The servomotor ran out of control.	Gr.1	Available			
A.C80	Absolute Encoder Clear Error and Multiturn Limit Setting Error	The multiturn for the absolute encoder was not properly cleared or set.	Gr.1	N/A			
A.C90	Encoder Communications Error	Communications between the SERVO-PACK and the encoder is not possible.	Gr.1	N/A			
A.C91	Encoder Communications Position Data Error	An encoder position data calculation error occurred.	Gr.1	N/A			
A.C92	Encoder Communications Timer Error	An error occurs in the communications timer between the encoder and the SERVO-PACK.	Gr.1	N/A			
A.CA0	Encoder Parameter Error	Encoder parameters are faulty.	Gr.1	N/A	L	H	L
A.Cb0	Encoder Echoback Error	Contents of communications with encoder are incorrect.	Gr.1	N/A			
A.CC0	Multiturn Limit Disagreement	Different multiturn limits have been set in the encoder and the SERVO-PACK.	Gr.1	N/A			
A.CF1	Feedback Option Module Communications Error (Reception error)	Reception from the Feedback Option Module is faulty.	Gr.1	N/A			
A.CF2	Feedback Option Module Communications Error (Timer stop)	Timer for communications with the Feedback Option Module is faulty.	Gr.1	N/A			

(cont'd)

Alarm Number	Alarm Name	Meaning	Servo-motor Stopping Method	Alarm Reset	Alarm Code Output		
					ALO1	ALO2	ALO3
A.d00	Position Error Overflow	Position error exceeded the value of excessive position error alarm level (Pn520) when the servomotor power is ON.	Gr.1	Available	L	L	H
A.d01	Position Error Overflow Alarm at Servo ON	This alarm occurs if the servomotor power is turned ON when the position error is greater than the set value of Pn526 while the servomotor power is OFF.	Gr.1	Available			
A.d02	Position Error Overflow Alarm by Speed Limit at Servo ON	When the position errors remain in the error counter, Pn529 limits the speed if the servomotor power is turned ON. If Pn529 limits the speed in such a state, this alarm occurs when reference pulses are input and the number of position errors exceeds the value set for the excessive position error alarm level (Pn520).	Gr.2	Available			
A.d10	Motor-load Position Error Overflow	During fully-closed loop control, the position error between motor and load is excessive.	Gr.2	Available	H	L	L
A.E71	Safety Option Module Detection Failure	Detection of the safety option module failed.	Gr.1	N/A			
A.E72	Feedback Option Module Detection Failure	Detection of the Feedback Option Module failed.	Gr.1	N/A			
A.E74	Unsupported Safety Option Module	An unsupported safety option module was connected.	Gr.1	N/A			
A.E75	Unsupported Feedback Option Module	An unsupported feedback option module was connected.	Gr.1	N/A	-	-	-
A.E81^{*2}	SERVOPACK: Safety Module Alarm	-	-	-			
A.Eb1	Safety Function Signal Input Timing Error	The safety function signal input timing is faulty.	Gr.1	N/A			
A.Eb□^{*2}	SERVOPACK: Safety Module Alarms	-	-	-	-	-	-
A.EC□^{*2}	SERVOPACK: Safety Module Alarms	-	-	-			
A.F10	Main Circuit Cable Open Phase	With the main power supply ON, voltage was low for more than 1 second in phase R, S, or T.	Gr.2	Available	H	L	H
A.F50	Servomotor Main Circuit Cable Disconnection	The servomotor did not operate or power was not supplied to the servomotor even though the /S-ON (Servo ON) signal was input when the servomotor was ready to receive it.	Gr.1	Available			
FL-1^{*3}	System Alarm	Internal program error occurred in the SERVOPACK	-	N/A	Undefined		
FL-2^{*3}			-	N/A			
CPF00	Digital Operator Transmission Error 1	Digital operator (JUSP-OP05A-1-E) fails to communicate with the SERVOPACK (e.g., CPU error).	-	N/A	Undefined		
CPF01	Digital Operator Transmission Error 2		-	N/A			
A.--	Not an error	Normal operation status	-	-	H	H	H

- *1. These alarms occur in SERVOPACKs with command option modules.
For details, refer to the manual for the command option module that is connected.
- *2. These alarms occur in SERVOPACKs with safety modules.
For details, refer to *Σ-V Series User's Manual, Safety Module* (No.: SIEP C720829 06).
- *3. These alarms are not stored in the alarm history and are displayed only in the panel display.

10.1.2 Troubleshooting of Alarms

If an error occurs in servo drives, an alarm display such as A.□□□ and CPF□□ will appear on the panel operator.

Refer to the following table to identify the cause of an alarm and the action to be taken.

Contact your Yaskawa representative if the problem cannot be solved by the described corrective action.

Alarm Number: Alarm Name (Alarm Description)	Cause	Investigative Actions	Corrective Actions
A.020: Parameter Checksum Error 1 (The parameter data in the SERVOPACK is incorrect.)	The power supply voltage suddenly dropped.	Measure the power supply voltage.	Set the power supply voltage within the specified range, and set Fn005 to initialize the parameter.
	The power supply went OFF while changing a parameter setting.	Check the circumstances when the power supply went OFF.	Set Fn005 to initialize the parameter and then set the parameter again.
	The number of times that parameters were written exceeded the limit.	Check to see if the parameters were frequently changed through the host controller.	The SERVOPACK may be faulty. Replace the SERVOPACK. Reconsider the method of writing parameters.
	Malfunction caused by noise from the AC power supply or grounding line, static electricity noise, etc.	Turn the power supply ON and OFF several times. If the alarm still occurs, there may be noise interference.	Take countermeasures against noise.
	Gas, water drops, or cutting oil entered the SERVOPACK and caused failure of the internal components.	Check the installation conditions.	The SERVOPACK may be faulty. Replace the SERVOPACK.
	A SERVOPACK fault occurred.	Turn the power supply ON and OFF several times. If the alarm still occurs, the SERVOPACK may be faulty.	The SERVOPACK may be faulty. Replace the SERVOPACK.
A.021: Parameter Format Error 1 (The parameter data in the SERVOPACK is incorrect.)	The software version of SERVOPACK that caused the alarm is older than that of the written parameter.	Check Fn012 to see if the set software version agrees with that of the SERVOPACK. If not, an alarm may occur.	Write the parameter of another SERVOPACK of the same model with the same software version. Then turn the power OFF and then ON again.
	A SERVOPACK fault occurred.	–	The SERVOPACK may be faulty. Replace the SERVOPACK.
A.022: System Checksum Error 1 (The parameter data in the SERVOPACK is incorrect.)	The power supply voltage suddenly dropped.	Measure the power supply voltage.	The SERVOPACK may be faulty. Replace the SERVOPACK.
	The power supply went OFF while setting an utility function.	Check the circumstances when the power supply went OFF.	The SERVOPACK may be faulty. Replace the SERVOPACK.
	A SERVOPACK fault occurred.	Turn the power supply ON and OFF several times. If the alarm still occurs, the SERVOPACK may be faulty.	The SERVOPACK may be faulty. Replace the SERVOPACK.
A.030: Main Circuit Detector Error	A SERVOPACK fault occurred.	–	The SERVOPACK may be faulty. Replace the SERVOPACK.
A.040: Parameter Setting Error 1 (The parameter setting was out of the setting range.)	The SERVOPACK and servomotor capacities do not match each other.	Check the combination of SERVOPACK and servomotor capacities.	Select the proper combination of SERVOPACK and servomotor capacities.
	A SERVOPACK fault occurred.	–	The SERVOPACK may be faulty. Replace the SERVOPACK.
	The parameter setting is out of the setting range.	Check the setting ranges of the parameters that have been changed.	Set the parameter to a value within the setting range.
	The electronic gear ratio is out of the setting range.	Check the electronic gear ratio. The ratio must satisfy: $0.001 < (Pn20E/Pn210) < 4000$.	Set the electronic gear ratio in the range: $0.001 < (Pn20E/Pn210) < 4000$.

(cont'd)

Alarm Number: Alarm Name (Alarm Description)	Cause	Investigative Actions	Corrective Actions
A.041: Encoder Output Pulse Setting Error	The encoder output pulse (Pn212) is out of the setting range and does not satisfy the setting conditions.	Check the parameter Pn212.	Set Pn212 to a correct value.
A.042:*1 Parameter Combination Error	The speed of program JOG operation (Fn004) is lower than the setting range after having changed the electronic gear ratio (Pn20E/Pn210) or the servomotor.	Check if the detection conditions*1 are satisfied.	Decrease the setting of the electronic gear ratio (Pn20E/Pn210).
	The speed of program JOG operation (Fn004) is lower than the setting range after having changed the setting of the program JOG movement speed (Pn533).	Check if the detection conditions*1 are satisfied.	Increase the setting of the program JOG movement speed (Pn533).
	The moving speed of advanced autotuning is lower than the setting range after having changed the electronic gear ratio (Pn20E/Pn210) or the servomotor.	Check if the detection conditions*1 are satisfied.	Decrease the setting of the electronic gear ratio (Pn20E/Pn210).
A.044: Semi-closed/Fully- closed Loop Control Parameter Setting Error	The setting of the fully-closed module does not match with that of Pn002.3.	Check the settings of Pn002.3.	The setting of fully-closed module must be compatible with the setting of Pn002.3.
A.050: Combination Error (The SERVOPACK and servomotor capacities do not correspond.)	The SERVOPACK and servomotor capacities do not match each other.	Check the capacities to see if they satisfy the following condition: $\frac{1}{4} \leq \frac{\text{Servomotor capacity}}{\text{SERVOPACK capacity}} \leq 4$	Select the proper combination of SERVOPACK and servomotor capacities.
	An encoder fault occurred.	Replace the servomotor and see if the alarm occurs again.	Replace the servomotor (encoder).
	A SERVOPACK fault occurred.	–	The SERVOPACK may be faulty. Replace the SERVOPACK.
A.051: Unsupported Device Alarm	An unsupported serial converter unit, encoder, or external encoder is connected to the SERVOPACK.	Check the product specifications, and select the correct model.	Select the correct combination of units.
A.0b0: Cancelled Servo ON Command Alarm	After executing the utility function to turn ON the power to the motor, the servo ON signal (/S-ON) was sent from the host controller.	–	Turn the SERVOPACK power supply OFF and then ON again or execute a software reset.

*1. Detection conditions

If one of the following conditions detected, an alarm occurs.

- $\text{Pn533} [\text{min}^{-1}] \times \frac{\text{Encoder resolution}}{6 \times 10^5} \leq \frac{\text{Pn20E}}{\text{Pn210}}$
- $\text{Max Motor Speed} [\text{min}^{-1}] \times \frac{\text{Encoder resolution}}{\text{About } 3.66 \times 10^{12}} \geq \frac{\text{Pn20E}}{\text{Pn210}}$

(cont'd)

Alarm Number: Alarm Name (Alarm Description)	Cause	Investigative Actions	Corrective Actions
A.100: Overcurrent or Heat Sink Overheated (An overcurrent flowed through the IGBT or heat sink of SERVOPACK overheated.)	Incorrect wiring or contact fault of main circuit cables.	Check the wiring. Refer to <i>3.1 Main Circuit Wiring</i> .	Correct the wiring.
	Short-circuit or ground fault of main circuit cables.	Check for short-circuits across the servomotor terminal phases U, V, and W, or between the grounding and servomotor terminal phases U, V, or W. Refer to <i>3.1 Main Circuit Wiring</i> .	The cable may be short-circuited. Replace the cable.
	Short-circuit or ground fault inside the servomotor.	Check for short-circuits across the servomotor terminal phases U, V, and W, or between the grounding and servomotor terminal phases U, V, or W. Refer to <i>3.1 Main Circuit Wiring</i> .	The servomotor may be faulty. Replace the servomotor.
	Short-circuit or ground fault inside the SERVOPACK.	Check for short-circuits across the servomotor connection terminals U, V, and W on the SERVOPACK, or between the grounding and terminal U, V, or W. Refer to <i>3.1 Main Circuit Wiring</i> .	The SERVOPACK may be faulty. Replace the SERVOPACK.
	Incorrect wiring or contact fault of the regenerative resistor.	Check the wiring. Refer to <i>3.6 Connecting Regenerative Resistors</i> .	Correct the wiring.
	The dynamic brake (DB: Emergency stop executed from the SERVOPACK) was frequently activated, or the DB overload alarm occurred.	Check the power consumed by DB resistance (Un00B) to see how many times the DB has been used. Or, check the alarm history display Fn000 to see if the DB overload alarm A.730 or A.731 was reported.	Change the SERVOPACK model, operating conditions, or the mechanism so that the DB does not need to be used so frequently.
	The generated regenerative resistor value exceeded the SERVOPACK regenerative energy processing capacity.	Check the regenerative load ratio (Un00A) to see how many times the regenerative resistor has been used.	Check the operating condition including overload, and reconsider the regenerative resistor value.
	The SERVOPACK regenerative resistance is too small.	Check the regenerative load ratio (Un00A) to see how many times the regenerative resistor has been used.	Change the regenerative resistance value to a value larger than the SERVOPACK minimum allowable resistance value.
	A heavy load was applied while the servomotor was stopped or running at a low speed.	Check to see if the operating conditions are outside servo drive specifications.	Reduce the load applied to the servomotor or increase the operating speed.
	Malfunction caused by noise interference.	Improve the wiring or installation environment, such as by reducing noise, and check to see if the alarm recurs.	Take countermeasures for noise, such as correct wiring of the FG. Use an FG wire size equivalent to the SERVOPACK main circuit wire size.
A SERVOPACK fault occurred.	–	Turn the power supply OFF and then ON again. If the alarm still occurs, the SERVOPACK may be faulty. Replace the SERVOPACK.	

(cont'd)

Alarm Number: Alarm Name (Alarm Description)	Cause	Investigative Actions	Corrective Actions
A.300: Regeneration Error	<ul style="list-style-type: none"> Regenerative resistor capacity (Pn600) is set to a value other than 0 for a SGD V-R70, -R90, -1R6, -2R1, or -2R8 SERVO-PACK, and an external regenerative resistor is not connected. An external regenerative resistor is not connected to the SGD V-470, SGD V-550, SGD V-590, SGD V-780, SGD V-210, SGD V-260, SGD V-280, or SGD V-370 SERVOPACK. 	Check the external regenerative resistor connection and the value of the Pn600.	Connect the external regenerative resistor, or set Pn600 to 0 if no regenerative resistor is required.
	The jumper between the power supply terminals B2 and B3 is removed for the SERVOPACKs other than the SERVOPACKs shown above.	Confirm that a jumper is mounted between the power supply terminals B2 and B3.	Correctly mount a jumper.
	The external regenerative resistor is incorrectly wired, or is removed or disconnected.	Check the external regenerative resistor connection.	Correctly connect the external regenerative resistor.
	A SERVOPACK fault occurred.	–	While the main circuit power supply is OFF, turn the control power supply OFF and then ON again. If the alarm still occurs, the SERVO-PACK may be faulty. Replace the SERVOPACK.
A.320: Regenerative Overload	The power supply voltage exceeds the specified limit.	Measure the power supply voltage.	Set the power supply voltage within the specified range.
	Insufficient external regenerative resistance, regenerative resistor capacity, or SERVOPACK capacity. Or, regenerative power has been continuously flowing back.	Check the operating condition or the capacity using the capacity selection Software SigmaJunma-Size+, etc.	Change the regenerative resistance, regenerative resistor capacity, or SERVOPACK capacity. Reconsider the operating conditions using the capacity selection software SigmaJunmaSize+, etc.
	Regenerative power continuously flowed back because negative load was continuously applied.	Check the load applied to the servomotor during operation.	Reconsider the system including servo, machine, and operating conditions.
	The setting of parameter Pn600 is smaller than the external regenerative resistor's capacity.	Check the external regenerative resistor connection and the value of the Pn600.	Set the Pn600 to a correct value.
	The external regenerative resistance is too high.	Check the regenerative resistance.	Change the regenerative resistance to a correct value or use an external regenerative resistor of appropriate capacity.
	A SERVOPACK fault occurred.	–	The SERVOPACK may be faulty. Replace the SERVOPACK.

(cont'd)

Alarm Number: Alarm Name (Alarm Description)	Cause	Investigative Actions	Corrective Actions
A.330: Main Circuit Power Supply Wiring Error (Detected when the power to the main circuit is turned ON.)	The regenerative resistor disconnected when the SERVOPACK power supply voltage was high.	Measure the resistance of the regenerative resistor using a measuring instrument.	When using a regenerative resistor built in the SERVOPACK: Replace the SERVOPACK. When using an external regenerative resistor: Replace the external regenerative resistor.
	In the AC power input mode, DC power was supplied.	Check the power supply to see if it is a DC power supply.	Correct the settings to match the actual power supply specifications.
	In the DC power input mode, AC power was supplied.	Check the power supply to see if it is an AC power supply.	Correct the settings to match the actual power supply specifications.
	Regenerative resistor capacity (Pn600) is set to a value other than 0 for a SGDVR70, -R90, -1R6, -2R1, or -2R8 SERVOPACK, and an external regenerative resistor is not connected.	Check the external regenerative resistor connection and the value of the Pn600.	Connect the external regenerative resistor, or set Pn600 to 0 if no regenerative resistor is required.
	The jumper between the power supply terminals B2 and B3 is removed for the SERVOPACKs other than the SERVOPACKs shown above.	Confirm that a jumper is mounted between the power supply terminals B2 and B3.	Correctly mount a jumper.
	A SERVOPACK fault occurred.	–	The SERVOPACK may be faulty. Replace the SERVOPACK.
A.400: Overvoltage (Detected in the SERVOPACK main circuit power supply section.)	<ul style="list-style-type: none"> For 100-VAC SERVOPACKs: The AC power supply voltage exceeded 145 V. For 200-VAC SERVOPACKs: The AC power supply voltage exceeded 290 V. For 400-VAC SERVOPACKs: The AC power supply voltage exceeded 580 V. For 200-VAC SERVOPACKs: with DC power supply input: The DC power supply voltage exceeded 410 V. For 400-VAC SERVOPACKs: The DC power supply voltage exceeded 820 V. 	Measure the power supply voltage.	Set AC/DC power supply voltage within the specified range.
	The power supply is unstable, or was influenced by a lightning surge.	Measure the power supply voltage.	Improve the power supply conditions by installing a surge absorber, etc. Then, turn the power supply OFF and ON again. If the alarm still occurs, the SERVOPACK may be faulty. Replace the SERVOPACK.
	Voltage for AC power supply was too high during acceleration or deceleration.	Check the power supply voltage and the speed and torque during operation.	Set AC power supply voltage within the specified range.
	The external regenerative resistance is too high for the actual operating conditions.	Check the operating conditions and the regenerative resistance.	Select a regenerative resistance value appropriate for the operating conditions and load.
	The moment of inertia ratio exceeded the allowable value.	Confirm that the moment of inertia ratio is within the allowable range.	Increase the deceleration time, or reduce the load.
	A SERVOPACK fault occurred.	–	Turn the control power OFF and then ON again while the main circuit power supply is OFF. If the alarm still occurs, the SERVOPACK may be faulty. Replace the SERVOPACK.

(cont'd)

Alarm Number: Alarm Name (Alarm Description)	Cause	Investigative Actions	Corrective Actions
A.410: Undervoltage (Detected in the SERVOPACK main circuit power supply section.)	<ul style="list-style-type: none"> For 100-VAC SERVOPACKs: The AC power supply voltage is 49 V or less. For 200-VAC SERVOPACKs: The AC power supply voltage is 120 V or less. For 400-VAC SERVOPACKs: The AC power supply voltage is 240 V or less. 	Measure the power supply voltage.	Set the power supply voltage within the specified range.
	The power supply voltage dropped during operation.	Measure the power supply voltage.	Increase the power supply capacity.
	Occurrence of instantaneous power interruption.	Measure the power supply voltage.	When the instantaneous power cut hold time (Pn509) is set, decrease the setting.
	The SERVOPACK fuse is blown out.	—	Replace the SERVOPACK, connect a reactor, and run the SERVOPACK.
	A SERVOPACK fault occurred.	—	The SERVOPACK may be faulty. Replace the SERVOPACK.
A.450: Main-Circuit Capacitor Overvoltage	A SERVOPACK fault occurred.	—	Replace the SERVOPACK.
A.510: Overspeed (The servomotor speed exceeds the maximum.)	The order of phases U, V, and W in the servomotor wiring is incorrect.	Check the motor wiring.	Confirm that the servomotor is correctly wired.
	A reference value exceeding the overspeed detection level was input.	Check the input value.	Reduce the reference value or adjust the gain.
	The motor speed exceeded the maximum.	Check the motor speed waveform.	Reduce the speed reference input gain, adjust the servo gain, or reconsider the operating conditions.
	A SERVOPACK fault occurred.	—	The SERVOPACK may be faulty. Replace the SERVOPACK.
A.511: Overspeed of Encoder Output Pulse Rate	The encoder output pulse frequency exceeded the limit.	Check the encoder output pulse setting.	Decrease the setting of the encoder output pulse (Pn212).
	The encoder output pulse output frequency exceeded the limit because the motor speed was too high.	Check the encoder output pulse output setting and motor speed.	Decrease the motor speed.
A.520: Vibration Alarm	Abnormal vibration was detected at the motor speed.	Check for abnormal noise from the servomotor, and check the speed and torque waveforms during operation.	Reduce the motor speed or reduce the speed loop gain (Pn100).
	The moment of inertia ratio (Pn103) value is greater than the actual value or is greatly changed.	Check the moment of inertia ratio.	Set the moment of inertia ratio (Pn103) to an appropriate value.
A.521: Autotuning Alarm (Vibration was detected while executing the one-parameter tuning, EasyFFT, or tuning-less function.)	The servomotor vibrated considerably while performing tuning-less function.	Check the motor speed waveform.	Reduce the load so that the moment of inertia ratio falls within the allowable value, or raise the load level using the tuning-less levels setting (Fn200) or reduce the rigidity level.
	The servomotor vibrated considerably during one-parameter tuning or EasyFFT.	Check the motor speed waveform.	Check the operation procedure of corresponding function and take a corrective action.

(cont'd)

Alarm Number: Alarm Name (Alarm Description)	Cause	Investigative Actions	Corrective Actions
A.710: A.720: Overload A.710: High Load A.720: Low Load	Incorrect wiring or contact fault of servomotor and encoder.	Check the wiring.	Confirm that the servomotor and encoder are correctly wired.
	Operation beyond the overload protection characteristics.	Check the servomotor overload characteristics and executed run command.	Reconsider the load conditions and operating conditions. Or, increase the motor capacity.
	Excessive load was applied during operation because the servomotor was not driven due to mechanical problems.	Check the executed operation reference and motor speed.	Remove the mechanical problems.
	A SERVOPACK fault occurred.	–	The SERVOPACK may be faulty. Replace the SERVOPACK.
A.730: A.731: Dynamic Brake Overload (An excessive power consumption of dynamic brake was detected.)	The servomotor rotates because of external force.	Check the operation status.	Take measures to ensure the servomotor will not rotate because of external force.
	The rotating energy at a DB stop exceeds the DB resistance capacity.	Check the power consumed by DB resistance (Un00B) to see how many times the DB has been used.	Reconsider the following: <ul style="list-style-type: none"> • Reduce the motor reference speed. • Reduce the moment of inertia ratio. • Reduce the number of times of the DB stop operation.
	A SERVOPACK fault occurred.	–	The SERVOPACK may be faulty. Replace the SERVOPACK.
A.740: Overload of Surge Current Limit Resistor (The main circuit power is turned ON/OFF too frequently.)	The inrush current limit resistor operation frequency at the main circuit power supply ON/OFF operation exceeds the allowable range.	–	Reduce the frequency of turning the main circuit power supply ON/OFF.
	A SERVOPACK fault occurred.	–	The SERVOPACK may be faulty. Replace the SERVOPACK.
A.7A0: Heat Sink Overheated (Detected when the heat sink temperature exceeds 100°C.)	The surrounding air temperature is too high.	Check the surrounding air temperature using a thermostat.	Decrease the surrounding air temperature by improving the SERVOPACK installation conditions.
	The overload alarm has been reset by turning OFF the power too many times.	Check the alarm history display (Fn000) to see if the overload alarm was reported.	Change the method for resetting the alarm.
	Excessive load or operation beyond the regenerative energy processing capacity.	Check the accumulated load ratio (Un009) to see the load during operation, and the regenerative load ratio (Un00A) to see the regenerative energy processing capacity.	Reconsider the load and operating conditions.
	Incorrect SERVOPACK installation orientation or/and insufficient space around the SERVOPACK.	Check the SERVOPACK installation conditions.	Install the SERVOPACK correctly as specified.
	A SERVOPACK fault occurred.	–	The SERVOPACK may be faulty. Replace the SERVOPACK.
A.7AB: Built-in Fan in SERVOPACK Stopped	The fan inside the SERVOPACK stopped.	Check for foreign matter or debris inside the SERVOPACK.	Remove foreign matter or debris from the SERVOPACK. If the alarm still occurs, the SERVOPACK may be faulty. Replace the SERVOPACK.

(cont'd)

Alarm Number: Alarm Name (Alarm Description)	Cause	Investigative Actions	Corrective Actions
A.810: Encoder Backup Error (Only when an absolute encoder is connected.) (Detected on the encoder side.)	Alarm occurred when the power to the absolute encoder was initially turned ON.	Check to see if the power was turned ON initially.	Set up the encoder (Fn008).
	The encoder cable disconnected, and connected again.	Check to see if the power was turned ON initially.	Confirm the connection and set up the encoder (Fn008).
	The power from both the control power supply (+5 V) from the SERVOPACK and the battery power supply is not being supplied.	Check the encoder connector battery or the connector contact status.	Replace the battery or take similar measures to supply power to the encoder, and set up the encoder (Fn008).
	An absolute encoder fault occurred.	—	If the alarm cannot be reset by setting up the encoder again, replace the servomotor.
	A SERVOPACK fault occurred.	—	The SERVOPACK may be faulty. Replace the SERVOPACK.
A.820: Encoder Checksum Error (Detected on the encoder side.)	An encoder fault occurred.	—	<ul style="list-style-type: none"> Absolute encoder Set up the encoder again using Fn008. If the alarm still occurs, the servomotor may be faulty. Replace the servomotor. Absolute encoder that shows values for a single rotation or incremental encoder The servomotor may be faulty. Replace the servomotor.
	A SERVOPACK fault occurred.	—	The SERVOPACK may be faulty. Replace the SERVOPACK.
A.830: Absolute Encoder Battery Error (The absolute encoder battery voltage is lower than the specified value.)	The battery connection is incorrect.	Check the battery connection.	Reconnect the battery.
	The battery voltage is lower than the specified value 2.7 V.	Measure the battery voltage.	Replace the battery.
	A SERVOPACK fault occurred.	—	The SERVOPACK may be faulty. Replace the SERVOPACK.
A.840: Encoder Data Error (Detected on the encoder side.)	An encoder malfunctioned.	—	Turn the power supply OFF and then ON again. If the alarm still occurs, the servomotor may be faulty. Replace the servomotor.
	Malfunction of encoder because of noise interference, etc.	—	Correct the wiring around the encoder by separating the encoder cable from the servomotor main circuit cable or by checking the grounding and other wiring.
A.850: Encoder Overspeed (Detected when the control power supply was turned ON.) (Detected on the encoder side.)	The servomotor speed is higher than 200 min ⁻¹ when the control power supply was turned ON.	Check the motor rotating speed (Un000) to confirm the servomotor speed when the power is turned ON.	Reduce the servomotor speed to a value less than 200 min ⁻¹ , and turn ON the control power supply.
	An encoder fault occurred.	—	Turn the power supply OFF and then ON again. If the alarm still occurs, the servomotor may be faulty. Replace the servomotor.
	A SERVOPACK fault occurred.	—	Turn the power supply OFF and then ON again. If the alarm still occurs, the SERVOPACK may be faulty. Replace the SERVOPACK.

(cont'd)

Alarm Number: Alarm Name (Alarm Description)	Cause	Investigative Actions	Corrective Actions
A.860: Encoder Overheated (Only when an absolute encoder is connected.) (Detected on the encoder side.)	The ambient operating temperature around the servomotor is too high.	Measure the ambient operating temperature around the servomotor.	Reduce the ambient operating temperature of the servomotor to 40°C or less.
	The motor load is greater than the rated load.	Check the accumulated load ratio (Un009) to see the load.	Operate the SERVOPACK so that the motor load remains within the specified range.
	An encoder fault occurred.	—	Turn the power supply OFF and then ON again. If the alarm still occurs, the servomotor may be faulty. Replace the servomotor.
	A SERVOPACK fault occurred.	—	Turn the power supply OFF and then ON again. If the alarm still occurs, the SERVOPACK may be faulty. Replace the SERVOPACK.
A.8A0: External Encoder Error	Setting the zero point position of external absolute encoder failed because the servomotor rotated.	Before setting the zero point position, use the fully-closed feedback pulse counter (Un00E) to confirm that the servomotor is not rotating.	The servomotor must be stopped while setting the zero point position.
	An external encoder fault occurred.	—	Replace the external encoder.
A.8A1: External Encoder Error of Module	An external encoder fault occurred.	—	Replace the external encoder.
	A serial converter unit fault occurred.	—	Replace the serial converter unit.
A.8A2: External Encoder Error of Sensor (Incremental)	An external encoder fault occurred.	—	Replace the external encoder.
A.8A3: External Encoder Error of Position (Absolute)	An external absolute encoder fault occurred.	—	The external absolute encoder may be faulty. Refer to the encoder manufacturer's instruction manual for corrective actions.
A.8A5: External Encoder Overspeed	The overspeed from the external encoder occurred.	Check the maximum speed of the external encoder.	Keep the external encoder below its maximum speed.
A.8A6: External Encoder Overheated	The overheat from the external encoder occurred.	—	Replace the external encoder.
A.b10: Speed Reference A/D Error (Detected when the servo is ON.)	A malfunction occurred in the speed reference input section.	—	Clear and reset the alarm and restart the operation.
	A SERVOPACK fault occurred.	—	Turn the power supply OFF and then ON again. If the alarm still occurs, the SERVOPACK may be faulty. Replace the SERVOPACK.
A.b11: Speed Reference A/D Data Error	A malfunction occurred in the speed reference input section.	—	Clear and reset the alarm and restart the operation.
	A SERVOPACK fault occurred.	—	Turn the power supply OFF and then ON again. If the alarm still occurs, the SERVOPACK may be faulty. Replace the SERVOPACK.
A.b20: Reference Torque Input Read Error (Detected when the servo is ON.)	A malfunction occurred in the reading section of the torque reference input.	—	Clear and reset the alarm and restart the operation.
	A SERVOPACK fault occurred.	—	Turn the power supply OFF and then ON again. If the alarm still occurs, the SERVOPACK may be faulty. Replace the SERVOPACK.

(cont'd)

Alarm Number: Alarm Name (Alarm Description)	Cause	Investigative Actions	Corrective Actions
A.b31: Current Detection Error 1	The current detection circuit for phase U is faulty.	—	Turn the power supply OFF and then ON again. If the alarm still occurs, the SERVOPACK may be faulty. Replace the SERVOPACK.
A.b32: Current Detection Error 2	The current detection circuit for phase V is faulty.	—	Turn the power supply OFF and then ON again. If the alarm still occurs, the SERVOPACK may be faulty. Replace the SERVOPACK.
A.b33: Current Detection Error 3	The detection circuit for the current is faulty.	—	Turn the power supply OFF and then ON again. If the alarm still occurs, the SERVOPACK may be faulty. Replace the SERVOPACK.
	The servomotor main circuit cable is disconnected.	Check for disconnection of the servomotor main circuit cable.	Correct the servomotor wiring.
A.bF0: System Alarm 0	A SERVOPACK fault occurred.	—	Turn the power supply OFF and then ON again. If the alarm still occurs, the SERVOPACK may be faulty. Replace the SERVOPACK.
A.bF1: System Alarm 1	A SERVOPACK fault occurred.	—	Turn the power supply OFF and then ON again. If the alarm still occurs, the SERVOPACK may be faulty. Replace the SERVOPACK.
A.bF2: System Alarm 2	A SERVOPACK fault occurred.	—	Turn the power supply OFF and then ON again. If the alarm still occurs, the SERVOPACK may be faulty. Replace the SERVOPACK.
A.bF3: System Alarm 3	A SERVOPACK fault occurred.	—	Turn the power supply OFF and then ON again. If the alarm still occurs, the SERVOPACK may be faulty. Replace the SERVOPACK.
A.bF4: System Alarm 4	A SERVOPACK fault occurred.	—	Turn the power supply OFF and then ON again. If the alarm still occurs, the SERVOPACK may be faulty. Replace the SERVOPACK.
A.C10: Servo Overrun Detected (Detected when the servomotor power is ON.)	The order of phases U, V, and W in the servomotor wiring is incorrect.	Check the motor wiring.	Confirm that the servomotor is correctly wired.
	An encoder fault occurred.	—	If the alarm still occurs after turning the power OFF and then ON again, even though the servomotor is correctly wired, the servomotor may be faulty. Replace the servomotor.
	A SERVOPACK fault occurred.	—	Turn the power supply OFF and then ON again. If the alarm still occurs, the SERVOPACK may be faulty. Replace the SERVOPACK.
A.C80: Absolute Encoder Clear Error and Multi-turn Limit Setting Error	An encoder fault occurred.	—	Turn the power supply OFF and then ON again. If the alarm still occurs, the servomotor may be faulty. Replace the servomotor.
	A SERVOPACK fault occurred.	—	Turn the power supply OFF and then ON again. If the alarm still occurs, the SERVOPACK may be faulty. Replace the SERVOPACK.

(cont'd)

Alarm Number: Alarm Name (Alarm Description)	Cause	Investigative Actions	Corrective Actions
A.C90: Encoder Communica- tions Error	Contact fault of connector or incorrect wiring for encoder cable.	Check the connector contact status for encoder cable.	Re-insert the connector and confirm that the encoder is correctly wired.
	Cable disconnection for encoder cable or short-circuit. Or, incorrect cable impedance.	Check the encoder cable.	Use the cable with the specified rating.
	Corrosion caused by improper temperature, humidity, or gas, short-circuit caused by intrusion of water drops or cutting oil, or connector contact fault caused by vibration.	Check the operating environment.	Improve the operating environmental conditions, and replace the cable. If the alarm still occurs, replace the SERVOPACK.
	Malfunction caused by noise interference.	—	Correct the wiring around the encoder by separating the encoder cable from the servomotor main circuit cable or by checking the grounding and other wiring.
	A SERVOPACK fault occurred.	—	Connect the servomotor to another SERVOPACK, and turn ON the control power. If no alarm occurs, the SERVOPACK may be faulty. Replace the SERVOPACK.
A.C91: Encoder Communica- tions Position Data Er- ror	Noise interference occurred on the I/O signal line because the encoder cable is bent and the sheath is damaged.	Check the encoder cable and connector.	Confirm that there is no problem with the cable layout.
	The encoder cable is bundled with a high-current line or near a high-current line.	Check the cable layout for encoder cable.	Confirm that there is no surge voltage on the cable.
	The FG potential varies because of influence from machines on the servomotor side, such as the welder.	Check the cable layout for encoder cable.	Properly ground the machines to separate from the encoder FG.
A.C92: Encoder Communica- tions Timer Error	Noise interference occurred on the I/O signal line from the encoder.	—	Take countermeasures against noise for the encoder wiring.
	Excessive vibration and shocks were applied to the encoder.	Check the operating environment.	Reduce the machine vibration or correctly install the servomotor.
	An encoder fault occurred.	—	Turn the power supply OFF and then ON again. If the alarm still occurs, the servomotor may be faulty. Replace the servomotor.
	A SERVOPACK fault occurred.	—	Turn the power supply OFF and then ON again. If the alarm still occurs, the SERVOPACK may be faulty. Replace the SERVOPACK.
A.CA0: Encoder Parameter Error	An encoder fault occurred.	—	Turn the power supply OFF and then ON again. If the alarm still occurs, the servomotor may be faulty. Replace the servomotor.
	A SERVOPACK fault occurred.	—	Turn the power supply OFF and then ON again. If the alarm still occurs, the SERVOPACK may be faulty. Replace the SERVOPACK.

(cont'd)

Alarm Number: Alarm Name (Alarm Description)	Cause	Investigative Actions	Corrective Actions
A.Cb0: Encoder Echoback Error	The wiring and contact for encoder cable are incorrect.	Check the wiring.	Correct the wiring.
	Noise interference occurred due to incorrect cable specifications of encoder cable.	–	Use tinned annealed copper shielded twisted-pair or screened unshielded twisted-pair cable with a core of at least 0.12 mm ² .
	Noise interference occurred because the wiring distance for the encoder cable is too long.	–	The wiring distance must be 50 m max.
	The FG potential varies because of influence from machines on the servomotor side, such as the welder.	Check the cable layout for encoder cable.	Properly ground the machines to separate from encoder FG.
	Excessive vibration and shocks were applied to the encoder.	Check the operating environment.	Reduce the machine vibration or correctly install the servomotor.
	An encoder fault occurred.	–	Turn the power supply OFF and then ON again. If the alarm still occurs, the servomotor may be faulty. Replace the servomotor.
	A SERVOPACK fault occurred.	–	Turn the power supply OFF and then ON again. If the alarm still occurs, the SERVOPACK may be faulty. Replace the SERVOPACK.
A.CC0: Multiturn Limit Disagreement	When using a direct drive (DD) servomotor, the multiturn limit value (Pn205) is different from that of the encoder.	Check the value of the Pn205.	Correct the setting of Pn205 (0 to 65535).
	The multiturn limit value of the encoder is different from that of the SERVOPACK. Or, the multiturn limit value of the SERVOPACK has been changed.	Check the value of the Pn205 of the SERVOPACK.	Execute Fn013 at the occurrence of alarm.
	A SERVOPACK fault occurred.	–	Turn the power supply OFF and then ON again. If the alarm still occurs, the SERVOPACK may be faulty. Replace the SERVOPACK.
A.CF1: Feedback Option Module Communications Error (Reception error)	Wiring of cable between serial converter unit and SERVOPACK is incorrect or contact is faulty.	Check the external encoder wiring.	Correct the cable wiring.
	The specified cable is not used between serial converter unit and SERVOPACK.	Confirm the external encoder wiring specifications.	Use the specified cable.
	Cable between serial converter unit and SERVOPACK is too long.	Measure the length of this cable.	Use 20-m cable max.
	Sheath of cable between serial converter unit and SERVOPACK is broken.	Check the cable for damage.	Replace the cable.
A.CF2: Feedback Option Module Communications Error (Timer stop)	Noise interferes with the cable between serial converter unit and SERVOPACK.	–	Correct the wiring around serial converter unit, e.g., separating I/O signal line from main circuit cable or grounding.
	A serial converter unit fault occurred.	–	Replace the serial converter unit.
	A SERVOPACK fault occurred.	–	Replace the SERVOPACK.

(cont'd)

Alarm Number: Alarm Name (Alarm Description)	Cause	Investigative Actions	Corrective Actions
A.d00: Position Error Overflow (Position error exceeded the value set in the excessive position error alarm level (Pn520).)	The servomotor U, V, and W wirings is faulty.	Check the servomotor main circuit cable connection.	Confirm that there is no contact fault in the motor wiring or encoder wiring.
	The frequency of the position reference pulse is too high.	Reduce the reference pulse frequency, and operate the SERVOPACK.	Reduce the position reference pulse frequency or acceleration of position reference. Or, reconsider the electronic gear ratio.
	The acceleration of the position reference is too high.	Reduce the reference acceleration, and operate the SERVOPACK.	Apply the smoothing function, such as using position reference acceleration/deceleration time constant (Pn216).
	Setting of the excessive position error alarm level (Pn520) is low against the operating condition.	Check the alarm level (Pn520) to see if it is set to an appropriate value.	Set the Pn520 to proper value.
	A SERVOPACK fault occurred.	—	Turn the power supply OFF and then ON again. If the alarm still occurs, the SERVOPACK may be faulty. Replace the SERVOPACK.
A.d01: Position Error Overflow Alarm at Servo ON	This alarm occurs if the servomotor power is turned ON when the position error is greater than the set value of Pn526 while the servomotor power is OFF.	Check the position error amount (Un008) while the servomotor power is OFF.	Set position error to be cleared while the servomotor power is OFF. Or, correct the excessive position error alarm level at servo ON (Pn526).
A.d02: Position Error Overflow Alarm by Speed Limit at Servo ON	When the position errors remain in the error counter, Pn529 limits the speed if the servomotor power is ON. If Pn529 limits the speed in such a state, this alarm occurs when reference pulses are input and the number of position errors exceeds the value set for the excessive position error alarm level (Pn520).	—	Set position error to be cleared while the servomotor power is OFF. Or, correct the excessive position error alarm level (Pn520). Or, adjust the speed limit level at servo ON (Pn529).
A.d10: Motor-load Position Error Overflow	Motor rotation direction and external encoder installation direction are opposite.	Check the servomotor rotation direction and the external encoder installation direction.	Install the external encoder in the opposite direction, or change the setting of the external encoder usage method (Pn002.3) to reverse the direction.
	Mounting of the load (e.g., stage) and external encoder joint installation are incorrect.	Check the external encoder mechanical connection.	Check the mechanical joints.
A.E71: Safety Option Module Detection Failure	The connection between the SERVOPACK and the safety option module is faulty.	Check the connection between the SERVOPACK and the safety option module.	Correctly connect the safety option module.
	The safety option module was disconnected.	—	Execute Fn014 (Resetting configuration error of option module) with using the digital operator or SigmaWin+ and turn the power supply OFF and then ON again.
	A safety option module fault occurred.	—	Replace the safety option module.
	A SERVOPACK fault occurred.	—	Replace the SERVOPACK.

(cont'd)

Alarm Number: Alarm Name (Alarm Description)	Cause	Investigative Actions	Corrective Actions
A.E72: Feedback Option Module Detection Failure	The connection between the SERVOPACK and the Feedback Option Module is Faulty.	Check the connection between the SERVOPACK and the Feedback Option Module.	Correctly connect the Feedback Option Module.
	The Feedback Option Module was disconnected.	–	Execute resetting configuration error in option modules (Fn014) and turn the power supply OFF and then ON again.
	A Feedback Option Module fault occurred.	–	Replace the Feedback Option Module.
	A SERVOPACK fault occurred.	–	Replace the SERVOPACK.
A.E74: Unsupported Safety Option Module	A safety option module fault occurred.	–	Replace the safety option module.
	A unsupported safety option module was connected.	Refer to the catalog of the connected safety option module.	Connect a compatible safety option module.
A.E75: Unsupported Feed- back Option Module	A feedback option module fault occurred.	–	Replace the feedback option module.
	A unsupported feedback option module was connected.	Refer to the catalog of the connected feedback option module or the manual of the SERVOPACK.	Connect a compatible feedback option module.
A.Eb1: Safety Function Signal Input Timing Error	The lag between activations of the input signals /HWBB1 and /HWBB2 for the HWBB function is ten second or more.	Measure the time lag between the /HWBB1 and /HWBB2 signals.	The output signal circuits or devices for /HWBB1 and /HWBB2 or the SERVOPACK input signal circuits may be faulty. Alternatively, the input signal cables may be disconnected. Check if any of these items are faulty or have been disconnected.
A.F10: Main Circuit Cable Open Phase (With the main power supply ON, voltage was low for more than 1 second in an R, S, or T phase.) (Detected when the main power supply was turned ON.)	The three-phase power supply wiring is incorrect.	Check the power supply wiring.	Confirm that the power supply is correctly wired.
	The three-phase power supply is unbalanced.	Measure the voltage at each phase of the three-phase power supply.	Balance the power supply by changing phases.
	A single-phase power is input without setting Pn00B.2 (power supply method for three-phase SERVOPACK) to 1 (single-phase power supply).	Check the power supply and the parameter setting.	Match the parameter setting to the power supply.
	A SERVOPACK fault occurred.	–	Turn the power supply OFF and then ON again. If the alarm still occurs, the SERVOPACK may be faulty. Replace the SERVOPACK.
A.F50: Servomotor Main Circuit Cable Disconnection (The servomotor did not operate or power was not supplied to the servomotor even though the /S-ON (Servo ON) signal was input when the servomotor was ready to receive it.)	A SERVOPACK fault occurred.	–	The SERVOPACK may be faulty. Replace the SERVOPACK.
	The wiring is not correct or there is a faulty contact in the motor wiring.	Check the wiring.	Make sure that the servomotor is correctly wired.
FL-1*2: System Alarm	SERVOPACK failure	–	Turn the power supply OFF and then ON again. If the alarm still occurs, the SERVOPACK may be faulty. Replace the SERVOPACK.
FL-2*2: System Alarm		–	

(cont'd)

Alarm Number: Alarm Name (Alarm Description)	Cause	Investigative Actions	Corrective Actions
CPF00: Digital Operator Transmission Error 1	The contact between the digital operator and the SERVOPACK is faulty.	Check the connector contact.	Insert securely the connector or replace the cable.
	Malfunction caused by noise interference.	–	Keep the digital operator or the cable away from noise sources.
CPF01: Digital Operator Transmission Error 2	A digital operator fault occurred.	–	Disconnect the digital operator and then re-connect it. If the alarm still occurs, the digital operator may be faulty. Replace the digital operator.
	A SERVOPACK fault occurred.	–	Turn the power supply OFF and then ON again. If the alarm still occurs, the SERVOPACK may be faulty. Replace the SERVOPACK.

*2. These alarms are not stored in the alarm history and are displayed only in the panel display.

10.2 Warning Displays

The following sections describe troubleshooting in response to warning displays.

The warning name, warning meaning, and warning code output are listed in order of the warning numbers in *10.2.1 List of Warnings*.

The causes of warnings and troubleshooting methods are provided in *10.2.2 Troubleshooting of Warnings*.

10.2.1 List of Warnings

This section provides list of warnings.

Warning Number	Warning Name	Meaning	Warning Code Output		
			ALO1	ALO2	ALO3
A.900	Position Error Overflow	Position error exceeded the parameter setting (Pn520×Pn51E/100).	H	H	H
A.901	Position Error Overflow Alarm at Servo ON	When the servomotor power is ON, the position error exceeded the parameter setting (Pn526×Pn528/100).	H	H	H
A.910	Overload	This warning occurs before the overload alarms (A.710 or A.720) occur. If the warning is ignored and operation continues, an overload alarm may occur.	L	H	H
A.911	Vibration	Abnormal vibration at the motor speed was detected. The detection level is the same as A.520. Set whether to output an alarm or warning by the vibration detection switch (Pn310).	L	H	H
A.920	Regenerative Overload	This warning occurs before the regenerative overload alarm (A.320) occurs. If the warning is ignored and operation continues, a regenerative overload alarm may occur.	H	L	H
A.921	Dynamic Brake Overload	This warning occurs before dynamic brake overload alarm (A.731) occurs. If the warning is ignored and operation continues, a dynamic brake overload alarm may occur.	H	L	H
A.930	Absolute Encoder Battery Error	This warning occurs when the voltage of absolute encoder's battery is lowered.	L	L	H
A.941	Change of Parameters Requires Restart	Parameters that require the restart have been changed.	H	H	L
A.971	Undervoltage	This warning occurs before undervoltage alarm (A.410) occurs. If the warning is ignored and operation continues, an undervoltage alarm may occur.	L	L	L
A.9A0	Overtravel	Overtravel is detected while the servomotor power is ON.	H	L	L

Note 1. Warning code is not output without setting Pn001.3 = 1 (outputs both alarm codes and warning codes).

2. If Pn008.2 = 1 (does not detect warning) is selected, no warnings will be detected except for an undervoltage warning (A.971).

10.2.2 Troubleshooting of Warnings

Refer to the following table to identify the cause of a warning and the action to be taken. Contact your Yaskawa representative if the problem cannot be solved by the described corrective action.

Warning Number: Warning Name (Warning Description)	Cause	Investigative Actions	Corrective Actions
A.900: Position Error Overflow	The servomotor U, V, and W wirings is faulty.	Check the servomotor main circuit cable connection.	Confirm that there is no contact fault in the motor wiring or encoder wiring.
	The SERVOPACK gain is too low.	Check the SERVOPACK gain.	Increase the servo gain by using the function such as advanced autotuning.
	The frequency of the position reference pulse is too high.	Reduce the reference pulse frequency, and operate the SERVOPACK.	Reduce the position reference pulse frequency or acceleration of position reference. Or, reconsider the electronic gear ratio.
	The acceleration of the position reference is too high.	Reduce the reference acceleration, and operate the SERVOPACK.	Apply the smoothing function, such as using the position reference acceleration/deceleration time constant (Pn216).
	Setting of the excessive position error alarm level (Pn520) is low against the operating condition.	Check the alarm level (Pn520) to see if it is set to an appropriate value.	Set the Pn520 to proper value.
	A SERVOPACK fault occurred.	—	Turn the power supply OFF and then ON again. If the alarm still occurs, the SERVOPACK may be faulty. Replace the SERVOPACK.
A.901: Position Error Overflow Alarm at Servo ON	When the servomotor power is ON, the position error exceeded the parameter setting (Pn526×Pn528/100).	—	Set Pn200.2 to 0 to clear the number of position error while the servomotor power is OFF. Or set an appropriate value for the excessive position error warning level at servo ON (Pn528).
A.910: Overload (Warning before alarm A.710 or A.720 occurs)	Incorrect wiring or contact fault of servomotor and encoder.	Check the wiring.	Confirm that the servomotor and encoder are correctly wired.
	Operation beyond the overload protection characteristics.	Check the motor overload characteristics and executed run command.	Reconsider the load conditions and operating conditions. Or, increase the motor capacity.
	Excessive load was applied during operation because the servomotor was not driven due to mechanical problems.	Check the executed operation reference and motor speed.	Remove the mechanical problems.
	A SERVOPACK fault occurred.	—	The SERVOPACK may be faulty. Replace the SERVOPACK.

(cont'd)

Warning Number: Warning Name (Warning Description)	Cause	Investigative Actions	Corrective Actions
A.911: Vibration	Abnormal vibration was detected at the motor speed.	Check for abnormal noise from the servomotor, and check the speed and torque waveforms during operation.	Reduce the motor speed or reduce the servo gain by using the function such as one-parameter tuning.
	The moment of inertia ratio (Pn103) value is greater than the actual value or is greatly changed.	Check the moment of inertia ratio.	Set the moment of inertia ratio (Pn103) to an appropriate value.
A.920: Regenerative Overload (Warning before the alarm A.320 occurs)	The power supply voltage exceeds the specified limit.	Measure the power supply voltage.	Set the power supply voltage within the specified range.
	Insufficient external regenerative resistance, regenerative resistor capacity, or SERVOPACK capacity. Or, regenerative power has been continuously flowing back.	Check the operating condition or the capacity using the capacity selection Software SigmaJunmaSize+, etc.	Change the regenerative resistance, regenerative resistor capacity, or SERVOPACK capacity. Reconsider the operating conditions using the capacity selection software SigmaJunmaSize+, etc.
	Regenerative power continuously flowed back because negative load was continuously applied.	Check the load to the servomotor during operation.	Reconsider the system including servo drives, machine, and operating conditions.
A.921: Dynamic Brake Overload (Warning before the alarm A.731 occurs)	The servomotor rotates because of external force.	Check the operation status.	Take measures to ensure the servomotor will not rotate because of external force.
	The rotating energy at a DB stop exceeds the DB resistance capacity.	Check the power consumed by DB resistance (Un00B) to see how many times the DB has been used.	Reconsider the following: <ul style="list-style-type: none"> • Reduce the motor reference speed. • Reduce the moment of inertia ratio. • Reduce the number of times of the DB stop operation.
	A SERVOPACK fault occurred.	–	The SERVOPACK may be faulty. Replace the SERVOPACK.
A.930: Absolute Encoder Battery Error (The absolute encoder battery voltage is lower than the specified value.) * Only when an absolute encoder is connected.	The battery connection is incorrect.	Check the battery connection.	Reconnect the battery.
	The battery voltage is lower than the specified value 2.7 V.	Measure the battery voltage.	Replace the battery.
	A SERVOPACK fault occurred.	–	The SERVOPACK may be faulty. Replace the SERVOPACK.
A.941: Change of Parameters Requires Restart	Parameters that require the restart have been changed.	–	Turn OFF the power and ON again.

(cont'd)

Warning Number: Warning Name (Warning Description)	Cause	Investigative Actions	Corrective Actions
A.971: Under-voltage	<ul style="list-style-type: none"> • For 100 VAC SERVOPACKs: The AC power supply voltage is 60 V or less. • For 200-VAC SERVOPACKs: The AC power supply voltage is 140 V or less. • For 400-VAC SERVOPACKs: The AC power supply voltage is 280 V or less. 	Measure the power supply voltage.	Set the power supply voltage within the specified range.
	The power supply voltage dropped during operation.	Measure the power supply voltage.	Increase the power supply capacity.
	Occurrence of instantaneous power interruption.	Measure the power supply voltage.	When the instantaneous power cut hold time (Pn509) is set, decrease the setting.
	The SERVOPACK fuse is blown out.	—	Replace the SERVOPACK and connect a reactor to the SERVOPACK.
	A SERVOPACK fault occurred.	—	The SERVOPACK may be faulty. Replace the SERVOPACK.
A.9A0: Overtravel (Overtravel status is detected.)	When the servomotor power is ON, overtravel status is detected.	Check the input signal monitor (Un005) to check the status of the overtravel signals.	<p>Refer to <i>10.3 Troubleshooting Malfunction Based on Operation and Conditions of the Servomotor</i>. Even if overtravel signals were not shown by the input signal monitor (Un005), momentary overtravel may have been detected. Take the following precautions.</p> <ul style="list-style-type: none"> • Do not specify movements that would cause overtravel from the host controller. • Check the wiring of the overtravel signals. • Take countermeasures for noise.

10.3 Troubleshooting Malfunction Based on Operation and Conditions of the Servomotor

Troubleshooting for the malfunctions based on the operation and conditions of the servomotor is provided in this section.

Be sure to turn OFF the servo system before troubleshooting items shown in bold lines in the table.

Problem	Probable Cause	Investigative Actions	Corrective Actions
Servomotor Does Not Start	The control power supply is not ON.	Check voltage between control power terminals.	Correct the wiring.
	The main circuit power supply is not ON.	Check the voltage between main circuit power terminals.	Correct the wiring.
	Wiring of I/O signal connector CN1 is faulty or disconnected.	Check if the connector CN1 is properly inserted and connected.	Correct the connector CN1 connection.
	Wiring for servomotor main circuit cable or encoder cable is disconnected.	Check the wiring.	Correct the wiring.
	Overloaded	Run under no load and check the load status.	Reduce load or replace with larger capacity servomotor.
	Encoder type differs from parameter setting (Pn002.2).	Check the settings for parameter Pn002.2.	Set parameter Pn002.2 to the encoder type being used.
	Speed/position references not input	Check the allocation status of the input signals.	Allocate input signals so that the speed/position reference is input correctly.
	Settings for the input signal selections (Pn50A to Pn50D) is incorrect.	Check the settings for parameters Pn50A to Pn50D.	Correct the settings for parameter Pn50A to Pn50D.
	Servo ON signal (/S-ON) stays OFF.	Check the settings for parameters Pn50A.0 and Pn50A.1.	Set the parameters Pn50A.0 and Pn50A.1 to turn the /S-ON signal ON.
	/P-CON input function setting is incorrect.	Check the settings for parameter Pn000.1.	Set parameters to match the application.
	SEN input is OFF.	Check the ON/OFF status of the SEN input.	If using an absolute encoder, turn the SEN input signal ON.
	Reference pulse mode selection is incorrect.	Check the Pn200.0 setting and the reference pulse form.	Match the Pn200.0 setting and the reference pulse form.
	Speed control: Speed reference input is incorrect.	Check V-REF and SG to confirm if the control method and the input are agreed.	Correct the control method selection parameter, and the input signal.
	Torque control: Torque reference input is incorrect.	Check V-REF and SG to confirm if the control method and the input are agreed.	Correct the control method selection parameter, and the input signal.
	Position control: Reference pulse input is incorrect.	Check Pn200.0 reference pulse form and sign + pulse signal.	Correct the control method selection parameter, and the input signal.
	Position error clear (/CLR) input has not been turned OFF.	Check /CLR input signals (CN1-14 and -15).	Turn /CLR input signals OFF.
	The forward run prohibited (P-OT) and reverse run prohibited (N-OT) input signals are turned OFF.	Check P-OT or N-OT input signal.	Turn P-OT or N-OT input signal ON.
	The safety input signal (/HWBB1 or /HWBB2) remains OFF.	Check the /HWBB1 and /HWBB2 input signal.	Set the /HWBB1 and /HWBB2 input signal to ON. When not using the safety function, mount the safety function's jumper connector (provided as an accessory) on the CN8.
A SERVOPACK fault occurred.	—	Replace the SERVOPACK.	

(cont'd)

Problem	Probable Cause	Investigative Actions	Corrective Actions
Servomotor Moves Instantaneously, and then Stops	Servomotor wiring is incorrect.	Check the wiring.	Correct the wiring.
	Encoder wiring is incorrect.	Check the wiring.	Correct the wiring.
Servomotor Speed Unstable	Wiring connection to servomotor is defective.	Check connections of power line (phases U, V, and W) and encoder connectors.	Tighten any loose terminals or connectors and correct the wiring.
Servomotor Rotates Without Reference Input	Speed control: Speed reference input is incorrect.	Check V-REF and SG to confirm if the control method and the input are agreed.	Correct the control method selection parameter, and the input signal.
	Torque control: Torque reference input is incorrect.	Check V-REF and SG to confirm if the control method and the input are agreed.	Correct the control method selection parameter, and the input signal.
	Speed reference offset is incorrect.	The SERVOPACK offset is adjusted incorrectly.	Adjust the SERVOPACK offset.
	Position control: Reference pulse input is incorrect.	Check the reference pulse form (Pn200.0) and sign + pulse signal.	Correct the control method selection parameter, and the input signal.
	A SERVOPACK fault occurred.	–	Replace the SERVOPACK.
Dynamic Brake Does Not Operate	Improper Pn001.0 setting	Check the setting for parameter Pn001.0.	Correct the setting for parameter Pn001.0.
	DB resistor disconnected	Check if excessive moment of inertia, motor overspeed, or DB frequently activated occurred.	Replace the SERVOPACK, and reduce the load.
	DB drive circuit fault	–	There is a defective component in the DB circuit. Replace the SERVOPACK.
Abnormal Noise from Servomotor	The servomotor largely vibrated during execution of tuning-less function.	Check the motor speed waveform.	Reduce the load so that the moment of inertia ratio becomes within the allowable value, or increase the load level or lower the tuning level for the tuning-less levels setting (Fn200).
	Mounting is not secured.	Check if there are any loose mounting screws.	Tighten the mounting screws.
		Check if there is misalignment of couplings.	Align the couplings.
		Check if there are unbalanced couplings.	Balance the couplings.
	Bearings are defective.	Check for noise and vibration around the bearings.	Replace the servomotor.
	Vibration source at the driven machine.	Check for any foreign matter, damage, or deformations on the machinery's movable parts.	Contact the machine manufacturer.
	Noise interference due to incorrect I/O signal cable specifications.	The I/O signal cable must be tinned annealed copper shielded twisted-pair or screened unshielded twisted-pair cable with a core of 0.12 mm ² min.	Use the specified I/O signal cable.
	Noise interference due to length of I/O signal cable.	Check the length of the I/O signal cable.	The I/O signal cable length must be no more than 3 m.
	Noise interference due to incorrect cable specifications of encoder cable.	The encoder cable must be tinned annealed copper shielded twisted-pair or screened unshielded twisted-pair cable with a core of 0.12 mm ² min.	Use the specified encoder cable.
Noise interference due to length of encoder cable.	Check the length of the encoder cable.	The encoder cable must be no more than 50 m.	

(cont'd)

Problem	Probable Cause	Investigative Actions	Corrective Actions
Abnormal Noise from Servomotor (cont'd)	Noise interference due to damaged encoder cable.	Check if the encoder cable is bent and the sheath is damaged.	Replace the encoder cable and correct the cable layout.
	Excessive noise to the encoder cable.	Check if the encoder cable is bundled with a high-current line or near a high-current line.	Correct the cable layout so that no surge is applied.
	The FG potential varies because of influence from machines on the servomotor side, such as the welder.	Check if the machines are correctly grounded.	Properly ground the machines to separate from the encoder FG.
	SERVOPACK pulse counting error due to noise interference	Check if there is noise interference on the I/O signal line from the encoder.	Take measures against noise in the encoder wiring.
	Excessive vibration and shock to the encoder	Check if vibration from the machine occurred or servomotor installation is incorrect (mounting surface accuracy, fixing, alignment, etc.).	Reduce vibration from the machine, or secure the servomotor installation.
	An encoder fault occurred.	—	Replace the servomotor.
Servomotor Vibrates at Frequency of Approx. 200 to 400 Hz.	Unbalanced servo gains	Check to see if the servo gains have been correctly adjusted.	Execute the advanced autotuning.
	Speed loop gain value (Pn100) too high.	Check the speed loop gain (Pn100). Factory setting: $K_v = 40.0$ Hz	Reduce the speed loop gain (Pn100).
	Position loop gain value (Pn102) too high.	Check the position loop gain (Pn102). Factory setting: $K_p = 40.0/s$	Reduce the position loop gain (Pn102).
	Incorrect speed loop integral time constant (Pn101)	Check the speed loop integral time constant (Pn101). Factory setting: $T_i = 20.0$ ms	Correct the speed loop integral time constant (Pn101).
	Incorrect moment of inertia ratio (Pn103)	Check the moment of inertia ratio (Pn103).	Correct the moment of inertia ratio (Pn103).
High Motor Speed Overshoot on Starting and Stopping	Unbalanced servo gains	Check to see if the servo gains have been correctly adjusted.	Execute the advanced autotuning.
	Speed loop gain value (Pn100) too high	Check the speed loop gain (Pn100). Factory setting: $K_v = 40.0$ Hz	Reduce the speed loop gain (Pn100).
	Position loop gain value (Pn102) too high	Check the position loop gain (Pn102). Factory setting: $K_p = 40.0/s$	Reduce the position loop gain (Pn102).
	Incorrect speed loop integral time constant (Pn101)	Check the speed loop integral time constant (Pn101). Factory setting: $T_i = 20.0$ ms	Correct the speed loop integral time constant (Pn101).
	Incorrect moment of inertia ratio data (Pn103)	Check the moment of inertia ratio (Pn103).	Correct the moment of inertia ratio (Pn103).

(cont'd)

Problem	Probable Cause	Investigative Actions	Corrective Actions
Absolute Encoder Position Difference Error (The position saved in the host controller when the power was turned OFF is different from the position when the power was next turned ON.)	Noise interference due to incorrect cable specifications of encoder cable.	The encoder cable must be tinned annealed copper shielded twisted-pair or screened unshielded twisted-pair cable with a core of 0.12 mm ² min.	Use the specified encoder cable.
	Noise interference due to length of encoder cable.	Check the length of the encoder cable.	The encoder cable must be no more than 50 m.
	Noise interference due to damaged encoder cable.	Check if the encoder cable is bent and the sheath is damaged.	Replace the encoder cable and correct the cable layout.
	Excessive noise to the encoder cable.	Check if the encoder cable is bundled with a high-current line or near a high-current line.	Correct the cable layout so that no surge is applied.
	FG potential varies because of influence of machines such as welders at the servomotor.	Check if the machines are correctly grounded.	Ground machines correctly, and prevent diversion to the FG on the encoder side.
	SERVOPACK pulse counting error due to noise interference	Check if there is noise interference on the I/O signal line from the encoder.	Take measures against noise in the encoder wiring.
	Excessive vibration and shock to the encoder	Check if vibration from the machine occurred or servomotor installation is incorrect (mounting surface accuracy, fixing, alignment, etc.).	Reduce vibration from the machine, or secure the servomotor installation.
	An encoder fault occurred.	–	Replace the servomotor.
	A SERVOPACK fault occurred. (The pulse count does not change.)	–	Replace the SERVOPACK.
	Host controller multiturn data reading error		Check the error detection section of the host controller.
Check if the host controller is executing data parity checks.			Execute a multiturn data parity check.
Check noise in the cable between the SERVOPACK and the host controller.			Take measures against noise, and again execute a multiturn data parity check.
Overtravel (OT)	Forward or reverse run prohibited signal is input.	Check the external power supply (+24 V) voltage for the input signal.	Correct the external power supply (+24 V) voltage.
		Check if the overtravel limit switch operates properly.	Correct the overtravel limit switch.
		Check if the overtravel limit switch is wired correctly.	Correct the overtravel limit switch wiring.
		Check the settings for parameters Pn50A and Pn50B.	Correct the settings for parameters Pn50A and Pn50B.
	Forward or reverse run prohibited signal malfunctioning.	Check the fluctuation of the external power supply (+24 V) voltage for the input signal.	Stabilize the external power supply (+24 V) voltage.
		Check if the overtravel limit switch operates correctly.	Correct the overtravel limit switch.
		Check if the overtravel limit switch wiring is correct. (check for damaged cables or loose screws.)	Correct the overtravel limit switch wiring.
	Incorrect forward or reverse run prohibited signal (P-OT/N-OT) allocation (parameters Pn50A.3, Pn50B.0)	Check if the P-OT signal is allocated in Pn50A.3.	If another signal is allocated in Pn50A.3, allocate P-OT.
		Check if the N-OT signal is allocated in Pn50B.0.	If another signal is allocated in Pn50B.0, allocate N-OT.
	Incorrect servomotor stop method selection	Check the settings for parameters Pn001.0 and Pn001.1 when the servomotor power is OFF.	Select a servomotor stop method other than "coast to stop."
		Check the settings for parameters Pn001.0 and Pn001.1 when in torque control.	Select a servomotor stop method other than "coast to stop."

(cont'd)

Problem	Probable Cause	Investigative Actions	Corrective Actions
Improper Stop Position by Overtravel (OT) Signal	Improper limit switch position and dog length	—	Install the limit switch at the appropriate position.
	The overtravel limit switch position is too short for the coasting distance.	—	Install the overtravel limit switch at the appropriate position.
Position Error (Without Alarm)	Noise interference due to incorrect encoder cable specifications	The encoder cable must be tinned annealed copper shielded twisted-pair or screened unshielded twisted-pair cable with a core of 0.12 mm ² min.	Use the specified encoder cable.
	Noise interference due to length of encoder cable.	Check the length of the encoder cable.	The encoder cable must be no more than 50 m.
	Noise influence due to damaged encoder cable.	Check if the encoder cable is bent and the sheath is damaged.	Replace the encoder cable and modify the cable layout.
	Excessive noise to encoder cable.	Check if the encoder cable is bundled with a high-current line or near a high-current line.	Change the cable layout so that no surge is applied.
	The FG potential varies because of influence from machines on the servomotor side such as the welder.	Check if the machines are correctly grounded.	Properly ground the machines encoder FG.
	SERVOPACK pulse count error due to noise	Check if the I/O signal line from the encoder is influenced by noise.	Take measures against noise in the encoder wiring.
	Excessive vibration and shock to the encoder	Check if vibration from the machine occurred or servomotor installation is incorrect (mounting surface accuracy, fixing, alignment, etc.).	Reduce the machine vibration or mount the servomotor securely.
	Unsecured coupling between machine and servomotor	Check if a position error occurs at the coupling between machine and servomotor.	Secure the coupling between the machine and servomotor.
	Noise interference due to improper I/O signal cable specifications	The I/O signal cable must be tinned annealed copper shielded twisted-pair or screened unshielded twisted-pair cable with a core of 0.12 mm ² min.	Use input signal cable with the specified specifications.
	If the reference pulse input multiplication switching function is being used, noise may be causing the I/O signals (/PSEL and /PSELA) used for this function to be falsely detected.	The I/O signal cable must be tinned annealed copper shielded twisted-pair or screened unshielded twisted-pair cable with a core of 0.12 mm ² min.	Use input signal cable that satisfy specifications.
	Noise interference due to length of I/O signal cable	Check the I/O signal cable length.	The I/O signal cable length must be no more than 3 m.
	An encoder fault occurred. (The pulse count does not change.)	—	Replace the servomotor.
	A SERVOPACK fault occurred.	—	Replace the SERVOPACK.
Servomotor Overheated	Ambient operating temperature too high	Measure the servomotor ambient operating temperature.	Reduce the ambient operating temperature to 40°C or less.
	Servomotor surface dirty	Visually check the surface.	Clean dust and oil from the surface.
	Servomotor overloaded	Check the load status with monitor.	If overloaded, reduce load or replace with larger capacity SERVOPACK and servomotor.

Troubleshooting

11.1	Connection to Host Controller	11-2
11.1.1	Connection to MP2200/MP2300 Motion Module SVA-01	11-2
11.1.2	Connection to MP920 Servo Module SVA-01A	11-3
11.1.3	Connection to OMRON's Motion Control Unit	11-4
11.1.4	Connection to OMRON's Position Control Unit	11-5
11.1.5	Connection to MITSUBISHI's AD72 Positioning Module (SERVOPACK in Speed Control)	11-6
11.1.6	Connection to MITSUBISHI's AD75 Positioning Module (SERVOPACK in Position Control)	11-7
11.1.7	Connection to MITSUBISHI's QD75D□ Positioning Module (SERVOPACK in Position Control)	11-8
11.2	List of Parameters	11-9
11.2.1	Utility Functions	11-9
11.2.2	Parameters	11-10
11.3	List of Monitor Displays	11-35
11.4	Parameter Recording Table	11-36

11.1 Connection to Host Controller

The following figures show the connection examples to host controllers.

11.1.1 Connection to MP2200/MP2300 Motion Module SVA-01

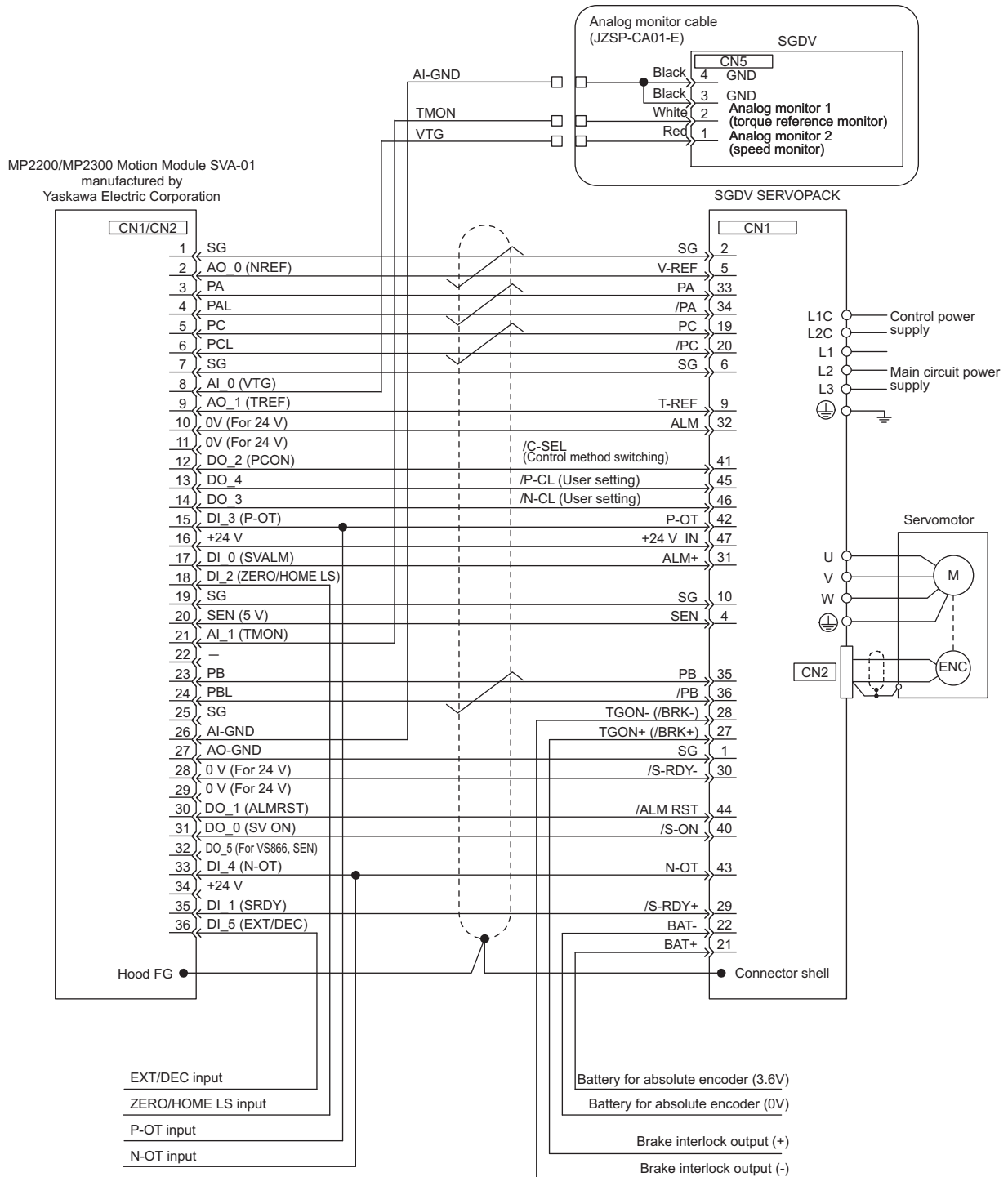

- Note 1. Connection cables (model: JEPMC-W2040-□□) to connect the SERVOPACK to the MP2200/MP2300 are prepared by Yaskawa. For details, refer to *Machine Controller MP2200/2300 Motion Module User's Manual* (No.: S1EP C880700 16).
2. Only signals related to the SGD SERVOPACK and MP2200/MP2300 Motion Module SVA-01 are shown in the diagram.
3. The main circuit power supply is a three-phase 200 VAC SERVOPACK input in the example.
4. Incorrect signal connections will cause damage to the machine controller and SERVOPACK. Wire all connections carefully.

5. Open the signal lines not to be used.
6. The above connection diagram shows the connections for only one axis. When using other axes, make connections to the SERVOPACK in the same way.
7. Short-circuit the normally closed (NC) input terminals that are not used at the I/O connector section of the machine controller.
8. Make the settings so that the servomotor can be turned ON/OFF by the Servo ON signal (/S-ON).
9. The SERVOPACK incorporates safety functions to protect people from the hazardous operation of the movable parts of the machines, reduce the risk, and ensure the safety of the machine in operation. Necessary circuits and settings are required in CN8 to use these functions. If these functions are not used, use the SERVOPACK with the enclosed safety function's jumper connector connected to CN8. For details, refer to 5.11 *Safety Function*.

11.1.2 Connection to MP920 Servo Module SVA-01A

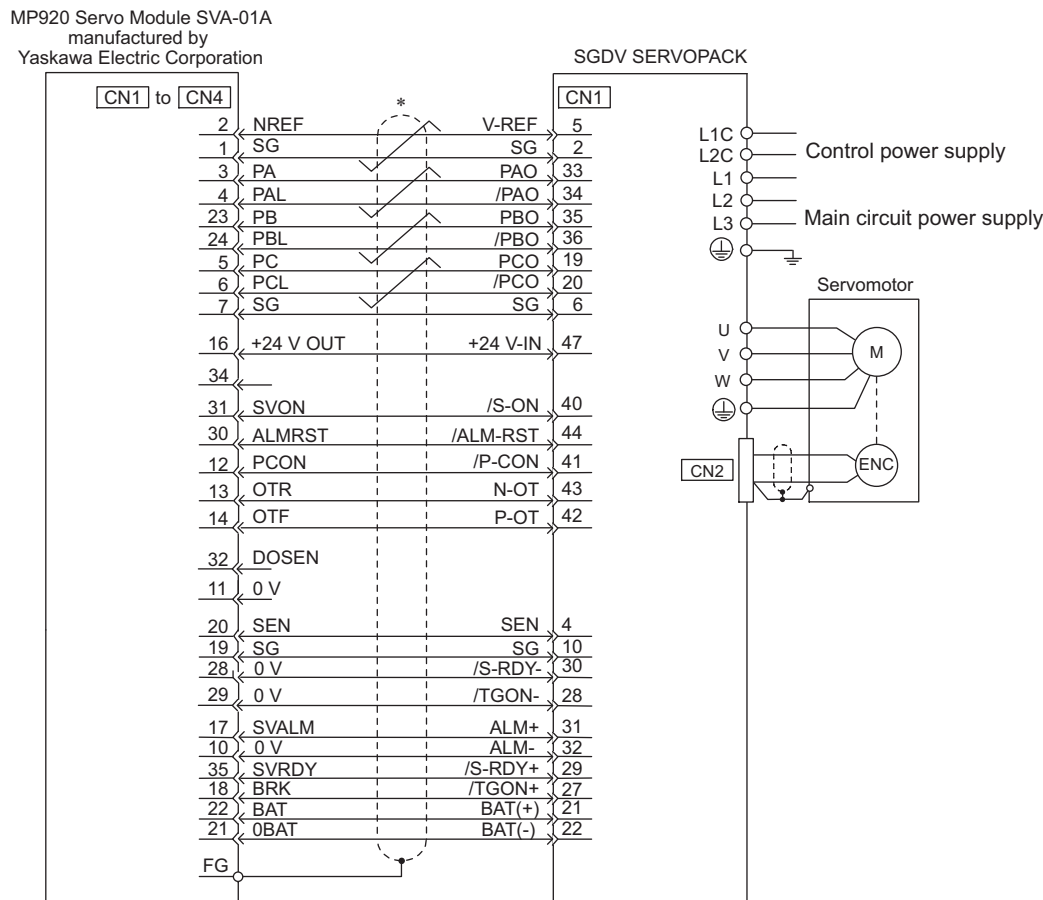

*  represents twisted-pair wires.

- Note 1. Connection cables (model: JEPMC-W6050-□□) to connect the SERVOPACK to the MP920 are prepared by Yaskawa. For details, refer to *Machine Controller MP920 User's Manual design and maintenance* (No.: SIEZ-C887-2.1).
2. Only signals related to the SGDV SERVOPACK and MP920 Servo Module SVA-01A are shown in the diagram.
 3. The main circuit power supply is a three-phase 200 VAC SERVOPACK input in the example.
 4. Incorrect signal connections will cause damage to the machine controller and SERVOPACK. Wire all connections carefully.
 5. Open the signal lines not to be used.
 6. The above connection diagram shows the connections for only one axis. When using other axes, make connections to the SERVOPACK in the same way.
 7. Short-circuit the normally closed (NC) input terminals that are not used at the I/O connector section of the machine controller.
 8. Make the settings so that the servomotor can be turned ON/OFF by the Servo ON signal (/S-ON).
 9. The SERVOPACK incorporates safety functions to protect people from the hazardous operation of the movable parts of the machines, reduce the risk, and ensure the safety of the machine in operation. Necessary circuits and settings are required in CN8 to use these functions. If these functions are not used, use the SERVOPACK with the enclosed safety function's jumper connector connected to CN8. For details, refer to 5.11 *Safety Function*.

11.1.3 Connection to OMRON's Motion Control Unit

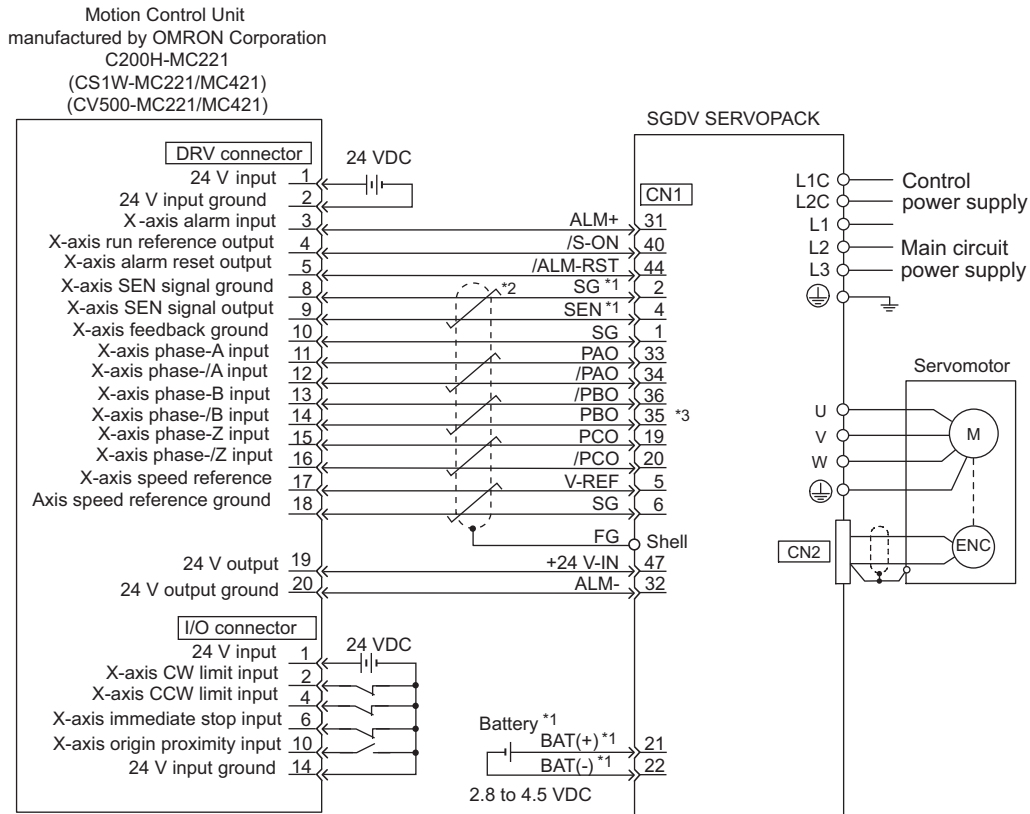

*1. Connect when an absolute encoder is used.

When the encoder cables with a battery case JUSP-BA01 are used, no battery is required for CN1 (between 21 and 22).

- For CN1: ER6VC3N (3.6 V, 2000 mA)
- Battery case: JUSP-BA01 (3.6 V, 1000 mA)

*2.  represents twisted-pair wires.

*3. This connection is to adjust the phase of the encoder output pulse.

Note 1. Only the signals that are related to the SGD V SERVOPACK and the OMRON Motion Control Unit are shown in the diagram.

- The main circuit power supply is a three-phase 200 VAC SERVOPACK input in the example.
- Incorrect signal connections will cause damage to the motion control unit and SERVOPACK. Wire all connections carefully.
- Open the signal lines not to be used.
- The above connection diagram shows the connections for only one axis. When using other axes, make connections to the SERVOPACK in the same way.
- Short-circuit the normally closed (NC) input terminals that are not used at the I/O connector section of the motion control unit.
- Make the settings so that the servomotor can be turned ON/OFF by the Servo ON signal (/S-ON).
- The SERVOPACK incorporates safety functions to protect people from the hazardous operation of the movable parts of the machines, reduce the risk, and ensure the safety of the machine in operation. Necessary circuits and settings are required in CN8 to use these functions. If these functions are not used, use the SERVOPACK with the enclosed safety function's jumper connector connected to CN8. For details, refer to 5.11 *Safety Function*.

11.1.4 Connection to OMRON's Position Control Unit

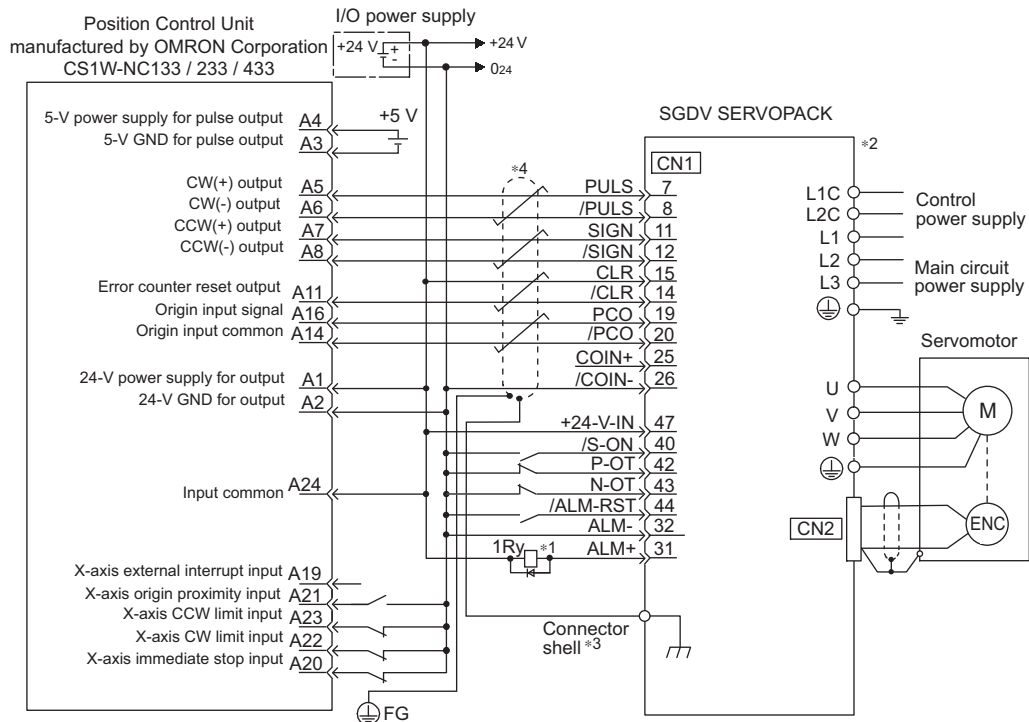

- *1. The ALM signal is output for about five seconds after the control power is turned ON. Take this into consideration when designing the power ON sequence. Also, use the ALM signal to actuate the alarm detection relay 1Ry to stop the main circuit power supply to the SERVOPACK.
- *2. Set parameter Pn200.0 to "1."
- *3. Connect the shielded wire to the connector shell.
- *4.  represents twisted-pair wires.

- Note 1. Only the signals related to the SGD V SERVOPACK and the OMRON Position Control Unit are shown in the diagram.
2. The main circuit power supply is a three-phase 200 VAC SERVOPACK input in the example.
 3. Incorrect signal connections will damage the Position Control Unit or SERVOPACK. Wire all connections carefully.
 4. Open the signal lines not to be used.
 5. The above connection diagram shows only X-axis connections. When using other axes, make connections to the SERVOPACK in the same way.
 6. Short-circuit the normally closed (NC) input terminals that are not used at the I/O connector section of the position control unit.
 7. Make the settings so that the servomotor can be turned ON/OFF by the Servo ON (/S-ON) signal.
 8. The SERVOPACK incorporates safety functions to protect people from the hazardous operation of the movable parts of the machines, reduce the risk, and ensure the safety of the machine in operation. Necessary circuits and settings are required in CN8 to use these functions. If these functions are not used, use the SERVOPACK with the enclosed safety function's jumper connector connected to CN8. For details, refer to 5.11 Safety Function.

11.1.5 Connection to MITSUBISHI's AD72 Positioning Module (SERVOPACK in Speed Control)

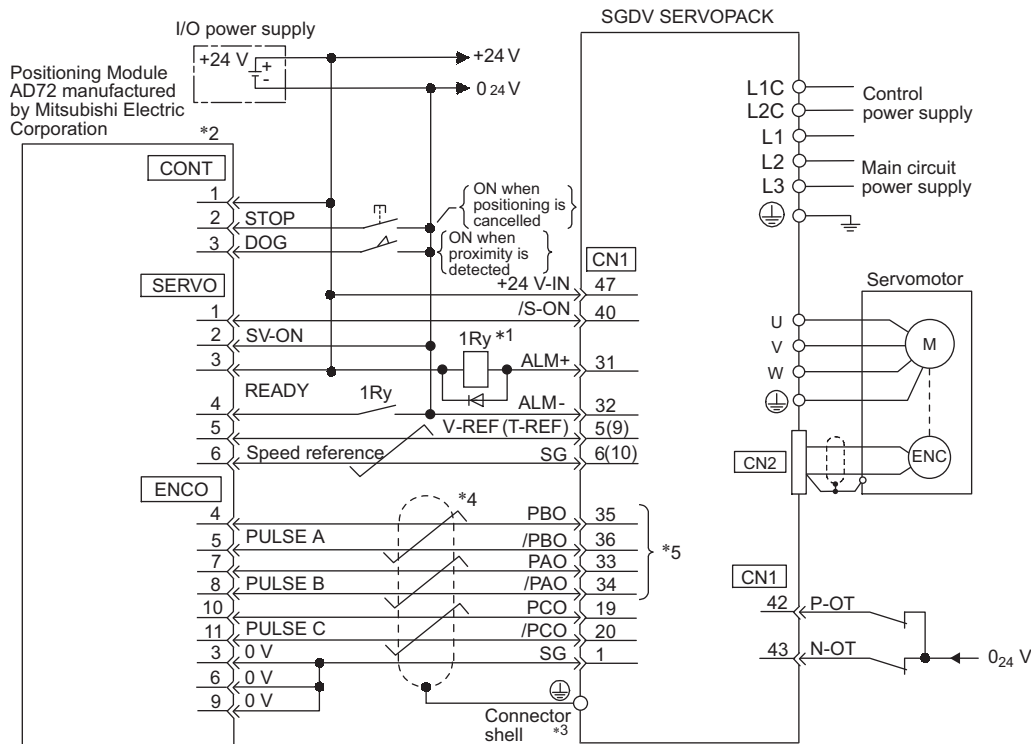

- *1. The ALM signal is output for about five seconds after the control power is turned ON. Take this into consideration when designing the power ON sequence. Also, use the ALM signal to actuate the alarm detection relay 1Ry to stop the main circuit power supply to the SERVOPACK.
- *2. Pin numbers are the same both for X axis and Y axis.
- *3. Connect the shielded wire to the connector shell.
- *4.  represents twisted-pair wires.
- *5. This connection is to adjust the phase of the encoder pulse output.

- Note 1. Only signals applicable to Yaskawa's SGDV SERVOPACK and Mitsubishi's AD72 Positioning Unit are shown in the diagram.
2. The main circuit power supply is a three-phase 200 VAC SERVOPACK input in the example.
 3. Incorrect wiring may damage the Positioning Module or SERVOPACK. Wire all connections carefully.
 4. Open the signal lines not to be used.
 5. The above connection diagram shows the connections for only one axis. When using other axes, make connections to the SERVOPACK in the same way.
 6. Short-circuit the normally closed (NC) input terminals that are not used at the I/O connector section of the positioning module.
 7. Make the settings so that the servo can be turned ON/OFF by the Servo ON (/S-ON) signal.
 8. The SERVOPACK incorporates safety functions to protect people from the hazardous operation of the movable parts of the machines, reduce the risk, and ensure the safety of the machine in operation. Necessary circuits and settings are required in CN8 to use these functions. If these functions are not used, use the SERVOPACK with the enclosed safety function's jumper connector connected to CN8. For details, refer to 5.11 Safety Function.

11.1.6 Connection to MITSUBISHI's AD75 Positioning Module (SERVOPACK in Position Control)

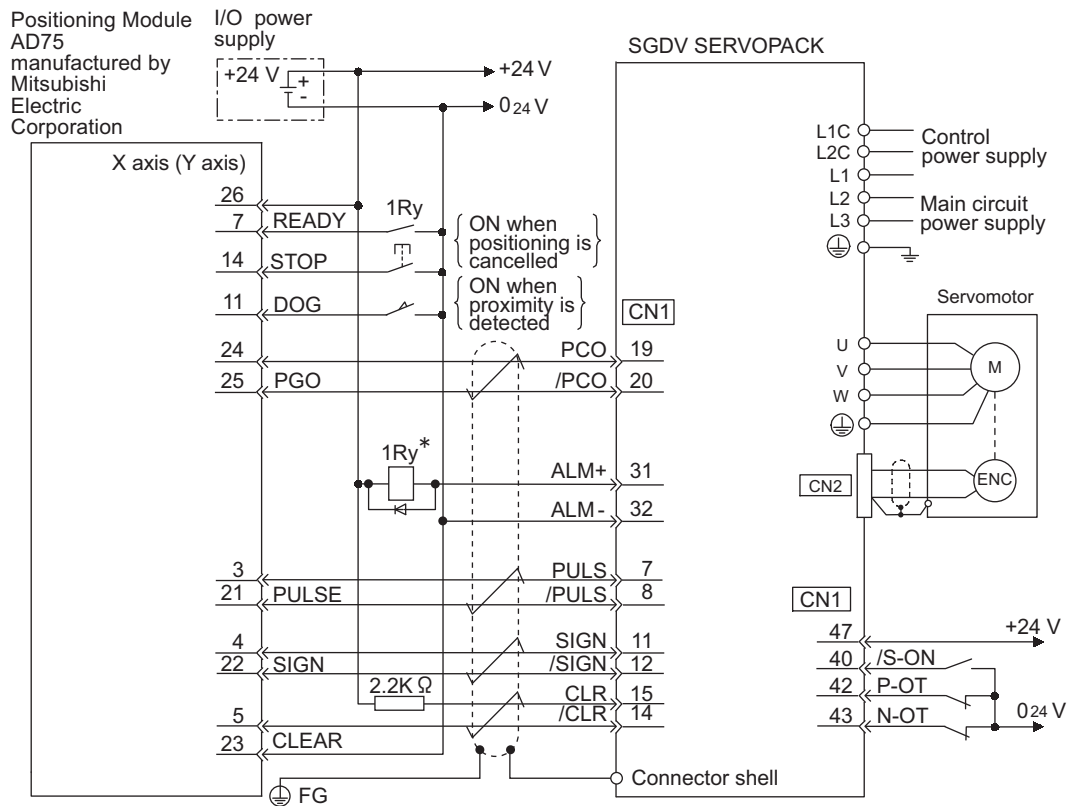

* The ALM signal is output for about five seconds when the control power is turned ON. Take this into consideration when designing the power ON sequence. Also, use the ALM signal to actuate the alarm detection relay 1Ry to stop the main circuit power supply to the SERVOPACK.

- Note 1. Only the signals related to the SGD SERVOPACK and the AD75 Mitsubishi Positioning Unit are shown in the diagram.
- The main circuit power supply is a three-phase 200 VAC SERVOPACK input in the example.
 - Incorrect signal connections will damage to the Positioning Module or SERVOPACK. Wire all connections carefully.
 - Open the signal lines not to be used.
 - The above connection diagram shows the connections for only one axis. When using other axes, make connections to the SERVOPACK in the same way.
 - Short-circuit the normally closed (NC) input terminals that are not used at the I/O connector section of the positioning module.
 - Make the settings so that the servomotor can be turned ON/OFF by the Servo ON (/S-ON) signal.
 - The SERVOPACK incorporates safety functions to protect people from the hazardous operation of the movable parts of the machines, reduce the risk, and ensure the safety of the machine in operation. Necessary circuits and settings are required in CN8 to use these functions. If these functions are not used, use the SERVOPACK with the enclosed safety function's jumper connector connected to CN8. For details, refer to 5.11 Safety Function.

11.1.7 Connection to MITSUBISHI's QD75D□ Positioning Module (SERVOPACK in Position Control)

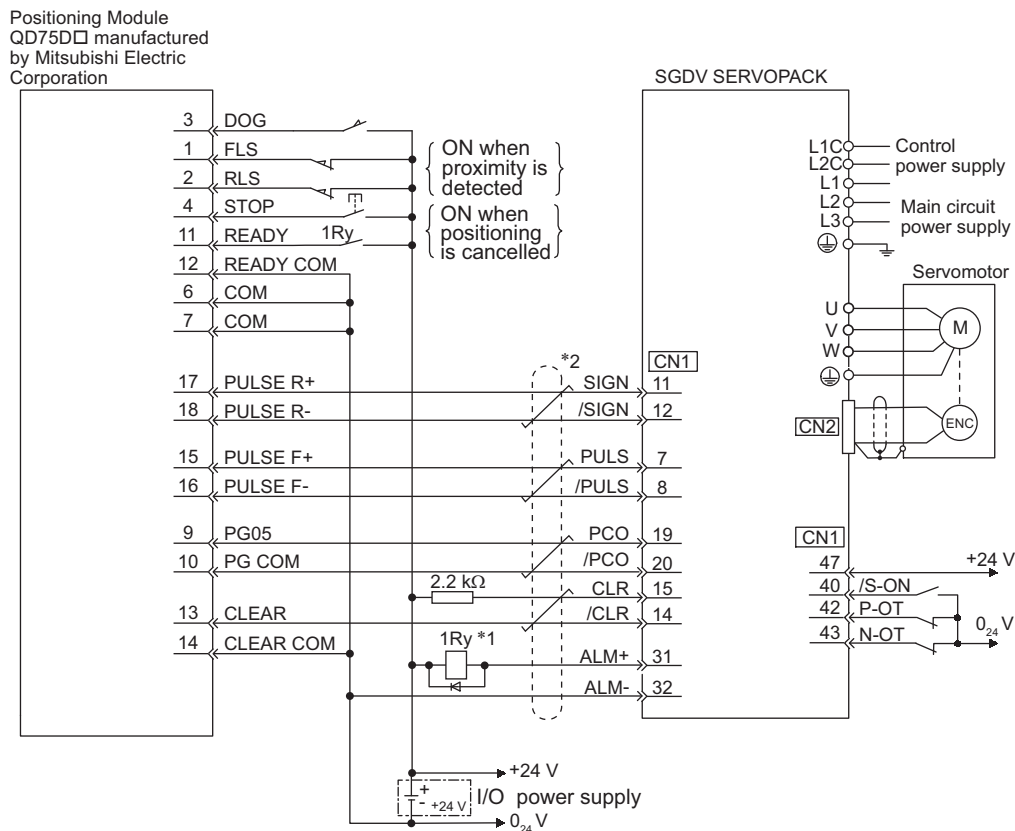

*1. The ALM signal is output for about five seconds when the control power is turned ON. Take this into consideration when designing the power ON sequence. Also, use the ALM signal to actuate the alarm detection relay 1Ry to stop the main circuit power supply to the SERVOPACK.

*2. represents twisted-pair wires.

- Note 1. Only the signals that are related to the SGD Servopack and the QD75D Mitsubishi Positioning Module are shown in the diagram.
- The main circuit power supply is a three-phase 200 VAC SERVOPACK input in the example.
 - Incorrect wiring may damage the Positioning Module or SERVOPACK. Wire all connections carefully.
 - Open the signal lines not to be used.
 - The above connection diagram shows the connections for only one axis. When using other axes, make connections to the SERVOPACK in the same way.
 - Short-circuit the normally closed (NC) input terminals that are not used at the I/O connector section of the positioning module.
 - Make the settings so that the servo can be turned ON/OFF by the Servo ON (/S-ON) signal.
 - The SERVOPACK incorporates safety functions to protect people from the hazardous operation of the movable parts of the machines, reduce the risk, and ensure the safety of the machine in operation. Necessary circuits and settings are required in CN8 to use these functions. If these functions are not used, use the SERVOPACK with the enclosed safety function's jumper connector connected to CN8. For details, refer to 5.11 *Safety Function*.

11.2 List of Parameters

11.2.1 Utility Functions

The following list shows the available utility functions.

Parameter No.	Function	Operation from the Panel Operator	Operation from the Digital Operator or SigmaWin+	Reference Section
Fn000	Alarm history display	○	○	7.2
Fn002	JOG operation	○	○	7.3
Fn003	Origin search	○	○	7.4
Fn004	Program JOG operation	○	○	7.5
Fn005	Initializing parameter settings	○	○	7.6
Fn006	Clearing alarm history	○	○	7.7
Fn008	Absolute encoder multiturn reset and encoder alarm reset	○	○	5.9.4
Fn009	Automatic tuning of analog (speed, torque) reference offset	○	○	5.3.2 5.5.2
Fn00A	Manual servo tuning of speed reference offset	○	○	5.3.2
Fn00B	Manual servo tuning of torque reference offset	○	○	5.5.2
Fn00C	Offset adjustment of analog monitor output	○	○	7.8
Fn00D	Gain adjustment of analog monitor output	○	○	7.9
Fn00E	Automatic offset-signal adjustment of the motor current detection signal	○	○	7.10
Fn00F	Manual offset-signal adjustment of the motor current detection signal	○	○	7.11
Fn010	Write prohibited setting	○	○	7.12
Fn011	Servomotor model display	○	○	7.13
Fn012	Software version display	○	○	7.14
Fn013	Multiturn limit value setting change when a multiturn limit disagreement alarm occurs	○	○	5.9.7
Fn014	Resetting configuration error in option modules	○	○	7.15
Fn01B	Vibration detection level initialization	○	○	7.16
Fn01E	Display of SERVOPACK and servomotor ID	×	○	7.17
Fn01F	Display of servomotor ID in feedback option module	×	○	7.18
Fn020	Origin setting	○	○	7.19
Fn030	Software reset	○	○	7.20
Fn200	Tuning-less levels setting	○	○	6.2.2
Fn201	Advanced autotuning	×	○	6.3.2
Fn202	Advanced autotuning by reference	×	○	6.4.2
Fn203	One-parameter tuning	○*	○	6.5.2
Fn204	Anti-resonance control adjustment function	×	○	6.6.2
Fn205	Vibration suppression function	×	○	6.7.2
Fn206	EasyFFT	○	○	7.21
Fn207	Online vibration monitor	○	○	7.22

○: Available ×: Not available

* The following functional restrictions apply to the panel operator.

Note: Execute the utility function with either a panel operator, digital operator, or SigmaWin+. If they are used together, "no_op" or "NO-OP" will be displayed when the utility function is executed.

11.2.2 Parameters

Parameter No.	Size	Name	Setting Range	Units	Factory Setting	When Enabled	Classification	Reference Section																												
Pn000	2	Basic Function Select Switch 0	0000 to 00B3	–	0000	After restart	Setup	–																												
	<div style="display: flex; justify-content: space-around; align-items: flex-start;"> <div style="text-align: center;"> <p>4th digit</p> <p>n. <input type="checkbox"/></p> </div> <div style="text-align: center;"> <p>3rd digit</p> <p><input type="checkbox"/></p> </div> <div style="text-align: center;"> <p>2nd digit</p> <p><input type="checkbox"/></p> </div> <div style="text-align: center;"> <p>1st digit</p> <p><input type="checkbox"/></p> </div> </div>																																			
	<table border="1" style="width: 100%; border-collapse: collapse;"> <thead> <tr style="background-color: #cccccc;"> <th colspan="2">Direction Selection</th> <th>Reference Section</th> </tr> </thead> <tbody> <tr> <td style="width: 5%;">0</td> <td>Sets CCW as forward direction.</td> <td rowspan="3" style="text-align: center; vertical-align: middle;">5.2.2</td> </tr> <tr> <td>1</td> <td>Sets CW as forward direction. (Reverse Rotation Mode)</td> </tr> <tr> <td>2 to 3</td> <td>Reserved (Do not change.)</td> </tr> </tbody> </table>								Direction Selection		Reference Section	0	Sets CCW as forward direction.	5.2.2	1	Sets CW as forward direction. (Reverse Rotation Mode)	2 to 3	Reserved (Do not change.)																		
	Direction Selection		Reference Section																																	
	0	Sets CCW as forward direction.	5.2.2																																	
	1	Sets CW as forward direction. (Reverse Rotation Mode)																																		
	2 to 3	Reserved (Do not change.)																																		
	<table border="1" style="width: 100%; border-collapse: collapse;"> <thead> <tr style="background-color: #cccccc;"> <th colspan="2">Control Method Selection</th> <th>Reference Section</th> </tr> </thead> <tbody> <tr> <td style="width: 5%;">0</td> <td>Speed control (analog reference)</td> <td rowspan="11" style="text-align: center; vertical-align: middle;">5.7</td> </tr> <tr> <td>1</td> <td>Position control (pulse train reference)</td> </tr> <tr> <td>2</td> <td>Torque control (analog reference)</td> </tr> <tr> <td>3</td> <td>Internal set speed control (contact reference)</td> </tr> <tr> <td>4</td> <td>Internal set speed control (contact reference) ↔ Speed control (analog reference)</td> </tr> <tr> <td>5</td> <td>Internal set speed control (contact reference) ↔ Position control (pulse train reference)</td> </tr> <tr> <td>6</td> <td>Internal set speed control (contact reference) ↔ Torque control (analog reference)</td> </tr> <tr> <td>7</td> <td>Position control (pulse train reference) ↔ Speed control (analog reference)</td> </tr> <tr> <td>8</td> <td>Position control (pulse train reference) ↔ Torque control (analog reference)</td> </tr> <tr> <td>9</td> <td>Torque control (analog reference) ↔ Speed control (analog reference)</td> </tr> <tr> <td>A</td> <td>Speed control (analog reference) ↔ Speed control with zero clamp function</td> </tr> <tr> <td>B</td> <td>Position control (pulse train reference) ↔ Position control with reference pulse inhibit function</td> </tr> </tbody> </table>								Control Method Selection		Reference Section	0	Speed control (analog reference)	5.7	1	Position control (pulse train reference)	2	Torque control (analog reference)	3	Internal set speed control (contact reference)	4	Internal set speed control (contact reference) ↔ Speed control (analog reference)	5	Internal set speed control (contact reference) ↔ Position control (pulse train reference)	6	Internal set speed control (contact reference) ↔ Torque control (analog reference)	7	Position control (pulse train reference) ↔ Speed control (analog reference)	8	Position control (pulse train reference) ↔ Torque control (analog reference)	9	Torque control (analog reference) ↔ Speed control (analog reference)	A	Speed control (analog reference) ↔ Speed control with zero clamp function	B	Position control (pulse train reference) ↔ Position control with reference pulse inhibit function
	Control Method Selection		Reference Section																																	
	0	Speed control (analog reference)	5.7																																	
	1	Position control (pulse train reference)																																		
	2	Torque control (analog reference)																																		
	3	Internal set speed control (contact reference)																																		
	4	Internal set speed control (contact reference) ↔ Speed control (analog reference)																																		
	5	Internal set speed control (contact reference) ↔ Position control (pulse train reference)																																		
6	Internal set speed control (contact reference) ↔ Torque control (analog reference)																																			
7	Position control (pulse train reference) ↔ Speed control (analog reference)																																			
8	Position control (pulse train reference) ↔ Torque control (analog reference)																																			
9	Torque control (analog reference) ↔ Speed control (analog reference)																																			
A	Speed control (analog reference) ↔ Speed control with zero clamp function																																			
B	Position control (pulse train reference) ↔ Position control with reference pulse inhibit function																																			
Reserved (Do not change.)																																				
Reserved (Do not change.)																																				

(cont'd)

Parameter No.	Size	Name	Setting Range	Units	Factory Setting	When Enabled	Classification	Reference Section
Pn001	2	Application Function Select Switch 1	0000 to 1122	–	0000	After restart	Setup	–

4th digit 3rd digit 2nd digit 1st digit
n.

Servomotor power OFF or Alarm Gr.1 Stop Mode		Reference Section
0	Stops the servomotor by applying DB (dynamic brake).	5.2.5
1	Stops the servomotor by applying DB and then releases DB.	
2	Makes the servomotor coast to a stop state without using the DB.	

Overtravel (OT) Stop Mode		Reference Section
0	Stops in accordance with the setting of Pn001.0.	5.2.3
1	Sets the torque of Pn406 to the maximum value, decelerates the servomotor to a stop, and then sets it to servolock state.	
2	Sets the torque of Pn406 to the maximum value, decelerates the servomotor to a stop, and then sets it to coasting state.	

AC/DC Power Input Selection		Reference Section
0	Applicable to AC power input: Input AC power supply through L1, L2, and L3 terminals.	3.1.4
1	Applicable to DC power input: Input DC power supply between B1/+ and –2, or input DC power supply between B1/+ and –.	

Warning Code Output Selection		Reference Section
0	ALO1, ALO2, and ALO3 output only alarm codes.	5.10.2
1	ALO1, ALO2, and ALO3 output both alarm codes and warning codes. While warning codes are output, ALM signal output remains ON (normal state).	

(cont'd)

Parameter No.	Size	Name	Setting Range	Units	Factory Setting	When Enabled	Classification	Reference Section		
Pn002	2	Application Function Select Switch 2	0000 to 4113	–	0000	After restart	Setup	–		
	4th digit 3rd digit 2nd digit 1st digit n. <input type="checkbox"/> <input type="checkbox"/> <input type="checkbox"/> <input type="checkbox"/>									
			Speed/Position Control Option (T-REF Terminal Allocation)						Reference Section	
			0	T-REF not allocated						–
			1	Uses T-REF as an external torque limit input.						5.8.3
			2	Uses T-REF as a torque feedforward input.						6.9.2
			3	Uses T-REF as an external torque limit input when /P-CL and /N-CL are ON.						5.8.4
			Torque Control Option (V-REF Terminal Allocation)						Reference Section	
			0	V-REF not allocated						5.5.4
			1	Uses V-REF as an external speed limit input.						
			Absolute Encoder Usage						Reference Section	
			0	Uses absolute encoder as an absolute encoder.						5.9
			1	Uses absolute encoder as an incremental encoder.						
			External Encoder Usage						Reference Section	
			0	Do not use external encoder.*						9.3.1
			1	Uses external encoder in forward rotation direction.						
			2	Reserved (Do not change.)						
			3	Uses external encoder in reversed rotation direction.						
			4	Reserved (Do not change.)						
	*The mode will be switched to semi-closed position control if Pn002.3 is set to 0.									

(cont'd)

Parameter No.	Size	Name	Setting Range	Units	Factory Setting	When Enabled	Classification	Reference Section																																			
Pn006	2	Application Function Select Switch 6	0000 to 005F	–	0002	Immediately	Setup	6.1.3																																			
	<div style="display: flex; justify-content: space-around; align-items: flex-start;"> <div style="text-align: center;"> 4th digit <input type="checkbox"/> </div> <div style="text-align: center;"> 3rd digit <input type="checkbox"/> </div> <div style="text-align: center;"> 2nd digit <input type="checkbox"/> </div> <div style="text-align: center;"> 1st digit <input type="checkbox"/> </div> </div>		<table border="1" style="width: 100%; border-collapse: collapse;"> <thead> <tr> <th colspan="2" style="background-color: #cccccc;">Analog Monitor 1 Signal Selection</th> </tr> </thead> <tbody> <tr><td>00</td><td>Motor rotating speed (1 V / 1000 min⁻¹)</td></tr> <tr><td>01</td><td>Speed reference (1 V / 1000 min⁻¹)</td></tr> <tr><td>02</td><td>Torque reference (1 V/100% rated torque)</td></tr> <tr><td>03</td><td>Position error (0.05 V/1 reference unit)</td></tr> <tr><td>04</td><td>Position amplifier error (after electronic gears) (0.05 V/ 1 encoder pulse unit)</td></tr> <tr><td>05</td><td>Position reference speed (1 V / 1000 min⁻¹)</td></tr> <tr><td>06</td><td>Reserved (Do not use.)</td></tr> <tr><td>07</td><td>Motor-load position error (0.01 V/1 reference unit)</td></tr> <tr><td>08</td><td>Positioning completion (positioning completed: 5 V, positioning not completed: 0 V)</td></tr> <tr><td>09</td><td>Speed feedforward (1 V / 1000 min⁻¹)</td></tr> <tr><td>0A</td><td>Torque feedforward (1 V/100% rated torque)</td></tr> <tr><td>0B</td><td>Active gain (1st gain: 1 V, 2nd gain: 2 V)</td></tr> <tr><td>0C</td><td>Completion of position reference (completed: 5 V, not completed: 0 V)</td></tr> <tr><td>0D</td><td>External encoder speed (1 V / 1000 min⁻¹: Values at motor shaft)</td></tr> <tr><td colspan="2" style="background-color: #cccccc;">Reserved (Do not change.)</td></tr> <tr><td colspan="2" style="background-color: #cccccc;">Reserved (Do not change.)</td></tr> </tbody> </table>							Analog Monitor 1 Signal Selection		00	Motor rotating speed (1 V / 1000 min ⁻¹)	01	Speed reference (1 V / 1000 min ⁻¹)	02	Torque reference (1 V/100% rated torque)	03	Position error (0.05 V/1 reference unit)	04	Position amplifier error (after electronic gears) (0.05 V/ 1 encoder pulse unit)	05	Position reference speed (1 V / 1000 min ⁻¹)	06	Reserved (Do not use.)	07	Motor-load position error (0.01 V/1 reference unit)	08	Positioning completion (positioning completed: 5 V, positioning not completed: 0 V)	09	Speed feedforward (1 V / 1000 min ⁻¹)	0A	Torque feedforward (1 V/100% rated torque)	0B	Active gain (1st gain: 1 V, 2nd gain: 2 V)	0C	Completion of position reference (completed: 5 V, not completed: 0 V)	0D	External encoder speed (1 V / 1000 min ⁻¹ : Values at motor shaft)	Reserved (Do not change.)		Reserved (Do not change.)	
	Analog Monitor 1 Signal Selection																																										
	00	Motor rotating speed (1 V / 1000 min ⁻¹)																																									
	01	Speed reference (1 V / 1000 min ⁻¹)																																									
	02	Torque reference (1 V/100% rated torque)																																									
	03	Position error (0.05 V/1 reference unit)																																									
	04	Position amplifier error (after electronic gears) (0.05 V/ 1 encoder pulse unit)																																									
	05	Position reference speed (1 V / 1000 min ⁻¹)																																									
	06	Reserved (Do not use.)																																									
	07	Motor-load position error (0.01 V/1 reference unit)																																									
	08	Positioning completion (positioning completed: 5 V, positioning not completed: 0 V)																																									
	09	Speed feedforward (1 V / 1000 min ⁻¹)																																									
	0A	Torque feedforward (1 V/100% rated torque)																																									
	0B	Active gain (1st gain: 1 V, 2nd gain: 2 V)																																									
0C	Completion of position reference (completed: 5 V, not completed: 0 V)																																										
0D	External encoder speed (1 V / 1000 min ⁻¹ : Values at motor shaft)																																										
Reserved (Do not change.)																																											
Reserved (Do not change.)																																											
Pn007	2	Application Function Select Switch 7	0000 to 005F	–	0000	Immediately	Setup	6.1.3																																			
	<div style="display: flex; justify-content: space-around; align-items: flex-start;"> <div style="text-align: center;"> 4th digit <input type="checkbox"/> </div> <div style="text-align: center;"> 3rd digit <input type="checkbox"/> </div> <div style="text-align: center;"> 2nd digit <input type="checkbox"/> </div> <div style="text-align: center;"> 1st digit <input type="checkbox"/> </div> </div>		<table border="1" style="width: 100%; border-collapse: collapse;"> <thead> <tr> <th colspan="2" style="background-color: #cccccc;">Analog Monitor 2 Signal Selection</th> </tr> </thead> <tbody> <tr><td>00</td><td>Motor rotating speed (1 V / 1000 min⁻¹)</td></tr> <tr><td>01</td><td>Speed reference (1 V / 1000 min⁻¹)</td></tr> <tr><td>02</td><td>Torque reference (1 V/100% rated torque)</td></tr> <tr><td>03</td><td>Position error (0.05 V/1 reference unit)</td></tr> <tr><td>04</td><td>Position amplifier error (after electronic gears) (0.05 V/ 1 encoder pulse unit)</td></tr> <tr><td>05</td><td>Position reference speed (1 V / 1000 min⁻¹)</td></tr> <tr><td>06</td><td>Reserved (Do not use.)</td></tr> <tr><td>07</td><td>Motor-load position error (0.01 V/1 reference unit)</td></tr> <tr><td>08</td><td>Positioning completion (positioning completed: 5 V, positioning not completed: 0 V)</td></tr> <tr><td>09</td><td>Speed feedforward (1 V / 1000 min⁻¹)</td></tr> <tr><td>0A</td><td>Torque feedforward (1 V/100% rated torque)</td></tr> <tr><td>0B</td><td>Active gain (1st gain: 1 V, 2nd gain: 2 V)</td></tr> <tr><td>0C</td><td>Completion of position reference (completed: 5 V not completed: 0 V)</td></tr> <tr><td>0D</td><td>External encoder speed (1 V / 1000 min⁻¹: Values at motor shaft)</td></tr> <tr><td colspan="2" style="background-color: #cccccc;">Reserved (Do not change.)</td></tr> <tr><td colspan="2" style="background-color: #cccccc;">Reserved (Do not change.)</td></tr> </tbody> </table>							Analog Monitor 2 Signal Selection		00	Motor rotating speed (1 V / 1000 min ⁻¹)	01	Speed reference (1 V / 1000 min ⁻¹)	02	Torque reference (1 V/100% rated torque)	03	Position error (0.05 V/1 reference unit)	04	Position amplifier error (after electronic gears) (0.05 V/ 1 encoder pulse unit)	05	Position reference speed (1 V / 1000 min ⁻¹)	06	Reserved (Do not use.)	07	Motor-load position error (0.01 V/1 reference unit)	08	Positioning completion (positioning completed: 5 V, positioning not completed: 0 V)	09	Speed feedforward (1 V / 1000 min ⁻¹)	0A	Torque feedforward (1 V/100% rated torque)	0B	Active gain (1st gain: 1 V, 2nd gain: 2 V)	0C	Completion of position reference (completed: 5 V not completed: 0 V)	0D	External encoder speed (1 V / 1000 min ⁻¹ : Values at motor shaft)	Reserved (Do not change.)		Reserved (Do not change.)	
	Analog Monitor 2 Signal Selection																																										
	00	Motor rotating speed (1 V / 1000 min ⁻¹)																																									
	01	Speed reference (1 V / 1000 min ⁻¹)																																									
	02	Torque reference (1 V/100% rated torque)																																									
	03	Position error (0.05 V/1 reference unit)																																									
	04	Position amplifier error (after electronic gears) (0.05 V/ 1 encoder pulse unit)																																									
	05	Position reference speed (1 V / 1000 min ⁻¹)																																									
	06	Reserved (Do not use.)																																									
	07	Motor-load position error (0.01 V/1 reference unit)																																									
	08	Positioning completion (positioning completed: 5 V, positioning not completed: 0 V)																																									
	09	Speed feedforward (1 V / 1000 min ⁻¹)																																									
	0A	Torque feedforward (1 V/100% rated torque)																																									
	0B	Active gain (1st gain: 1 V, 2nd gain: 2 V)																																									
0C	Completion of position reference (completed: 5 V not completed: 0 V)																																										
0D	External encoder speed (1 V / 1000 min ⁻¹ : Values at motor shaft)																																										
Reserved (Do not change.)																																											
Reserved (Do not change.)																																											

(cont'd)

Parameter No.	Size	Name	Setting Range	Units	Factory Setting	When Enabled	Classification	Reference Section	
Pn008	2	Application Function Select Switch 8	0000 to 7121	–	0000	After restart	Setup	–	
	Lowered Battery Voltage Alarm/Warning Selection								Reference Section
	0	Outputs alarm (A.830) for lowered battery voltage.							5.9.3
	1	Outputs warning (A.930) for lowered battery voltage.							
	Function Selection for Undervoltage								Reference Section
	0	Does not detect undervoltage.							5.2.7
	1	Detects warning and limits torque by host controller.							
	2	Detects warning and limits torque by Pn424 and Pn425. (Only in the SERVOPACK)							
	Warning Detection Selection								Reference Section
	0	Detects warning.							10.2.1
	1	Does not detect warning (except for A.971).							
Reserved (Do not change.)									
Pn009	2	Application Function Select Switch 9	0000 to 0111	–	0010	After restart	Tuning	–	
	Reserved (Do not change.)								
	Current Control Method Selection								Reference Section
	0	Current control method 1							6.8.3
	1	Current control method 2							
	Speed Detection Method Selection								Reference Section
	0	Speed detection 1							6.8.5
	1	Speed detection 2							
	Reserved (Do not change.)								

(cont'd)

Parameter No.	Size	Name	Setting Range	Units	Factory Setting	When Enabled	Classification	Reference Section								
Pn00B	2	Application Function Select Switch B	0000 to 1111	–	0000	After restart	Setup	–								
	4th digit 3rd digit 2nd digit 1st digit n. <input type="checkbox"/> <input type="checkbox"/> <input type="checkbox"/> <input type="checkbox"/>		<table border="1"> <tr> <th colspan="2">Parameter Display Selection</th> <th>Reference Section</th> </tr> <tr> <td>0</td> <td>Setup parameters</td> <td rowspan="2">2.3.1</td> </tr> <tr> <td>1</td> <td>All parameters</td> </tr> </table>						Parameter Display Selection		Reference Section	0	Setup parameters	2.3.1	1	All parameters
	Parameter Display Selection		Reference Section													
	0	Setup parameters	2.3.1													
	1	All parameters														
			<table border="1"> <tr> <th colspan="2">Alarm Gr.2 Stop Method Selection</th> <th>Reference Section</th> </tr> <tr> <td>0</td> <td>Stops the motor by setting the speed reference to "0".</td> <td rowspan="2">5.2.5</td> </tr> <tr> <td>1</td> <td>Same setting as Pn001.0 (Stops the motor by applying DB or by coasting).</td> </tr> </table>						Alarm Gr.2 Stop Method Selection		Reference Section	0	Stops the motor by setting the speed reference to "0".	5.2.5	1	Same setting as Pn001.0 (Stops the motor by applying DB or by coasting).
	Alarm Gr.2 Stop Method Selection		Reference Section													
	0	Stops the motor by setting the speed reference to "0".	5.2.5													
	1	Same setting as Pn001.0 (Stops the motor by applying DB or by coasting).														
			<table border="1"> <tr> <th colspan="2">Power Supply Method for Three-phase SERVOPACK</th> <th>Reference Section</th> </tr> <tr> <td>0</td> <td>Three-phase power supply</td> <td rowspan="2">3.1.3</td> </tr> <tr> <td>1</td> <td>Single-phase power supply</td> </tr> </table>						Power Supply Method for Three-phase SERVOPACK		Reference Section	0	Three-phase power supply	3.1.3	1	Single-phase power supply
Power Supply Method for Three-phase SERVOPACK		Reference Section														
0	Three-phase power supply	3.1.3														
1	Single-phase power supply															
		Reserved (Do not change.)														
		Reserved (Do not change.)														
		Reserved (Do not change.)														
		Reserved (Do not change.)														
		Reserved (Do not change.)														
		Reserved (Do not change.)														
Pn00C	2	Application Function Select Switch C	0000 to 0111	–	0000	After restart	Setup	4.6, 4.6.1								
	4th digit 3rd digit 2nd digit 1st digit n. <input type="checkbox"/> <input type="checkbox"/> <input type="checkbox"/> <input type="checkbox"/>		<table border="1"> <tr> <th colspan="2">Selection of Test without a Motor</th> </tr> <tr> <td>0</td> <td>Disables test without a motor.</td> </tr> <tr> <td>1</td> <td>Enables test without a motor.</td> </tr> </table>						Selection of Test without a Motor		0	Disables test without a motor.	1	Enables test without a motor.		
	Selection of Test without a Motor															
	0	Disables test without a motor.														
	1	Enables test without a motor.														
			<table border="1"> <tr> <th colspan="2">Encoder Resolution for Test without a Motor</th> </tr> <tr> <td>0</td> <td>13 bits</td> </tr> <tr> <td>1</td> <td>20 bits</td> </tr> </table>						Encoder Resolution for Test without a Motor		0	13 bits	1	20 bits		
	Encoder Resolution for Test without a Motor															
	0	13 bits														
	1	20 bits														
			<table border="1"> <tr> <th colspan="2">Encoder Type for Test without a Motor</th> </tr> <tr> <td>0</td> <td>Incremental encoder</td> </tr> <tr> <td>1</td> <td>Absolute encoder</td> </tr> </table>						Encoder Type for Test without a Motor		0	Incremental encoder	1	Absolute encoder		
Encoder Type for Test without a Motor																
0	Incremental encoder															
1	Absolute encoder															
		Reserved (Do not change.)														
		Reserved (Do not change.)														
		Reserved (Do not change.)														
		Reserved (Do not change.)														
		Reserved (Do not change.)														
		Reserved (Do not change.)														
Pn00D	2	Application Function Select Switch D	0000 to 1001	–	0000	Immediately	Setup	–								
	4th digit 3rd digit 2nd digit 1st digit n. <input type="checkbox"/> <input type="checkbox"/> <input type="checkbox"/> <input type="checkbox"/>		Reserved (Do not change.)													
			Reserved (Do not change.)													
			Reserved (Do not change.)													
			<table border="1"> <tr> <th colspan="2">Overtravel Warning Detection Selection</th> <th>Reference Section</th> </tr> <tr> <td>0</td> <td>Does not detect overtravel warning.</td> <td rowspan="2">5.2.3</td> </tr> <tr> <td>1</td> <td>Detects overtravel warning.</td> </tr> </table>						Overtravel Warning Detection Selection		Reference Section	0	Does not detect overtravel warning.	5.2.3	1	Detects overtravel warning.
Overtravel Warning Detection Selection		Reference Section														
0	Does not detect overtravel warning.	5.2.3														
1	Detects overtravel warning.															

(cont'd)

Parameter No.	Size	Name	Setting Range	Units	Factory Setting	When Enabled	Classification	Reference Section					
Pn010	2	Axis Address Selection (for UART/USB communications)	0000 to 007F	–	0001	After restart	Setup	–					
Pn081	2	Application Function Select Switch 81	0000 to 1111	–	0000	After restart	Setup	9.1.5					
	<table border="1" style="margin-left: 20px;"> <thead> <tr> <th colspan="2">Phase-C Pulse Output Selection</th> </tr> </thead> <tbody> <tr> <td>0</td> <td>Outputs phase-C pulse only in forward direction.</td> </tr> <tr> <td>1</td> <td>Outputs phase-C pulse in forward and reverse direction.</td> </tr> </tbody> </table>								Phase-C Pulse Output Selection		0	Outputs phase-C pulse only in forward direction.	1
Phase-C Pulse Output Selection													
0	Outputs phase-C pulse only in forward direction.												
1	Outputs phase-C pulse in forward and reverse direction.												
Pn100	2	Speed Loop Gain	10 to 20000	0.1 Hz	400	Immediately	Tuning	6.8.1					
Pn101	2	Speed Loop Integral Time Constant	15 to 51200	0.01 ms	2000	Immediately	Tuning						
Pn102	2	Position Loop Gain	10 to 20000	0.1/s	400	Immediately	Tuning						
Pn103	2	Moment of Inertia Ratio	0 to 20000	1%	100	Immediately	Tuning						
Pn104	2	2nd Speed Loop Gain	10 to 20000	0.1 Hz	400	Immediately	Tuning						
Pn105	2	2nd Speed Loop Integral Time Constant	15 to 51200	0.01 ms	2000	Immediately	Tuning						
Pn106	2	2nd Position Loop Gain	10 to 20000	0.1/s	400	Immediately	Tuning	6.9.1					
Pn109	2	Feedforward Gain	0 to 100	1%	0	Immediately	Tuning						
Pn10A	2	Feedforward Filter Time Constant	0 to 6400	0.01 ms	0	Immediately	Tuning						

(cont'd)

Parameter No.	Size	Name	Setting Range	Units	Factory Setting	When Enabled	Classification	Reference Section	
Pn10B	2	Application Function for Gain Select Switch	0000 to 5334	–	0000	–	–	–	
		4th digit □ 3rd digit □ 2nd digit □ 1st digit □ n. □							
		Mode Switch Selection				When Enabled	Classification	Reference Section	
		0	Uses internal torque reference as the condition (Level setting: Pn10C).			Immediately	Setup	6.9.5	
		1	Uses speed reference as the condition (Level setting: Pn10D).						
		2	Uses acceleration as the condition (Level setting: Pn10E).						
		3	Uses position error as the condition (Level setting: Pn10F).						
		4	No mode switch function available.						
		Speed Loop Control Method				When Enabled	Classification	Reference Section	
		0	PI control			After restart	Setup	–	
	1	I-P control							
	2 to 3	Reserved (Do not change.)							
	Reserved (Do not change.)								
	Reserved (Do not change.)								
Pn10C	2	Mode Switch (torque reference)	0 to 800	1%	200	Immediately	Tuning	6.9.5	
Pn10D	2	Mode Switch (speed reference)	0 to 10000	1 min ⁻¹	0	Immediately	Tuning		
Pn10E	2	Mode Switch (acceleration)	0 to 30000	1 min ⁻¹ /s	0	Immediately	Tuning		
Pn10F	2	Mode Switch (position error)	0 to 10000	1 reference unit	0	Immediately	Tuning		
Pn11F	2	Position Integral Time Constant	0 to 50000	0.1 ms	0	Immediately	Tuning	6.9.7	
Pn121	2	Friction Compensation Gain	10 to 1000	1%	100	Immediately	Tuning	6.8.2	
Pn122	2	2nd Gain for Friction Compensation	10 to 1000	1%	100	Immediately	Tuning		
Pn123	2	Friction Compensation Coefficient	0 to 100	1%	0	Immediately	Tuning		
Pn124	2	Friction Compensation Frequency Correction	-10000 to 10000	0.1 Hz	0	Immediately	Tuning	6.8.2	
Pn125	2	Friction Compensation Gain Correction	1 to 1000	1%	100	Immediately	Tuning		
Pn131	2	Gain Switching Time 1	0 to 65535	1 ms	0	Immediately	Tuning	6.8.1	
Pn132	2	Gain Switching Time 2	0 to 65535	1 ms	0	Immediately	Tuning		
Pn135	2	Gain Switching Waiting Time 1	0 to 65535	1 ms	0	Immediately	Tuning		
Pn136	2	Gain Switching Waiting Time 2	0 to 65535	1 ms	0	Immediately	Tuning		

(cont'd)

Parameter No.	Size	Name	Setting Range	Units	Factory Setting	When Enabled	Classification	Reference Section	
Pn139	2	Automatic Gain Changeover Related Switch 1	0000 to 0052	–	0000	Immediately	Tuning	6.8.1	
	4th digit 3rd digit 2nd digit 1st digit n. <input type="checkbox"/> <input type="checkbox"/> <input type="checkbox"/> <input type="checkbox"/>								
			Gain Switching Selection Switch						
			0	Manual gain switching Changes gain manually using external input signal (/G-SEL).					
			1	Reserved (Do not change.)					
			2	Automatic gain switching pattern 1 Changes automatically 1st gain to 2nd gain when the switching condition A is satisfied. Changes automatically 2nd gain to 1st gain when the switching condition A is not satisfied.					
			Gain Switching Condition A						
			0	Positioning completion signal (/COIN) ON					
			1	Positioning completion signal (/COIN) OFF					
			2	Positioning near signal (/NEAR) ON					
		3	Positioning near signal (/NEAR) OFF						
		4	Position reference filter output = 0 and reference pulse input OFF						
		5	Position reference pulse input ON						
		Reserved (Do not change.)							
		Reserved (Do not change.)							
Pn13D	2	Current Gain Level	100 to 2000	1%	2000	Immediately	Tuning	6.8.4	
Pn140	2	Model Following Control Related Switch	0000 to 1121	–	0100	Immediately	Tuning	–	
	4th digit 3rd digit 2nd digit 1st digit n. <input type="checkbox"/> <input type="checkbox"/> <input type="checkbox"/> <input type="checkbox"/>								
			Model Following Control Selection						
			0	Does not use model following control.					
			1	Uses model following control.					
			Vibration Suppression Selection						
			0	Does not perform vibration suppression.					
			1	Performs vibration suppression over the specified frequency.					
			2	Performs vibration suppression over two different kinds of frequencies.					
			Vibration Suppression Adjustment Selection						
		0	Does not adjust vibration suppression automatically using utility function.					Reference Section	
		1	Adjusts vibration suppression automatically using utility function.					6.3.1, 6.4.1, 6.5.1, 6.7.1	
		Selection of Speed Feedforward (VFF) / Torque Feedforward (TFF)							
		0	Does not use model following control and speed/torque feedforward together.					Reference Section	
		1	Uses model following control and speed/torque feedforward together.					6.3.1, 6.4.1	
Pn141	2	Model Following Control Gain	10 to 20000	0.1/s	500	Immediately	Tuning	–	
Pn142	2	Model Following Control Gain Compensation	500 to 2000	0.1%	1000	Immediately	Tuning	–	
Pn143	2	Model Following Control Bias (Forward Direction)	0 to 10000	0.1%	1000	Immediately	Tuning	–	

(cont'd)

Parameter No.	Size	Name	Setting Range	Units	Factory Setting	When Enabled	Classification	Reference Section																							
Pn144	2	Model Following Control Bias (Reverse Direction)	0 to 10000	0.1%	1000	Immediately	Tuning	–																							
Pn145	2	Vibration Suppression 1 Frequency A	10 to 2500	0.1 Hz	500	Immediately	Tuning	–																							
Pn146	2	Vibration Suppression 1 Frequency B	10 to 2500	0.1 Hz	700	Immediately	Tuning	–																							
Pn147	2	Model Following Control Speed Feedforward Compensation	0 to 10000	0.1%	1000	Immediately	Tuning	–																							
Pn148	2	2nd Model Following Control Gain	10 to 20000	0.1/s	500	Immediately	Tuning	–																							
Pn149	2	2nd Model Following Control Gain Compensation	500 to 2000	0.1%	1000	Immediately	Tuning	–																							
Pn14A	2	Vibration Suppression 2 Frequency	10 to 2000	0.1 Hz	800	Immediately	Tuning	–																							
Pn14B	2	Vibration Suppression 2 Compensation	10 to 1000	1%	100	Immediately	Tuning	–																							
Pn14F	2	Control Related Switch	0000 to 0011	–	0011	After restart	Tuning	–																							
	<div style="display: flex; justify-content: space-around; align-items: flex-start;"> <div style="text-align: center;"> <p>4th digit</p><input type="checkbox"/></div> <div style="text-align: center;"> <p>3rd digit</p><input type="checkbox"/></div> <div style="text-align: center;"> <p>2nd digit</p><input type="checkbox"/></div> <div style="text-align: center;"> <p>1st digit</p><input type="checkbox"/></div> </div> <div style="margin-left: 20px;"> <p>n.</p> </div>		<table border="1" style="width: 100%; border-collapse: collapse;"> <thead> <tr> <th colspan="2">Model Following Control Type Selection</th> <th>Reference Section</th> </tr> </thead> <tbody> <tr> <td style="text-align: center;">0</td> <td>Model Following Control 1</td> <td rowspan="2" style="text-align: center; vertical-align: middle;">6.3.1, 6.4.1, 6.5.1</td> </tr> <tr> <td style="text-align: center;">1</td> <td>Model Following Control 2</td> </tr> <tr> <th colspan="2">Tuning-less Type Selection</th> <th>Reference Section</th> </tr> <tr> <td style="text-align: center;">0</td> <td>Tuning-less type 1</td> <td rowspan="2" style="text-align: center; vertical-align: middle;">6.2.2</td> </tr> <tr> <td style="text-align: center;">1</td> <td>Tuning-less type 2</td> </tr> <tr> <td colspan="3">Reserved (Do not change.)</td> </tr> <tr> <td colspan="3">Reserved (Do not change.)</td> </tr> </tbody> </table>							Model Following Control Type Selection		Reference Section	0	Model Following Control 1	6.3.1, 6.4.1, 6.5.1	1	Model Following Control 2	Tuning-less Type Selection		Reference Section	0	Tuning-less type 1	6.2.2	1	Tuning-less type 2	Reserved (Do not change.)			Reserved (Do not change.)		
	Model Following Control Type Selection		Reference Section																												
	0	Model Following Control 1	6.3.1, 6.4.1, 6.5.1																												
	1	Model Following Control 2																													
Tuning-less Type Selection		Reference Section																													
0	Tuning-less type 1	6.2.2																													
1	Tuning-less type 2																														
Reserved (Do not change.)																															
Reserved (Do not change.)																															

(cont'd)

Parameter No.	Size	Name	Setting Range	Units	Factory Setting	When Enabled	Classification	Reference Section		
Pn162	2	Anti-Resonance Gain Compensation	1 to 1000	1%	100	Immediately	Tuning	–		
Pn163	2	Anti-Resonance Damping Gain	0 to 300	1%	0	Immediately	Tuning	–		
Pn164	2	Anti-Resonance Filter Time Constant 1 Compensation	-1000 to 1000	0.01 ms	0	Immediately	Tuning	–		
Pn165	2	Anti-Resonance Filter Time Constant 2 Compensation	-1000 to 1000	0.01 ms	0	Immediately	Tuning	–		
Pn170	2	Tuning-less Function Related Switch	0000 to 2411	–	1401	–	–	–		
	4th digit 3rd digit 2nd digit 1st digit n. <input type="checkbox"/> <input type="checkbox"/> <input type="checkbox"/> <input type="checkbox"/>									
			Tuning-less Function Selection				When Enabled	Classification	Reference Section	
			0 Disables tuning-less function.				After restart	Setup	6.2	
			1 Enables tuning-less function.							
		Control Method during Speed Control				When Enabled	Classification	Reference Section		
		0 Uses as speed control.				After restart	Setup	6.2		
		1 Uses as speed control and uses the host controller for position control.								
		Rigidity Level				When Enabled	Classification	Reference Section		
		0 to 4 Sets rigidity level.				Immediately	Setup	6.2		
		Load Level				When Enabled	Classification	Reference Section		
		0 to 2 Sets load level.				Immediately	Setup	6.2		

(cont'd)

Parameter No.	Size	Name	Setting Range	Units	Factory Setting	When Enabled	Classification	Reference Section																				
Pn200	2	Position Control Reference Form Selection Switch	0000 to 2236	–	0000	After restart	Setup	–																				
	4th digit <input type="checkbox"/> 3rd digit <input type="checkbox"/> 2nd digit <input type="checkbox"/> 1st digit <input type="checkbox"/> n. <input type="checkbox"/> <input type="checkbox"/> <input type="checkbox"/> <input type="checkbox"/>		<table border="1"> <thead> <tr> <th colspan="2">Reference Pulse Form</th> <th>Reference Section</th> </tr> </thead> <tbody> <tr> <td>0</td> <td>Sign + Pulse train, positive logic</td> <td rowspan="6">5.4.1</td> </tr> <tr> <td>1</td> <td>CW + CCW pulse train, positive logic</td> </tr> <tr> <td>2</td> <td>Two-phase pulse train with 90° phase differential (phase A + phase B) ×1, positive logic</td> </tr> <tr> <td>3</td> <td>Two-phase pulse train with 90° phase differential (phase A + phase B) ×2, positive logic</td> </tr> <tr> <td>4</td> <td>Two-phase pulse train with 90° phase differential (phase A + phase B) ×4, positive logic</td> </tr> <tr> <td>5</td> <td>Sign + Pulse train, negative logic</td> </tr> <tr> <td>6</td> <td>CW + CCW pulse train, negative logic</td> <td></td> </tr> </tbody> </table>						Reference Pulse Form		Reference Section	0	Sign + Pulse train, positive logic	5.4.1	1	CW + CCW pulse train, positive logic	2	Two-phase pulse train with 90° phase differential (phase A + phase B) ×1, positive logic	3	Two-phase pulse train with 90° phase differential (phase A + phase B) ×2, positive logic	4	Two-phase pulse train with 90° phase differential (phase A + phase B) ×4, positive logic	5	Sign + Pulse train, negative logic	6	CW + CCW pulse train, negative logic		
	Reference Pulse Form		Reference Section																									
	0	Sign + Pulse train, positive logic	5.4.1																									
	1	CW + CCW pulse train, positive logic																										
	2	Two-phase pulse train with 90° phase differential (phase A + phase B) ×1, positive logic																										
	3	Two-phase pulse train with 90° phase differential (phase A + phase B) ×2, positive logic																										
	4	Two-phase pulse train with 90° phase differential (phase A + phase B) ×4, positive logic																										
	5	Sign + Pulse train, negative logic																										
	6	CW + CCW pulse train, negative logic																										
			<table border="1"> <thead> <tr> <th colspan="2">Clear Signal Form</th> <th>Reference Section</th> </tr> </thead> <tbody> <tr> <td>0</td> <td>Clears position error when the signal is at high level.</td> <td rowspan="4">5.4.2</td> </tr> <tr> <td>1</td> <td>Clears position error at the rising edge of the signal.</td> </tr> <tr> <td>2</td> <td>Clears position error when the signal is at low level.</td> </tr> <tr> <td>3</td> <td>Clears position error at the falling edge of the signal.</td> </tr> </tbody> </table>						Clear Signal Form		Reference Section	0	Clears position error when the signal is at high level.	5.4.2	1	Clears position error at the rising edge of the signal.	2	Clears position error when the signal is at low level.	3	Clears position error at the falling edge of the signal.								
	Clear Signal Form		Reference Section																									
0	Clears position error when the signal is at high level.	5.4.2																										
1	Clears position error at the rising edge of the signal.																											
2	Clears position error when the signal is at low level.																											
3	Clears position error at the falling edge of the signal.																											
		<table border="1"> <thead> <tr> <th colspan="2">Clear Operation</th> <th>Reference Section</th> </tr> </thead> <tbody> <tr> <td>0</td> <td>Clears position error at the baseblock (servomotor power OFF or alarm occurred).</td> <td rowspan="3">5.4.2</td> </tr> <tr> <td>1</td> <td>Does not clear position error (possible to clear error counter only with CLR signal).</td> </tr> <tr> <td>2</td> <td>Clears position error when an alarm occurs.</td> </tr> </tbody> </table>						Clear Operation		Reference Section	0	Clears position error at the baseblock (servomotor power OFF or alarm occurred).	5.4.2	1	Does not clear position error (possible to clear error counter only with CLR signal).	2	Clears position error when an alarm occurs.											
Clear Operation		Reference Section																										
0	Clears position error at the baseblock (servomotor power OFF or alarm occurred).	5.4.2																										
1	Does not clear position error (possible to clear error counter only with CLR signal).																											
2	Clears position error when an alarm occurs.																											
		<table border="1"> <thead> <tr> <th colspan="2">Filter Selection</th> <th>Reference Section</th> </tr> </thead> <tbody> <tr> <td>0</td> <td>Uses reference input filter 1 for line driver signal (to 1 Mpps).</td> <td rowspan="3">5.4.1</td> </tr> <tr> <td>1</td> <td>Uses reference input filter for open collector signal (to 200 kpps).</td> </tr> <tr> <td>2</td> <td>Uses reference input filter 2 for line driver signal (1 Mpps to 4 Mpps).</td> </tr> </tbody> </table>						Filter Selection		Reference Section	0	Uses reference input filter 1 for line driver signal (to 1 Mpps).	5.4.1	1	Uses reference input filter for open collector signal (to 200 kpps).	2	Uses reference input filter 2 for line driver signal (1 Mpps to 4 Mpps).											
Filter Selection		Reference Section																										
0	Uses reference input filter 1 for line driver signal (to 1 Mpps).	5.4.1																										
1	Uses reference input filter for open collector signal (to 200 kpps).																											
2	Uses reference input filter 2 for line driver signal (1 Mpps to 4 Mpps).																											
Pn205	2	Multiturn Limit Setting	0 to 65535	1 rev	65535	After restart	Setup	5.9.6																				
Pn207	2	Position Control Function Switch	0000 to 2210	–	0000	After restart	Setup	–																				
	4th digit <input type="checkbox"/> 3rd digit <input type="checkbox"/> 2nd digit <input type="checkbox"/> 1st digit <input type="checkbox"/> n. <input type="checkbox"/> <input type="checkbox"/> <input type="checkbox"/> <input type="checkbox"/>		<table border="1"> <thead> <tr> <th colspan="2">Reserved (Do not change.)</th> <th>Reference Section</th> </tr> </thead> <tbody> <tr> <td>0</td> <td>V-REF not allocated</td> <td rowspan="2">6.9.3</td> </tr> <tr> <td>1</td> <td>Uses V-REF as a speed feedforward input.</td> </tr> </tbody> </table>						Reserved (Do not change.)		Reference Section	0	V-REF not allocated	6.9.3	1	Uses V-REF as a speed feedforward input.												
	Reserved (Do not change.)		Reference Section																									
	0	V-REF not allocated	6.9.3																									
	1	Uses V-REF as a speed feedforward input.																										
			<table border="1"> <thead> <tr> <th colspan="2">Reserved (Do not change.)</th> <th>Reference Section</th> </tr> </thead> <tbody> <tr> <td>0</td> <td>Outputs when the position error absolute value is the same or less than the positioning completed width (Pn522).</td> <td rowspan="3">5.4.6</td> </tr> <tr> <td>1</td> <td>Outputs when the position error absolute value is the same or less than the positioning completed width (Pn522), and the reference after position reference filtering is 0.</td> </tr> <tr> <td>2</td> <td>Outputs when the position error absolute value is the same or less than the positioning completed width (Pn522), and the position reference input is 0.</td> </tr> </tbody> </table>						Reserved (Do not change.)		Reference Section	0	Outputs when the position error absolute value is the same or less than the positioning completed width (Pn522).	5.4.6	1	Outputs when the position error absolute value is the same or less than the positioning completed width (Pn522), and the reference after position reference filtering is 0.	2	Outputs when the position error absolute value is the same or less than the positioning completed width (Pn522), and the position reference input is 0.										
Reserved (Do not change.)		Reference Section																										
0	Outputs when the position error absolute value is the same or less than the positioning completed width (Pn522).	5.4.6																										
1	Outputs when the position error absolute value is the same or less than the positioning completed width (Pn522), and the reference after position reference filtering is 0.																											
2	Outputs when the position error absolute value is the same or less than the positioning completed width (Pn522), and the position reference input is 0.																											
		<table border="1"> <thead> <tr> <th colspan="2">/COIN Output Timing</th> <th>Reference Section</th> </tr> </thead> <tbody> <tr> <td>0</td> <td>Outputs when the position error absolute value is the same or less than the positioning completed width (Pn522).</td> <td rowspan="3">5.4.6</td> </tr> <tr> <td>1</td> <td>Outputs when the position error absolute value is the same or less than the positioning completed width (Pn522), and the reference after position reference filtering is 0.</td> </tr> <tr> <td>2</td> <td>Outputs when the position error absolute value is the same or less than the positioning completed width (Pn522), and the position reference input is 0.</td> </tr> </tbody> </table>						/COIN Output Timing		Reference Section	0	Outputs when the position error absolute value is the same or less than the positioning completed width (Pn522).	5.4.6	1	Outputs when the position error absolute value is the same or less than the positioning completed width (Pn522), and the reference after position reference filtering is 0.	2	Outputs when the position error absolute value is the same or less than the positioning completed width (Pn522), and the position reference input is 0.											
/COIN Output Timing		Reference Section																										
0	Outputs when the position error absolute value is the same or less than the positioning completed width (Pn522).	5.4.6																										
1	Outputs when the position error absolute value is the same or less than the positioning completed width (Pn522), and the reference after position reference filtering is 0.																											
2	Outputs when the position error absolute value is the same or less than the positioning completed width (Pn522), and the position reference input is 0.																											
		<table border="1"> <thead> <tr> <th colspan="2">Reserved (Do not change.)</th> <th>Reference Section</th> </tr> </thead> <tbody> <tr> <td>0</td> <td>Outputs when the position error absolute value is the same or less than the positioning completed width (Pn522).</td> <td rowspan="3">5.4.6</td> </tr> <tr> <td>1</td> <td>Outputs when the position error absolute value is the same or less than the positioning completed width (Pn522), and the reference after position reference filtering is 0.</td> </tr> <tr> <td>2</td> <td>Outputs when the position error absolute value is the same or less than the positioning completed width (Pn522), and the position reference input is 0.</td> </tr> </tbody> </table>						Reserved (Do not change.)		Reference Section	0	Outputs when the position error absolute value is the same or less than the positioning completed width (Pn522).	5.4.6	1	Outputs when the position error absolute value is the same or less than the positioning completed width (Pn522), and the reference after position reference filtering is 0.	2	Outputs when the position error absolute value is the same or less than the positioning completed width (Pn522), and the position reference input is 0.											
Reserved (Do not change.)		Reference Section																										
0	Outputs when the position error absolute value is the same or less than the positioning completed width (Pn522).	5.4.6																										
1	Outputs when the position error absolute value is the same or less than the positioning completed width (Pn522), and the reference after position reference filtering is 0.																											
2	Outputs when the position error absolute value is the same or less than the positioning completed width (Pn522), and the position reference input is 0.																											

(cont'd)

Parameter No.	Size	Name	Setting Range	Units	Factory Setting	When Enabled	Classification	Reference Section	
Pn20A	4	Number of External Scale Pitch	4 to 1048576	1 pitch/rev	32768	After restart	Setup	9.3	
Pn20E	4	Electronic Gear Ratio (Numerator)	1 to 1073741824	1	4	After restart	Setup	5.4.4	
Pn210	4	Electronic Gear Ratio (Denominator)	1 to 1073741824	1	1	After restart	Setup		
Pn212	4	Encoder Output Pulses	16 to 1073741824	1 P/rev	2048	After restart	Setup	5.3.7	
Pn216	2	Position Reference Acceleration/Deceleration Time Constant	0 to 65535	0.1 ms	0	Immediately after the servomotor stops	Setup	5.4.5	
Pn217	2	Average Movement Time of Position Reference	0 to 10000	0.1 ms	0	Immediately after the servomotor stops	Setup		
Pn218	2	Reference Pulse Input Multiplication	1 to 100	1 time	1	Immediately	Setup	5.4.3	
Pn22A	2	Fully-closed Control Selection Switch	0000 to 1003	–	0000	After restart	Setup	–	
	<div style="display: flex; justify-content: space-around; align-items: flex-start;"> <div style="text-align: center;"> 4th digit <input type="checkbox"/> </div> <div style="text-align: center;"> 3rd digit <input type="checkbox"/> </div> <div style="text-align: center;"> 2nd digit <input type="checkbox"/> </div> <div style="text-align: center;"> 1st digit <input type="checkbox"/> </div> </div>								
			Reserved (Do not change.)						
			Reserved (Do not change.)						
		Reserved (Do not change.)							
		Speed Feedback Selection at Fully-closed Control						Reference Section	
		0	Uses motor encoder speed.					9.3.8	
		1	Uses external encoder speed.						
Pn281	2	Encoder Output Resolution	1 to 4096	1 edge/pitch	20	After restart	Setup	9.3.3	
Pn300	2	Speed Reference Input Gain	150 to 3000	0.01V /rated speed	600	Immediately	Setup	5.3.1 5.5.4 6.9.3	
Pn301	2	Internal Set Speed 1	0 to 10000	1 min ⁻¹	100	Immediately	Setup	5.6.1	
Pn302	2	Internal Set Speed 2	0 to 10000	1 min ⁻¹	200	Immediately	Setup		
Pn303	2	Internal Set Speed 3	0 to 10000	1 min ⁻¹	300	Immediately	Setup		
Pn304	2	JOG Speed	0 to 10000	1 min ⁻¹	500	Immediately	Setup	7.3	
Pn305	2	Soft Start Acceleration Time	0 to 10000	1 ms	0	Immediately	Setup	5.3.3	
Pn306	2	Soft Start Deceleration Time	0 to 10000	1 ms	0	Immediately	Setup		
Pn307	2	Speed Reference Filter Time Constant	0 to 65535	0.01 ms	40	Immediately	Setup	5.3.4	

(cont'd)

Parameter No.	Size	Name	Setting Range	Units	Factory Setting	When Enabled	Classification	Reference Section										
Pn310	2	Vibration Detection Switch	0000 to 0002	–	0000	Immediately	Setup	–										
		<div style="display: flex; justify-content: space-around; margin-bottom: 5px;"> 4th digit 3rd digit 2nd digit 1st digit </div> <div style="display: flex; align-items: center;"> n. <div style="display: flex; gap: 10px;"> <input type="checkbox"/> <input type="checkbox"/> <input type="checkbox"/> <input type="checkbox"/> </div> </div>																
		<table border="1" style="width: 100%; border-collapse: collapse;"> <thead> <tr> <th colspan="2">Vibration Detection Selection</th> <th>Reference Section</th> </tr> </thead> <tbody> <tr> <td style="text-align: center;">0</td> <td>Does not detect vibration.</td> <td rowspan="3" style="text-align: center; vertical-align: middle;">7.16</td> </tr> <tr> <td style="text-align: center;">1</td> <td>Outputs warning (A.911) when vibration is detected.</td> </tr> <tr> <td style="text-align: center;">2</td> <td>Outputs alarm (A.520) when vibration is detected.</td> </tr> </tbody> </table>							Vibration Detection Selection		Reference Section	0	Does not detect vibration.	7.16	1	Outputs warning (A.911) when vibration is detected.	2	Outputs alarm (A.520) when vibration is detected.
	Vibration Detection Selection		Reference Section															
	0	Does not detect vibration.	7.16															
	1	Outputs warning (A.911) when vibration is detected.																
	2	Outputs alarm (A.520) when vibration is detected.																
	Reserved (Do not change.)																	
	Reserved (Do not change.)																	
	Reserved (Do not change.)																	
	Reserved (Do not change.)																	
Pn311	2	Vibration Detection Sensibility	50 to 500	1%	100	Immediately	Tuning	7.16										
Pn312	2	Vibration Detection Level	0 to 5000	1 min ⁻¹	50	Immediately	Tuning											
Pn324	2	Moment of Inertia Calculating Start Level	0 to 20000	1%	300	Immediately	Setup	6.3.2										
Pn400	2	Torque Reference Input Gain	10 to 100	0.1 V/ rated torque	30	Immediately	Setup	5.5.1 6.9.2										
Pn401	2	Torque Reference Filter Time Constant	0 to 65535	0.01 ms	100	Immediately	Tuning	6.9.6										
Pn402	2	Forward Torque Limit	0 to 800	1%	800	Immediately	Setup	5.8.1										
Pn403	2	Reverse Torque Limit	0 to 800	1%	800	Immediately	Setup											
Pn404	2	Forward External Torque Limit	0 to 800	1%	100	Immediately	Setup	5.8.2, 5.8.4										
Pn405	2	Reverse External Torque Limit	0 to 800	1%	100	Immediately	Setup											
Pn406	2	Emergency Stop Torque	0 to 800	1%	800	Immediately	Setup	5.2.3										
Pn407	2	Speed Limit during Torque Control	0 to 10000	1 min ⁻¹	10000	Immediately	Setup	5.5.4										

(cont'd)

Parameter No.	Size	Name	Setting Range	Units	Factory Setting	When Enabled	Classification	Reference Section	
Pn408	2	Torque Related Function Switch	0000 to 1111	–	0000	–	–	–	
		<div style="display: flex; justify-content: space-around; align-items: flex-start;"> <div style="text-align: center;"> 4th digit n. <input type="checkbox"/> </div> <div style="text-align: center;"> 3rd digit <input type="checkbox"/> </div> <div style="text-align: center;"> 2nd digit <input type="checkbox"/> </div> <div style="text-align: center;"> 1st digit <input type="checkbox"/> </div> </div>							
			1st Step Notch Filter Selection				When Enabled	Classification	Reference Section
			0	N/A			Immediately	Setup	6.9.6
			1	Uses 1st step notch filter for torque reference.					
			Speed Limit Selection				When Enabled	Classification	Reference Section
			0	Uses the smaller of the maximum motor speed and the value of Pn407 as the speed limit value.			After restart	Setup	5.5.4
			1	Uses the smaller of the overspeed detection speed and the value of Pn407 as the speed limit value.					
			2nd Step Notch Filter Selection				When Enabled	Classification	Reference Section
			0	N/A			Immediately	Setup	6.9.6
			1	Uses 2nd step notch filter for torque reference.					
			Friction Compensation Function Selection				When Enabled	Classification	Reference Section
			0	Disables friction compensation function.			Immediately	Setup	6.8.2
			1	Enables friction compensation function.					
	Pn409	2	1st Notch Filter Frequency	50 to 5000	1 Hz	5000	Immediately	Tuning	6.9.6
Pn40A	2	1st Notch Filter Q Value	50 to 1000	0.01	70	Immediately	Tuning		
Pn40B	2	1st Notch Filter Depth	0 to 1000	0.001	0	Immediately	Tuning		
Pn40C	2	2nd Notch Filter Frequency	50 to 5000	1 Hz	5000	Immediately	Tuning		
Pn40D	2	2nd Notch Filter Q Value	50 to 1000	0.01	70	Immediately	Tuning		
Pn40E	2	2nd Notch Filter Depth	0 to 1000	0.001	0	Immediately	Tuning		
Pn40F	2	2nd Step 2nd Torque Reference Filter Frequency	100 to 5000	1 Hz	5000	Immediately	Tuning		
Pn410	2	2nd Step 2nd Torque Reference Filter Q Value	50 to 100	0.01	50	Immediately	Tuning		
Pn412	2	1st Step 2nd Torque Reference Filter Time Constant	0 to 65535	0.01 ms	100	Immediately	Tuning	6.8.1	
Pn415	2	T-REF Filter Time Constant	0 to 65535	0.01 ms	0	Immediately	Setup	5.5.3	
Pn423	2	Reserved (Do not change.)	–	–	0000	–	–	–	
Pn424	2	Torque Limit at Main Circuit Voltage Drop	0 to 100	1%	50	Immediately	Setup	5.2.7	
Pn425	2	Release Time for Torque Limit at Main Circuit Voltage Drop	0 to 1000	1 ms	100	Immediately	Setup		
Pn456	2	Sweep Torque Reference Amplitude	1 to 800	1%	15	Immediately	Tuning	7.21	

(cont'd)

Parameter No.	Size	Name	Setting Range	Units	Factory Setting	When Enabled	Classification	Reference Section		
Pn460	2	Notch Filter Adjustment Switch	0000 to 0101	–	0101	Immediately	Tuning	6.2.1 6.3.1 6.5.1		
		<div style="display: flex; justify-content: space-around; align-items: flex-start;"> <div style="text-align: center;"> 4th digit n. <input type="checkbox"/> </div> <div style="text-align: center;"> 3rd digit <input type="checkbox"/> </div> <div style="text-align: center;"> 2nd digit <input type="checkbox"/> </div> <div style="text-align: center;"> 1st digit <input type="checkbox"/> </div> </div>								
				Notch Filter Adjustment Selection 1						
				0	Does not adjust 1st step notch filter automatically using utility function.					
				1	Adjust 1st step notch filter automatically using utility function.					
				Reserved (Do not change.)						
				Notch Filter Adjustment Selection 2						
				0	Does not adjust 2nd step notch filter automatically using utility function.					
				1	Adjust 2nd step notch filter automatically using utility function.					
				Reserved (Do not change.)						
Pn501	2	Zero Clamp Level	0 to 10000	1 min ⁻¹	10	Immediately	Setup	5.3.5		
Pn502	2	Rotation Detection Level	1 to 10000	1 min ⁻¹	20	Immediately	Setup	5.10.3		
Pn503	2	Speed Coincidence Signal Output Width	0 to 100	1 min ⁻¹	10	Immediately	Setup	5.3.8		
Pn506	2	Brake Reference - Servo OFF Delay Time	0 to 50	10 ms	0	Immediately	Setup	5.2.4		
Pn507	2	Brake Reference Output Speed Level	0 to 10000	1 min ⁻¹	100	Immediately	Setup			
Pn508	2	Waiting Time for Brake Signal When Motor Running	10 to 100	10 ms	50	Immediately	Setup			
Pn509	2	Instantaneous Power Cut Hold time	20 to 1000	1 ms	20	Immediately	Setup	5.2.6		

(cont'd)

Parameter No.	Size	Name	Setting Range	Units	Factory Setting	When Enabled	Classification	Reference Section	
Pn50A	2	Input Signal Selection 1	0000 to FFF1	–	2100	After restart	Setup	–	
	<div style="display: flex; justify-content: space-around; align-items: flex-start;"> <div style="text-align: center;"> <p>4th digit</p> <input type="checkbox"/> </div> <div style="text-align: center;"> <p>3rd digit</p> <input type="checkbox"/> </div> <div style="text-align: center;"> <p>2nd digit</p> <input type="checkbox"/> </div> <div style="text-align: center;"> <p>1st digit</p> <input type="checkbox"/> </div> </div> <p>n.</p>								
	Input Signal Allocation Mode							Reference Section	
	0							Uses the sequence input signal terminals with the factory-set allocations.	3.3.1
	1							Changes the sequence input signal allocation for each signal.	
	Servo ON (/S-ON) Signal Mapping Signal Polarity: Normal; Servomotor power ON when ON (closed) Signal Polarity: Reverse; Servomotor power OFF when OFF (open)							Reference Section	
	0							Active when CN1-40 input signal is ON (closed).	5.2.1
	1							Active when CN1-41 input signal is ON (closed).	
	2							Active when CN1-42 input signal is ON (closed).	
	3							Active when CN1-43 input signal is ON (closed).	
	4							Active when CN1-44 input signal is ON (closed).	
	5							Active when CN1-45 input signal is ON (closed).	
	6							Active when CN1-46 input signal is ON (closed).	
	7							Always active (fixed).	
	8							Not active (fixed).	
9							Active when CN1-40 input signal is OFF (open).		
A							Active when CN1-41 input signal is OFF (open).		
B							Active when CN1-42 input signal is OFF (open).		
C							Active when CN1-43 input signal is OFF (open).		
D							Active when CN1-44 input signal is OFF (open).		
E							Active when CN1-45 input signal is OFF (open).		
F							Active when CN1-46 input signal is OFF (open).		
/P-CON Signal Mapping (P control when ON (closed))							Reference Section		
0 to F							Same as Servo ON Signal (/S-ON) Mapping.	6.9.4	
P-OT Signal Mapping (Forward run prohibited when OFF (open))							Reference Section		
0							Forward run allowed when CN1-40 input signal is ON (closed).	5.2.3	
1							Forward run allowed when CN1-41 input signal is ON (closed).		
2							Forward run allowed when CN1-42 input signal is ON (closed).		
3							Forward run allowed when CN1-43 input signal is ON (closed).		
4							Forward run allowed when CN1-44 input signal is ON (closed).		
5							Forward run allowed when CN1-45 input signal is ON (closed).		
6							Forward run allowed when CN1-46 input signal is ON (closed).		
7							Forward run prohibited.		
8							Forward run allowed.		
9							Forward run allowed when CN1-40 input signal is OFF (open).		
A							Forward run allowed when CN1-41 input signal is OFF (open).		
B							Forward run allowed when CN1-42 input signal is OFF (open).		
C							Forward run allowed when CN1-43 input signal is OFF (open).		
D							Forward run allowed when CN1-44 input signal is OFF (open).		
E							Forward run allowed when CN1-45 input signal is OFF (open).		
F							Forward run allowed when CN1-46 input signal is OFF (open).		

(cont'd)

Parameter No.	Size	Name	Setting Range	Units	Factory Setting	When Enabled	Classification	Reference Section																																				
Pn50B	2	Input Signal Selection 2	0000 to FFFF	–	6543	After restart	Setup	–																																				
	<div style="display: flex; justify-content: space-around; align-items: flex-start;"> <div style="text-align: center;"> <p>4th digit</p> <p>n. <input type="checkbox"/></p> </div> <div style="text-align: center;"> <p>3rd digit</p> <p><input type="checkbox"/></p> </div> <div style="text-align: center;"> <p>2nd digit</p> <p><input type="checkbox"/></p> </div> <div style="text-align: center;"> <p>1st digit</p> <p><input type="checkbox"/></p> </div> </div>																																											
	<table border="1" style="width: 100%; border-collapse: collapse;"> <thead> <tr> <th colspan="2">N-OT Signal Mapping (Reverse run prohibited when OFF (open))</th> <th>Reference Section</th> </tr> </thead> <tbody> <tr><td>0</td><td>Reverse run allowed when CN1-40 input signal is ON (closed).</td><td rowspan="16" style="text-align: center; vertical-align: middle;">5.2.3</td></tr> <tr><td>1</td><td>Reverse run allowed when CN1-41 input signal is ON (closed).</td></tr> <tr><td>2</td><td>Reverse run allowed when CN1-42 input signal is ON (closed).</td></tr> <tr><td>3</td><td>Reverse run allowed when CN1-43 input signal is ON (closed).</td></tr> <tr><td>4</td><td>Reverse run allowed when CN1-44 input signal is ON (closed).</td></tr> <tr><td>5</td><td>Reverse run allowed when CN1-45 input signal is ON (closed).</td></tr> <tr><td>6</td><td>Reverse run allowed when CN1-46 input signal is ON (closed).</td></tr> <tr><td>7</td><td>Reverse run prohibited.</td></tr> <tr><td>8</td><td>Reverse run allowed.</td></tr> <tr><td>9</td><td>Reverse run allowed when CN1-40 input signal is OFF (open).</td></tr> <tr><td>A</td><td>Reverse run allowed when CN1-41 input signal is OFF (open).</td></tr> <tr><td>B</td><td>Reverse run allowed when CN1-42 input signal is OFF (open).</td></tr> <tr><td>C</td><td>Reverse run allowed when CN1-43 input signal is OFF (open).</td></tr> <tr><td>D</td><td>Reverse run allowed when CN1-44 input signal is OFF (open).</td></tr> <tr><td>E</td><td>Reverse run allowed when CN1-45 input signal is OFF (open).</td></tr> <tr><td>F</td><td>Reverse run allowed when CN1-46 input signal is OFF (open).</td></tr> </tbody> </table>								N-OT Signal Mapping (Reverse run prohibited when OFF (open))		Reference Section	0	Reverse run allowed when CN1-40 input signal is ON (closed).	5.2.3	1	Reverse run allowed when CN1-41 input signal is ON (closed).	2	Reverse run allowed when CN1-42 input signal is ON (closed).	3	Reverse run allowed when CN1-43 input signal is ON (closed).	4	Reverse run allowed when CN1-44 input signal is ON (closed).	5	Reverse run allowed when CN1-45 input signal is ON (closed).	6	Reverse run allowed when CN1-46 input signal is ON (closed).	7	Reverse run prohibited.	8	Reverse run allowed.	9	Reverse run allowed when CN1-40 input signal is OFF (open).	A	Reverse run allowed when CN1-41 input signal is OFF (open).	B	Reverse run allowed when CN1-42 input signal is OFF (open).	C	Reverse run allowed when CN1-43 input signal is OFF (open).	D	Reverse run allowed when CN1-44 input signal is OFF (open).	E	Reverse run allowed when CN1-45 input signal is OFF (open).	F	Reverse run allowed when CN1-46 input signal is OFF (open).
	N-OT Signal Mapping (Reverse run prohibited when OFF (open))		Reference Section																																									
	0	Reverse run allowed when CN1-40 input signal is ON (closed).	5.2.3																																									
	1	Reverse run allowed when CN1-41 input signal is ON (closed).																																										
	2	Reverse run allowed when CN1-42 input signal is ON (closed).																																										
	3	Reverse run allowed when CN1-43 input signal is ON (closed).																																										
	4	Reverse run allowed when CN1-44 input signal is ON (closed).																																										
	5	Reverse run allowed when CN1-45 input signal is ON (closed).																																										
6	Reverse run allowed when CN1-46 input signal is ON (closed).																																											
7	Reverse run prohibited.																																											
8	Reverse run allowed.																																											
9	Reverse run allowed when CN1-40 input signal is OFF (open).																																											
A	Reverse run allowed when CN1-41 input signal is OFF (open).																																											
B	Reverse run allowed when CN1-42 input signal is OFF (open).																																											
C	Reverse run allowed when CN1-43 input signal is OFF (open).																																											
D	Reverse run allowed when CN1-44 input signal is OFF (open).																																											
E	Reverse run allowed when CN1-45 input signal is OFF (open).																																											
F	Reverse run allowed when CN1-46 input signal is OFF (open).																																											
<table border="1" style="width: 100%; border-collapse: collapse;"> <thead> <tr> <th colspan="2">/ALM-RST Signal Mapping (Alarm reset when OFF (open) to ON (closed))</th> <th>Reference Section</th> </tr> </thead> <tbody> <tr><td>0</td><td>Active on the falling edge of CN1-40 input signal.</td><td rowspan="16" style="text-align: center; vertical-align: middle;">5.10.1</td></tr> <tr><td>1</td><td>Active on the falling edge of CN1-41 input signal.</td></tr> <tr><td>2</td><td>Active on the falling edge of CN1-42 input signal.</td></tr> <tr><td>3</td><td>Active on the falling edge of CN1-43 input signal.</td></tr> <tr><td>4</td><td>Active on the falling edge of CN1-44 input signal.</td></tr> <tr><td>5</td><td>Active on the falling edge of CN1-45 input signal.</td></tr> <tr><td>6</td><td>Active on the falling edge of CN1-46 input signal.</td></tr> <tr><td>7</td><td>Reserved (Do not change.)</td></tr> <tr><td>8</td><td>Not active (fixed).</td></tr> <tr><td>9</td><td>Active on the rising edge of CN1-40 input signal.</td></tr> <tr><td>A</td><td>Active on the rising edge of CN1-41 input signal.</td></tr> <tr><td>B</td><td>Active on the rising edge of CN1-42 input signal.</td></tr> <tr><td>C</td><td>Active on the rising edge of CN1-43 input signal.</td></tr> <tr><td>D</td><td>Active on the rising edge of CN1-44 input signal.</td></tr> <tr><td>E</td><td>Active on the rising edge of CN1-45 input signal.</td></tr> <tr><td>F</td><td>Active on the rising edge of CN1-46 input signal.</td></tr> </tbody> </table>								/ALM-RST Signal Mapping (Alarm reset when OFF (open) to ON (closed))		Reference Section	0	Active on the falling edge of CN1-40 input signal.	5.10.1	1	Active on the falling edge of CN1-41 input signal.	2	Active on the falling edge of CN1-42 input signal.	3	Active on the falling edge of CN1-43 input signal.	4	Active on the falling edge of CN1-44 input signal.	5	Active on the falling edge of CN1-45 input signal.	6	Active on the falling edge of CN1-46 input signal.	7	Reserved (Do not change.)	8	Not active (fixed).	9	Active on the rising edge of CN1-40 input signal.	A	Active on the rising edge of CN1-41 input signal.	B	Active on the rising edge of CN1-42 input signal.	C	Active on the rising edge of CN1-43 input signal.	D	Active on the rising edge of CN1-44 input signal.	E	Active on the rising edge of CN1-45 input signal.	F	Active on the rising edge of CN1-46 input signal.	
/ALM-RST Signal Mapping (Alarm reset when OFF (open) to ON (closed))		Reference Section																																										
0	Active on the falling edge of CN1-40 input signal.	5.10.1																																										
1	Active on the falling edge of CN1-41 input signal.																																											
2	Active on the falling edge of CN1-42 input signal.																																											
3	Active on the falling edge of CN1-43 input signal.																																											
4	Active on the falling edge of CN1-44 input signal.																																											
5	Active on the falling edge of CN1-45 input signal.																																											
6	Active on the falling edge of CN1-46 input signal.																																											
7	Reserved (Do not change.)																																											
8	Not active (fixed).																																											
9	Active on the rising edge of CN1-40 input signal.																																											
A	Active on the rising edge of CN1-41 input signal.																																											
B	Active on the rising edge of CN1-42 input signal.																																											
C	Active on the rising edge of CN1-43 input signal.																																											
D	Active on the rising edge of CN1-44 input signal.																																											
E	Active on the rising edge of CN1-45 input signal.																																											
F	Active on the rising edge of CN1-46 input signal.																																											
<table border="1" style="width: 100%; border-collapse: collapse;"> <thead> <tr> <th colspan="2">/P-CL Signal Mapping (Torque Limit when ON (closed))</th> <th>Reference Section</th> </tr> </thead> <tbody> <tr> <td>0 to F</td> <td>Same as Servo ON Signal (/S-ON) Mapping.</td> <td style="text-align: center;">5.8.2</td> </tr> </tbody> </table>								/P-CL Signal Mapping (Torque Limit when ON (closed))		Reference Section	0 to F	Same as Servo ON Signal (/S-ON) Mapping.	5.8.2																															
/P-CL Signal Mapping (Torque Limit when ON (closed))		Reference Section																																										
0 to F	Same as Servo ON Signal (/S-ON) Mapping.	5.8.2																																										
<table border="1" style="width: 100%; border-collapse: collapse;"> <thead> <tr> <th colspan="2">/N-CL Signal Mapping (Torque Limit when ON (closed))</th> <th>Reference Section</th> </tr> </thead> <tbody> <tr> <td>0 to F</td> <td>Same as Servo ON Signal (/S-ON) Mapping.</td> <td style="text-align: center;">5.8.2</td> </tr> </tbody> </table>								/N-CL Signal Mapping (Torque Limit when ON (closed))		Reference Section	0 to F	Same as Servo ON Signal (/S-ON) Mapping.	5.8.2																															
/N-CL Signal Mapping (Torque Limit when ON (closed))		Reference Section																																										
0 to F	Same as Servo ON Signal (/S-ON) Mapping.	5.8.2																																										

(cont'd)

Parameter No.	Size	Name	Setting Range	Units	Factory Setting	When Enabled	Classification	Reference Section																																				
Pn50C	2	Input Signal Selection 3	0000 to FFFF	–	8888	After restart	Setup	–																																				
	4th digit <input type="checkbox"/> 3rd digit <input type="checkbox"/> 2nd digit <input type="checkbox"/> 1st digit <input type="checkbox"/> n. <input type="checkbox"/>		<table border="1"> <thead> <tr> <th colspan="2">/SPD-D Signal Mapping (Refer to 5.6 Internal Set Speed Control.)</th> <th>Reference Section</th> </tr> </thead> <tbody> <tr><td>0</td><td>Active when CN1-40 input signal is ON (closed).</td><td rowspan="15">5.6.1</td></tr> <tr><td>1</td><td>Active when CN1-41 input signal is ON (closed).</td></tr> <tr><td>2</td><td>Active when CN1-42 input signal is ON (closed).</td></tr> <tr><td>3</td><td>Active when CN1-43 input signal is ON (closed).</td></tr> <tr><td>4</td><td>Active when CN1-44 input signal is ON (closed).</td></tr> <tr><td>5</td><td>Active when CN1-45 input signal is ON (closed).</td></tr> <tr><td>6</td><td>Active when CN1-46 input signal is ON (closed).</td></tr> <tr><td>7</td><td>Reserved (Do not change.)</td></tr> <tr><td>8</td><td>Not active (fixed).</td></tr> <tr><td>9</td><td>Active when CN1-40 input signal is OFF (open).</td></tr> <tr><td>A</td><td>Active when CN1-41 input signal is OFF (open).</td></tr> <tr><td>B</td><td>Active when CN1-42 input signal is OFF (open).</td></tr> <tr><td>C</td><td>Active when CN1-43 input signal is OFF (open).</td></tr> <tr><td>D</td><td>Active when CN1-44 input signal is OFF (open).</td></tr> <tr><td>E</td><td>Active when CN1-45 input signal is OFF (open).</td></tr> <tr><td>F</td><td>Active when CN1-46 input signal is OFF (open).</td></tr> </tbody> </table>						/SPD-D Signal Mapping (Refer to 5.6 Internal Set Speed Control.)		Reference Section	0	Active when CN1-40 input signal is ON (closed).	5.6.1	1	Active when CN1-41 input signal is ON (closed).	2	Active when CN1-42 input signal is ON (closed).	3	Active when CN1-43 input signal is ON (closed).	4	Active when CN1-44 input signal is ON (closed).	5	Active when CN1-45 input signal is ON (closed).	6	Active when CN1-46 input signal is ON (closed).	7	Reserved (Do not change.)	8	Not active (fixed).	9	Active when CN1-40 input signal is OFF (open).	A	Active when CN1-41 input signal is OFF (open).	B	Active when CN1-42 input signal is OFF (open).	C	Active when CN1-43 input signal is OFF (open).	D	Active when CN1-44 input signal is OFF (open).	E	Active when CN1-45 input signal is OFF (open).	F	Active when CN1-46 input signal is OFF (open).
	/SPD-D Signal Mapping (Refer to 5.6 Internal Set Speed Control.)		Reference Section																																									
	0	Active when CN1-40 input signal is ON (closed).	5.6.1																																									
	1	Active when CN1-41 input signal is ON (closed).																																										
	2	Active when CN1-42 input signal is ON (closed).																																										
	3	Active when CN1-43 input signal is ON (closed).																																										
	4	Active when CN1-44 input signal is ON (closed).																																										
	5	Active when CN1-45 input signal is ON (closed).																																										
	6	Active when CN1-46 input signal is ON (closed).																																										
	7	Reserved (Do not change.)																																										
	8	Not active (fixed).																																										
	9	Active when CN1-40 input signal is OFF (open).																																										
	A	Active when CN1-41 input signal is OFF (open).																																										
	B	Active when CN1-42 input signal is OFF (open).																																										
C	Active when CN1-43 input signal is OFF (open).																																											
D	Active when CN1-44 input signal is OFF (open).																																											
E	Active when CN1-45 input signal is OFF (open).																																											
F	Active when CN1-46 input signal is OFF (open).																																											
		<table border="1"> <thead> <tr> <th colspan="2">/SPD-A Signal Mapping (Refer to 5.6 Internal Set Speed Control.)</th> <th>Reference Section</th> </tr> </thead> <tbody> <tr> <td>0 to F</td> <td>Same as /SPD-D Signal Mapping.</td> <td>5.6.1</td> </tr> </tbody> </table>						/SPD-A Signal Mapping (Refer to 5.6 Internal Set Speed Control.)		Reference Section	0 to F	Same as /SPD-D Signal Mapping.	5.6.1																															
/SPD-A Signal Mapping (Refer to 5.6 Internal Set Speed Control.)		Reference Section																																										
0 to F	Same as /SPD-D Signal Mapping.	5.6.1																																										
		<table border="1"> <thead> <tr> <th colspan="2">/SPD-B Signal Mapping (Refer to 5.6 Internal Set Speed Control.)</th> <th>Reference Section</th> </tr> </thead> <tbody> <tr> <td>0 to F</td> <td>Same as /SPD-D Signal Mapping.</td> <td>5.6.1</td> </tr> </tbody> </table>						/SPD-B Signal Mapping (Refer to 5.6 Internal Set Speed Control.)		Reference Section	0 to F	Same as /SPD-D Signal Mapping.	5.6.1																															
/SPD-B Signal Mapping (Refer to 5.6 Internal Set Speed Control.)		Reference Section																																										
0 to F	Same as /SPD-D Signal Mapping.	5.6.1																																										
		<table border="1"> <thead> <tr> <th colspan="2">/C-SEL Signal Mapping (Control method change when ON (closed))</th> <th>Reference Section</th> </tr> </thead> <tbody> <tr> <td>0 to F</td> <td>Same as /SPD-D Signal Mapping.</td> <td>5.7.1</td> </tr> </tbody> </table>						/C-SEL Signal Mapping (Control method change when ON (closed))		Reference Section	0 to F	Same as /SPD-D Signal Mapping.	5.7.1																															
/C-SEL Signal Mapping (Control method change when ON (closed))		Reference Section																																										
0 to F	Same as /SPD-D Signal Mapping.	5.7.1																																										

(cont'd)

Parameter No.	Size	Name	Setting Range	Units	Factory Setting	When Enabled	Classification	Reference Section		
Pn50D	2	Input Signal Selection 4	0000 to FFFF	–	8888	After restart	Setup	–		
	<div style="display: flex; justify-content: space-around; align-items: flex-start;"> <div style="text-align: center;"> 4th digit <input type="checkbox"/> </div> <div style="text-align: center;"> 3rd digit <input type="checkbox"/> </div> <div style="text-align: center;"> 2nd digit <input type="checkbox"/> </div> <div style="text-align: center;"> 1st digit <input type="checkbox"/> </div> </div>									
			/ZCLAMP Signal Mapping (Zero clamp when ON (closed))						Reference Section	
			0 Active when CN1-40 input signal is ON (closed).						5.3.5	
			1 Active when CN1-41 input signal is ON (closed).							
			2 Active when CN1-42 input signal is ON (closed).							
			3 Active when CN1-43 input signal is ON (closed).							
			4 Active when CN1-44 input signal is ON (closed).							
			5 Active when CN1-45 input signal is ON (closed).							
			6 Active when CN1-46 input signal is ON (closed).							
			7 Always active (fixed).							
			8 Not active (fixed).							
			9 Active when CN1-40 input signal is OFF (open).							
			A Active when CN1-41 input signal is OFF (open).							
			B Active when CN1-42 input signal is OFF (open).							
		C Active when CN1-43 input signal is OFF (open).								
		D Active when CN1-44 input signal is OFF (open).								
		E Active when CN1-45 input signal is OFF (open).								
		F Active when CN1-46 input signal is OFF (open).								
		/INHIBIT Signal Mapping (Reference pulse inhibit when ON (closed))						Reference Section		
		0 to F Same as /ZCLAMP Signal Mapping.						5.4.8		
		/G-SEL1 Signal Mapping (Gain change when ON (closed))						Reference Section		
		0 to F Same as /ZCLAMP Signal Mapping.						6.9.6		
		Reserved (Do not change.)								
Pn50E	2	Output Signal Selection 1	0000 to 3333	–	3211	After restart	Setup	–		
	<div style="display: flex; justify-content: space-around; align-items: flex-start;"> <div style="text-align: center;"> 4th digit <input type="checkbox"/> </div> <div style="text-align: center;"> 3rd digit <input type="checkbox"/> </div> <div style="text-align: center;"> 2nd digit <input type="checkbox"/> </div> <div style="text-align: center;"> 1st digit <input type="checkbox"/> </div> </div>									
			Positioning Completion Signal Mapping (/COIN)						Reference Section	
			0 Disabled (the above signal is not used.)						5.4.6	
			1 Outputs the signal from CN1-25, -26 output terminal.							
			2 Outputs the signal from CN1-27, -28 output terminal.							
			3 Outputs the signal from CN1-29, -30 output terminal.							
			Speed Coincidence Detection Signal Mapping (/V-CMP)						Reference Section	
			0 to 3 Same as /COIN Signal Mapping.						5.3.8	
			Servomotor Rotation Detection Signal Mapping (/TGON)						Reference Section	
		0 to 3 Same as /COIN Signal Mapping.						5.10.3		
		Servo Ready Signal Mapping (/S-RDY)						Reference Section		
		0 to 3 Same as /COIN Signal Mapping.						5.10.4		

(cont'd)

Parameter No.	Size	Name	Setting Range	Units	Factory Setting	When Enabled	Classification	Reference Section	
Pn50F	2	Output Signal Selection 2	0000 to 3333	–	0000	After restart	Setup	–	
	<div style="display: flex; justify-content: space-around;"> 4th digit 3rd digit 2nd digit 1st digit </div> <div style="display: flex; justify-content: space-around;"> <input type="checkbox"/> <input type="checkbox"/> <input type="checkbox"/> <input type="checkbox"/> </div>								
			Torque Limit Detection Signal Mapping (/CLT)						Reference Section
			0	Disabled (the above signal is not used.)					5.8.5
			1	Outputs the signal from CN1-25, -26 output terminal.					
			2	Outputs the signal from CN1-27, -28 output terminal.					
			3	Outputs the signal from CN1-29, -30 output terminal.					
			Speed Limit Detection Signal Mapping (/VLT)						Reference Section
			0 to 3	Same as /CLT Signal Mapping.					5.5.4
			Brake Signal Mapping (/BK)						Reference Section
			0 to 3	Same as /CLT Signal Mapping.					5.2.4
			Warning Signal Mapping (/WARN)						Reference Section
			0 to 3	Same as /CLT Signal Mapping.					5.10.2
	Pn510	2	Output Signal Selection 3	0000 to 0333	–	0000	After restart	Setup	–
		<div style="display: flex; justify-content: space-around;"> 4th digit 3rd digit 2nd digit 1st digit </div> <div style="display: flex; justify-content: space-around;"> <input type="checkbox"/> <input type="checkbox"/> <input type="checkbox"/> <input type="checkbox"/> </div>							
		Near Signal Mapping (/NEAR)						Reference Section	
		0	Disabled (the above signal is not used.)					5.4.7	
		1	Outputs the signal from CN1-25, -26 terminal.						
		2	Outputs the signal from CN1-27, -28 terminal.						
		3	Outputs the signal from CN1-29, -30 terminal.						
		Reserved (Do not change.)							
		Reference Pulse Input Multiplication Switching Output Signal Mapping (/PSELA)						Reference Section	
		0 to 3	Same as /NEAR Signal Mapping.					5.4.3	
		Reserved (Do not change.)							
Pn511	2	Input Signal Selection 5	0000 to FFFF	–	8888	After restart	Setup	–	
	<div style="display: flex; justify-content: space-around;"> 4th digit 3rd digit 2nd digit 1st digit </div> <div style="display: flex; justify-content: space-around;"> <input type="checkbox"/> <input type="checkbox"/> <input type="checkbox"/> <input type="checkbox"/> </div>								
			Reserved (Do not change.)						
			Reserved (Do not change.)						
			Reserved (Do not change.)						

(cont'd)

Parameter No.	Size	Name	Setting Range	Units	Factory Setting	When Enabled	Classification	Reference Section												
Pn512	2	Output Signal Inverse Setting	0000 to 0111	–	0000	After restart	Setup	3.3.2												
	<p>4th digit 3rd digit 2nd digit 1st digit</p> <p>n. <input type="checkbox"/> <input type="checkbox"/> <input type="checkbox"/> <input type="checkbox"/></p> <p>Output Signal Inversion for CN1-25 or -26 Terminal</p> <table border="1"> <tr><td>0</td><td>Does not invert outputs.</td></tr> <tr><td>1</td><td>Inverts outputs.</td></tr> </table> <p>Output Signal Inversion for CN1-27 or -28 Terminal</p> <table border="1"> <tr><td>0</td><td>Does not invert outputs.</td></tr> <tr><td>1</td><td>Inverts outputs.</td></tr> </table> <p>Output Signal Inversion for CN1-29 or -30 Terminal</p> <table border="1"> <tr><td>0</td><td>Does not invert outputs.</td></tr> <tr><td>1</td><td>Inverts outputs.</td></tr> </table> <p>Reserved (Do not change.)</p>								0	Does not invert outputs.	1	Inverts outputs.	0	Does not invert outputs.	1	Inverts outputs.	0	Does not invert outputs.	1	Inverts outputs.
	0	Does not invert outputs.																		
	1	Inverts outputs.																		
	0	Does not invert outputs.																		
1	Inverts outputs.																			
0	Does not invert outputs.																			
1	Inverts outputs.																			
Pn513	2	Output Signal Selection 4	0000 to 0333	–	0000	After restart	Setup	–												
	<p>4th digit 3rd digit 2nd digit 1st digit</p> <p>n. <input type="checkbox"/> <input type="checkbox"/> <input type="checkbox"/> <input type="checkbox"/></p> <p>Reserved (Do not change.)</p> <p>Reserved (Do not change.)</p> <p>Reserved (Do not change.)</p> <p>Reserved (Do not change.)</p>																			
	Reserved (Do not change.)																			
	Reserved (Do not change.)																			

(cont'd)

Parameter No.	Size	Name	Setting Range	Units	Factory Setting	When Enabled	Classification	Reference Section		
Pn515	2	Input Signal Selection 6	0000 to FFFF	–	8888	After restart	Setup	–		
		<div style="display: flex; justify-content: space-around; align-items: flex-start;"> <div style="text-align: center;"> 4th digit n. <input type="checkbox"/> </div> <div style="text-align: center;"> 3rd digit <input type="checkbox"/> </div> <div style="text-align: center;"> 2nd digit <input type="checkbox"/> </div> <div style="text-align: center;"> 1st digit <input type="checkbox"/> </div> </div>	Reserved (Do not change.)							
			Reference Pulse Input Multiplication Switching Input Signal Mapping (/PSEL)						Reference Section	
			0	Active when CN1-40 input signal is ON (closed).						5.4.3
			1	Active when CN1-41 input signal is ON (closed).						
			2	Active when CN1-42 input signal is ON (closed).						
			3	Active when CN1-43 input signal is ON (closed).						
			4	Active when CN1-44 input signal is ON (closed).						
			5	Active when CN1-45 input signal is ON (closed).						
			6	Active when CN1-46 input signal is ON (closed).						
			7	Always active (fixed).						
			8	Not active (fixed).						
			9	Active when CN1-40 input signal is OFF (open).						
			A	Active when CN1-41 input signal is OFF (open).						
		B	Active when CN1-42 input signal is OFF (open).							
		C	Active when CN1-43 input signal is OFF (open).							
		D	Active when CN1-44 input signal is OFF (open).							
		E	Active when CN1-45 input signal is OFF (open).							
		F	Active when CN1-46 input signal is OFF (open).							
			Reserved (Do not change.)							
			Reserved (Do not change.)							
Pn517	2	Reserved (Do not change.)	–	–	0000	–	–	–		
Pn51B	4	Excessive Error Level between Servomotor and Load Positions	0 to 1073741824	1 reference unit	1000	Immediately	Setup	9.3.6		
Pn51E	2	Excessive Position Error Warning Level	10 to 100	1%	100	Immediately	Setup	10.2.1		
Pn520	4	Excessive Position Error Alarm Level	1 to 1073741823	1 reference unit	5242880	Immediately	Setup	6.1.4 10.1.1		
Pn522	4	Positioning Completed Width	0 to 1073741824	1 reference unit	7	Immediately	Setup	5.4.6		
Pn524	4	NEAR Signal Width	1 to 1073741824	1 reference unit	1073741824	Immediately	Setup	5.4.7		
Pn526	4	Excessive Position Error Alarm Level at Servo ON	1 to 1073741823	1 reference unit	5242880	Immediately	Setup	6.1.4		
Pn528	2	Excessive Position Error Warning Level at Servo ON	10 to 100	1%	100	Immediately	Setup			
Pn529	2	Speed Limit Level at Servo ON	0 to 10000	1 min ⁻¹	10000	Immediately	Setup			
Pn52A	2	Multiplier per One Fully-closed Rotation	0 to 100	1%	20	Immediately	Tuning	9.3.6		
Pn52B	2	Overload Warning Level	1 to 100	1%	20	Immediately	Setup	5.2.8		
Pn52C	2	Derating of Base Current at Detecting Overload of Motor	10 to 100	1%	100	After restart	Setup			

(cont'd)

Parameter No.	Size	Name	Setting Range	Units	Factory Setting	When Enabled	Classification	Reference Section																					
Pn52D	2	Reserved (Do not change.)	–	–	50	–	–	–																					
Pn52F	2	Monitor Display at Power ON	0000 to 0FFF	–	0FFF	Immediately	Setup	8.7																					
Pn530	2	Program JOG Operation Related Switch	0000 to 0005	–	0000	Immediately	Setup	7.5																					
		<div style="display: flex; align-items: center;"> <div style="margin-right: 10px;"> 4th digit n. <input type="checkbox"/> </div> <div style="margin-right: 10px;"> 3rd digit <input type="checkbox"/> </div> <div style="margin-right: 10px;"> 2nd digit <input type="checkbox"/> </div> <div style="margin-right: 10px;"> 1st digit <input type="checkbox"/> </div> </div> <table border="1" style="margin-left: 20px; width: 100%;"> <thead> <tr> <th colspan="2">Program JOG Operation Switch</th> </tr> </thead> <tbody> <tr> <td>0</td> <td>(Waiting time Pn535 → Forward movement Pn531) × Number of movements Pn536</td> </tr> <tr> <td>1</td> <td>(Waiting time Pn535 → Reverse movement Pn531) × Number of movements Pn536</td> </tr> <tr> <td>2</td> <td>(Waiting time Pn535 → Forward movement Pn531) × Number of movements Pn536 (Waiting time Pn535 → Reverse movement Pn531) × Number of movements Pn536</td> </tr> <tr> <td>3</td> <td>(Waiting time Pn535 → Reverse movement Pn531) × Number of movements Pn536 (Waiting time Pn535 → Forward movement Pn531) × Number of movements Pn536</td> </tr> <tr> <td>4</td> <td>(Waiting time Pn535 → Forward movement Pn531 → Waiting time Pn535 → Reverse movement Pn531) × Number of movements Pn536</td> </tr> <tr> <td>5</td> <td>(Waiting time Pn535 → Reverse movement Pn531 → Waiting time Pn535 → Forward movement Pn531) × Number of movements Pn536</td> </tr> <tr> <td colspan="2">Reserved (Do not change.)</td> </tr> <tr> <td colspan="2">Reserved (Do not change.)</td> </tr> <tr> <td colspan="2">Reserved (Do not change.)</td> </tr> </tbody> </table>								Program JOG Operation Switch		0	(Waiting time Pn535 → Forward movement Pn531) × Number of movements Pn536	1	(Waiting time Pn535 → Reverse movement Pn531) × Number of movements Pn536	2	(Waiting time Pn535 → Forward movement Pn531) × Number of movements Pn536 (Waiting time Pn535 → Reverse movement Pn531) × Number of movements Pn536	3	(Waiting time Pn535 → Reverse movement Pn531) × Number of movements Pn536 (Waiting time Pn535 → Forward movement Pn531) × Number of movements Pn536	4	(Waiting time Pn535 → Forward movement Pn531 → Waiting time Pn535 → Reverse movement Pn531) × Number of movements Pn536	5	(Waiting time Pn535 → Reverse movement Pn531 → Waiting time Pn535 → Forward movement Pn531) × Number of movements Pn536	Reserved (Do not change.)		Reserved (Do not change.)		Reserved (Do not change.)	
		Program JOG Operation Switch																											
		0	(Waiting time Pn535 → Forward movement Pn531) × Number of movements Pn536																										
		1	(Waiting time Pn535 → Reverse movement Pn531) × Number of movements Pn536																										
		2	(Waiting time Pn535 → Forward movement Pn531) × Number of movements Pn536 (Waiting time Pn535 → Reverse movement Pn531) × Number of movements Pn536																										
		3	(Waiting time Pn535 → Reverse movement Pn531) × Number of movements Pn536 (Waiting time Pn535 → Forward movement Pn531) × Number of movements Pn536																										
		4	(Waiting time Pn535 → Forward movement Pn531 → Waiting time Pn535 → Reverse movement Pn531) × Number of movements Pn536																										
		5	(Waiting time Pn535 → Reverse movement Pn531 → Waiting time Pn535 → Forward movement Pn531) × Number of movements Pn536																										
		Reserved (Do not change.)																											
Reserved (Do not change.)																													
Reserved (Do not change.)																													
Pn531	4	Program JOG Movement Distance	1 to 1073741824	1 reference unit	32768	Immediately	Setup	7.5																					
Pn533	2	Program JOG Movement Speed	1 to 10000	1 min ⁻¹	500	Immediately	Setup																						
Pn534	2	Program JOG Acceleration/Deceleration Time	2 to 10000	1 ms	100	Immediately	Setup																						
Pn535	2	Program JOG Waiting Time	0 to 10000	1 ms	100	Immediately	Setup																						
Pn536	2	Number of Times of Program JOG Movement	0 to 1000	1 time	1	Immediately	Setup																						
Pn550	2	Analog Monitor 1 Offset Voltage	-10000 to 10000	0.1 V	0	Immediately	Setup	6.1.3																					
Pn551	2	Analog Monitor 2 Offset Voltage	-10000 to 10000	0.1 V	0	Immediately	Setup																						
Pn552	2	Analog Monitor Magnification (×1)	-10000 to 10000	×0.01	100	Immediately	Setup																						
Pn553	2	Analog Monitor Magnification (×2)	-10000 to 10000	×0.01	100	Immediately	Setup																						
Pn560	2	Remained Vibration Detection Width	1 to 3000	0.1%	400	Immediately	Setup	6.7.1																					
Pn561	2	Overshoot Detection Level	0 to 100	1%	100	Immediately	Setup	6.3.1 6.4.1																					
Pn600	2	Regenerative Resistor Capacity *1	Depends on SERVOPACK Capacity *2	10 W	0	Immediately	Setup	3.6.2																					
Pn601	2	Reserved (Do not change.)	–	–	0	–	–	–																					

*1. Normally set to "0." When using an external regenerative resistor, set the capacity (W) of the regenerative resistor.

*2. The upper limit is the maximum output capacity (W) of the SERVOPACK.

(cont'd)

Parameter No.	Size	Name	Setting Range	Units	Factory Setting	When Enabled	Classification	Reference Section
Pn621 to Pn628 ^{*3}	–	SERVOPACK: Safety Module Parameters	–	–	–	–	–	–

*3. These parameters can be set in SERVOPACKs with safety modules. For details, refer to *Σ-V Series User's Manual, Safety Module* (No.: SIEP C720829 06).

11.3 List of Monitor Displays

The following list shows the available monitor displays.

Parameter No.	Description	Unit
Un000	Motor rotating speed	min ⁻¹
Un001	Speed reference	min ⁻¹
Un002	Internal torque reference (in percentage to the rated torque)	%
Un003 ^{*3}	Rotational angle 1 (encoder pulses from the phase-C origin: decimal display)	encoder pulse ^{*4}
Un004	Rotational angle 2 (from polarity origin (electric angle))	deg
Un005 ^{*1}	Input signal monitor	–
Un006 ^{*2}	Output signal monitor	–
Un007 ^{*6}	Input reference pulse speed (valid only in position control)	min ⁻¹
Un008 ^{*6}	Position error amount (valid only in position control)	reference unit
Un009	Accumulated load ratio (in percentage to the rated torque: effective torque in cycle of 10 seconds)	%
Un00A	Regenerative load ratio (as a percentage of the processable regenerative power: regenerative power consumption in cycle of 10 seconds)	%
Un00B	Power consumed by DB resistance (in percentage to the processable power at DB activation: displayed in cycle of 10 seconds)	%
Un00C ^{*3,*6}	Input reference pulse counter	reference unit
Un00D ^{*3}	Feedback pulse counter	encoder pulse ^{*4}
Un00E ^{*3}	Fully-closed feedback pulse counter	external encoder resolution ^{*5}
Un012	Total operation time	100 ms
Un013 ^{*3}	Feedback pulse counter	reference unit
Un014	Effective gain monitor (gain settings 1 = 1, gain settings 2 = 2)	–
Un015	Safety I/O signal monitor	–
Un020	Motor rated speed	min ⁻¹
Un021	Motor maximum speed	min ⁻¹
Un022 ^{*7}	Installation environment monitor (Operation conditions in various environments can be monitored.)	%

*1. For details, refer to 8.4 *Monitoring Input Signals*.

*2. For details, refer to 8.5 *Monitoring Output Signals*.

*3. For details, refer to 8.3 *Reading 32-bit Data in Decimal Displays*.

*4. For details, refer to 5.4.4 *Electronic Gear*.

*5. For details, refer to 9.3.3 *Setting Encoder Output Pulses (PAO, PBO, and PCO)*.

*6. If the reference pulse input multiplication switching function is enabled, the reference pulse will be multiplied by n to obtain the reference. This function is supported by software version 001A or later.

*7. The monitor Un022 can be used only with SGDV-□□□□□B SERVOPACKs. For details, refer to 2 *Installation of S-V Series USER'S MANUAL, Setup, Rotational Motor* (No.: SIEP S800000 43).

11.4 Parameter Recording Table

Use the following table for recording parameters.

Note: Pn10B, Pn170, and Pn408 have two kinds of digits: the digit which does not need the restart after changing the settings and the digit which needs the restart. The underlined digits of the factory setting in the following table show the digit which needs the restart.

Parameter	Factory Setting						Name	When Enabled
Pn000	0000						Basic Function Select Switch 0	After restart
Pn001	0000						Application Function Select Switch 1	After restart
Pn002	0000						Application Function Select Switch 2	After restart
Pn006	0002						Application Function Select Switch 6	Immediately
Pn007	0000						Application Function Select Switch 7	Immediately
Pn008	0000						Application Function Select Switch 8	After restart
Pn009	0010						Application Function Select Switch 9	After restart
Pn00B	0000						Application Function Select Switch B	After restart
Pn00C	0000						Application Function Select Switch C	After restart
Pn00D	0000						Application Function Select Switch D	After restart
Pn010	0001						Axis Address Selection (for UART/USB communications)	After restart
Pn081	0000						Application Function Select Switch 81	After restart
Pn100	400						Speed Loop Gain	Immediately
Pn101	2000						Speed Loop Integral Time Constant	Immediately
Pn102	400						Position Loop Gain	Immediately
Pn103	100						Moment of Inertia Ratio	Immediately
Pn104	400						2nd Speed Loop Gain	Immediately
Pn105	2000						2nd Speed Loop Integral Time Constant	Immediately
Pn106	400						2nd Position Loop Gain	Immediately
Pn109	0						Feedforward Gain	Immediately
Pn10A	0						Feedforward Filter Time Constant	Immediately
Pn10B	<u>0000</u>						Application Function for Gain Select Switch	—
Pn10C	200						Mode Switch (torque reference)	Immediately
Pn10D	0						Mode Switch (speed reference)	Immediately
Pn10E	0						Mode Switch (acceleration)	Immediately
Pn10F	0						Mode Switch (position error)	Immediately
Pn11F	0						Position Integral Time Constant	Immediately
Pn121	100						Friction Compensation Gain	Immediately
Pn122	100						2nd Gain for Friction Compensation	Immediately
Pn123	0						Friction Compensation Coefficient	Immediately
Pn124	0						Friction Compensation Frequency Correction	Immediately
Pn125	100						Friction Compensation Gain Correction	Immediately
Pn131	0						Gain Switching Time 1	Immediately
Pn132	0						Gain Switching Time 2	Immediately
Pn135	0						Gain Switching Waiting Time 1	Immediately

(cont'd)

Parameter	Factory Setting					Name	When Enabled
Pn136	0					Gain Switching Waiting Time 2	Immediately
Pn139	0000					Automatic Gain Changeover Related Switch 1	Immediately
Pn13D	2000					Current Gain Level	Immediately
Pn140	0100					Model Following Control Related Switch	Immediately
Pn141	500					Model Following Control Gain	Immediately
Pn142	1000					Model Following Control Gain Compensation	Immediately
Pn143	1000					Model Following Control Bias (Forward Direction)	Immediately
Pn144	1000					Model Following Control Bias (Reverse Direction)	Immediately
Pn145	500					Vibration Suppression 1 Frequency A	Immediately
Pn146	700					Vibration Suppression 1 Frequency B	Immediately
Pn147	1000					Model Following Control Speed Feedforward Compensation	Immediately
Pn148	500					2nd Model Following Control Gain	Immediately
Pn149	1000					2nd Model Following Control Gain Compensation	Immediately
Pn14A	800					Vibration Suppression 2 Frequency	Immediately
Pn14B	100					Vibration Suppression 2 Compensation	Immediately
Pn14F	0011					Control Related Switch	After restart
Pn160	0010					Anti-Resonance Control Related Switch	Immediately
Pn161	1000					Anti-Resonance Frequency	Immediately
Pn162	100					Anti-Resonance Gain Compensation	Immediately
Pn163	0					Anti-Resonance Damping Gain	Immediately
Pn164	0					Anti-Resonance Filter Time Constant 1 Compensation	Immediately
Pn165	0					Anti-Resonance Filter Time Constant 2 Compensation	Immediately
Pn170	1401					Tuning-less Function Related Switch	–
Pn200	0000					Position Control Reference Form Selection Switch	After restart
Pn205	65535					Multiturn Limit Setting	After restart
Pn207	0000					Position Control Function Switch	After restart
Pn20A	32768					Number of External Scale Pitch	After restart
Pn20E	4					Electronic Gear Ratio (Numerator)	After restart
Pn210	1					Electronic Gear Ratio (Denominator)	After restart
Pn212	2048					Encoder Output Pulses	After restart
Pn216	0					Position Reference Acceleration/Deceleration Time Constant	Immediately after the motor stops
Pn217	0					Average Movement Time of Position Reference	Immediately after the motor stops
Pn218	1					Reference Pulse Input Multiplication	Immediately

(cont'd)

Parameter	Factory Setting						Name	When Enabled
Pn22A	0000						Fully-closed Control Selection Switch	After restart
Pn281	20						Encoder Output Resolution	After restart
Pn300	600						Speed Reference Input Gain	Immediately
Pn301	100						Internal Set Speed 1	Immediately
Pn302	200						Internal Set Speed 2	Immediately
Pn303	300						Internal Set Speed 3	Immediately
Pn304	500						JOG Speed	Immediately
Pn305	0						Soft Start Acceleration Time	Immediately
Pn306	0						Soft Start Deceleration Time	Immediately
Pn307	40						Speed Reference Filter Time Constant	Immediately
Pn310	0000						Vibration Detection Switch	Immediately
Pn311	100						Vibration Detection Sensibility	Immediately
Pn312	50						Vibration Detection Level	Immediately
Pn324	300						Moment of Inertia Calculating Start Level	Immediately
Pn400	30						Torque Reference Input Gain	Immediately
Pn401	100						Torque Reference Filter Time Constant	Immediately
Pn402	800						Forward Torque Limit	Immediately
Pn403	800						Reverse Torque Limit	Immediately
Pn404	100						Forward External Torque Limit	Immediately
Pn405	100						Reverse External Torque Limit	Immediately
Pn406	800						Emergency Stop Torque	Immediately
Pn407	10000						Speed Limit during Torque Control	Immediately
Pn408	0000						Torque Related Function Switch	–
Pn409	5000						1st Notch Filter Frequency	Immediately
Pn40A	70						1st Notch Filter Q Value	Immediately
Pn40B	0						1st Notch Filter Depth	Immediately
Pn40C	5000						2nd Notch Filter Frequency	Immediately
Pn40D	70						2nd Notch Filter Q Value	Immediately
Pn40E	0						2nd Notch Filter Depth	Immediately
Pn40F	5000						2nd Step 2nd Torque Reference Filter Frequency	Immediately
Pn410	50						2nd Step 2nd Torque Reference Filter Q Value	Immediately
Pn412	100						1st Step 2nd Torque Reference Filter Time Constant	Immediately
Pn415	0						T-REF Filter Time Constant	Immediately
Pn423	0000						Reserved	–
Pn424	50						Torque Limit at Main Circuit Voltage Drop	Immediately
Pn425	100						Release Time for Torque Limit at Main Circuit Voltage Drop	Immediately
Pn456	15						Sweep Torque Reference Amplitude	Immediately
Pn460	0101						Notch Filter Adjustment Switch	Immediately
Pn501	10						Zero Clamp Level	Immediately

(cont'd)

Parameter	Factory Setting					Name	When Enabled
Pn502	20					Rotation Detection Level	Immediately
Pn503	10					Speed Coincidence Signal Output Width	Immediately
Pn506	0					Brake Reference - Servo OFF Delay Time	Immediately
Pn507	100					Brake Reference Output Speed Level	Immediately
Pn508	50					Waiting Time for Brake Signal When Motor Running	Immediately
Pn509	20					Instantaneous Power Cut Hold Time	Immediately
Pn50A	2100					Input Signal Selection 1	After restart
Pn50B	6543					Input Signal Selection 2	After restart
Pn50C	8888					Input Signal Selection 3	After restart
Pn50D	8888					Input Signal Selection 4	After restart
Pn50E	3211					Output Signal Selection 1	After restart
Pn50F	0000					Output Signal Selection 2	After restart
Pn510	0000					Output Signal Selection 3	After restart
Pn511	8888					Input Signal Selection 5	After restart
Pn512	0000					Output Signal Inverse Setting	After restart
Pn513	0000					Output Signal Selection 4	After restart
Pn515	8888					Input Signal Selection 6	After restart
Pn517	0000					Reserved	–
Pn51B	1000					Excessive Error Level Between Servomotor and Load Positions	Immediately
Pn51E	100					Excessive Position Error Warning Level	Immediately
Pn520	5242880					Excessive Position Error Alarm Level	Immediately
Pn522	7					Positioning Completed Width	Immediately
Pn524	1073741824					NEAR Signal Width	Immediately
Pn526	5242880					Excessive Position Error Alarm Level at Servo ON	Immediately
Pn528	100					Excessive Position Error Warning Level at Servo ON	Immediately
Pn529	10000					Speed Limit Level at Servo ON	Immediately
Pn52A	20					Multiplier per One Fully-closed Rotation	Immediately
Pn52B	20					Overload Warning Level	Immediately
Pn52C	100					Derating of Base Current at Detecting Overload of Motor	After restart
Pn52D	50					Reserved	–
Pn52F	0FFF					Monitor Display at Power ON	Immediately
Pn530	0000					Program JOG Operation Related Switch	Immediately
Pn531	32768					Program JOG Movement Distance	Immediately
Pn533	500					Program JOG Movement Speed	Immediately
Pn534	100					Program JOG Acceleration/Deceleration Time	Immediately
Pn535	100					Program JOG Waiting Time	Immediately

(cont'd)

Parameter	Factory Setting						Name	When Enabled
Pn536	1						Number of Times of Program JOG Movement	Immediately
Pn550	0						Analog Monitor 1 Offset Voltage	Immediately
Pn551	0						Analog Monitor 2 Offset Voltage	Immediately
Pn552	100						Analog Monitor Magnification (×1)	Immediately
Pn553	100						Analog Monitor Magnification (×2)	Immediately
Pn560	400						Remained Vibration Detection Width	Immediately
Pn561	100						Overshoot Detection Level	Immediately
Pn600	0						Regenerative Resistor Capacity	Immediately
Pn601	0						Reserved	–

Index

Symbols

/ALM-RST	5-80
/BK	5-11
/CLT	5-65
/COIN	5-43
/C-SEL	5-57
/G-SEL	3-27, 6-60
/HWBB1	5-84
/HWBB2	5-84
/INHIBIT	5-45
/N-CL	5-60
/NEAR	5-44
/P-CL	5-60
/P-CON	5-27
/PSEL	5-38
/PSELA	5-39
/S-ON	5-4
/SPD-A	5-52
/SPD-B	5-52
/SPD-D	5-52
/S-RDY	5-81
/TGON	5-81
/V-CMP	5-31
/VLT	5-50
/WARN	5-80
/ZCLAMP	5-27

A

absolute data reception sequence	5-74
absolute data request signal (SEN)	5-69
absolute encoder battery alarm (A.830)	5-70
absolute encoders	5-66
connection	5-67
set up and initialization	5-73
AC reactor	3-47
additional adjustment function	6-59
advanced autotuning (Fn201)	6-19
anti-resonance control adjustment function	6-26
calculating moment of inertia	6-22
feedforward	6-27
friction compensation	6-27
mode selection	6-22
notch filter	6-26
STROKE (travel distance) setting	6-23
type selection	6-22
vibration suppression	6-26
advanced autotuning by reference (Fn202)	6-29
anti-resonance control adjustment function	6-34
feedforward	6-35
friction compensation	6-35
mode selection	6-32
notch filter	6-34
type selection	6-32
vibration suppression	6-34
alarm code output	10-2
alarm code output signals	5-79
alarm history display (Fn000)	7-3
alarm reset	10-2
alarm reset method	5-80
ALM	5-79

ALO1	5-79
ALO2	5-79
ALO3	5-79
ambient/storage humidity	1-5
anti-resonance control adjustment function (Fn204)	6-48
application example of safety functions	5-88
automatic adjustment of reference offset	
speed control	5-23
torque control	5-47
automatic gain switching	6-60
automatic offset-signal adjustment of the motor current detection signal (Fn00E)	7-18
automatically setting the notch filter	6-13

B

baseblock	2-3
battery	
battery case	5-66
battery replacement	5-70
installing the battery in the host controller	5-68
using an encoder cable with a battery case	5-67, 5-71
BB	iii, 4-16
brake operation delay time	5-10
brake signals	5-11

C

CCW	5-5, 9-13
CE	xiii
changing detection timing of overload (low load) alarm (A.720)	5-21
changing detection timing of overload warning (A.910)	5-20
changing input signal allocations	3-26
changing output signal allocations	3-30
checking output torque limiting during operation	5-65
clear signal	5-37
clearing alarm history (Fn006)	7-13
CLR	5-37
CN1	3-19
CN2	3-39
CN3	1-2
CN7	1-2
CN8	3-21
coast to a stop	5-7
combination of control methods	5-55
compatible adjustment function	6-66
confirming safety functions	5-89
connecting a reactor for harmonic suppression	3-47
connecting regenerative resistors	3-41
connection example of EDM1 output signal	5-87
connection example of HWBB input signals	5-84
connection to host controller (interface)	
reference input circuit	3-33
sequence input circuit	3-35
sequence output circuit	3-37
connector CN5 for analog monitor	6-6
contact inputs	5-52
control method selection	5-3
current control mode selection	6-65
current gain level setting	6-65
CW	5-5, 9-13

D

DATA/SHIFT key	2-2
DC power supply input	
parameter setting	3-15
wiring example	3-16

DC reactor	3-47
decelerate to stop	5-7
display of servomotor ID in feedback option module (Fn01F)	7-30
display of SERVOPACK and servomotor ID (Fn01E)	7-28
DOWN key	2-2
dynamic brake	5-7

E

EasyFFT (Fn206)	7-34
EDM1	5-86
electronic gear	5-39
electronic gear ratio	5-40
encoder output pulse setting	5-30
encoder output pulses	5-29
encoder resolution	5-30
encoder signal (CN2) names and functions	3-39
error detection in HWBB signal	5-83
european directives	xiii
example of connection to host controllers	11-2
example of operating with internal set speeds	5-54
examples of encoder connection	3-39
external device monitor	5-86
external regenerative resistor	3-41
external torque limit	5-60

F

feedforward	6-66
feedforward compensation	6-66
FG	3-20, 3-22
forward external torque limit	5-60
friction compensation	6-63
fully-closed loop control	
alarm detection	9-20
analog monitor signal	9-21
analog signal input timing	9-4
connection example of external encoder by Heidenhain	9-5
connection example of external encoder by Magnescale Co., Ltd.	9-5
connection example of external encoder by Mitutoyo Corporation	9-5
connection example of external encoder by Renishaw plc	9-5
electronic gear	9-19
external absolute encoder data reception sequence	9-16
internal block diagram	9-3
motor rotation direction	9-13
serial converter unit	9-3
setting encoder output pulses	9-15
sine wave pitch (frequency) for an external encoder	9-15
speed feedback method	9-21
system configuration	9-2

G

gain adjustment of analog monitor output (Fn00D)	7-16
Gr.1 alarm	5-14
Gr.2 alarm	5-14
grounding	3-45

H

hard wire base block (HWBB) function	5-82
hard wire base block (HWBB) state	5-83
harmonized standards	xiii, 1-5
holding brakes	5-9

I

I/O signal connection example	
position control	3-23

speed control	3-22
torque control	3-24
initial incremental pulses	5-75
initializing parameter settings (Fn005)	7-12
input signal (CN1)	
allocations	3-25
monitoring	8-5
names and functions	3-19
instantaneous power interruption settings	5-16
internal block diagrams	1-9
internal set speed	5-53
internal set speed control	5-52
internal torque limit	5-59

J

JOG operation (Fn002)	7-4
-----------------------	-----

L

limit switches	5-6
limiting torque	5-59
line driver output	5-34
list of alarms	10-2
list of monitor displays	8-2
list of warnings	10-21

M

main circuit	
names and functions of terminals	3-2
wires	3-4, 3-11
wiring examples	3-5
manual adjustment of reference offset	
speed control	5-25
torque control	5-47
manual gain switching	6-60
manual offset-signal adjustment of the motor current detection signal (Fn00F)	7-19
MODE/SET key	2-2
monitor display at power ON	8-10
monitor displays (Un□□□)	2-9, 11-35
monitor factor	6-7
monitoring safety input signals	8-9
multiturn limit disagreement alarm (A.CC0)	5-78
multiturn limit setting	5-77

N

noise filter	3-45
N-OT	5-6
notch filter	6-74

O

offset adjustment of analog monitor output (Fn00C)	7-14
one-parameter tuning (Fn203)	6-37
anti-resonance control adjustment function	6-44
feedforward	6-45
friction compensation	6-45
notch filter	6-44
tuning mode	6-40, 6-42
type selection	6-40, 6-42
one-parameter tuning example	6-46
online vibration monitor (Fn207)	7-37
open-collector output	5-34
operator displays during testing without motor	4-16
origin search (Fn003)	7-6
origin setting (Fn020)	7-32
output phase form	5-29

output signal (CN1)	
allocations	3-29
monitoring	8-7
names and functions	3-20
overtravel (OT)	5-6
overtravel warning function	5-8

P

panel operator	
names and functions	2-2
status display mode	2-3
PAO	5-29
parameter	
classification	2-5
how to make numeric settings using parameters	2-6
how to select functions using parameters	2-8
parameters for numeric settings	iv, 2-5
parameters for selecting functions	iv, 2-5
tuning parameters	2-5
parameter recording table	11-36
parameters	11-10
PBO	5-29
PCO	5-29
position control	
connection example	5-34
electrical specifications	5-36
filter	5-33
reference pulse form	5-33
position integral	6-74
positioning completed signal	5-43
positioning near signal	5-44
P-OT	5-6
precautions for safety functions	5-89
precautions for wiring	3-18
precautions on connecting noise filter	3-46
program JOG operation (Fn004)	7-8
proportional control	6-69
protection class/pollution degree	1-5
PULS	3-20, 5-33, 5-36

R

reading 32-bit data in displays	8-4
reference pulse form	5-33
reference pulse inhibit function	5-45
reference unit	5-39
resetting configuration errors in option modules (Fn014)	7-25
resetting the HWBB state	5-83
reverse external torque limit	5-60
risk assessment	5-82
rotation detection output signal	5-81
rotational serial data	5-75, 5-76
RUN	4-16

S

safety function	5-82
safety function signal (CN8) names and functions	3-21
safety precautions on adjustment of servo gains	6-9
SEMI F47 function	5-17
SEN	5-69
servo alarm output signal	5-79
servo gains	6-3
servo ON	5-4
servo ready output signal	5-81
servomotor model display (Fn011)	7-22
servomotor rotation direction	5-5

SERVOPACK

basic specifications	1-5
example of servo system configuration	
(SGDV-□□□A01□)	1-18
example of servo system configuration	
(SGDV-□□□D01A)	1-20
example of servo system configuration	
(SGDV-□□□F01A)	1-17
inspection and maintenance	1-22
model designation	1-21
part names	1-2
precautions when using more than one SERVOPACK	3-17
ratings	1-3
speed/position/torque control	1-8
status display mode	2-3
setting encoder output pulse	5-30
setting motor overload detection level	5-20
setting regenerative resistor capacity	3-43
SIGN	3-20, 5-33, 5-36
signal setting for speed control	5-22
single-phase, 200 V power supply input	
main circuit wire for SERVOPACKs	3-11
molded-case circuit breaker	3-14
parameter setting	3-11
power supply capacities and power losses	3-13
wire types	3-3
wiring example	3-13
smoothing	5-42
soft start	5-26
soft start time setting	1-5
software reset (Fn030)	7-33
software version display (Fn012)	7-24
specifications of EDM1 output signal	5-87
specifications of HWBB signals	5-84
speed coincidence signal	5-31
speed control	5-22
speed control range	1-5
speed detection method selection	6-65
speed feedforward	6-68
speed limit in torque control	5-50
speed reference filter	5-26
speed reference input signal	5-22
speed regulation	1-5
standard power supply input	
main circuit wires for SERVOPACKs	3-4
molded-case circuit breaker	3-9
power supply capacities and power losses	3-8
wire types	3-3
wiring examples	3-5
stopping method for servomotor after /S-ON signal is turned OFF	5-14
stopping method for servomotor when an alarm occurs	5-14, 10-2
storage temperature	1-5
surrounding air temperature	1-5
switching condition A	6-60
switching gain settings	6-59
switching internal set speed control	5-55
switching multiplier of reference pulse	5-38
switching other than internal set speed control	5-58

T

test without motor function	4-13
time stamps	7-3
torque control	5-46
torque control tolerance	1-5
torque feedforward	6-66

torque limit function for low DC power supply voltage for main circuit- - - - -	5-17
torque limiting using an analog voltage reference - - - - -	5-61
torque limiting using an external torque limit and analog voltage reference- - - - -	5-63
torque reference filter - - - - -	6-72
torque reference input gain - - - - -	5-47
torque reference input signals- - - - -	5-46
T-REF - - - - -	5-46
trial operation	
connecting a safety function device- - - - -	4-6
inspection and checking before trial operation - - - - -	4-2
trial operation for servomotor without load- - - - -	4-2
trial operation for servomotor without load from host reference- - - - -	4-3
trial operation in position control - - - - -	4-10
trial operation in speed control - - - - -	4-8
trial operation of servomotor with brakes- - - - -	4-12
trial operation under position control from the host with the SERVOPACK used for speed control - - - - -	4-9
trial operation with the servomotor connected to the machine	4-11
troubleshooting	
alarms - - - - -	10-6
warnings- - - - -	10-22
troubleshooting malfunction based on operation and conditions of the servomotor- - - - -	10-25
tuning parameters- - - - -	2-5
tuning-less function - - - - -	6-12
tuning-less level settings (Fn200) - - - - -	6-13

U

UL- - - - -	xiii
UP key - - - - -	2-2
using the mode switch (P/PI switching) - - - - -	6-70
utility functions (Fn□□□) - - - - -	2-4, 11-9

V

vibration detection level initialization (Fn01B) - - - - -	7-26
vibration suppression function (Fn205) - - - - -	6-54
vibration/shock resistance - - - - -	1-5
V-REF - - - - -	5-22

W

warning code output - - - - -	10-21
warning output signal - - - - -	5-80
wiring for noise control- - - - -	3-44
write prohibited setting (Fn010) - - - - -	7-20

Z

zero clamp function - - - - -	5-27
zero clamp mode - - - - -	5-7









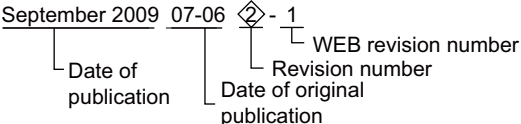



Revision History

The revision dates and numbers of the revised manuals are given on the bottom of the back cover.

MANUAL NO. SIEP S800000 45B

Published in Japan September 2009 07-06  - 1



Date of Publication	Rev. No.	WEB Rev. No.	Section	Revised Content
July 2014		0	4.3.1	Addition: Information on types of safety function's jumper connectors
			6.1.3	Revision: Output unit when using an SGMCS direct drive servomotor
			9.1.4, 9.3.5	Addition: External encoder by Heidenhain (models: LIC4100-series models)
			10.1.1, 10.1.2	Addition: A.F50
July 2013		0	Preface, 1.3.2	Revision: Description of Harmonized Standards EN 55011 /A2 changed to EN 55011
			Back cover	Revision: Address
March 2013		0	Back cover	Revision: Address
September 2012		0	Back cover	Revision: Address
February 2012		0	–	Based on Japanese user's manual, SIJP S800000 45J <17> printed in August 2011.
			All chapters	Completely revised
			Back cover	Revision: Address
September 2011		0	–	Based on Japanese user's manual, SIJP S800000 45I <16> printed in April 2011.
			All chapters	Completely revised
April 2011		0	1.5	Revision: Illustration of CD
March 2011		0	Front cover	Addition: Servomotor model SGMSV
			1.4.4, 1.4.5, 1.5.2, 8.1, 11.3	Addition: Description of SGD V-□□□□□□ B SERVOPACKS
			9.3.5	Addition: External encoder made by Mitutoyo ST788A/ST788AL ST789A/ST789AL
			9.3.3 (2), 9.3.5	Addition: Notes when using external encoders
December 2010		0	–	SIEP S800000 45D<5>-1 available on the web.
October 2010		1	Front cover	Revision: Format
			9.1.4 (4), 9.3.5 Index	Revision: Sony Manufacturing Systems Corporation changed to Magnescale Co., Ltd.
			9.3.3 (2) 11.2.2	Revision: Setting unit of Pn281 1 pulse/pitch changed to 1 edge/pitch
			Back cover	Revision: Address, format
April 2010		0	–	SIEP S800000 45D<4>-1, available on the web.
April 2010		1	5.9.5 (2)	Revision: Description of the initial incremental pulses
			6.8.1 (4), (5)	Revision: Applicable control method
			7.15 (2)	Revision: Display after Operation in step 6
March 2010		0	–	Based on Japanese user's manual, SIJP S800000 45G<10>-1, available on the web in March 2010.
			All chapters	Completely revised
October 2009		0	–	SIEP S800000 45C<2>-1, available on the web.
			Back cover	Revision: Address

Date of Publication	Rev. No.	WEB Rev. No.	Section	Revised Content
September 2009	②	1	Preface	Addition: Warranty
			Back cover	Revision: Address
October 2008		0	–	Based on Japanese user's manual, SIJP S800000 45E<6> printed in September 2008.
			All chapters	Completely revised
			Back cover	Revision: Address
December 2007	①	0	–	Based on Japanese user's manual, SIJP S800000 45C<3> printed in November 2007.
			1.3.1, 1.5, 3.1.1, 3.1.2 (2)	Table revised
			3.1.3	Revision: Figure title for single-phase 100 V SERVOPACK
June 2007	–	–	–	First edition

AC Servo Drives Σ -V Series USER'S MANUAL Design and Maintenance Rotational Motor Analog Voltage and Pulse Train Reference

IRUMA BUSINESS CENTER (SOLUTION CENTER)

480, Kamifujisawa, Iruma, Saitama 358-8555, Japan
Phone 81-4-2962-5151 Fax 81-4-2962-6138
<http://www.yaskawa.co.jp>

YASKAWA AMERICA, INC.

2121 Norman Drive South, Waukegan, IL 60085, U.S.A.
Phone 1-800-YASKAWA (927-5292) or 1-847-887-7000 Fax 1-847-887-7310
<http://www.yaskawa.com>

YASKAWA ELÉTRICO DO BRASIL LTDA.

Avenida Piraporinha 777, Diadema, São Paulo, 09950-000, Brasil
Phone 55-11-3585-1100 Fax 55-11-3585-1187
<http://www.yaskawa.com.br>

YASKAWA EUROPE GmbH

Hauptstraße 185, Eschborn 65760, Germany
Phone 49-6196-569-300 Fax 49-6196-569-398
<http://www.yaskawa.eu.com>

YASKAWA ELECTRIC KOREA CORPORATION

9F, Kyobo Securities Bldg. 26-4, Yeouido-dong, Yeongdeungpo-gu, Seoul, 150-737, Korea
Phone 82-2-784-7844 Fax 82-2-784-8495
<http://www.yaskawa.co.kr>

YASKAWA ELECTRIC (SINGAPORE) PTE. LTD.

151 Lorong Chuan, #04-02A, New Tech Park 556741, Singapore
Phone 65-6282-3003 Fax 65-6289-3003
<http://www.yaskawa.com.sg>

YASKAWA ELECTRIC (CHINA) CO., LTD.

12F, Carlton Bld., No.21 HuangHe Road, HuangPu District, Shanghai 200003, China
Phone 86-21-5385-2200 Fax 86-21-5385-3299
<http://www.yaskawa.com.cn>

YASKAWA ELECTRIC (CHINA) CO., LTD. BEIJING OFFICE

Room 1011, Tower W3 Oriental Plaza, No.1 East Chang An Ave.,
Dong Cheng District, Beijing 100738, China
Phone 86-10-8518-4086 Fax 86-10-8518-4082

YASKAWA ELECTRIC TAIWAN CORPORATION

9F, 16, Nanking E. Rd., Sec. 3, Taipei 104, Taiwan
Phone 886-2-2502-5003 Fax 886-2-2505-1280



YASKAWA ELECTRIC CORPORATION

In the event that the end user of this product is to be the military and said product is to be employed in any weapons systems or the manufacture thereof, the export will fall under the relevant regulations as stipulated in the Foreign Exchange and Foreign Trade Regulations. Therefore, be sure to follow all procedures and submit all relevant documentation according to any and all rules, regulations and laws that may apply.

Specifications are subject to change without notice for ongoing product modifications and improvements.

© 2007-2014 YASKAWA ELECTRIC CORPORATION. All rights reserved.

MANUAL NO. SIEP S800000 45J

Published in Japan July 2014 07-6 -0

13-6-9

Original instructions