

Vacuum Circuit Breakers

Motor-spring stored energy closing mechanism
24kV, 16kA



Fuji Vacuum Circuit Breaker

...for Safe Operation, Easy Handling and Compactness

Vacuum circuit breakers are compact designed for safe operation, high reliability and easy maintenance, and are widely used for various types of high voltage circuits.

Fuji HS series vacuum circuit breakers (VCB) have been developed through the use of our many years of successful experience and advanced technology. They are compact and light-mass (weight), and are available in a number of current ratings.

Features

Compact, light-mass design

Vacuum circuit breakers have a small switching stroke as compared with other types of circuit breakers, so their breaking unit is small in size. To take full advantage of this feature, the operating mechanism has been designed to reduce the size and mass of the circuit breakers.

Spring closing system

The vacuum circuit breakers use a motor-spring stored-energy mechanism (rapid auto-reclosing type) to provide stabilized electrical and mechanical characteristics and to reduce the closing operating current.

Safe operation and simplified maintenance

- The operating mechanism is mounted on the front of the frame and the live parts are mounted on the rear. Thus, the operating mechanism is completely isolated from the live parts (dead front type).



Stable breaking performance

The excellent insulation recovery characteristics of the vacuum interrupter allow it to react quickly from small current to short-circuit currents, and also to exhibit a stable interrupting performance in double earth fault and out-of-phase currents.



Ratings and Specifications

Standard ratings and specifications of Fuji HS series VCB

Type		HS1620X-06Mf-ET	
Ratings	Voltage	[kV]	24
	Normal current	JEC	[A] 600
		IEC	[A] 630
	Short-circuit breaking current	[kA]	16
	frequency	[Hz]	50 / 60
	Short-circuit breaking capacity (reference value)	[MVA]	665
	Short-circuit making current (peak value)	[kA]	40
	Short-time withstand current	JEC, 2s	[kA] 16
		IEC, 1s*1	[kA] 16
	Breaking time	[cycle]	3
Rated withstand voltage	1 min power	JEC [kV] 50	
	frequency	IEC [kV] 50	
	Impulse (1.2 x 50 μ s)	[kV] 125	
No-load closing time		[s] 0.04	
Rated operating sequence	JEC	O-1min-CO-3min-CO, CO-15s-CO or O-0.35s-CO-1min-CO	
	IEC	O-3min-CO-3min-CO, CO-15s-CO or O-0.3s-CO-3min-CO O-0.3s-CO-15s-CO	
Opening time	JEC	[s] 0.03	
	IEC	[s] 0.03	
Operating system	Closing system	Motor-spring stored-energy (rapid auto-reclosing) (M)	
	Operating voltage and current for closing		100V, 110V 2A
		AC, DC	200V, 220V 1A*3
	Control voltage and current for closing		100V, 110V 5A
		AC, DC	200V, 220V 2.5A*3
Tripping system*2	Shunt trip (f)		
Operating voltage and current for tripping		100V, 110V 4A	
	DC	200V, 220V 2A*3	
No. of auxiliary switches (for external circuit)	4NO + 4NC, switching capacity : 100/110VAC: 20/10A, 100/110VDC: 5/3A		
Service life	Mechanical	[time]	10000
	Rated normal current switching	[time]	10000
Installation	X		
Mass (for draw-out type)	[kg]	144	
Connection diagrams (page 5)			
Dimensions (page 6)	 		

Type designations

HS1620X-06Mf-ET

② ③ ④ ⑤ ⑥ ⑦
①

- ① **Basic type**
• 24kV, 16kA : HS....-ET
- ② **Short-circuit breaking current**
Rated [kA] Symbol
16 16
- ③ **Voltage**
Rated [kV] Symbol
24 20
- ④ **Installation**
Type Symbol
Draw-out unit type with shutter X
- ⑤ **Normal current**
Rated [A] Symbol
600, 630 06
- ⑥ **Closing system***
System Symbol
Motor-spring stored-energy (rapid auto-reclosing) M
- ⑦ **Tripping system***
System Symbol
Shunt trip f

Note: * For closing and tripping systems, specify the type and operating voltage.

Notes: * 1 Contact Fuji for the information concerning to the 3s time rating of IEC.

* 2 If condenser tripping mechanism is required, connect a condenser tripping device VCB-TLA (optional accessory) to an AC power supply.

* 3 Specify the Voltage.

Construction

The Fuji VCB features a dead front structure; the operating mechanism and control circuit are mounted on the front of the circuit breaker, and the vacuum interrupter and main circuit terminals are on the rear to avoid accidental touching with the live parts. These parts are enclosed in a metal cover to prevent them from making contact with the live parts during operation.

■ Closing mechanism

The closing mechanism is simple in design and provides high reliability. The circuit breakers use a motor-spring stored-energy closing mechanism of the rapid auto-reclosing type.

Motor-spring operation

The motor-spring operating mechanism of Fuji VCB is designed to carry out the closing sequence using the stored-energy in the closing spring supplied by the motor.

The operation mechanism incorporates springs capable of storing the energy required for an OFF-ON-OFF sequence when the breaker has been closed. The closing spring is recharged automatically after closing. This breaker model is suitable for rapid auto-reclosing duty. It can be used for reclosing since the charging time for the motor mechanism is 15s or less.

Operating mechanism

— E types

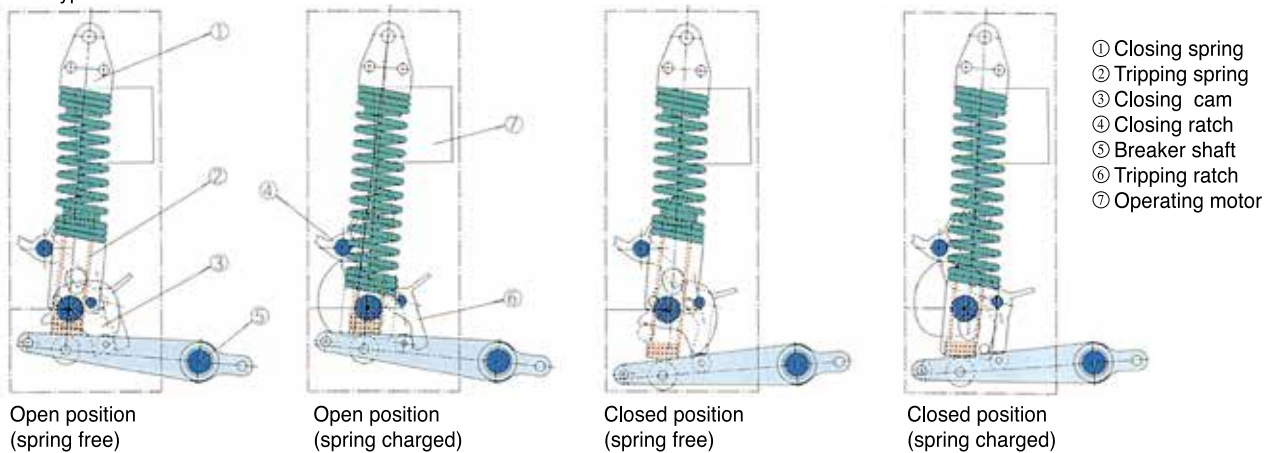

■ Tripping system

The VCB normally employs a shunt trip utilizing 100/110VDC.

If it is desired to use the condenser tripping type, connect a condenser tripping device, available as an optional accessory, to the shunt trip unit.

Shunt trip (f)

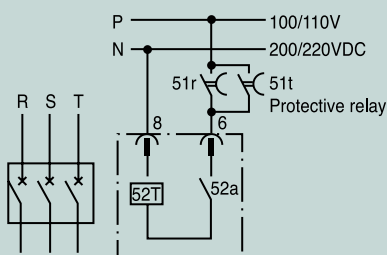

Condenser tripping device (separate supply, separate mount)

Outline drawings [Unit:mm]

VCB-TLA types

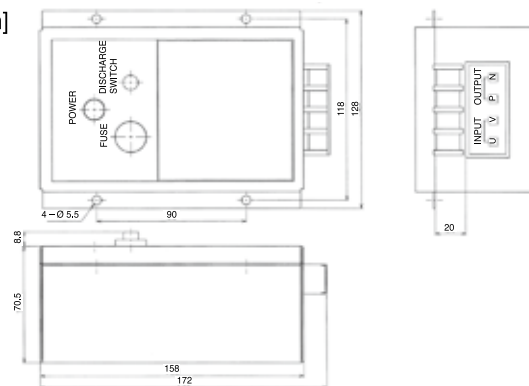

Specifications

Name	Type	Rated input voltage AC [V]	Effective time for tripping	VCB shunt trip coil DC [V]
Condenser tripping device	VCB-TLA	100/110	Within 30s after AC power disappeared	100/110

Vacuum Interrupter

In the vacuum interrupter, there is a pair of cup contacts, each having oblique slots.

This contact structure allows a current to flow along a winding path as shown by "1" in the illustration below.

When the contacts open, the arc deflects in the direction shown by "2" and rotates in the direction shown by "3".

The arc is driven round the contact surface without arc stagnation, and is extinguished in a short time. This prevents local overheating of the contact surface and uneven wear of the contacts, thereby providing a longer service life.

Since the contacts are made of a special material, chopping current flowing into the contacts is reduced to 3.5A.

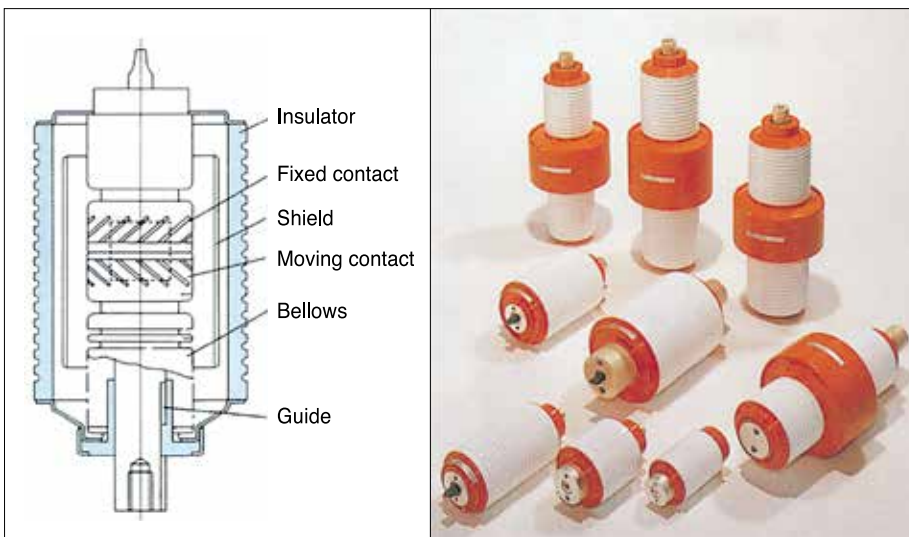

Service life

Judgement of vacuum degree

The vacuum degree in the vacuum interrupter is an important factor for operation of the VCB.

The interrupter of Fuji VCB is designed to maintain a high vacuum for a long period of time. It is factory tested to insure reliable performance. When checking the vacuum degree, use the following procedure. With VCB in the "open" condition, apply a commercial frequency voltage (ex. 22kV effective value for VCB rated at 7.2kV) for 1min time across the poles of the same phase. When the vacuum interrupter withstands this voltage, the vacuum degree is normal.

Mechanical life

The VCB has a simple and excellent operating mechanism, so the mechanical stress developed at the time of operation remains the constant and hence the mechanical characteristic is kept stabilized for many years of use. For the mechanical life, refer to the table on page 2. Fuji VCB is equipped with an operating counter for check of the mechanical life.

Electrical life

The electrical life of the vacuum interrupter is determined by the switching of load as shown in the table on page 2.

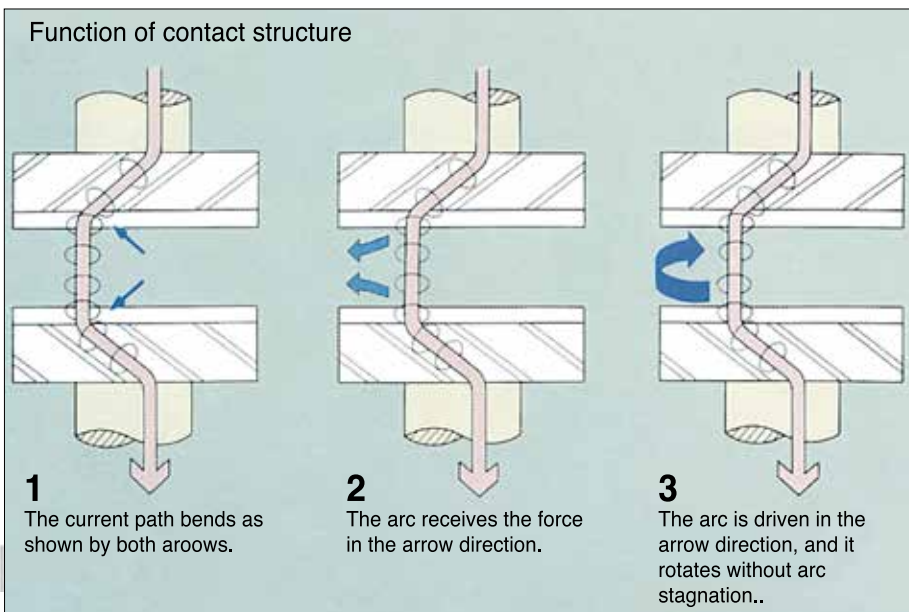

Connection Diagrams and Outline Drawings

A HS1620

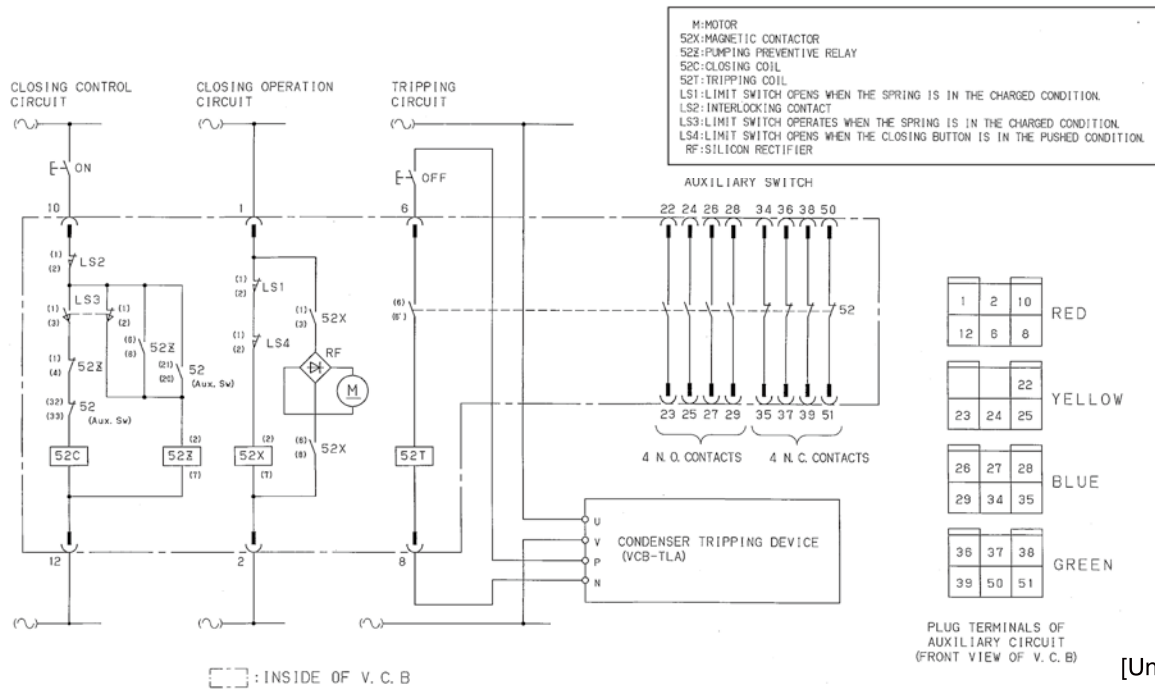

Dimensions within the lines (□) are used for mounting

B HS1620X...ET(630A)

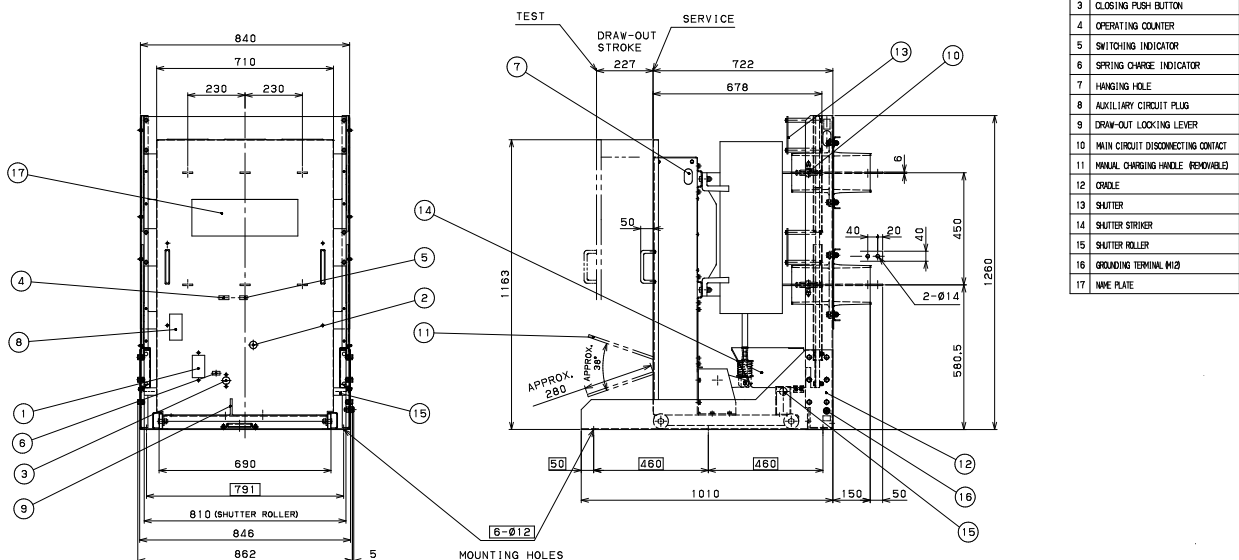

Fuji Electric FA Components & Systems Co., Ltd.

5-7, Nihonbashi Odemma-cho, Chuo-ku, Tokyo 103-0011, Japan
Phone: +81-3-5847-8041 Fax: +81-3-5847-8171
URL <http://www.fujielectric.co.jp/fcs/>