



YASKAWA

# YASKAWA AC Drive High Performance Vector Control A1000

200 V CLASS, 0.4 to 110 kW  
400 V CLASS, 0.4 to 630 kW



## The Answer

Certified for  
ISO9001 and  
ISO14001



JQA-0422



JQA-EM0498

# *The Birth of Yaskawa's Ace Drive*

*Offering limitless possibilities....*

A top quality drive: silent, beautiful, and incredibly powerful. Perfectly designed functions open a new field with A1000. A product only possible from Yaskawa, knowing everything there is to know about the world of drive technology to create the most efficient operation possible with an inverter drive. You just have to try it to know how easy it is to use. High level, Yaskawa quality. Integrating the latest vector control technology in a general-purpose drive with the performance of a higher order demanded by the drives industry. A1000 is the answer to user needs, carrying on the Yaskawa traditions of absolute quality in this next generation product line.



The Answer is  
**A1000**

# Contents

Features	4
Features for Every Application	10
Product Lineup	14
Model Selection	15
Software Functions	16
Parameter List	18
Basic Instructions	24
Standard Specifications	26
Standard Connection Diagram	28
Dimensions	30
Fully-Enclosed Design	32
Peripheral Devices and Options	34
Application Notes	58
YASKAWA AC Drive Series	64
Global Service Network	65

The Drive for  
a Greener World

Motor Drive Performance  
Leading the Pack

Transforming the Application Installation  
with Unparalleled Performance.



\* CE and UL approval still pending for some models

# A

# Motor Drive Performance Leading the Pack

## The Most Advanced Drive Technology

- ▲ Capable of driving any kind of motor.  
A1000 runs not only induction motors, but also synchronous motors like IPM and SPM motors with high performance current vector control.  
Currently developing PM motor compatibility for drives 450 kW and above.
- ▲ Minimize equipment needed for your business by using the same drive to run induction and synchronous motors.
- ▲ Switch easily between motor types with a single parameter setting.

	Synchronous motor (SPM) EMR1 Series	Synchronous motor (IPM) Super Energy-Saving Motor
Features	<ul style="list-style-type: none"> <li>Ultra-compact, ultra-light</li> <li>Energy saving, high efficiency</li> <li>High-performance control without a motor encoder</li> </ul>	<ul style="list-style-type: none"> <li>Compact, light</li> <li>Energy saving, high efficiency</li> <li>High starting torque without an encoder.</li> <li>Positioning capability without an encoder.</li> </ul>
Capacities	200 V: 0.4 to 7.5 kW	200 V: 0.4 to 75 kW 400 V: 0.4 to 300* kW

\* 160 kW without PG

## Rotor Positioning without Motor Encoder

- ▲ Use an IPM motor to perform position control without motor feedback.  
Electrical saliency in IPM motors makes it possible to detect speed, direction, and rotor position without the use of a motor encoder.
- ▲ Precision positioning functionality without an upper controller.  
Visual programming in DriveWorksEZ lets the user easily create a customized position control sequence, without the use of a motor encoder.

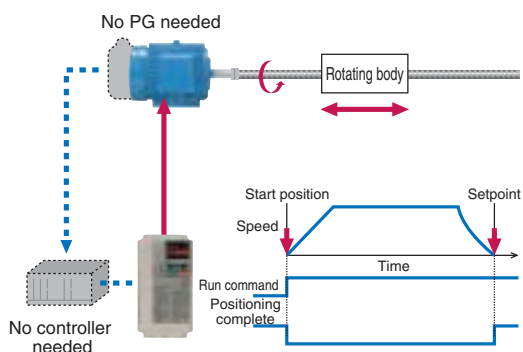

## Cutting-Edge Torque Characteristics

- ▲ Powerful torque at 0 Hz, without a motor encoder\*  
Once out of reach for AC drives, Yaskawa now offers advanced control features without a motor encoder. Achieve even more powerful starting torque at zero speed with an IPM motor.  
\* No speed sensors or pole sensors required.



### Synchronous Motor

- Advanced Open Loop Vector Control for PM  
200% rated torque at 0 r/min\*, speed range of 1:100
- Closed Loop Vector Control for PM  
200% rated torque at 0 r/min\*, speed range of 1:1500

\* Achieving this torque output requires a larger capacity drive.

### ● Torque characteristics

[Advanced Open Loop Vector Control for PM with an IPM motor]

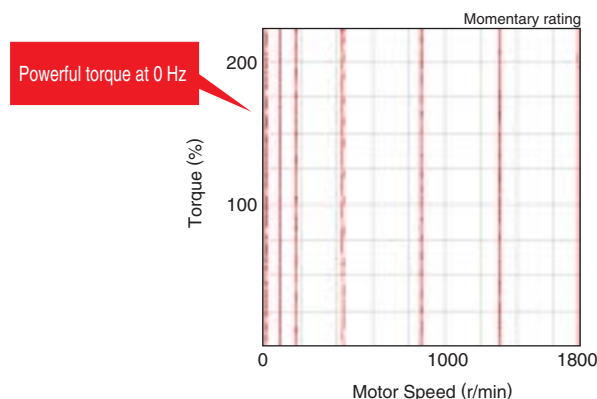

### ● Comparing the speed control range

[Advanced Open Loop Vector Control for PM with an IPM motor]

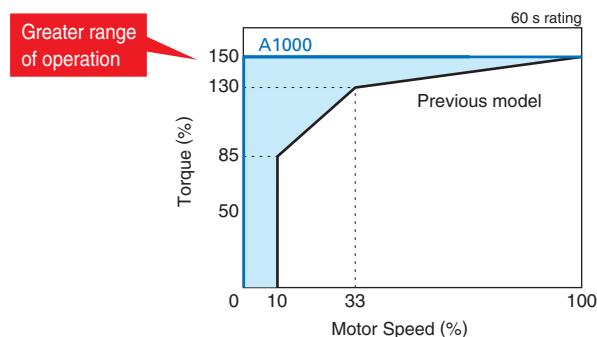

- ▲ High-performance current vector control achieves powerful starting torque with an induction motor.



### Induction Motor

- Open Loop Vector Control  
200% rated torque at 0.3 Hz\*, speed range of 1:200
- Closed Loop Vector Control  
200% rated torque at 0 r/min\*, speed range of 1:1500

\* Achieving this torque output requires a larger capacity drive.

## Loaded with Auto-Tuning Features

- ▲ Auto-Tuning features optimize drive parameters for operation with induction motors as well as synchronous motors to achieve the highest performance levels possible.
- ▲ Perfects not only the drive and motor performance, but also automatically adjusts settings relative to the connected machinery.
  - A variety of ways to automatically optimize drive settings and performance

 Tuning the Motor	
Rotational Auto-Tuning	Applications requiring high starting torque, high speed, and high accuracy.
Stationary Auto-Tuning	Applications where the motor must remain connected to the load during the tuning process.
Line-to-Line Resistance Auto-Tuning	For re-tuning after the cable length between the motor and drive has changed, or when motor and drive capacity ratings differ.
Energy-Saving Auto-Tuning	For running the motor at top efficiency all the time.

 Tuning the Load	
Inertia Tuning	Optimizes the drive's ability to decelerate the load. Useful for applications using KEB and Feed Forward functions.
ASR Gain Auto-Tuning * Automatic Speed Regulator	Automatically adjusts ASR gain to better match the frequency reference.

Note: Not available in models 450 kW and above.

- ▲ Brand-new Auto-Tuning methods.  
A1000 continuously analyzes changes in motor characteristics during run for highly precise speed control.

## Smooth Operation

- ▲ Smooth low speed operation thanks to even better torque ripple suppression.
  - Comparing torque ripple at zero speed (Closed Loop Vector)

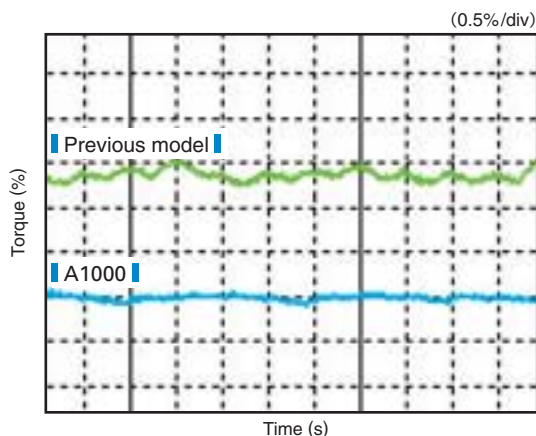

## Tackling Power Loss and Recovery

- ▲ A1000 offers two ways to handle momentary power loss.
- ▲ A1000 is capable of handling momentary power loss for induction motors as well as synchronous motors-- without the use of a motor encoder.

### ● Speed Search

Easily find the speed of a coasting motor for a smooth restart.

#### Applications

Perfect for fans, blowers, and other rotating, fluid-type applications.

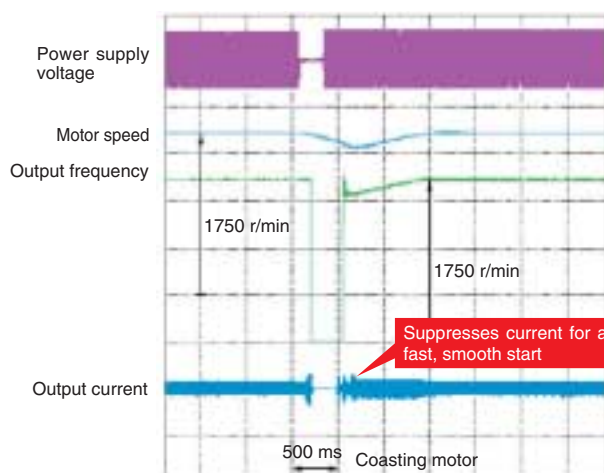

### ● KEB

Keep the motor running without allowing it to coast.

#### Applications

Highly recommended for film lines and other applications requiring continuous operation.

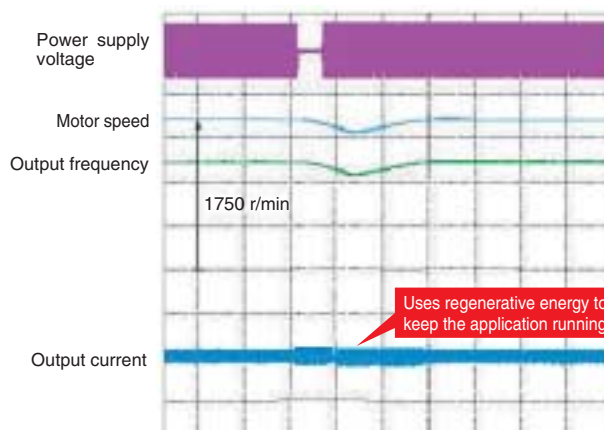

Note: Requires a separate sensor to detect power loss. The drive may trip depending on load conditions, and the motor coast to stop.

- ▲ Ride through power loss for up to 2 seconds.\*
  - Crucial for semi-conductor manufacturers
  - No need to purchase a back-up power supply
  - Detects, outputs an undervoltage signal during power loss

\* The Momentary Power Loss Recovery Unit option may be required depending on the capacity of the drive.



# The Drive for a Greener World

## Energy Saving

### Next-Generation Energy Saving

- ▲ Loaded with the most advanced energy-saving control technology\*  
Energy Saving control makes highly efficient operation possible with an induction motor.  
\* Not available in models 450 kW and above.
- ▲ Amazing energy saving with a synchronous motor\*  
Combining the high efficiency of a synchronous motor along with A1000's Energy Saving control capabilities allows for unparalleled energy saving.  
\* Not available in models 450 kW and above.

#### ● Efficiency using a motor drive

Example shows a 200 V 3.7 kW drive in a fan or pump application.

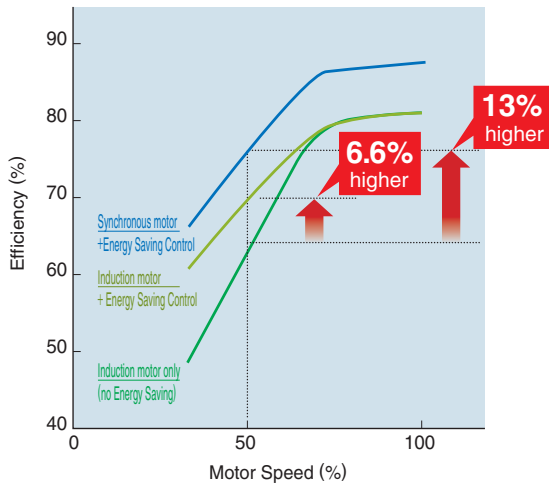

#### ● Examples of energy saving with drives

**Conditions**

- A** : Induction motor + A1000
- B** : IPM motor + A1000

Annual energy savings for an HVAC fan application running 100 3.7 kW motors. Electric costs of 15 cents/kWH, operating 365 days/year

---

**Annual Energy Savings**

- A** : Induction motor + A1000  
Power consumption: 1,903,100 kWh  
Electrical costs: **\$285,500**
- B** : IPM motor + A1000  
Power consumption: 1,754,600 kWh  
Electrical costs: **\$263,200**

**Total Energy Savings \$22,300**

Annual savings on energy costs: (A) vs. (B)  
Energy saved: 148,500 kWh  
Electrical costs: **\$22,300**

**Annual reduction in CO<sub>2</sub>**  
148,500 kWh × 0.555 ÷ 1,000 = **82.4 tons!**  
Assumes 1 kWh of power consumed creates 0.555 kg/kWH of CO<sub>2</sub>

## Environmental Features

### Protective Design

- ▲ A variety of protective designs are available to reinforce the drive against moisture, dust, oil mist, vibration, corrosive sulfur gas, conductive particles, and other harsh environments.
- ▲ IP54 drip-proof and dustproof options are also offered.\*  
\* Available soon

### RoHS

- ▲ All standard products are fully compliant with the EU's RoHS directive.



### Noise Reduction

- ▲ A1000 uses Yaskawa's Swing PWM function\* to suppress electromagnetic and audible motor noise, creating a more peaceful environment.  
\* Not available in models 450 kW and above.
- Comparing our former product line with our new Swing PWM feature

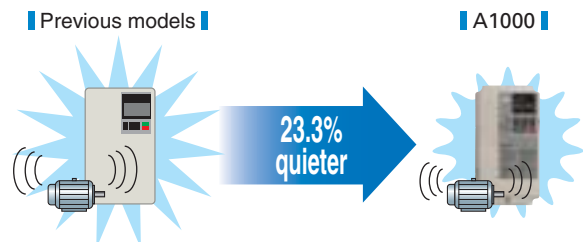

Note: Calculated by comparing peak values during noise generation

### Suppressing Power Supply Harmonics

- ▲ A DC reactor minimizes harmonic distortion, standard on drives 22 kW and above.

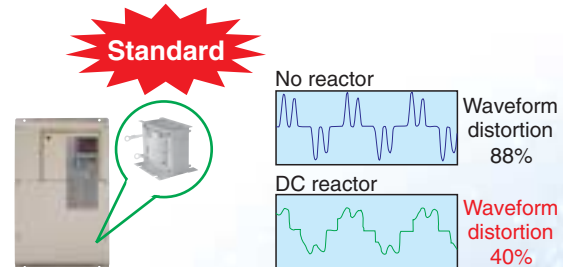

- ▲ Optional features available soon for compatibility with 12-pulse and 18-pulse rectifiers.\*  
\* Requires a separate 3-winding or 4-winding transformer.
- ▲ Filter option available soon to suppress harmonic distortion.

# Safety

## Safety Regulations

- ▲ All models have a Safe Disable function to stop the motor in accordance with EN954-1 safety category 3, IEC/EN61508 SIL2 requirements.
- ▲ An External Device Monitor (EDM) function has also been added to monitor the safety status of the drive.

● **Safe Disable example: Door switch circuit**

A1000 is equipped with 2 input terminals and a single output terminal for connecting a safe disable device.

Input: Triggered when either terminal H1 or H2 opens.

Output: EDM output monitors the safety status of the drive.

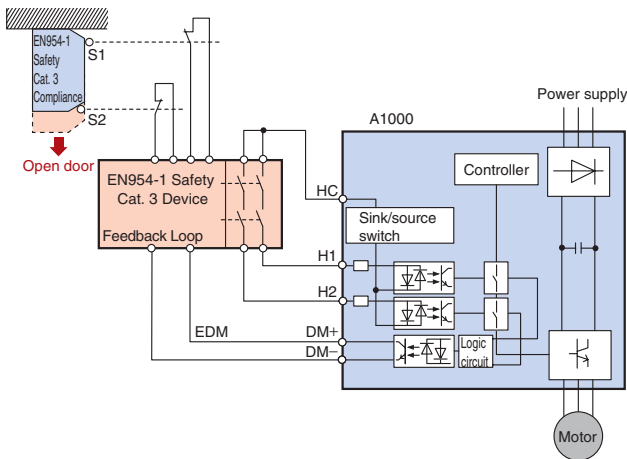

## Controlled Stop Despite Power Loss

- ▲ Should a power outage occur, A1000 can bring the application to controlled stop quickly and safely using the KEB function.\*

\* Under development for models 450 kW and above.

● **Quickly ramp to stop with KEB function**

**Applications**

Perfect for spindle drive application and film production lines where stopping methods are crucial to the application to reduce production cost.

■ **Previous model**

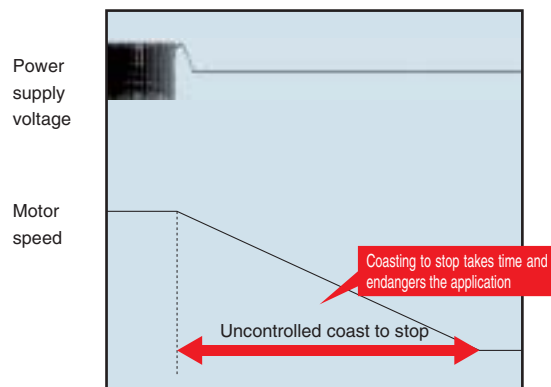

■ **A1000**

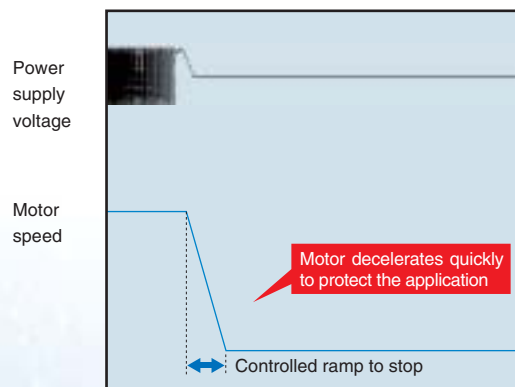

The Answer is  
**A1000**

# A

## Transforming the Application Installation with Unparalleled Performance

### Even More and More Compact

▲ Yaskawa continues to make applications even smaller by combining the world's smallest drive in its class with the light, efficient design of a synchronous motor.

● Comparing drive dimensions

Example: 400 V Class 75 kW

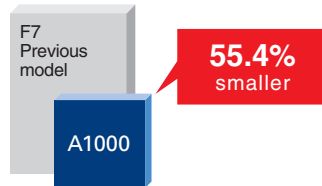

● Comparing motor dimensions

Example: 200 V 3.7 kW motor



▲ Use Side-by-Side installation\* for an even more compact setup.

\* For models up to 18.5 kW.

▲ Finless models\* also available.

\* For release soon

### Customize Your Drive

▲ DriveWorksEZ visual programming tool with all models

Simply drag and drop icons to completely customize your drive. Create special sequences and detection functions, then load them onto the drive.

● Program a customized sequence

Example: Positioning control without a motor encoder

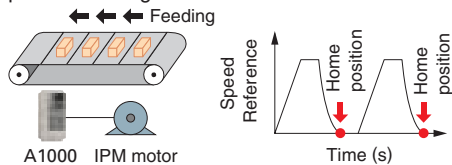

● Create customized detection features

Example: Machine weakening analysis using torque pulse detection

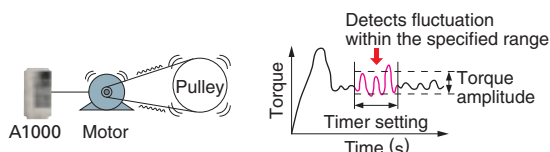

▲ USB for connecting to a PC

● USB port lets the drive connect to a PC



Note: Drives are also equipped with an RJ-45 comm. port that takes the existing WV103 cable used in Yaskawa's previous models. Simply remove the operator keypad for the RJ-45 connector.

▲ Dual Rating allows for an even more compact setup  
Each drive lets the user choose between Normal Duty or Heavy Duty operation. Depending on the application, A1000 can run a motor an entire frame size larger than our previous model.

● Select the drive rating that best fits the application needs

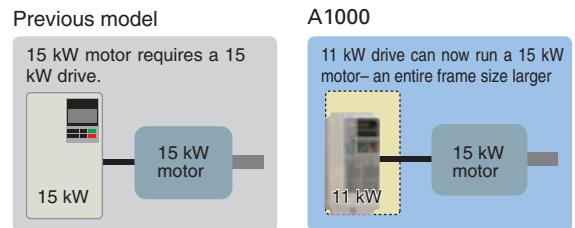

Dual Ratings in A1000

A single parameter lets the user set the drive for Normal Duty or Heavy Duty

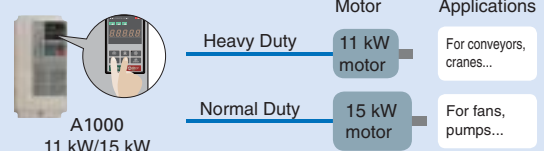

Note: Always select a drive with a current rating greater than the motor rated current.

### Breeze-Easy Setup

▲ Immediate setup with Application Presets

A1000 automatically sets parameters needed for most major applications. Simply selecting the appropriate application instantly optimizes the drive for top performance, saving enormous time setting up for a trial run.



● Example using Application Presets

Selecting "Conveyor" optimizes five parameter settings so the drive is ready to start running your conveyor application immediately.



Setting	Application	Parameters are programmed automatically
00	General-purpose	
01	Water Supply Pump	
02	Conveyor	A1-02 Control mode selection
03	Exhaust Fan	C1-01 Accel Time 1
04	HVAC Fan	C1-02 Decel Time 1
05	Air Compressor	
06	Crane (Hoist)	C6-01 ND/HD Selection
07	Crane (Traverse)	



## Variety of Braking Functions

- ▲ Overexcitation deceleration brings the motor to an immediate stop without the use of a braking resistor.
- ▲ All models up to 30 kW are equipped with a braking transistor for even more powerful braking options by just adding a braking resistor.

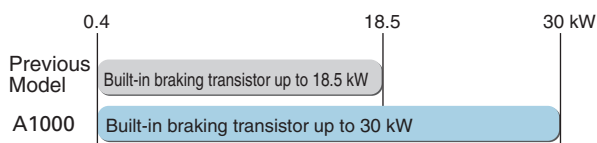

## All Major Serial Network Protocols

- ▲ RS-422/485 (MEMOBUS/Modbus at 115.2 kbps) standard on all models.
- ▲ Option cards available for all major serial networks used across the globe: PROFIBUS-DP, DeviceNet, CC-Link, CANopen, LONWORKS\*, MECHATRO-LINK-II, among others.  
\* Available soon  
Note: Registered trademarks of those companies.
- ▲ Less wiring and space-saving features make for easy installation and maintenance.

## Long Life Performance

### Ten Years of Durable Performance

- ▲ Cooling fan, capacitors, relays, and IGBTs have been carefully selected and designed for a life expectancy up to ten years.\*  
\* Assumes the drive is running continuously for 24 hours a day at 80% load with an ambient temperature of 40°C.

### Motor Life

- ▲ Thanks to relatively low copper loss in the rotor and a cool shaft during operation, synchronous motors have a bearing life twice that of induction motors.

### Performance Life Monitors

- ▲ Yaskawa's latest drive series is equipped with performance life monitors that notify the user of part wear and maintenance periods to prevent problems before they occur.
- Drive outputs a signal to the control device indicating components may need to be replaced

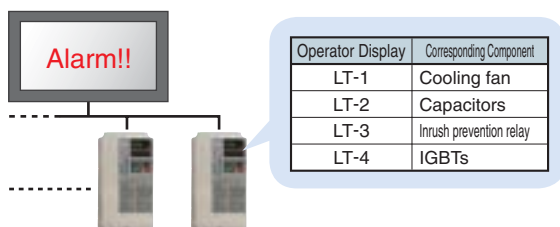

## Easy Maintenance

### The First Terminal Board with a Parameter Backup Function

- ▲ The terminal block's ability to save parameter setting data makes it a breeze to get the application back on-line in the event of a failure requiring drive replacement.

#### ● A1000 Terminal Block

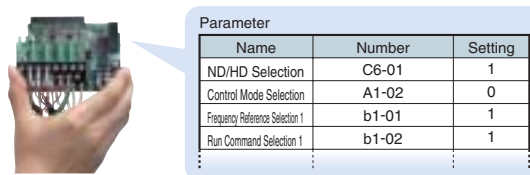

### Engineering Tool DriveWizard Plus

- ▲ Manage the unique settings for all your drives right on your PC.
- ▲ An indispensable tool for drive setup and maintenance. Edit parameters, access all monitors, create customized operation sequences, and observe drive performance with the oscilloscope function.
- ▲ The Drive Replacement feature in DriveWizard Plus saves valuable time during equipment replacement and application upgrades by converting previous Yaskawa product parameter values to the new A1000 parameters automatically.

#### ● Drive Replacement Function

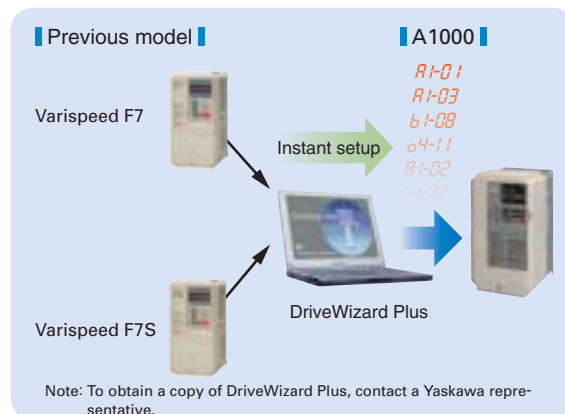

### Parameter Copy Function

- ▲ All standard models are equipped with a Parameter Copy function using the keypad that allows parameter settings to be easily copied from the drive or uploaded for quick setup.
- ▲ A USB Copy Unit is also available as an even faster, more convenient way to back up settings and instantly program the drive.

# Features for Every Application

A1000 is loaded with functions to match the particular needs of every application.



## Cranes

### Advantages

#### 1 Application Presets

Selecting “Crane” from A1000’s Application Presets automatically programs A1000 for optimal performance with a crane application. Save valuable set-up time and start running immediately.

#### 2 Switch Between Motors

Use the same drive to control one motor for hoisting, another motor for traverse operation. Terminal inputs let the user set up a relay to switch back and forth between motors.

#### 3 Powerful Starting Torque

Powerful torque at low speeds ensures the power needed for the application and prevents problems with slipping.

#### 4 Safety Functions

The Safe Disable function comes standard for compliance with various safety regulations.

#### 5 Visual Programming with DriveWorksEZ

Easily customize the drive using a PC.

#### 6 Performance Life Diagnostic Features

A1000 notifies the user or controller when maintenance may be required for certain components such as the cooling fan or capacitors.

#### 7 Terminal Block with Parameter Backup Function



The terminal block can be transferred to a new drive keeping all terminal wiring intact, and built-in memory backs up all parameter settings. An incredible time saver when replacing a drive.

### Functions

<small>NEW</small> Application Presets	Motor 2 Switch	<small>NEW</small> IM/PM Switch
Torque Limit	<small>NEW</small> Overexcitation Braking	<small>NEW</small> Drive WorksEZ
Current Vector Control	Speed Search Function	Zero Servo Function
<small>NEW</small> Maintenance Monitors	Accel/Decel Time Switch	Torque Detection
KEB Function		

NEW FUNCTIONS Indicates a new function in A1000

### Applications

	
Hoist, Crane	Shutter Door



## Fans and Pumps

### Advantages

#### 1 Application Presets

Selecting "Fan" or "Pump" from A1000's Application Presets automatically programs A1000 for optimal performance specific for those applications. Save valuable setup time and start running immediately.

#### 2 Compact Design

- Yaskawa offers a compact solution for both drive and motor.
- Dual ratings
- Selecting Normal Duty makes it possible to use a smaller drive.
- Combine with a synchronous motor
- Run a synchronous motor instead of an induction motor for an even more compact installation.

#### 3 Astounding Efficiency

Combine A1000 with a synchronous motor and save on energy costs.

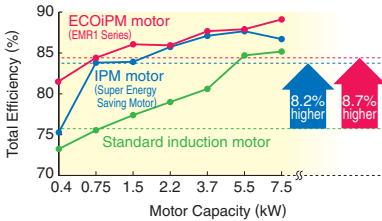

#### 4 Output Power Pulse Monitor

Pulse output feature can send a signal to the PLC to keep track of kilowatt hours. No extra power meter needed.  
Note: Cannot legally be used as proof of power consumption.

#### 5 Speed Search

Yaskawa's unique speed search functions easily carry the motor through momentary power loss. No back-up power supply needed to keep the entire application running smoothly.

#### 6 24 V Control Power Supply Option

Lets the user monitor drive data from a PLC even when the power goes out.

#### 7 Terminal Block with Parameter Backup Function

The terminal block can be transferred to a new drive keeping all terminal wiring intact, and built-in memory backs up all parameter settings. An incredible time saver when replacing a drive.

#### 8 Performance Life Diagnostic Features

A1000 notifies the user or controller when maintenance may be required for certain components such as the cooling fan or capacitors.

#### 9 Low Harmonic Distortion

DC reactor comes standard on all model above 22 kW to minimize harmonic distortion. This built-in feature saves space and wiring.

### Functions

<small>NEW</small> Application Presets	<small>NEW</small> IM/PM Switch	Momentary Power Loss Ride-Thru
<small>NEW</small> Overexcitation Braking	<small>NEW</small> Watt-Hour Pulse Monitor	Frequency Reference Loss
Accel/Decel Time Switch	Energy Saving	Fault Restart
Speed Search	<small>NEW</small> Drive WorksEZ	Overvoltage Suppression
Frequency Jump	PID Control	<small>NEW</small> Overload Fault Prevention
Frequency Reference Hold	Torque Detection	<small>NEW</small> Maintenance Monitors

NEW Functions Indicates a new function in A1000

### Applications

		
HVAC	Fan	Pump

# Features for Every Application

A1000 is loaded with functions to match the particular needs of every application.



## Metal Working

### Advantages

- 1 KEB Function**  
 The KEB function can quickly decelerate the motor to stop in case of a power outage, rather than putting equipment at risk by simply allowing the motor to coast. Easy to program to match application needs.
- 2 Overvoltage Suppression**  
 Particularly beneficial for die cushion and other press-type machinery, overvoltage suppression prevents faults and keeps the application running.
- 3 Visual Programming with DriveWorksEZ**  
 Easily customize the drive using a PC.
- 4 Safety Functions**  
 Safe Disable feature comes standard for compliance with various safety regulations.
- 5 Current Vector Control**  
 Protect connected machinery by controlling torque directly through torque detection and torque limits offered by current vector control.
- 6 Performance Life Diagnostic Features**  
 A1000 notifies the user or controller when maintenance may be required for certain components such as fan or capacitors.
- 7 Terminal Block with Parameter Backup Function**  
 The terminal block can be transferred to a new drive keeping all terminal wiring intact, and built-in memory backs up all parameter settings. An incredible time saver when replacing a drive.

### Functions

KEB Function	<b>NEW</b> Overexcitation Braking	Pulse Train Input
Fault Restart	Speed Search	Pulse Train Output
Overvoltage Suppression	Dwell Function	Torque Detection
<b>NEW</b> Overload Fault Prevention	Current Vector Control	Torque Limit
<b>NEW</b> Maintenance Monitors	<b>NEW</b> Drive WorksEZ	Zero Servo Function

**NEW** Functions Indicates a new function in A1000

### Applications



Press



Machine Tool



## Conveyor Systems

Advantages

- 1 Application Presets**  
 Selecting "Conveyor" from A1000's Application Presets presets automatically programs A1000 for optimal performance specific for those applications. Save valuable setup time and start running immediately.
- 2 Safety Functions**  
 Safe Disable feature comes standard for compliance with various safety regulations.
- 3 Astounding Efficiency**  
 Combine A1000 with a synchronous motor to save on energy costs. Save further but still maintain high performance by eliminating the motor encoder.
- 4 Overexcitation Braking**  
 Bring the motor to an immediate stop without the use of a braking resistor (IM motors only).
 

Normal Deceleration

→

Overexcitation Deceleration

Note: Varies in accordance with motor specifications and load.
- 5 Visual Programming with DriveWorksEZ**  
 Easily customize the drive using a PC.
- 6 24 V Control Power Supply Option**  
 Lets the user monitor drive data from a PLC even when the main power is removed.
- 7 Verify Menu**  
 Quickly reference any settings that have been changed from their original default values.
 

Changed Value			
Name	Parameter	Default	Set Value
Frequency Ref. Selection1	b1-01	1	0
Acceleration Time1	C1-01	10.00 s	15.00 s
Deceleration Time1	C1-02	10.00 s	15.00 s
⋮	⋮	⋮	⋮
- 8 Performance Life Diagnostic Features**  
 A1000 notifies the user or controller when maintenance may be required for certain components such as fan or capacitors.
- 9 Low Harmonic Distortion**  
 DC reactor comes standard on all model above 22 kW to minimize harmonic distortion. This built-in feature saves space and wiring.

### Functions

NEW Application Presets

NEW Drive WorksEZ

Current Vector Control

NEW Overexcitation Braking

PID Control

NEW Torque Limit

Droop Control

Pulse Train Input

Zero Servo Function

NEW IM/PM Switch

Pulse Train Output

Fault Restart

NEW Online Tuning

Torque Detection

NEW Maintenance Monitors

NEW Functions Indicates a new function in A1000

### Applications

Conveyor

# Product Lineup

Motor Capacity (kW)	Three-Phase 200 V				Three-Phase 400 V			
	Normal Duty		Heavy Duty		Normal Duty		Heavy Duty	
	Model	Rated Output	Model	Rated Output	Model	Rated Output	Model	Rated Output
0.4			CIMR-AA2A0004	3.2 A			CIMR-AA4A0002	1.8 A
0.75	CIMR-AA2A0004	3.5 A	CIMR-AA2A0006	5 A	CIMR-AA4A0002	2.1 A	CIMR-AA4A0004	3.4 A
1.1	CIMR-AA2A0006	6 A	CIMR-AA2A0008*	6.9 A				
1.5	CIMR-AA2A0008*	8 A	CIMR-AA2A0010	8 A	CIMR-AA4A0004	4.1 A	CIMR-AA4A0005	4.8 A
2.2	CIMR-AA2A0010	9.6 A	CIMR-AA2A0012	11 A	CIMR-AA4A0005	5.4 A	CIMR-AA4A0007	5.5 A
3.0	CIMR-AA2A0012	12 A	CIMR-AA2A0018*	14 A	CIMR-AA4A0007	6.9 A	CIMR-AA4A0009	7.2 A
3.7	CIMR-AA2A0018*	17.5 A	CIMR-AA2A0021	17.5 A	CIMR-AA4A0009	8.8 A	CIMR-AA4A0011	9.2 A
5.5	CIMR-AA2A0021	21 A	CIMR-AA2A0030	25 A	CIMR-AA4A0011	11.1 A	CIMR-AA4A0018	14.8 A
7.5	CIMR-AA2A0030	30 A	CIMR-AA2A0040	33 A	CIMR-AA4A0018	17.5 A	CIMR-AA4A0023	18 A
11	CIMR-AA2A0040	40 A	CIMR-AA2A0056	47 A	CIMR-AA4A0023	23 A	CIMR-AA4A0031	24 A
15	CIMR-AA2A0056	56 A	CIMR-AA2A0069	60 A	CIMR-AA4A0031	31 A	CIMR-AA4A0038	31 A
18.5	CIMR-AA2A0069	69 A	CIMR-AA2A0081	75 A	CIMR-AA4A0038	38 A	CIMR-AA4A0044	39 A
22	CIMR-AA2A0081	81 A	CIMR-AA2A0110	85 A	CIMR-AA4A0044	44 A	CIMR-AA4A0058	45 A
30	CIMR-AA2A0110	110 A	CIMR-AA2A0138	115 A	CIMR-AA4A0058	58 A	CIMR-AA4A0072	60 A
37	CIMR-AA2A0138	138 A	CIMR-AA2A0169	145 A	CIMR-AA4A0072	72 A	CIMR-AA4A0088	75 A
45	CIMR-AA2A0169	169 A	CIMR-AA2A0211	180 A	CIMR-AA4A0088	88 A	CIMR-AA4A0103	91 A
55	CIMR-AA2A0211	211 A	CIMR-AA2A0250	215 A	CIMR-AA4A0103	103 A	CIMR-AA4A0139	112 A
75	CIMR-AA2A0250	250 A	CIMR-AA2A0312	283 A	CIMR-AA4A0139	139 A	CIMR-AA4A0165	150 A
90	CIMR-AA2A0312	312 A	CIMR-AA2A0360	346 A	CIMR-AA4A0165	165 A	CIMR-AA4A0208	180 A
110	CIMR-AA2A0360	360 A	CIMR-AA2A0415	415 A	CIMR-AA4A0208	208 A	CIMR-AA4A0250	216 A
	CIMR-AA2A0415	415 A						
132					CIMR-AA4A0250	250 A	CIMR-AA4A0296	260 A
160					CIMR-AA4A0296	296 A	CIMR-AA4A0362	304 A
185					CIMR-AA4A0362	362 A	CIMR-AA4A0414	370 A
220					CIMR-AA4A0414	414 A	CIMR-AA4A0515	450 A
250					CIMR-AA4A0515	515 A		
315							CIMR-AA4A0675	605 A
355					CIMR-AA4A0675	675 A		
450							CIMR-AA4A0930	810 A
500					CIMR-AA4A0930	930 A		
560							CIMR-AA4A1200	1090A
630					CIMR-AA4A1200	1200 A		

## Model Number Key

\* Available in Japan only

CIMR- A A 2 A 0004 F A A

AC Drive A1000 Series      Design Revision Order

No.	Region Code	No.	Voltage Class	No.	Customized Specifications	No.	Output Current A	No.	Enclosure Type	No.	Environmental Specifications		
T	Asia	2	3-phase, 200-240 Vac	A	Standard model		Note: See chart above.	A	IP00	A	Standard	N	Oil
A	Japan	4	3-phase, 380-480 Vac					F	NEMA Type1	C	Salt resistant	P	Moisture, dust, vibration
										K	Gas	R	Gas, vibration
										M	Humidity, dust	S	Shock, vibration
												T	Oil, vibration

Note: Contact a Yaskawa representative for more on environmental specifications.

# Model Selection

## Optimizing Control for Each Application

A1000 offers two separate performance ratings: Normal Duty and Heavy Duty.

Heavy Duty is capable of creating more powerful torque, while Normal Duty allows the drive to operate a larger motor.

Difference between load ratings:

	Normal Duty Rating	Heavy Duty Rating
Parameter settings	C6-01=1	C6-01=0 (default)
Overload tolerance	120% for 60 s	150% for 60 s
Carrier frequency	Low carrier frequency (Swing PWM)*	Low carrier frequency

\* Use Swing PWM to quiet undesirable motor noise generated when operating with a low carrier frequency.

Not available in models 450 kW and above.

### Normal Duty Applications

#### ● Applications



#### ● Selecting a Drive

For a fan application using a 11 kW motor, select CIMR-AA2A0040 and set it for Normal Duty performance (C6-01 = 1).

Model: CIMR-AA2A0040

Normal Duty: 11 kW

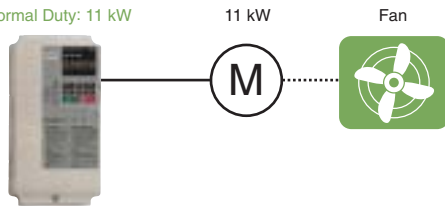

### Heavy Duty Applications

#### ● Applications

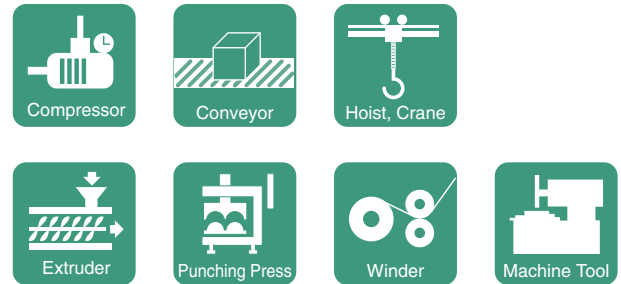

#### ● Selecting a Drive

For a conveyor application using an 11 kW motor, select CIMR-AA2A0056 and set it for Heavy Duty performance (default).

Model: CIMR-AA2A0056

Heavy Duty: 11 kW

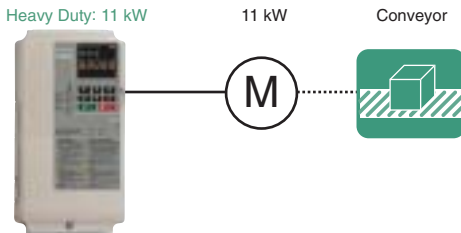

Use the table below to transition from Varispeed F7 and Varispeed F7S to the A1000 series.

Power Supply	200 V						400 V		
	Model	Varispeed F7	Varispeed F7S	A1000	Varispeed F7	Varispeed F7S	A1000		
Applicable Motor		CIMR-F7A2	CIMR-F7S2	CIMR-AA2A	CIMR-F7A4	CIMR-F7S4	CIMR-AA4A		
	Max. Applicable Motor Capacity (kW)	Induction Motor	Synchronous Motor	Induction Motor Synchronous Motor	Induction Motor	Synchronous Motor	Induction Motor Synchronous Motor		
0.4	0P4	0P4	0P4	0004	0P4	0P4	0002		
0.75	0P7	0P7	0P7	0006	0P7	0P7	0004		
1.5	1P5	1P5	1P5	0010	1P5	1P5	0005		
2.2	2P2	2P2	2P2	0012	2P2	2P2	0007		
3.7	3P7	3P7	3P7	0021	3P7	3P7	0011		
5.5	5P5	5P5	5P5	0030	5P5	5P5	0018		
7.5	7P5	7P5	7P5	0040	7P5	7P5	0023		
11	011	011	011	0056	011	011	0031		
15	015	015	015	0069	015	015	0038		
18.5	018	018	018	0081	018	018	0044		
22	022	022	022	0110	022	022	0058		
30	030	030	030	0138	030	030	0072		
37	037	037	037	0169	037	037	0088		
45	045	045	045	0211	045	045	0103		
55	055	055	055	0250	055	055	0139		
75	075	075	075	0312	075	075	0165		
90	090	-	-	0360	090	090	0208		
110	110	-	-	0415	110	110	0250		
132	-	-	-	-	132	132	0296		
160	-	-	-	-	160	160	0362		
185	-	-	-	-	185	220	0414		
220	-	-	-	-	220	300	0515		
315	-	-	-	-	300	300	0675		

# Software Functions

Loaded with software functions just right for your application.



New software available to upgrade from F7 to A1000, automatically matching function and sequence settings.

Note: Major functions listed below.

NEW

Application Presets

No need to struggle with difficult parameters and complex calculations. Parameters are set instantly simply by selecting the appropriate Application Preset.

## Functions at Start and Stop

NEW

Optimal Deceleration

**Optimal deceleration without needing to set the deceleration time.**

Drive slows the application smoothly controlling DC bus voltage.

NEW

Overexcitation Braking

**Perfect for applications with high load inertia that rarely need to be stopped.**

Stop quickly: 50% faster without the use of a braking resistor.

Note: Stopping times may vary based on motor characteristics.

Speed Search

**Start a coasting motor.**

Automatically brings a coasting motor back to the target frequency without using a motor encoder.

Dwell Function

**Accelerate and decelerate smoothly with large inertia loads.**

Drive prevents speed loss by holding the output frequency at a constant level during acceleration and deceleration.

Accel/Decel Time Switch

**Switch easily between accel/decel times.**

Switch acceleration and deceleration rates when running two motors from the same drive, or assign specific accel/decel rates when operating at high speed or at low speed.

## Reference Functions

Frequency Reference Upper/Lower Limits

**Limit motor speed.**

Set speed limits and eliminate the need for extra peripheral devices and extraneous hardware.

Frequency Jump

**Skip over troublesome resonant frequencies.**

Drive can be programmed to avoid machine resonance problems by avoiding constant speed operation at certain speeds.

Frequency Reference Hold

**Improved operability.**

Momentarily hold the operating frequency during acceleration or deceleration as the load is lowered or raised.

Droop Control

**Balances the load automatically between motors.**

Calculates the ratio of the load torque and adjusts motor speed accordingly.

## Functions for Top Performance

NEW

IM/PM Switch

**Run both IM and PM motors with a single drive.** The most advanced motor drive technology can run both IM and PM motors\*, allowing for even greater energy savings and a more compact setup.

\* Currently developing PM motor compatibility for drives 450 kW and above.

NEW

Watt-Hour Pulse Monitor

**No extra watt hour meter needed.**

A pulse output lets the user monitor power consumption.\*

\* Cannot legally be used as proof of power consumption.

Energy Saving

**Automatically runs at top efficiency.\***

The drive supplies voltage to the motor relative to the speed and load so that the application is for operating at the most efficient level.

\* Not available in models 450 kW and above.

NEW

Online Tuning

**Enables high-precision operation.**

Automatically adjusts resistance between motor conductors during operation, thus improving speed accuracy when there are motor temperature fluctuations. This function is active only for Open Loop Vector Control.

Current Vector Control

**Achieve high levels of performance.**

The drive comes with current vector control capabilities for high performance applications.

NEW

Drive WorksEZ

**Customize the perfect drive to fit your needs.**

Upper controller circuitry and drive I/O terminals can be programmed so that extra hardware is no longer needed. Drag-and-drop. Visual programming makes customization a breeze.

PID Control

**Automatic PID control.**

The internal PID controller fine-tunes the output frequency for precise control of pressure, flow, or other variables.

Motor 2 Switch

**One drive runs two motors.**

Use a single drive to operate two different motors. Only one PM motor may be used.

Pulse Train Input

**Improved operability.**

Use the Pulse Train Input to control not only the frequency reference, but also PID feedback and PID input.

Pulse Train Output

**Improved monitor functions.**

Pulse output lets the user observe everything from the frequency reference and out-



put frequency to motor speed, softstart output frequency, PID feedback, and PID input.

**Torque Detection****Protects the load and helps ensure continuous operation.**

An output terminal is triggered when motor torque rises above or falls below a specified level. Useful as an interlock signal for protecting equipment when blade problems arise in a machine tool application or for detecting a broken belt.

**Torque Limit****Better reliability: Keep the application running while protecting the load.**

A1000 helps protect your application by restricting the amount of torque the motor can create.

**Torque Control****Freely adjust torque levels with an external reference signal.**

Perfect for tension control in winders and assisting torque followers.

**Feed Forward Control****Optimizes speed changes when working with high-inertia loads.**

Estimates the acceleration/deceleration torque required for the change in speed, and then recalculates the torque reference.

NEW

**Inertia Tuning****Automatically optimize ASR settings for superior responsiveness.\***

Optimizes the drive's ability to decelerate the load. Useful for applications using KEB and Feed Forward functions.

\* Not available in models 450 kW and above.

**Speed Search Function****Automatically switches to line power.**

Switches operation between line power and inverter drive operation without stopping the motor.

**Timer Function****No need for extra hardware.**

Control timing by opening and closing the output signal relative to the input signal.

**Zero Servo Control****Locks the motor at zero speed.**

Holds the motor solidly at 0 Hz, regardless of external influences on the load.

NEW

**Carrier Frequency****Set the carrier frequency to best match application needs.**

Reduces noise and resonance in the both the motor as well as the mechanical system. The Swing PWM feature\* can be used to minimize audible motor noise.

\* Not available in models 450 kW and above.

**Continuous Run during Reference Loss****Keeps the application running.**

Maintains continuous operation even if the controller fails or frequency reference is lost. An indispensable feature for large HVAC applications.

**Fault Restart****Keep running when a fault occurs.**

A1000 has full self-diagnostic features and can restart the application in the event of a fault. Up to 10 restarts possible.

**Protective Functions****Momentary Power Loss Ride-Thru****Keep running even during a momentary loss in power.**

A1000 automatically restarts the motor and keeps the application going in the event of a power loss.

**Overvoltage Suppression****Avoid overvoltage trip.**

Effective for punching presses and crank shafts where repetitive motion creates large amounts of regenerative energy. The drive increases or decreases the frequency in correspondence with regen levels to prevent overvoltage from occurring.

NEW

**Overload Fault Prevention****Prevents overload faults to keep the application running at all times.**

Ensures continuous operation during sudden changes in the load that may briefly rise above overload levels and would otherwise shut the application down.

**Load Speed Display****Monitor actual speed of the motor and load.**

Monitors let the user keep track of motor rotations and line speed.

**Copy Function****Save parameter setting to the digital operator.**

Copy all parameter settings to the operator keypad, and then transfer those settings to another drive. Saves valuable setup and maintenance time.

NEW

**Maintenance Monitors****Notifies the user when maintenance may be required.**

An output signal is triggered when certain components such as the cooling fan or capacitors are nearing their expected performance life.

**KEB Function****Decelerate to stop when the power goes out.\***

A1000 uses regenerative energy from the motor to bring the application to a stop, rather than simply letting it coast.

\* Currently under development for models 450 kW and above.



# Parameter List

Refer to the A1000 Technical Manual for details.

Function	No.	Name	Range	Default	Changes during Run	
Initialization Parameters	A1-00	Language Selection	0 to 7	1*1	○	
	A1-01	Access Level Selection	0 to 2	2*2	○	
	A1-02	Control Method Selection	0,1,2,3,5,6,7*9	2*1	×	
	A1-03	Initialize Parameters	0 to 5550	0	×	
	A1-04	Password	0 to 9999	0	×	
	A1-05	Password Setting	0 to 9999	0	×	
	A1-06	Application Preset	0 to 7	0	×	
	A1-07	DWEZ Function Selection	0 to 2	0	×	
User Parameters	A2-01 to A2-32	User Parameters, 1 to 32	b1-01 to o2-08	*2	×	
	A2-33	User Parameter Automatic Selection	0, 1	1*2	×	
Operation Mode Selection	b1-01	Frequency Reference Selection 1	0 to 4	1	×	
	b1-02	Run Command Selection 1	0 to 3	1	×	
	b1-03	Stopping Method Selection	0 to 3*3	0	×	
	b1-04	Reverse Operation Selection	0, 1	0	×	
	b1-05	Action Selection below Minimum Output Frequency	0 to 3	0	×	
	b1-06	Digital Input Reading	0, 1	1	×	
	b1-07	LOCAL/REMOTE Run Selection	0, 1	0	×	
	b1-08	Run Command Selection while in Programming Mode	0 to 2	0	×	
	b1-14	Phase Order Selection	0, 1	0	×	
	b1-15	Frequency Reference Selection 2	0 to 4	0	×	
	b1-16	Run Command Selection 2	0 to 3	0	×	
	b1-17	Run Command at Power Up	0, 1	0	×	
	DC Injection Braking and Short Circuit Braking	b2-01	DC Injection Braking Start Frequency	0.0 to 10.0	*3	×
		b2-02	DC Injection Braking Current	0 to 100	50%	×
		b2-03	DC Injection Braking Time at Start	0.00 to 10.00	0.00 s	×
		b2-04	DC Injection Braking Time at Stop	0.00 to 10.00	*3	×
		b2-08	Magnetic Flux Compensation Capacity	0 to 1000	0%	×
b2-12		Short Circuit Brake Time at Start	0.00 to 25.50	0.00 s	×	
b2-13		Short Circuit Brake Time at Stop	0.00 to 25.50	0.50 s	×	
b2-18		Short Circuit Braking Current	0.0 to 200.0	100.0%	×	
Speed Search	b3-01	Speed Search Selection at Start	0, 1	*3	×	
	b3-02	Speed Search Deactivation Current	0 to 200	*3	×	
	b3-03	Speed Search Deceleration Time	0.1 to 10.0	2.0 s	×	
	b3-04	V/f Gain during Speed Search	10 to 100	*4	×	
	b3-05	Speed Search Delay Time	0.0 to 100.0	0.2 s	×	
	b3-06	Output Current 1 during Speed Search	0.0 to 2.0	*4	×	
	b3-10	Speed Search Detection Compensation Gain	1.00 to 1.20	1.05	×	
	b3-14	Bi-Directional Speed Search Selection	0, 1	*3	×	
	b3-17	Speed Search Restart Current Level	0 to 200	150%	×	
	b3-18	Speed Search Restart Detection Time	0.00 to 1.00	0.10 s	×	
	b3-19	Number of Speed Search Restarts	0 to 10	3	×	
Delay Timer	b4-01	Timer Function On-Delay Time	0.0 to 3000.0	0.0 s	×	
	b4-02	Timer Function Off-Delay Time	0.0 to 3000.0	0.0 s	×	
	PID Control	b5-01	PID Function Setting	0 to 4	0	×
		b5-02	Proportional Gain Setting (P)	0.00 to 25.00	1.00	○
		b5-03	Integral Time Setting (I)	0.0 to 360.0	1.0 s	○
		b5-04	Integral Limit Setting	0.0 to 100.0	100.0%	○
b5-05		Derivative Time (D)	0.00 to 10.00	0.00 s	○	
b5-06		PID Output Limit	0.0 to 100.0	100.0%	○	
b5-07		PID Offset Adjustment	-100.0 to 100.0	0.0%	○	
b5-08		PID Primary Delay Time Constant	0.00 to 10.00	0.00 s	○	
b5-09		PID Output Level Selection	0, 1	0	×	
b5-10		PID Output Gain Setting	0.00 to 25.00	1.00	×	
b5-11	PID Output Reverse Selection	0, 1	0	×		
b5-12	PID Feedback Loss Detection Selection	0 to 5	0	×		
b5-13	PID Feedback Low Detection Level	0 to 100	0%	×		
b5-14	PID Feedback Low Detection Time	0.0 to 25.5	1.0 s	×		
b5-15	PID Sleep Function Start Level	0.0 to 400.0	0.0 Hz	×		

Note: Footnotes are listed on page 23.

Function	No.	Name	Range	Default	Changes during Run	
PID Control	b5-16	PID Sleep Delay Time	0.0 to 25.5	0.0 s	×	
	b5-17	PID Accel/Decel Time	0 to 6000.0	0.0 s	×	
	b5-18	PID Setpoint Selection	0, 1	0	×	
	b5-19	PID Setpoint Value	0.00 to 100.00	0.00%	×	
	b5-20	PID Setpoint Scaling	0 to 3	1	×	
	b5-34	PID Output Lower Limit	-100.0 to 100.0	0.0%	○	
	b5-35	PID Input Limit	0.0 to 1000.0	1000.0%	○	
	b5-36	PID Feedback High Detection Level	0 to 100	100%	×	
	b5-37	PID Feedback High Detection Time	0.0 to 25.5	1.0 s	×	
	b5-38	PID Setpoint User Display	1 to 60000	dep. on b5-20	×	
	b5-39	PID Setpoint Display Digits	0 to 3	0	×	
	b5-40	Frequency Reference Monitor Content during PID	0, 1	0	×	
	Dwell/Function	b6-01	Dwell Reference at Start	0.0 to 400.0	0.0 Hz	×
		b6-02	Dwell Time at Start	0.0 to 10.0	0.0 s	×
b6-03		Dwell Frequency at Stop	0.0 to 400.0	0.0 Hz	×	
b6-04		Dwell Time at Stop	0.0 to 10.0	0.0 s	×	
Droop Control	b7-01	Droop Control Gain	0.0 to 100.0	0.0%	○	
	b7-02	Droop Control Delay Time	0.03 to 2.00	0.05 s	○	
Energy Saving *8	b8-01	Energy Saving Control Selection	0, 1	*3	×	
	b8-02	Energy Saving Gain	0.0 to 10.0	*3	○	
	b8-03	Energy Saving Control Filter Time Constant	0.00 to 10.00	*2	○	
	b8-04	Energy Saving Coefficient Value	0.00 to 655.00	*4 dep. on E2-11	×	
	b8-05	Power Detection Filter Time	0 to 2000	20 ms	×	
	b8-06	Search Operation Voltage Limit	0 to 100	0%	×	
Zero Servo	b9-01	Zero Servo Gain	0 to 100	5	×	
	b9-02	Zero Servo Completion Width	0 to 16383	10	×	
Acceleration and Deceleration Times	C1-01	Acceleration Time 1	0.0 to 6000.0*2	10.0 s	○	
	C1-02	Deceleration Time 1	0.0 to 6000.0*2	10.0 s	○	
	C1-03	Acceleration Time 2	0.0 to 6000.0*2	10.0 s	○	
	C1-04	Deceleration Time 2	0.0 to 6000.0*2	10.0 s	○	
	C1-05	Acceleration Time 3 (Motor 2 Accel Time 1)	0.0 to 6000.0*2	10.0 s	○	
	C1-06	Deceleration Time 3 (Motor 2 Decel Time 1)	0.0 to 6000.0*2	10.0 s	○	
	C1-07	Acceleration Time 4 (Motor 2 Accel Time 2)	0.0 to 6000.0*2	10.0 s	○	
	C1-08	Deceleration Time 4 (Motor 2 Decel Time 2)	0.0 to 6000.0*2	10.0 s	○	
	C1-09	Fast Stop Time	0.0 to 6000.0*2	10.0 s	×	
	C1-10	Accel/Decel Time Setting Units	0, 1	1	×	
	C1-11	Accel/Decel Time Switching Frequency	0.0 to 400.0	0.0 Hz	×	
S-Curve Characteristics	C2-01	S-Curve Characteristic at Accel Start	0.00 to 10.00	*3	×	
	C2-02	S-Curve Characteristic at Accel End	0.00 to 10.00	0.20 s	×	
	C2-03	S-Curve Characteristic at Decel Start	0.00 to 10.00	0.20 s	×	
	C2-04	S-Curve Characteristic at Decel End	0.00 to 10.00	0.00 s	×	
Slip Compensation	C3-01	Slip Compensation Gain	0.0 to 2.5	*3	○	
	C3-02	Slip Compensation Primary Delay Time	0 to 10000	*3	○	
	C3-03	Slip Compensation Limit	0 to 250	200%	×	
	C3-04	Slip Compensation Selection during Regeneration	0 to 2	0	×	
	C3-05	Output Voltage Limit Operation Selection	0, 1	0	×	
Torque Compensation	C3-21	Motor 2 Slip Compensation Gain	0.00 to 2.50	dep. on E3-01	○	
	C3-22	Motor 2 Slip Compensation Primary Delay Time	0 to 10000	dep. on E3-01	○	
	C3-23	Motor 2 Slip Compensation Limit	0 to 250	200%	×	
	C3-24	Motor 2 Slip Compensation Selection during Regeneration	0 to 2	0	×	
Torque Compensation	C4-01	Torque Compensation Gain	0.00 to 2.50	*3	(PM motor ×)	
	C4-02	Torque Compensation Primary Delay Time 1	0 to 60000	*3 *4	○	
	C4-03	Torque Compensation at Forward Start	0.0 to 200.0	0.0%	×	
	C4-04	Torque Compensation at Reverse Start	-200.0 to 0.0	0.0%	×	
	C4-05	Torque Compensation Time Constant	0 to 200	10 ms	×	
	C4-06	Torque Compensation Primary Delay Time 2	0 to 10000	150 ms	×	
	C4-07	Motor 2 Torque Compensation Gain	0.00 to 2.50	1.00	○	



Function	No.	Name	Range	Default	Changes during Run	
Automatic Speed Regulator (ASR)	C5-01	ASR Proportional Gain 1	0.00 to 300.00*3	*3	○	
	C5-02	ASR Integral Time 1	0.000 to 10.000	*3	○	
	C5-03	ASR Proportional Gain 2	0.00 to 300.00*3	*3	○	
	C5-04	ASR Integral Time 2	0.000 to 10.000	*3	○	
	C5-05	ASR Limit	0.0 to 20.0	5.0%	×	
	C5-06	ASR Primary Delay Time Constant	0.000 to 0.500	*3	×	
	C5-07	ASR Gain Switching Frequency	0.0 to 400.0	0.0 Hz	×	
	C5-08	ASR Integral Limit	0 to 400	400%	×	
	C5-12	Integral Value during Accel/Decel	0, 1	0	×	
	C5-17	Motor Inertia	0.0001 to 600.00	*2 dep. on E5-01	×	
	C5-18	Load Inertia Ratio	0.0 to 6000.0	1.0	×	
	C5-21	Motor 2 ASR Proportional Gain 1	0.00 to 300.00*3	dep. on E3-01	○	
	C5-22	Motor 2 ASR Integral Time 1	0.000 to 10.000	dep. on E3-01	○	
	C5-23	Motor 2 ASR Proportional Gain 2	0.00 to 300.00*3	dep. on E3-01	○	
	C5-24	Motor 2 ASR Integral Time 2	0.000 to 10.000	dep. on E3-01	○	
	C5-25	Motor 2 ASR Limit	0.0 to 20.0	5.0%	×	
	C5-26	Motor 2 ASR Primary Delay Time Constant	0.000 to 0.500	dep. on E3-01	×	
	C5-27	Motor 2 ASR Gain Switching Frequency	0.0 to 400.0	0.0 Hz	×	
	C5-28	Motor 2 ASR Integral Limit	0 to 400	400%	×	
	C5-32	Integral Operation during Accel/Decel for Motor 2	0, 1	0	×	
	C5-37	Motor 2 Inertia	0.0001 to 600.00	*2	×	
	C5-38	Motor 2 Load Inertia Ratio	0.0 to 6000.0	1.0	×	
	Carrier Frequency	C6-01	Drive Duty Selection	0, 1	0	×
		C6-02	Carrier Frequency Selection	1 to F	*2	×
		C6-03	Carrier Frequency Upper Limit	1.0 to 15.0	*2	×
		C6-04	Carrier Frequency Lower Limit	1.0 to 15.0	*2	×
		C6-05	Carrier Frequency Proportional Gain	0 to 99	*2	×
		C6-09	Carrier Frequency during Rotational Auto-Tuning	0, 1	0	×
	Frequency Reference	d1-01	Frequency Reference 1	0.00 to 400.00*2*3	0.00 Hz	○
		d1-02	Frequency Reference 2			○
		d1-03	Frequency Reference 3			○
		d1-04	Frequency Reference 4			○
		d1-05	Frequency Reference 5			○
		d1-06	Frequency Reference 6			○
		d1-07	Frequency Reference 7			○
		d1-08	Frequency Reference 8			○
		d1-09	Frequency Reference 9			○
		d1-10	Frequency Reference 10			○
d1-11		Frequency Reference 11	○			
d1-12		Frequency Reference 12	○			
d1-13		Frequency Reference 13	○			
d1-14		Frequency Reference 14	○			
d1-15		Frequency Reference 15	○			
d1-16		Frequency Reference 16	○			
d1-17		Jog Frequency Reference	0.00 to 400.00*2*3			6.00 Hz
Frequency Upper/Lower Limits	d2-01	Frequency Reference Upper Limit	0.0 to 110.0	100.0%	×	
	d2-02	Frequency Reference Lower Limit	0.0 to 110.0	0.0%	×	
	d2-03	Master Speed Reference Lower Limit	0.0 to 110.0	0.0%	×	

Note: Footnotes are listed on page 23.

Function	No.	Name	Range	Default	Changes during Run
Jump Frequency	d3-01	Jump Frequency 1	0.0 to 400.0	0.0 Hz	×
	d3-02	Jump Frequency 2			×
	d3-03	Jump Frequency 3			×
	d3-04	Jump Frequency Width			0.0 to 20.0
Frequency Reference Hold and Up/Down 2 Function	d4-01	Freq. Ref. Hold Function Selection	0, 1	0	×
	d4-03	Freq. Ref. Bias Step (Up/Down 2)	0.00 to 99.99	0.00 Hz	○
	d4-04	Freq. Ref. Bias Accel/Decel (Up/Down 2)	0, 1	0	○
	d4-05	Freq. Ref. Bias Operation Mode Selection (Up/Down 2)	0, 1	0	○
	d4-06	Freq. Ref. Bias (Up/Down 2)	-99.9 to 100.0	0.0%	×
	d4-07	Analog Frequency Reference Fluctuation (Up 2/Down 2)	0.1 to 100.0	1.0%	○
	d4-08	Freq. Ref. Bias Upper Limit (Up/Down 2)	0.0 to 100.0	0.0%	○
	d4-09	Freq. Ref. Bias Lower Limit (Up/Down 2)	-99.9 to 0.0	0.0%	○
	d4-10	Up/Down Freq. Ref. Limit Selection	0, 1	0	×
	Torque Control	d5-01	Torque Control Selection	0, 1	0
d5-02		Torque Reference Delay Time	0 to 1000	0 ms	×
d5-03		Speed Limit Selection	1, 2	1	×
d5-04		Speed Limit	-120 to 120	0%	×
d5-05		Speed Limit Bias	0 to 120	10%	×
d5-06		Speed/Torque Control Switchover Time	0 to 1000	0 ms	×
d5-08		Unidirectional Speed Limit Bias	0, 1	1	×
Field Weakening and Field Forcing		d6-01	Field Weakening Level	0 to 100	80%
	d6-02	Field Weakening Frequency Limit	0.0 to 400.0	0.0 Hz	×
	d6-03	Field Forcing Selection	0, 1	0	×
	d6-06	Field Forcing Limit	100 to 400	400%	×
Offset Frequency	d7-01	Offset Frequency 1	-100.0 to 100.0	0.0%	○
	d7-02	Offset Frequency 2			○
	d7-03	Offset Frequency 3			○
V/f Pattern for motor 1	E1-01	Input Voltage Setting	155 to 255	200 V *5	×
	E1-03	V/f Pattern Selection	0 to F*3	F*1	×
	E1-04	Maximum Output Frequency	40.0 to 400.0*3	*2 dep. on E5-01 for PM motor	×
	E1-05	Maximum Voltage	0.0 to 255.0*5	*2 dep. on E5-01 for PM motor	×
	E1-06	Base Frequency	0.0 to E1-04*3	*2 dep. on E5-01 for PM motor	×
	E1-07	Middle Output Frequency	0.0 to E1-04	*2	×
	E1-08	Middle Output Frequency Voltage	0.0 to 255.0*5	*2	×
	E1-09	Minimum Output Frequency	0.0 to E1-04*5	*2 dep. on E5-01 for PM motor	×
	E1-10	Minimum Output Frequency Voltage	0.0 to 255.0*5	*2	×
	E1-11	Middle Output Frequency 2	0.0 to E1-04*2	0.0 Hz	×
	E1-12	Middle Output Frequency Voltage 2	0.0 to 255.0*2*5	0.0 V	×
	E1-13	Base Voltage	0.0 to 255.0*5	0.0 V*2	×



# Parameter List (continued)

Function	No.	Name	Range	Default	Changes during Run	
Motor 1 Parameters	E2-01	Motor Rated Current	10% to 200% of the drive rated current*2	*2	×	
	E2-02	Motor Rated Slip	0.00 to 20.00	*2	×	
	E2-03	Motor No-Load Current	0 to E2-01*2	*2	×	
	E2-04	Number of Motor Poles	2 to 48	4	×	
	E2-05	Motor Line-to-Line Resistance	0.000 to 65.000	*2	×	
	E2-06	Motor Leakage Inductance	0.0 to 40.0	*2	×	
	E2-07	Motor Iron-Core Saturation Coefficient 1	E2-07 to 0.50	0.50	×	
	E2-08	Motor Iron-Core Saturation Coefficient 2	E2-07 to 0.75	0.75	×	
	E2-09	Motor Mechanical Loss	0.0 to 10.0	0.0%	×	
	E2-10	Motor Iron Loss for Torque Compensation	0 to 65535	*2	×	
	E2-11	Motor Rated Power	0.00 to 650.00	*2	×	
V/f Pattern for Motor 2	E3-01	Motor 2 Control Mode Selection	0 to 3	0	×	
	E3-04	Motor 2 Max. Output Frequency	40.0 to 400.0	dep. on E3-01	×	
	E3-05	Motor 2 Max. Voltage	0.0 to 255.0*5	*5	×	
	E3-06	Motor 2 Base Frequency	0.0 to E3-04	dep. on E3-01	×	
	E3-07	Motor 2 Mid Output Freq.	0.0 to E3-04	dep. on E3-01	×	
	E3-08	Motor 2 Mid Output Freq. Voltage	0.0 to 255.0*5	*5 dep. on E3-01	×	
	E3-09	Motor 2 Min. Output Freq.	0.0 to E3-04	dep. on E3-01	×	
	E3-10	Motor 2 Min. Output Freq. Voltage	0.0 to 255.0*5	*5 dep. on E3-01	×	
	E3-11	Motor 2 Mid Output Frequency 2	0.0 to E3-04*3	0.0*2	×	
	E3-12	Motor 2 Mid Output Frequency Voltage 2	0.0 to 255.0*5	0.0*2	×	
	E3-13	Motor 2 Base Voltage	0.0 to 255.0*5	0.0*2	×	
	Motor 2 Parameters	E4-01	Motor 2 Rated Current	10% to 200% of the drive rated current*2	*2	×
		E4-02	Motor 2 Rated Slip	0.00 to 20.00*2	*2	×
E4-03		Motor 2 Rated No-Load Current	0 to E4-01*2	*2	×	
E4-04		Motor 2 Motor Poles	2 to 48	4	×	
E4-05		Motor 2 Line-to-Line Resistance	0.000 to 65.000	*2	×	
E4-06		Motor 2 Leakage Inductance	0.0 to 40.0	*2	×	
E4-07		Motor 2 Motor Iron-Core Saturation Coefficient 1	0.00 to 0.50	0.50	×	
E4-08		Motor 2 Motor Iron-Core Saturation Coefficient 2	E4-07 to 0.75	0.75	×	
E4-09		Motor 2 Mechanical Loss	0.0 to 10.0	0.0%	×	
E4-10		Motor 2 Iron Loss	0 to 65535	*2	×	
E4-11		Motor 2 Rated Capacity	0.00 to 650.00	*2	×	
PM Motor Settings *8	E5-01	Motor Code Selection	0000 to FFFF	*2 *1	×	
	E5-02	Motor Rated Capacity	0.10 to 650.00	*1 dep. on E5-01	×	
	E5-03	Motor Rated Current	10% to 200% of the drive rated current*2	*1 dep. on E5-01	×	
	E5-04	Number of Motor Poles	2 to 48	*1 dep. on E5-01	×	

Note: Footnotes are listed on page 23.

Function	No.	Name	Range	Default	Changes during Run	
PM Motor Settings *8	E5-05	Motor Stator Resistance	0.000 to 65.000	*1 dep. on E5-01	×	
	E5-06	Motor d-Axis Inductance	0.00 to 300.00	*1 dep. on E5-01	×	
	E5-07	Motor q-Axis Inductance	0.00 to 600.00	*1 dep. on E5-01	×	
	E5-09	Motor Induction Voltage Constant 1	0.0 to 2000.0	*1 dep. on E5-01	×	
	E5-11	Encoder Z Pulse Offset	-180.0 to 180.0	0.0 deg	×	
	E5-24	Motor Induction Voltage Constant 2	0.0 to 2000.0	*1 dep. on E5-01	×	
	PG Speed Control Card (PG-B3/PG-X3)	F1-01	PG 1 Pulses Per Revolution	0 to 60000	600 ppr*3	×
		F1-02	Operation Selection at PG Open Circuit (PGo)	0 to 5	1	×
F1-03		Operation Selection at Overspeed (oS)	0 to 3	1	×	
F1-04		Operation Selection at Deviation	0 to 3	3	×	
F1-05		PG 1 Rotation Selection	0, 1	*3	×	
F1-06		PG 1 Division Rate for PG Pulse Monitor	1 to 132	1	×	
F1-08		Overspeed Detection Level	0 to 120	115%	×	
F1-09		Overspeed Detection Delay Time	0.0 to 2.0	*3	×	
F1-10		Excessive Speed Deviation Detection Level	0 to 50	10%	×	
F1-11		Excessive Speed Deviation Detection Delay Time	0.0 to 10.0	0.5 s	×	
F1-12		PG 1 Gear Teeth 1	0 to 1000	0	×	
F1-13		PG 1 Gear Teeth 2	0 to 1000	0	×	
F1-14		PG Open-Circuit Detection Time	0.0 to 10.0	2.0 s	×	
F1-18		dv3 Detection Selection	0 to 10	10	×	
F1-19		dv4 Detection Selection	0 to 5000	128	×	
F1-20		PG Option Card Disconnect Detection 1	0, 1	1	×	
F1-21		PG 1 Signal Selection	0, 1	0	×	
F1-30	PG Card Option Port for Motor 2 Selection	0, 1	1	×		
F1-31	PG 2 Pulses Per Revolution	0 to 60000	1024 ppr	×		
F1-32	PG 2 Rotation Selection	0, 1	0	×		
F1-33	PG 2 Gear Teeth 1	0 to 1000	0	×		
F1-34	PG 2 Gear Teeth 2	0 to 1000	0	×		
F1-35	PG 2 Division Rate for PG Pulse Monitor	1 to 132	1	×		
F1-36	PG Option Card Disconnect Detection 2	0, 1	1	×		
F1-37	PG 2 Signal Selection	0, 1	0	×		
Analog Input Card (AI-A3)	F2-01	Analog Input Option Card Operation Selection	0, 1	0	×	
	F2-02	Analog Input Option Card Gain	-999.9 to 999.9	100.0%	○	
	F2-03	Analog Input Option Card Bias	-999.9 to 999.9	0.0%	○	
Digital Input Card (DI-A3)	F3-01	Digital Input Option Card Input Selection	0 to 7	0	×	
	F3-03	Digital Input Option DI-A3 Data Length Selection	0 to 2	2	×	
Analog Monitor Card (AO-A3)	F4-01	Terminal V1 Monitor Selection	000 to 999	102	×	
	F4-02	Terminal V1 Monitor Gain	-999.9 to 999.9	100.0%	○	
	F4-03	Terminal V2 Monitor Selection	000 to 999	103	×	
	F4-04	Terminal V2 Monitor Gain	-999.9 to 999.9	50.0%	○	
	F4-05	Terminal V1 Monitor Bias	-999.9 to 999.9	0.0%	○	
	F4-06	Terminal V2 Monitor Bias	-999.9 to 999.9	0.0%	○	
	F4-07	Terminal V1 Signal Level	0, 1	0	×	
	F4-08	Terminal V2 Signal Level	0, 1	0	×	
Digital Output Card (DO-A3)	F5-01	Terminal P1-PC Output Selection	0 to 192	2	×	
	F5-02	Terminal P2-PC Output Selection	0 to 192	4	×	
	F5-03	Terminal P3-PC Output Selection	0 to 192	6	×	
	F5-04	Terminal P4-PC Output Selection	0 to 192	37	×	
	F5-05	Terminal P5-PC Output Selection	0 to 192	F	×	
	F5-06	Terminal P6-PC Output Selection	0 to 192	F	×	
	F5-07	Terminal M1-M2 Output Selection	0 to 192	0	×	
	F5-08	Terminal M3-M4 Output Selection	0 to 192	1	×	
	F5-09	DO-A3 Output Mode Selection	0 to 2	0	×	

Function	No.	Name	Range	Default	Changes during Run	
Communication Option Card	F6-01	Communications Error Operation Selection	0 to 3	1	×	
	F6-02	External Fault from Comm. Option Detection Selection	0, 1	0	×	
	F6-03	External Fault from Comm. Option Operation Selection	0 to 3	1	×	
	F6-04	bUS Error Detection Time	0.0 to 5.0	2.0 s	×	
	F6-06	Torque Reference/Torque Limit Selection from Communications Option	0, 1	0	×	
	F6-07	Multi-Step Speed during NetRet/ComRef	0,1	0	×	
	F6-08	Reset Communication Parameters	0,1	0*1	×	
	F6-10	CC-Link Node Address	0 to 64	0	×	
	F6-11	Communication Speed	0 to 4	0	×	
	F6-14	CC-Link bUS Error Auto Reset	0, 1	0	×	
	F6-20	MECHATROLINK-II Node Address	20 to 3FH	21	×	
	F6-21	MECHATROLINK-II Frame Length	0,1	0	×	
	F6-22	MECHATROLINK-II Link Speed	0,1	0	×	
	F6-23	MECHATROLINK-II Monitor Selection (E)	0 to FFFFH	0	×	
	F6-24	MECHATROLINK-II Monitor Selection (F)	0 to FFFFH	0	×	
	F6-25	MECHATROLINK-II WDT Error Selection	0 to 3	1	×	
	F6-26	MECHATROLINK-II bUS Errors	2 to 10	2	×	
	F6-30	PROFIBUS-DP Node Address	0 to 125	0	×	
	F6-31	PROFIBUS-DP Clear Mode Selection	0, 1	0	×	
	F6-32	PROFIBUS-DP Data Format Selection	0, 1	0	×	
	F6-35	CANopen Node ID Selection	0 to 126	0	×	
	F6-36	CANopen Communication Speed	0 to 8	6	×	
	F6-50 to F6-63	DeviceNet Parameters	—	—	×	
	F6-64 to F6-71	Reserved	—	—	×	
	Multi-Function Digital Inputs	H1-01	Multi-Function Digital Input Terminal S1 Function Selection	1 to 9F	40 (F)*6	×
		H1-02	Multi-Function Digital Input Terminal S2 Function Selection	1 to 9F	41 (F)*6	×
		H1-03	Multi-Function Digital Input Terminal S3 Function Selection	1 to 9F	24	×
		H1-04	Multi-Function Digital Input Terminal S4 Function Selection	1 to 9F	14	×
		H1-05	Multi-Function Digital Input Terminal S5 Function Selection	1 to 9F	3 (0)*6	×
		H1-06	Multi-Function Digital Input Terminal S6 Function Selection	1 to 9F	4 (3)*6	×
		H1-07	Multi-Function Digital Input Terminal S7 Function Selection	1 to 9F	6 (4)*6	×
		H1-08	Multi-Function Digital Input Terminal S8 Function Selection	1 to 9F	8	×
	Multi-Function Digital Outputs	H2-01	Terminals M1-M2 Function Selection (relays)	0 to 192	0	×
H2-02		Terminal P1-PC Function Selection (photocoupler)	0 to 192	1	×	
H2-03		Terminal P2-PC Function Selection (photocoupler)	0 to 192	2	×	
H2-06		Watt Hour Output Unit Selection	0 to 4	0	×	
Multi-Function Analog Inputs	H3-01	Terminal A1 Signal Level Selection	0, 1	0	×	
	H3-02	Terminal A1 Function Selection	0 to 31	0	×	
	H3-03	Terminal A1 Gain Setting	-999.9 to 999.9	100.0%	○	
	H3-04	Terminal A1 Bias Setting	-999.9 to 999.9	0.0%	○	
	H3-05	Terminal A3 Signal Level Selection	0, 1	0	×	
	H3-06	Terminal A3 Function Selection	0 to 31	2	×	
	H3-07	Terminal A3 Gain Setting	-999.9 to 999.9	100.0%	○	
	H3-08	Terminal A3 Bias Setting	-999.9 to 999.9	0.0%	○	

Note: Footnotes are listed on page 23.

Function	No.	Name	Range	Default	Changes during Run
Multi-Function Analog Inputs	H3-09	Terminal A2 Signal Level Selection	0 to 3	2	×
	H3-10	Terminal A2 Function Selection	0 to 31	0	×
	H3-11	Terminal A2 Gain Setting	-999.9 to 999.9	100.0%	○
	H3-12	Terminal A2 Bias Setting	-999.9 to 999.9	0.0%	○
	H3-13	Analog Input Filter Time Constant	0.00 to 2.00	0.03 s	×
	H3-14	Analog Input Terminal Enable Selection	1 to 7	7	×
	H3-16	Multi-Function Analog Input Terminal A1 Offset	-500 ~ 500	0	×
	H3-17	Multi-Function Analog Input Terminal A2 Offset	-500 ~ 500	0	×
H3-18	Multi-Function Analog Input Terminal A3 Offset	-500 ~ 500	0	×	
Multifunction Analog Outputs	H4-01	Multi-Function Analog Output Terminal FM Monitor Selection	000 to 999	102	×
	H4-02	Multi-Function Analog Output Terminal FM Gain	-999.9 to 999.9	100.0%	○
	H4-03	Multi-Function Analog Output Terminal FM Bias	-999.9 to 999.9	0.0%	○
	H4-04	Multi-Function Analog Output Terminal AM Monitor Selection	000 to 999	103	×
	H4-05	Multi-Function Analog Output Terminal AM Gain	-999.9 to 999.9	50.0%	○
	H4-06	Multi-Function Analog Output Terminal AM Bias	-999.9 to 999.9	0.0%	○
	H4-07	Multi-Function Analog Output Terminal FM Signal Level Selection	0, 1	0	×
	H4-08	Multi-Function Analog Output Terminal AM Signal Level Selection	0, 1	0	×
MEMOBUS/Modbus Serial Communication	H5-01	Drive Node Address	0 to FFH	1F	×
	H5-02	Communication Speed Selection	0 to 8	3	×
	H5-03	Communication Parity Selection	0 to 2	0	×
	H5-04	Stopping Method After Communication Error (CE)	0 to 3	0	×
	H5-05	Communication Fault Detection Selection	0, 1	0	×
	H5-06	Drive Transmit Wait Time	5 to 65	5 ms	×
	H5-07	RTS Control Selection	0, 1	1	×
	H5-09	CE Detection Time	0.0 to 10.0	2.0 s	×
	H5-10	Unit Selection for MEMOBUS/Modbus Register 0025H	0, 1	0	×
	H5-11	Communications ENTER Function Selection	0, 1	1	×
	H5-12	Run Command Method Selection	0, 1	0	×
	Pulse Train Input/Output	H6-01	Pulse Train Input Terminal RP Function Selection	0 to 3	0
H6-02		Pulse Train Input Scaling	1000 to 32000	1440 Hz	○
H6-03		Pulse Train Input Gain	0.0 to 1000.0	100.0%	○
H6-04		Pulse Train Input Bias	-100.0 to 100.0	0.0%	○
H6-05		Pulse Train Input Filter Time	0.00 to 2.00	0.10 s	○
H6-06		Pulse Train Monitor Selection	000 to 809	102	○
H6-07		Pulse Train Monitor Scaling	0 to 32000	1440 Hz	○
H6-08		Pulse Train Input Minimum Frequency	0.1 to 1000.0	0.5 Hz	×
Motor Protection	L1-01	Motor Overload Protection Selection	0 to 5	*3	×
	L1-02	Motor Overload Protection Time	0.1 to 5.0	1.0 min.	×
	L1-03	Motor Overheat Alarm Operation Selection (PTC input)	0 to 3	3	×
	L1-04	Motor Overheat Fault Operation Selection (PTC input)	0 to 2	1	×
	L1-05	Motor Temperature Input Filter Time (PTC input)	0.00 to 10.00	0.20 s	×
L1-13	Continuous Electrothermal Operation Selection	0, 1	1	×	



# Parameter List (continued)

Function	No.	Name	Range	Default	Online Changing
Momentary Power Loss Ride-Thru	L2-01	Momentary Power Loss Operation Selection	0 to 5	0	×
	L2-02	Momentary Power Loss Ride-Thru Time	0.0 to 25.5	*2	×
	L2-03	Momentary Power Loss Minimum Baseblock Time	0.1 to 5.0	*2	×
	L2-04	Momentary Power Loss Voltage Recovery Ramp Time	0.0 to 5.0	*2	×
	L2-05	Undervoltage Detection Level (Uv)	150 to 210*5	*5 dep. on E1-01	×
	L2-06	KEB Deceleration Time	0.00 to 6000.00*2	0.00 s	×
	L2-07	KEB Acceleration Time	0.00 to 6000.00*2	0.00 s	×
	L2-08	Frequency Gain at KEB Start	0 to 300	100%	×
	L2-10	KEB Detection Time	0 to 2000	50 ms	×
	L2-11	DC Bus Voltage Setpoint during KEB	150 to 400*5	*5 dep. on E1-01	×
L2-29	KEB Method Selection	0 to 3	0	×	
Stall Prevention	L3-01	Stall Prevention Selection during Acceleration	0 to 2	1	×
	L3-02	Stall Prevention Level during Acceleration	0 to 150*2	*2	×
	L3-03	Stall Prevention Limit during Acceleration	0 to 100	50%	×
	L3-04	Stall Prevention Selection during Deceleration	0 to 5*3	1	×
	L3-05	Stall Prevention Selection during Run	0 to 2	1	×
	L3-06	Stall Prevention Level during Run	30 to 150*2	*2	×
	L3-11	Overvoltage Suppression Function Selection	0, 1	0	×
	L3-17	Target DC Bus Voltage for Overvoltage Suppression and Stall Prevention	150 to 400*5	370 Vdc*5 dep. on E1-01	×
	L3-20	DC Bus Voltage Adjustment Gain	0.00 to 5.00	*3	×
	L3-21	Accel/Decel Rate Calculation Gain	0.10 to 200.00	1.00	×
L3-22	Deceleration Time at Stall Prevention during Acceleration	0.0 to 6000.0	0.0 s	×	
L3-23	Automatic Reduction Selection for Stall Prevention during Run	0, 1	0	×	
L3-24	Motor Acceleration Time for Inertia Calculations	0.001 to 10.000	*2 dep. on E2-11 dep. on E5-01	×	
L3-25	Load Inertia Ratio	0.0 to 1000.0	1.0	×	
L3-26	Additional DC Bus Capacitors	0 to 65000	0 $\mu$ F	×	
L3-27	Stall Prevention Detection Time	0 to 5000	50 ms	×	
Speed Detection	L4-01	Speed Agreement Detection Level	0.0 to 400.0	0.0 Hz	×
	L4-02	Speed Agreement Detection Width	0.0 to 20.0	*3	×
	L4-03	Speed Agreement Detection Level (+/-)	-400.0 to 400.0	0.0 Hz	×
	L4-04	Speed Agreement Detection Width (+/-)	0.0 to 20.0	*3	×
	L4-05	Frequency Reference Loss Detection Selection	0, 1	0	×
	L4-06	Frequency Reference at Reference Loss	0.0 to 100.0	80.0%	×
	L4-07	Speed Agreement Detection Selection	0, 1	0	×
Fault Reset	L5-01	Number of Auto Restart Attempts	0 to 10	0	×
	L5-02	Auto Restart Fault Output Operation Selection	0, 1	0	×
	L5-04	Fault Reset Interval Time	0.5 to 600.0	10.0 s	×
L5-05	Fault Reset Operation Selection	0, 1	0	×	

Note: Footnotes are listed on page 23.

Function	No.	Name	Range	Default	Online Changing	
Torque Detection	L6-01	Torque Detection Selection 1	0 to 8	0	×	
	L6-02	Torque Detection Level 1	0 to 300	150%	×	
	L6-03	Torque Detection Time 1	0.0 to 10.0	0.1 s	×	
	L6-04	Torque Detection Selection 2	0 to 8	0	×	
	L6-05	Torque Detection Level 2	0 to 300	150%	×	
	L6-06	Torque Detection Time 2	0.0 to 10.0	0.1 s	×	
	L6-08	Mechanical Weakening Detection Operation	0 to 8	0	×	
	L6-09	Mechanical Weakening Detection Speed Level	-110.0 to 110.0	110.0%	×	
	L6-10	Mechanical Weakening Detection Time	0.0 to 10.0	0.1 s	×	
	L6-11	Mechanical Weakening Detection Start Time	0 to 65535	0	×	
	Torque Limit	L7-01	Forward Torque Limit	0 to 300	200%	×
L7-02		Reverse Torque Limit	0 to 300	200%	×	
L7-03		Forward Regenerative Torque Limit	0 to 300	200%	×	
L7-04		Reverse Regenerative Torque Limit	0 to 300	200%	×	
L7-06		Torque Limit Integral Time Constant	5 to 10000	200 ms	×	
L7-07		Torque Limit Control Method Selection during Accel/Decel	0, 1	0	×	
L7-16		Torque Limit Delay at Start	0, 1	1	×	
Drive Protection	L8-01	Internal Dynamic Braking Resistor Protection Selection (ERF type)	0, 1	0	×	
	L8-02	Overheat Alarm Level	50 to 150	*2	×	
	L8-03	Overheat Pre-Alarm Operation Selection	0 to 4	3	×	
	L8-05	Input Phase Loss Protection Selection	0, 1	0	×	
	L8-07	Output Phase Loss Protection	0 to 2	0	×	
	L8-09	Output Ground Fault Detection Selection	0, 1	*2	×	
	L8-10	Heatsink Cooling Fan Operation Selection	0, 1	0	×	
	L8-11	Heatsink Cooling Fan Off Delay Time	0 to 300	60 s	×	
	L8-12	Ambient Temperature Setting	-10 to 50	40°C	×	
	L8-15	oL2 Characteristics Selection at Low Speeds	0, 1	1	×	
	L8-18	Software Current Limit Selection	0, 1	0	×	
	L8-19	Frequency Reduction Rate during oH Pre-Alarm	0.1 to 0.9	0.8	×	
	L8-27	Overcurrent Detection Gain	0.0 to 300.0	300.0%	×	
	L8-29	Current Unbalance Detection (LF2)	0, 1	1	×	
	L8-32	Magnetic Contactor, Fan Power Supply Fault Selection	0 to 4	1	×	
	L8-35	Installation Method Selection	0 to 3	*1 *2	×	
	L8-38	Carrier Frequency Reduction Selection	0 to 2	*2	×	
	L8-40	Carrier Frequency Reduction Off Delay Time	0.00 to 2.00	*3	×	
	L8-41	High Current Alarm Selection	0, 1	0	×	
	L8-55	Internal Braking Transistor Protection	0, 1	1	×	
L8-78*10	Power Unit Output Phase Loss Protection	0, 1	1	×		
Hunting Prevention	n1-01	Hunting Prevention Selection	0, 1	1	×	
	n1-02	Hunting Prevention Gain Setting	0.00 to 2.50	1.00	×	
	n1-03	Hunting Prevention Time Constant	0 to 500	*4	×	
	n1-05	Hunting Prevention Gain while in Reverse	0.00 to 2.50	0.00	×	
	Speed Feedback Detection Control (ASR) Tuning	n2-01	Speed Feedback Detection Control (AFR) Gain	0.00 to 10.00	1.00	×
n2-02		Speed Feedback Detection Control (AFR) Time Constant 1	0 to 2000	50 ms	×	
n2-03		Speed Feedback Detection Control (AFR) Time Constant 2	0 to 2000	750 ms	×	
High Slip Braking and Overexcitation Braking	n3-01	High-Slip Braking Deceleration Frequency Width	1 to 20	5%	×	
	n3-02	High-Slip Braking Current Limit	100 to 200	*2	×	
	n3-03	High-Slip Braking Dwell Time at Stop	0.0 to 10.0	1.0 s	×	
	n3-04	High-Slip Braking Overload Time	30 to 1200	40 s	×	
	n3-13	Overexcitation Deceleration Gain	1.00 to 1.40	1.10	×	
	n3-14	High Frequency Injection during Overexcitation Deceleration	0, 1	0	×	
	n3-21	High-Slip Suppression Current Level	0 to 150	100%	×	
	n3-23	Overexcitation Operation Selection	0 to 2	0	×	
	Feed Forward Control	n5-01	Feed Forward Control Selection	0, 1	0	×
		n5-02	Motor Acceleration Time	0.001 to 10.000	*2 dep. on E5-01	×
n5-03		Feed Forward Control Gain	0.00 to 100.00	1.00	×	



Function	No.	Name	Range	Default	Online Changing
Online Tuning *8	n6-01	Online Tuning Selection	0 to 2	2	×
	n6-05	Online Tuning Gain	0.10 to 5.00	1.00	×
PM Motor Control Tuning *8	n8-01	Initial Rotor Position Estimation Current	0 to 100	50%	×
	n8-02	Pole Attraction Current	0 to 150	80%	×
	n8-35	Initial Rotor Position Detection Selection	0 to 2	1	×
	n8-45	Speed Feedback Detection Control Gain	0.00 to 10.00	0.80	×
	n8-47	Pull-In Current Compensation Time Constant	0.0 to 100.0	5.0 s	×
	n8-48	Pull-In Current	20 to 200	30%	×
	n8-49	d-Axis Current for High Efficiency Control	-200.0 to 0.0	dep. on E5-01	×
	n8-51	Acceleration/Deceleration Pull-In Current	0 to 200	50%	×
	n8-54	Voltage Error Compensation Time Constant	0.00 to 10.00	1.00 s	×
	n8-55	Load Inertia	0 to 3	0	×
	n8-57	High Frequency Injection	0, 1	0	×
	n8-62	Output Voltage Limit	0.0 to 230.0*5	200.0 Vac*5	×
	n8-65	Speed Feedback Detection Control Gain during ov Suppression	0.00 to 10.00	1.50	×
Digital Operator Display Selection	o1-01	Drive Mode Unit Monitor Selection	104 to 809	106	○
	o1-02	User Monitor Selection After Power Up	1 to 5	1	○
	o1-03	Digital Operator Display Selection	0 to 3	*3	×
	o1-04	V/f Pattern Display Unit	0, 1	*3	×
	o1-10	User-Set Display Units Maximum Value	1 to 60000	*2	×
	o1-11	User-Set Display Units Decimal Display	0 to 3	*2	×
Digital Operator Keypad Functions	o2-01	LO/RE Key Function Selection	0, 1	1	×
	o2-02	STOP Key Function Selection	0, 1	1	×
	o2-03	User Parameter Default Value	0 to 2	0	×
	o2-04	Drive Model Selection	—	dep. on drive capacity	×
	o2-05	Frequency Reference Setting Method Selection	0, 1	0	×
	o2-06	Operation Selection when Digital Operator is Disconnected	0, 1	0	×
	o2-07	Motor Direction at Power Up when Using Operator	0, 1	0	×
	o2-09	Reserved	—	—	×
	o2-09	Reserved	—	—	×
Copy Function	o3-01	Copy Function Selection	0 to 3	0	×
	o3-02	Copy Allowed Selection	0, 1	0	×
Maintenance Monitor Settings	o4-01	Cumulative Operation Time Setting	0 to 9999	0 H	×
	o4-02	Cumulative Operation Time Selection	0, 1	0	×
	o4-03	Cooling Fan Operation Time Setting	0 to 9999	0 H	×
	o4-05	Capacitor Maintenance Setting	0 to 150	0%	×
	o4-07	DC Bus Pre-charge Relay Maintenance Setting	0 to 150	0%	×
	o4-09	IGBT Maintenance Setting	0 to 150	0%	×
	o4-11	U2, U3 Initialize Selection	0, 1	0	×
	o4-12	kWh Monitor Initialization	0, 1	0	×
	o4-13	Number of Run Commands Counter Initialization	0, 1	0	×
DWEZ Parameters	q1-01 to q6-07	DWEZ Parameters	—	—	×

- \*1: Parameter is not reset to the default value when the drive is initialized (A1-03).
- \*2: Value depends on other related parameter settings. Refer to A1000 Technical Manual for details.
- \*3: Default setting depends on the control mode (A1-02). Refer to A1000 Technical Manual for details.
- \*4: Default setting depends on drive capacity (o2-04). Refer to A1000 Technical Manual for details.
- \*5: Value shown here is for 200 V class drives. Double the value when using a 400 V class drive.
- \*6: Value in parenthesis is the default setting for a 3-wire sequence.
- \*7: Sets the value for a SST4 series 1750 r/min motor according to the capacity entered to T2-02.

**These notes concern drive models 450 kW and above.**

- \*8: The following parameters groups are not displayed:
  - b8 (Energy Saving)
  - E5 (PM Motor Settings)
  - n3 (High Slip Braking and Overexcitation Braking)

Function	No.	Name	Range	Default	Online Changing
DWEZ Connection Parameters	r1-01 to r1-40	DWEZ Connection Parameter 1 to 20 (upper/lower)	0 to FFFFH	0	×
	T1-00	Motor 1 / Motor 2 Selection	1, 2	1	×
	T1-01	Auto-Tuning Mode Selection	0 to 4,8,9*3	0	×
	T1-02	Motor Rated Power	0.00 to 650.00	*4	×
	T1-03	Motor Rated Voltage	0.0 to 255.0*5	200.0 Vac*5	×
	T1-04	Motor Rated Current	10% to 200% of the drive rated current	*4	×
	T1-05	Motor Base Frequency	0.0 to 400.0	60.0 Hz	×
	T1-06	Number of Motor Poles	2 to 48	4	×
	T1-07	Motor Base Speed	0 to 24000	1750 r/min	×
	T1-08	PG Number of Pulses Per Revolution	0 to 60000	600 ppr	×
Induction Motor Auto-Tuning	T1-09	Motor No-Load Current (Stationary Auto-Tuning)	0 to T1-04	—	—
	T1-10	Motor Rated Slip (Stationary Auto-Tuning)	0.00 to 20.00	—	—
	T1-11	Motor Iron Loss	0 to 65535	14 W*2	×
	T2-01	PM Motor Auto-Tuning Mode Selection	0 to 3,8,9*3	0	×
	T2-02	PM Motor Code Selection	0000 to FFFF	*2	×
	T2-03	PM Motor Type	0,1	1	×
	T2-04	PM Motor Rated Power	0.00 to 650.00	*4	×
	T2-05	PM Motor Rated Voltage	0.0 to 255.0*5	200.0 Vac*5	×
	T2-06	PM Motor Rated Current	10% to 200% of the drive rated current	*4	×
	T2-07	PM Motor Base Frequency	0.0 to 400.0	87.5 Hz	×
	T2-08	Number of PM Motor Poles	2 to 48	6	×
	T2-09	PM Motor Base Speed	0 to 24000	1750 r/min	×
	T2-10	PM Motor Stator Resistance	0.000 to 65.000	*7	×
	T2-11	PM Motor d-Axis Inductance	0.00 to 600.00	*7	×
	T2-12	PM Motor q-Axis Inductance	0.00 to 600.00	*7	×
	T2-13	Induced Voltage Constant Unit Selection	0,1	1	×
	PM Motor Auto-Tuning *8	T2-14	PM Motor Induced Voltage Constant	0.1 to 2000.0	*7
T2-15		Pull-In Current Level for PM Motor Tuning	0 to 120	30%	—
T2-16		PG Number of Pulses Per Revolution for PM Motor Tuning	0 to 15000	1024 ppr	—
T2-17		Encoder Z Pulse Offset	-180.0 to 180.0	0.0 deg	×
ASR and Inertia Tuning *8	T3-01	Test Signal Frequency	0.1 to 20.0	3.0 Hz	×
	T3-02	Test Signal Amplitude	0.1 to 10.0	0.5 rad	×
	T3-03	Motor Inertia	0.0001 to 600.00	*2 dep. on E5-01	×
	T3-04	System Response Frequency	0.1 to 50.0	10.0 Hz	×

- n5 (Feed Forward Control)
- n6 (Online Tuning)
- n8 (PM Motor Control Tuning)
- T2 (PM Motor Auto-Tuning)
- T3 (ASR and Inertia Tuning)
- \*9: The following settings ranges are for drive models up to 355 kW:
  - A1-02 (Control Method Selection) setting range is 0 to 3, and 5 to 7 when using a control mode designed for a PM motor.
  - C6-02 (Carrier Frequency Selection) setting range is 1, 2, or 7. Selections 3 through 4 are not displayed. The upper limit for the carrier frequency is 5 kHz. Swing PWM is not available.
  - L2-01 (Momentary Power Loss Operation Selection) setting range is 0 to 4. Setting 5 is not available.
  - L3-04 (Stall Prevention Selection during Deceleration) setting range is 0, 1, 4, and 5. Settings 2 and 3 are not available.
- \*10: Parameter L8-78 is available only for drives 450 kW and above.

# Basic Instructions

## Outstanding operability and quick setup

### Operator Names and Functions

**Up arrow key**  
Scrolls up through the display screen, and increases a selected value.

**ESC key**  
Lets the user back up to the previous display screen.

**Right arrow key**  
Scrolls the cursor to the right.

**RESET key**  
Resets a fault.

**Glossary**  
Used as a quick guide for the abbreviations used on the display screen. Details listed on the next page.

**Down arrow key**  
Scrolls down through the display screen, and decreases a selected value.

**RUN key**  
Issues a Run command.

**LED panel**  
More information listed below.

**Data display (5-digit)**  
Displays frequency, parameter number, and other data.

**LO/RE light**  
Lights to indicate that the operator is set for LOCAL.

**LO/RE key**  
Determines where the Run command and frequency reference come from: the keypad (LOCAL) or the control terminals (REMOTE).

**ENTER key**  
Press to enter values, edit parameters, and set the control mode. Press this key to proceed to the next screen when scrolling through various menu displays.

**STOP key**  
Issues a Stop command.

**Com port**  
For connecting to a PC (DriveWizard or DriveWorksEZ), a USB copy unit or a LCD operator.

**Lights during communications**

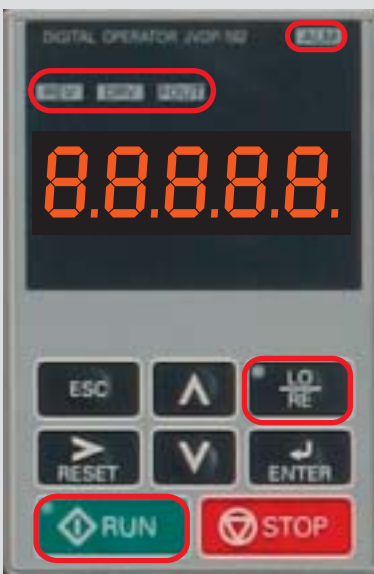

### LED Display Guide

LED	ON	Flashing	OFF
ALM	A fault has occurred.	<ul style="list-style-type: none"> <li>Alarm situation detected.</li> <li>Operator error (OPE)</li> </ul>	Normal operation
REV	Motor is rotating in reverse.	—	Motor is rotating forward.
DRV	In the "Drive Mode"	—	Programming Mode
FOUT	Output frequency	—	—
LO/RE	Run command assigned to the operator (LOCAL)	—	Control assigned to remote location
RUN	During run	<ul style="list-style-type: none"> <li>During deceleration</li> <li>Run command is present but the frequency reference is zero.</li> </ul>	Drive is stopped.

### How the RUN light works:

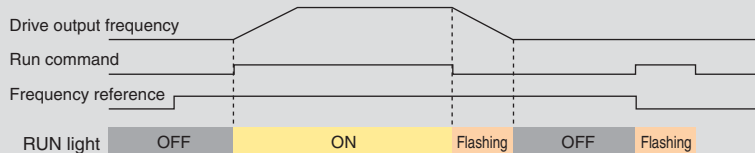



## Operation Example

### Using the LED Operator to Run the Drive

Steps	Key	Result/Display
1 Turn the power on.		F 0.00
2 Set the drive for LOCAL. The frequency reference is displayed.	LO RE	LO Should light F 0.00
3 Displays the direction (forward/reverse).	↑	For
4 Displays the output frequency.	↑	0.00
5 Displays the output current.	↑	0.00A
6 Displays the output voltage.	↑	0.00V
7 Displays the beginning of the Monitor Menu.	↑	flashing r7on
8 Displays the top of the Verify Menu.	↑	flashing urF4
9 Displays the top of the Setup Mode.	↑	flashing SfUP
10 Displays the top of the parameter settings menu.	↑	Pr
11 Displays the top of the Auto-Tuning Mode.	↑	ArUn
Returns back to the frequency reference display.	↑	

Value will flash when it is possible to change the setting.

**Drive Mode:** Run and Stop commands, displays operation status such as the frequency reference, output frequency, output current, output voltage, etc.

How to Monitor the Frequency Reference

Steps	Key	Result/Display
Use the arrow keys to select the digits to set.	ENTER	F00.00
	RESET	F00.00
Press enter to save the new value.	↑	F06.00
	↓	F06.00
	ENTER	F06.00 "End" appears while the drive saves the new data.
		DRV DRV lights up.

**Monitor Mode:** Displays operation status and information on faults.

Steps	Key	Result/Display
Selecting a Monitor for Display. Displays U1-01, the frequency reference monitor.	ENTER	U1-01
	ENTER	6.00
Re-select the monitor display menu.	ESC	U1-01
	↑	U1-02
Back up to the top of the Monitor Menu.	↑	U1-26
	ESC Press once.	r7on

**Verify Menu:** Lists all parameters that have been changed from their original default settings, either by the user or from Auto-Tuning.

Steps	Key	Result/Display
Lists parameters that have been changed in order. Pressing Enter displays the parameter value.	ENTER	C1-01
	ENTER	0003.0
Parameters that have been changed from their default values are listed in order.	ESC	C1-01
	↑	C1-02
Returns to the top of the Verify Menu	↑	C6-02
	ESC Press once.	urF4

Press ESC to go back to the previous display screen

## Setup Mode

The list of Applications Presets can be accessed in the Setup Mode. Each Application Preset automatically programs drive parameters to their optimal settings specific to the application selected. All parameters affected by the Application Preset are then listed as Preferred Parameters for quick access.

Selecting a Conveyor (A1-06=1)

Steps	Key	Result/Display
Application Selection	ENTER	APPL
	ENTER	00
Select, "Conveyor".	RESET	00
	↑	02
All parameters relating to the preset values for a Conveyor application are then listed as Preferred Parameters.	ENTER	"End" appears while the drive saves the new data. APPL
	↑	Scroll to the Preferred Parameter using the up arrow key and see which parameters have been selected.

### Conveyor Application Presets

No.	Parameter Name	Optimum Setting
A1-02	Control Method Selection	0: V/f Control
C1-01	Acceleration Time 1	3.0 (s)
C1-02	Deceleration Time 1	3.0 (s)
C6-01	Duty Mode Selection	0: Heavy Duty (HD)
L3-04	Stall Prevention Selection during Deceleration	1: Enabled

### Preferred Parameters

No.	Parameter Name	No.	Parameter Name
A1-02	Control Method Selection	C1-02	Deceleration Time 1
b1-01	Frequency Reference Selection 1	E2-01	Motor Rated Current
b1-02	Run Command Selection 1	L3-04	Stall Prevention Selection during Deceleration
C1-01	Acceleration Time 1	-	-



# Standard Specifications

Parameter C6-01 sets the drive for Normal Duty or Heavy Duty performance (default).

## 200 V Class

ND : Normal Duty, HD : Heavy Duty

Model CIMR-AA2A		0004	0006	0008*7	0010	0012	0018*7	0021	0030	0040	0056	0069	0081	0110	0138	0169	0211	0250	0312	0360	0415	
Max. Applicable	ND	0.75	1.1	1.5	2.2	3	3.7	5.5	7.5	11	15	18.5	22	30	37	45	55	75	90	110	110	
Motor Capacity*1	kW	0.4	0.75	1.1	1.5	2.2	3	3.7	5.5	7.5	11	15	18.5	22	30	37	45	55	75	90	110	
Input	Rated Input	ND	3.9	7.3	8.8	10.8	13.9	18.5	24	37	52	68	80	92	111	136	164	200	271	324	394	471
	Current*2	A	2.9	5.8	7	7.5	11	15.6	18.9	28	37	52	68	80	82	111	136	164	200	271	324	394
Output	Rated Output	ND*4	1.3	2.3	3	3.7	4.6	6.7	8	11.4	15.2	21	26	31	42	53	64	80	95	119	137	158
	Capacity*3	kVA	1.2*5	1.9*5	2.6*5	3*5	4.2*5	5.3*5	6.7*5	9.5*5	12.6*5	17.9*5	23*5	29*5	32*5	44*5	55*6	69*6	82*6	108*6	132*6	158*4
Output	Rated Output	ND*4	3.5	6	8	9.6	12	17.5	21	30	40	56	69	81	110	138	169	211	250	312	360	415
	Current	A	3.2*5	5*5	6.9*5	8*5	11*5	14*5	17.5*5	25*5	33*5	47*5	60*5	75*5	85*5	115*5	145*6	180*6	215*6	283*6	346*6	415*4
Power	Overload Tolerance	ND Rating*8: 120% of rated output current for 60 s, HD Rating*8: 150% of rated output current for 60 s (Derating may be required for repetitive loads)																				
	Carrier Frequency	1 to 15 kHz*8														1 to 10 kHz*8						
	Max. Output Voltage	Three-phase 200 to 240 V (relative to input voltage)																				
	Max. Output Frequency	400 Hz*8																				
	Rated Voltage/Rated Frequency	Three-phase 200 to 240 Vac 50/60 Hz, 270 to 340 Vdc*9																				
Power	Allowable Voltage Fluctuation	-15% to +10%																				
	Allowable Frequency Fluctuation	±5%																				
	Power Supply	ND	2.2	3.1	4.1	5.8	7.8	9.5	14	18	27	36	44	52	51	62	75	91	124	148	180	215
	kVA	1.3	2.2	3.1	4.1	5.8	7.8	9.5	14	18	27	36	44	37	51	62	75	91	124	148	180	
Harmonic Suppression	DC Reactor	Option												Built-in								
Braking Function	Braking Resistor	Built-in														Option						

- \*1: The motor capacity (kW) refers to a Yaskawa 4-pole, 60 Hz, 200 V motor. The rated output current of the drive output amps should be equal to or greater than the motor rated current.
- \*2: Value displayed is for when operating at the rated output current. This value may fluctuate based on the power supply side impedance, as well as the input current, power supply transformer, input side reactor, and wiring conditions.
- \*3: Rated output capacity is calculated with a rated output voltage of 220 V.
- \*4: This value assumes a carrier frequency of 2 kHz. Increasing the carrier frequency requires a reduction in current.
- \*5: This value assumes a carrier frequency of 8 kHz. Increasing the carrier frequency requires a reduction in current.
- \*6: This value assumes a carrier frequency of 5 kHz. Increasing the carrier frequency requires a reduction in current.
- \*7: These models are available in Japan only.
- \*8: Carrier frequency can be set by the user.
- \*9: DC input power supply is not UL or CE certified.

## 400 V Class

ND : Normal Duty, HD : Heavy Duty

Model CIMR-AA4A		0002	0004	0005	0007	0009	0011	0018	0023	0031	0038	0044	0058	0072	0088	0103	0139	0165	0208	0250	0296	0362	0414	0515	0675	0930	1200		
Max. Applicable	ND	0.75	1.5	2.2	3	3.7	5.5	7.5	11	15	18.5	22	30	37	45	55	75	90	110	132	160	185	220	250	355	500	630		
Motor Capacity*1	kW	0.4	0.75	1.5	2.2	3	3.7	5.5	7.5	11	15	18.5	22	30	37	45	55	75	90	110	132	160	185	220	315	450	560		
Input	Rated Input	ND	2.1	4.3	5.9	8.1	9.4	14	20	24	38	44	52	58	71	86	105	142	170	207	248	300	346	410	465	657	922	1158	
	Current*2	A	1.8	3.2	4.4	6	8.2	10.4	15	20	29	39	44	43	58	71	86	105	142	170	207	248	300	346	410	584	830	1031	
Output	Rated Output	ND*4	1.6	3.1	4.1	5.3	6.7	8.5	13.3	17.5	24	29	34	44	55	67	78	106	126	159	191	226	276	316	392	514	709	915	
	Capacity*3	kVA	1.4*5	2.6*5	3.7*5	4.2*5	5.5*5	7*5	11.3*5	13.7*5	18.3*5	24*5	30*5	34*5	46*5	57*5	69*5	85*5	114*6	137*6	165*6	198*6	232*6	282*6	343*6	461*6	617*6	831*6	
Output	Rated Output	ND*4	2.1	4.1	5.4	6.9	8.8	11.1	17.5	23	31	38	44	58	72	88	103	139	165	208	250	296	362	414	515	675	930	1200	
	Current	A	1.8*5	3.4*5	4.8*5	5.5*5	7.2*5	9.2*5	14.8*5	18*5	24*5	31*5	39*5	45*5	60*5	75*5	91*5	112*5	150*6	180*6	216*6	260*6	304*6	370*6	450*6	605*6	810*6	1090*6	
Power	Overload Tolerance	ND Rating*7: 120% of rated output current for 60 s, HD Rating*7: 150% of rated output current for 60 s (Derating may be required for repetitive loads)																											
	Carrier Frequency	1 to 15 kHz*7														1 to 10 kHz*7							1 to 5 kHz*7			2 kHz			
	Max. Output Voltage	Three-phase 380 to 480 V (relative to input voltage)																											Input voltage x 0.95
	Max. Output Frequency	400 Hz*7																											
	Rated Voltage/Rated Frequency	Three-phase 380 to 480 Vac 50/60 Hz, 510 to 680 Vdc*8																											
Power	Allowable Voltage Fluctuation	-15% to +10%																											
	Allowable Frequency Fluctuation	±5%																											
	Power Supply	ND	2.3	4.3	6.1	8.1	10	14.4	19.4	28.4	37.5	46.6	54.9	53	64.9	78.6	96	130	156	189	227	274	316	375	416	601	843	1059	
	kVA	1.4	2.3	4.3	6.1	8.1	10	14.6	19.2	28.4	37.5	46.6	39.3	53	64.9	78.6	96	130	156	189	227	274	316	375	508	759	943		
Harmonic Suppression	DC Reactor	Option														Built-in													
Braking Function	Braking Resistor	Built-in														Option													

- \*1: The motor capacity (kW) refers to a Yaskawa 4-pole, 60 Hz, 400 V motor. The rated output current of the drive output amps should be equal to or greater than the motor rated current.
- \*2: Value displayed is for when operating at the rated output current. This value may fluctuate based on the power supply side impedance, as well as the input current, power supply transformer, input side reactor, and wiring conditions.
- \*3: Rated output capacity is calculated with a rated output voltage of 440 V.
- \*4: This value assumes a carrier frequency of 2 kHz. Increasing the carrier frequency requires a reduction in current.
- \*5: This value assumes a carrier frequency of 8 kHz. Increasing the carrier frequency requires a reduction in current.
- \*6: This value assumes a carrier frequency of 5 kHz. Increasing the carrier frequency requires a reduction in current.
- \*7: Carrier frequency can be set by the user.
- \*8: DC input power supply is not UL or CE certified.

## Common Specifications

Item	Specifications	
Control Characteristics	Control Method*1	V/f Control, V/f Control with PG, Open Loop Vector Control, Closed Loop Vector Control with PG, Open Loop Vector Control for PM, Advanced Open Loop Vector Control for PM, Closed Loop Vector Control for PM
	Frequency Control Range	0.01 to 400 Hz
	Frequency Accuracy (Temperature Fluctuation)	Digital reference: within $\pm 0.01\%$ of the max. output frequency ( $-10$ to $+40^\circ\text{C}$ ) Analog reference: within $\pm 0.1\%$ of the max. output frequency ( $25^\circ\text{C} \pm 10^\circ\text{C}$ )
	Frequency Setting Resolution	Digital reference: 0.01 Hz Analog reference: 0.03 Hz / 60 Hz (11 bit)
	Output Frequency Resolution	0.001 Hz
	Frequency Setting Resolution	$-10$ to $+10$ V, $0$ to $+10$ V, $4$ to $20$ mA, pulse train
	Starting Torque	150%/3 Hz (V/f Control and V/f Control with PG), 200%/0.3 Hz*2 (Open Loop Vector Control), 200%/0 r/min*2 (Closed Loop Vector Control, Closed Loop Vector Control for PM, and Advanced Open Loop Vector Control for PM), 100%/5% speed (Open Loop Vector Control for PM)
	Speed Control Range	1:1500 (Closed Loop Vector Control and Closed Loop Vector Control for PM) 1:200 (Open Loop Vector Control) 1:40 (V/f Control and V/f Control with PG) 1:20 (Open Loop Vector Control for PM) 1:100 (Advanced Open Loop Vector Control for PM)
	Speed Control Accuracy	$\pm 0.2\%$ in Open Loop Vector Control ( $25^\circ\text{C} \pm 10^\circ\text{C}$ ) *3, $\pm 0.02\%$ in Closed Loop Vector Control ( $25^\circ\text{C} \pm 10^\circ\text{C}$ )
	Speed Response	10 Hz in Open Loop Vector Control ( $25^\circ\text{C} \pm 10^\circ\text{C}$ ), 50 Hz in Closed Loop Vector Control ( $25^\circ\text{C} \pm 10^\circ\text{C}$ ) (excludes temperature fluctuation when performing Rotational Auto-Tuning)
	Torque Limit	All vector control modes allow separate settings in four quadrants
	Accel/Decel Time	0.00 to 6000.0 s (4 selectable combinations of independent acceleration and deceleration settings)
	Braking Torque	Drives of 200/400 V 30 kW or less have a built-in braking transistor. ① Short-time decel torque*4: over 100% for 0.4/ 0.75 kW motors, over 50% for 1.5 kW motors, and over 20% for 2.2 kW and above motors (Overexcitation Deceleration, High Slip Braking: approx. 40%) ② Continuous regen. torque: approx. 20% (approx. 125% with dynamic braking resistor option*5: 10% ED, 10 s
	V/f Characteristics	User-selected programs and V/f preset patterns possible
Main Control Functions	Torque Control, Droop Control, Speed/Torque Control switch, Feed Forward Control, Zero Servo Control, Momentary Power Loss Ride-Thru, Speed Search, Overtorque detection, torque limit, 17 Step Speed (max.), accel/decel time switch, S-curve accel/decel, 3-wire sequence, Auto-Tuning (rotational, stationary), Online Tuning, Dwell, cooling fan on/off switch, slip compensation, torque compensation, Frequency Jump, Upper/lower limits for frequency reference, DC Injection Braking at start and stop, Overexcitation Deceleration, High Slip Braking, PID control (with Sleep function), Energy Saving Control, MEMOBUS comm. (RS-485/422, max. 115.2 kbps), Fault Restart, Application Presets, DriveWorksEZ (customized functions), Removable Terminal Block with Parameter Backup...	
Protection Function	Motor Protection	Motor overheat protection based on output current
	Momentary Overcurrent Protection	Drive stops when output current exceeds 200% of Heavy Duty rating
	Overload Protection	Drive stops after 60 s at 150% of rated output current (Heavy Duty rating)*6
	Overvoltage Protection	200 V class: Stops when DC bus exceeds approx. 410 V, 400 V class: Stops when DC bus exceeds approx. 820 V
	Undervoltage Protection	200 V class: Stops when DC bus exceeds approx. 190 V, 400 V class: Stops when DC bus exceeds approx. 380 V
	Momentary Power Loss Ride-Thru	Stops immediately after 15 ms or longer power loss (default). Continuous operation during power up to 2 s (standard).*7
	Heatsink Overheat Protection	Thermistor
	Braking Resistance Overheat Protection	Overheat sensor for braking resistor (optional ERF-type, 3% ED)
	Stall Prevention	Stall prevention during acceleration/deceleration and constant speed operation
	Ground Fault Protection	Protection by electronic circuit *8
	Charge LED	Charge LED remains lit until DC bus has fallen below approx. 50 V
Environment	Area of Use	Indoors
	Ambient Temperature	$-10$ to $+50^\circ\text{C}$ (open-chassis), $-10$ to $+40^\circ\text{C}$ (NEMA Type 1)
	Humidity	95% RH or less (no condensation)
	Storage Temperature	$-20$ to $+60^\circ\text{C}$ (short-term temperature during transportation)
	Altitude	Up to 1000 meters
	Shock	10 Hz to 20 Hz, 9.8 m/s <sup>2</sup> max. 20 Hz to 55 Hz, 5.9 m/s <sup>2</sup> (200 V: 45 kW or more, 400 V: 55 kW or more) or 2.0 m/s <sup>2</sup> max. (200 V: 55 kW or less, 400 V: 75 kW or less)
Standards Compliant	UL 508C, EN61800-3, EN61800-5-1, EN954-1 Cat. 3, ISO 13849-1 (Cat. 3, PLd), IEC/EN61508 SIL2	
Protection Design	IP00 open-chassis, NEMA Type 1 enclosure	

\*1: Currently developing PM motor compatibility for drives 450 kW and above (CIMR-AA4A0930/AA4A1200).

\*2: Requires a drive with recommended capacity.

\*3: Speed control accuracy may vary slightly depending on installation conditions or motor used. Contact Yaskawa for details.

\*4: Momentary average deceleration torque refers to the deceleration torque from 60 Hz down to 0 Hz. This may vary depending on the motor.

\*5: If L3-04 is enabled when using a braking resistor or braking resistor unit, the motor may not stop within the specified deceleration time.

\*6: Overload protection may be triggered when operating with 150% of the rated output current if the output frequency is less than 6 Hz.

\*7: Varies in accordance with drive capacity and load. Drives with a capacity of smaller than 11 kW in the 200 V (model: CIMR-AA2A0056) or 400 V (model: CIMR-AA4A0031) require a separate Momentary Power Loss Recovery Unit to continue operating during a momentary power loss of 2 s or longer.

\*8: Protection may not be provided under the following conditions as the motor windings are grounded internally during run:

- Low resistance to ground from the motor cable or terminal block.
- Drive already has a short-circuit when the power is turned on.



# Standard Connection Diagram

## Standard Connection Diagram

Example: 200 V Class 3.7 kW

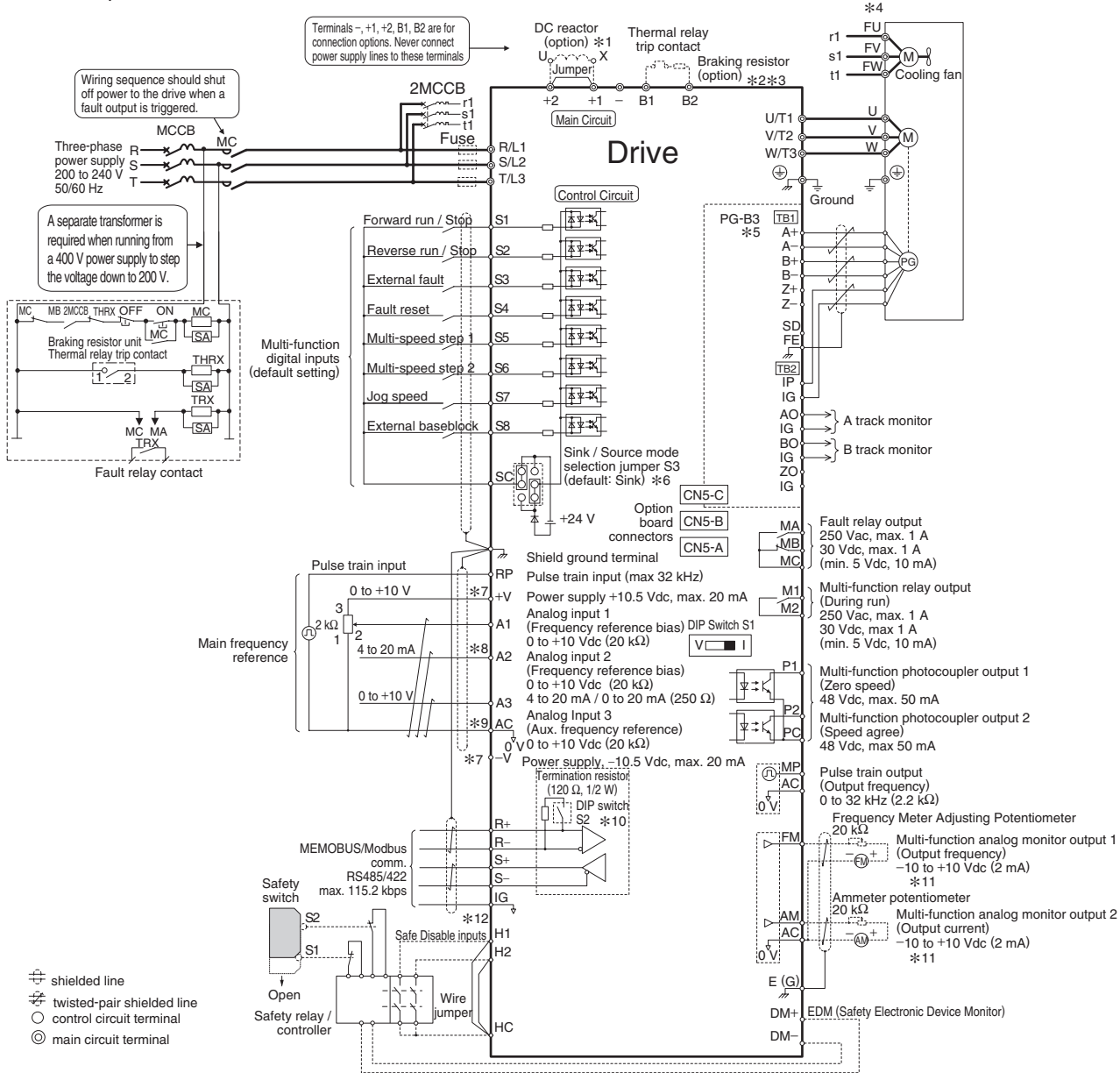

- \*1: Remove the jumper when installing a DC reactor. Certain models come with a built-in DC reactor: CIMR-2A0110 and above, CIMR-4A0058 and above.
- \*2: Make sure Stall Prevention is disabled (L3-04 = 0) whenever using a braking resistor. If left enabled, the drive may not stop within the specified deceleration time.
- \*3: Enable the drive's braking resistor overload protection by setting L8-01 = 1 when using ERF type braking resistors. Wire the thermal overload relay between the drive and the braking resistor and connect this signal to a drive digital input. Use this input to trigger a fault in the drive in case of a braking resistor overload.
- \*4: Self-cooling motors do not require wiring that would be necessary with motors using a cooling fan.
- \*5: For control modes that do not use a motor speed feedback signal, PG option card wiring is not necessary.
- \*6: This figure shows an example of a sequence input to S1 through S8 using a non-powered relay or an NPN transistor (0 V common/sink mode: default). When sequence connections by PNP transistor (+24 V common/source mode) or preparing an external +24 V power supply, refer to A1000 Technical Manual for details.
- \*7: The maximum output current capacity for the +V and -V terminals on the control circuit is 20 mA. Never short terminals +V, -V, and AC, as this can cause erroneous operation or damage the drive.
- \*8: Set DIP switch S1 to select between a voltage or current input signal to terminal A2. The default setting is for voltage input.
- \*9: Never connect to the AC terminal ground or chassis. This can result in erroneous operation or cause a fault.
- \*10: Enable the termination resistor in the last drive in a MEMOBUS/Modbus network by setting DIP switch S2 to the ON position.
- \*11: Monitor outputs work with devices such as analog frequency meters, ammeters, voltmeters, and wattmeters. Do not use these outputs in a feedback loop.
- \*12: Disconnect the wire jumper between HC - H1 and HC - H2 when utilizing the Safe Disable input.
  - The sink/source setting for the Safe Disable input is the same as with the sequence input. Jumper S3 has the drive set for an external power supply. When not using the Safe Disable input feature, remove the jumper shorting the input and connect an external power supply.
  - Time from input open to drive output stop is less than 1 ms. The wiring distance for the Safe Disable inputs should not exceed 30 m.

Note: When an Application Preset is selected, the drive I/O terminal functions change.

### Control Circuit and Serial Communication Circuit Terminal Layout

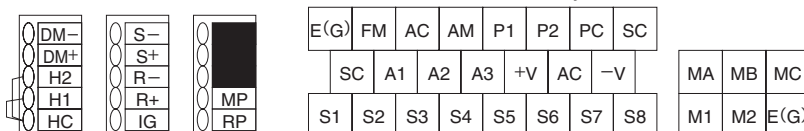

# Terminal Functions

## Main Circuit Terminals

Max. Applicable Motor Capacity indicates Heavy Duty

Voltage	200 V			400 V		
Model CIMR-AA:.....	2A0004 to 2A0081	2A0110, 2A0138	2A0169 to 2A0415	4A0002 to 4A0044	4A0058, 4A0072	4A0088 to 4A1200
Max. Applicable Motor Capacity kW	0.4 to 18.5	22, 30	37 to 110	0.4 to 18.5	22, 30	37 to 560
R/L1, S/L2, T/L3	Main circuit input power supply			Main circuit input power supply		
U/T1, V/T2, W/T3	Drive output			Drive output		
B1, B2	Braking resistor unit		—	Braking resistor unit		—
—	· DC reactor (+1, +2)	DC power supply (+1, -)*	DC power supply (+1, -)* Braking unit (+3, -)	· DC reactor (+1, +2)	DC power supply (+1, -)*	DC power supply (+1, -)* Braking unit (+3, -)
+1	· DC power supply (+1, -)*			· DC power supply (+1, -)*		
+2	—			—		
+3	—			—		
⊕	Ground terminal (100 Ω or less)			Ground terminal (10 Ω or less)		

\* DC power supply input terminals (+1, -) are not UL/cUL and CE certified.

## Control Circuit Input Terminals (200 V/400 V Class)

Terminal Type	Terminal	Signal Function	Description	Signal Level
Multi-Function Digital Input	S1	Multi-function input selection 1	Closed: Forward run (default) Open: Stop (default)	Photocoupler 24 Vdc, 8 mA
	S2	Multi-function input selection 2	Closed: Reverse run (default) Open: Stop (default)	
	S3	Multi-function input selection 3	External fault, N.O. (default)	
	S4	Multi-function input selection 4	Fault reset (default)	
	S5	Multi-function input selection 5	Multi-step speed reference 1 (default)	
	S6	Multi-function input selection 6	Multi-step speed reference 2 (default)	
	S7	Multi-function input selection 7	Jog frequency (default)	
	S8	Multi-function input selection 8	Closed: External baseblock	
	SC	Multi-function input selection common	Multi-function input selection common	
Main Frequency Reference Input	RP	Multi-function pulse train input	Frequency reference (default) (H6-01 = 0)	0 to 32 kHz (3 kΩ)
	+V	Setting power supply	+10.5 V power supply for analog reference (20 mA max.)	
	-V	Setting power supply	-10.5 V power supply for analog reference (20 mA max.)	
	A1	Multi-function analog input 1	-10 to +10 Vdc for -100 to 100%, 0 to +10 Vdc for 0 to 100% (impedance 20 kΩ), Main frequency reference (default)	
	A2	Multi-function analog input 2	DIP switch S1 sets the terminal for a voltage or current input signal -10 to +10 Vdc for -100 to +100%, 0 to +10 Vdc for 0 to 100% (impedance 20 kΩ) 4 to 20 mA for 0 to 100%, 0 to 20 mA for 0 to 100% (impedance 250 Ω) Added to the reference value of the analog frequency for the main frequency reference (default)	
	A3	Multi-function analog input 3	-10 to +10 Vdc for -100 to +100%, 0 to +10 Vdc for 0 to 100% (impedance 20 kΩ) Auxiliary frequency reference (default)	
	AC	Frequency reference common	0 V	
	E(G)	Connection to wire shielding and option card ground wire	—	
Multi-Function Photocoupler Output	P1	Multi-function photocoupler output (1)	Zero speed (default)	48 Vdc, 2 to 50 mA Photocoupler output*1
	P2	Multi-function photocoupler output (2)	Speed agree (default)	
	PC	Photocoupler output common	—	
Fault Relay Output	MA	N.O. output	Closed: Fault	Relay output 250 Vac, 10 mA to 1 A, 30 V, 10 mA to 1 A Minimum load: 5 Vdc, 10 mA
	MB	N.O. output	Open: Fault	
	MC	Digital output common	—	
Multi-Function Digital Output*2	M1	Multi-function digital output	During run (default)	Minimum load: 5 Vdc, 10 mA
	M2		Closed: During run	
Monitor Output	MP	Pulse train input	Output frequency (default) (H6-06 = 102)	0 to 32 kHz (2.2 kΩ)
	FM	Multi-function analog monitor (1)	Output frequency (default)	0 to +10 Vdc for 0 to 100%
	AM	Multi-function analog monitor (2)	Output current (default)	-10 to 10 Vdc for -100 to 100%
	AC	Analog common	0 V	
Safety Input	H1	Safety input 1	24 Vdc 8 mA. One or both open: Output disabled. Both closed: Normal operation.	
	H2	Safety input 2	Internal impedance 3.3 kΩ, switching time at least 1 ms.	
	HC	Safety input common	Safety input common	
Safety Monitor Output	DM+	Safety monitor output	Outputs status of Safe Disable function. Closed	48 Vdc, 50 mA or less
	DM-	Safety monitor output common	when both Safe Disable channels are closed.	

\*1: Connect a flywheel diode as shown below when driving a reactive load such as a relay coil. Diode must be rated higher than the circuit voltage.

\*2: Refrain from assigning functions to terminals M1 and M2 that involve frequent switching, as doing so may shorten relay performance life. Switching life is estimated at 200,000 times (assumes 1 A, resistive load).

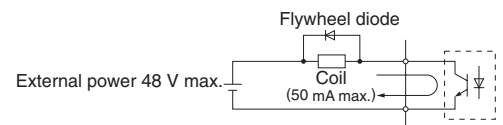

## Serial Communication Terminals (200 V/400 V Class)

Classification	Terminal	Signal Function	Description	Signal Level
MEMOBUS/Modbus Communications	R+	Communications input (+)	MEMOBUS/Modbus communications: Use a RS-485 or RS-422 cable to connect the drive.	RS-422/485 MEMOBUS/Modbus communications protocol 115.2 kbps (max.)
	R-	Communications input (-)		
	S+	Communications output (+)		
	S-	Communications output (-)		
	IG	Shield ground		

## Enclosures

Enclosures of standard products vary depending on the model. Refer to the table below.

### 200 V Class

ND : Normal Duty, HD : Heavy Duty

Model CIMR-AA2A	0004	0006	0008	0010	0012	0018	0021	0030	0040	0056	0069	0081	0110	0138	0169	0211	0250	0312	0360	0415
Max. Applicable	ND 0.75	1.1	1.5	2.2	3	3.7	5.5	7.5	11	15	18.5	22	30	37	45	55	75	90	110	110
Motor Capacity (kW)	HD 0.4	0.75	1.1	1.5	2.2	3	3.7	5.5	7.5	11	15	18.5	22	30	37	45	55	75	90	110
Enclosure Panel [NEMA Type 1]	Standard												Made to order						*	
Open-Chassis [IP00]	Without top and bottom covers												Standard						Order-made	

\* NEMA 1 Type 1 is not available for this capacity.

### 400 V Class

ND : Normal Duty, HD : Heavy Duty

Model CIMR-AA4A	0002	0004	0005	0007	0009	0011	0018	0023	0031	0038	0044	0058	0072	0088	0103	0139	0165	0208	0250	0296	0362	0414	0515	0675	0930	1200
Max. Applicable	ND 0.75	1.5	2.2	3	3.7	5.5	7.5	11	15	18.5	22	30	37	45	55	75	90	110	132	160	185	220	250	355	500	630
Motor Capacity (kW)	HD 0.4	0.75	1.5	2.2	3	3.7	5.5	7.5	11	15	18.5	22	30	37	45	55	75	90	110	132	160	185	220	315	450	560
Enclosure Panel [NEMA Type 1]	Standard												Made to order						*							
Open-Chassis [IP00]	Without top and bottom covers												Standard						Order-made							

\* NEMA 1 Type 1 is not available for this capacity.

### Enclosure Panel [NEMA Type 1]

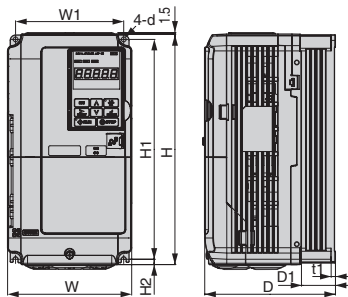

Figure 1

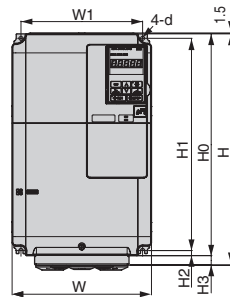

Figure 2

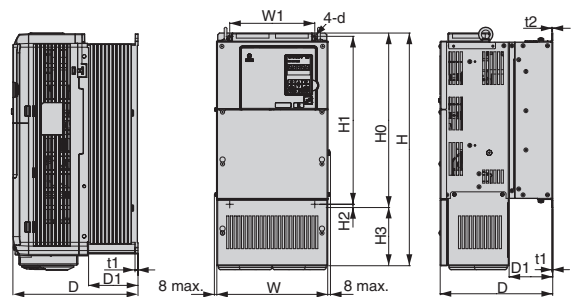

Figure 3

### 200 V Class

Model CIMR-AA2A	Max. Applicable Motor Capacity (kW)		Figure	Dimensions (mm)											Weight (kg)	Cooling					
	Normal Duty	Heavy Duty		W	H	D	W1	H0	H1	H2	H3	D1	t1	t2			d				
0004	0.75	0.4	1	140	260	147	122	-	248	6	-	38	5	-	M5	3.1	Self cooling				
0006	1.1	0.75																3.2			
0008	1.5	1.1																	3.5		
0010	2.2	1.5																		4.0	
0012	3.0	2.2																			5.6
0018	3.7	3.0																			
0021	5.5	3.7		9.7																	
0030	7.5	5.5			23																
0040	11	7.5				28															
0056	15	11					41														
0069	18.5	15						42													
0081	22	18.5							83												
0110	30	22	88																		
0138	37	30		108																	
0169	45	37			-																
0211	55	45				-															
0250	75	55					-														
0312	90	75						-													
0360	110	90	-																		

### 400 V Class

Model CIMR-AA4A	Max. Applicable Motor Capacity (kW)		Figure	Dimensions (mm)											Weight (kg)	Cooling					
	Normal Duty	Heavy Duty		W	H	D	W1	H0	H1	H2	H3	D1	t1	t2			d				
0002	0.75	0.4	1	140	260	147	122	-	248	6	-	38	5	-	M5	3.2	Self cooling				
0004	1.5	0.75																3.4			
0005	2.2	1.5																	3.5		
0007	3.0	2.2																		3.9	
0009	3.7	3.0																			5.4
0011	5.5	3.7																			
0018	7.5	5.5		8.3																	
0023	11	7.5			23																
0031	15	11				27															
0038	18.5	15					39														
0044	22	18.5						45													
0058	30	22							46												
0072	37	30	87																		
0088	45	37		106																	
0103	55	45			112																
0139	75	55				117															
0165	90	75					-														
0208	110	90						-													
0250	132	110	-																		
0296	160	132		-																	
0362	185	160			-																

■ Open-Chassis (IP00)

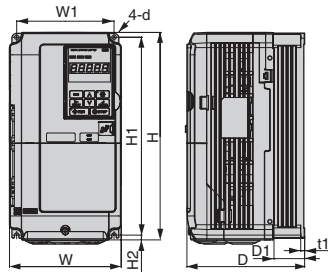

Figure 1

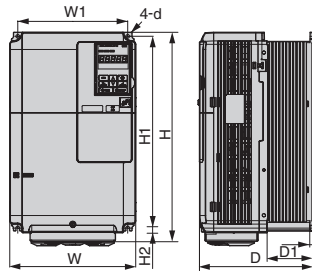

Figure 2

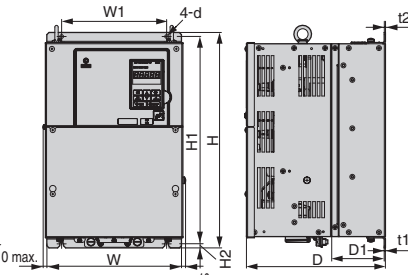

Figure 3

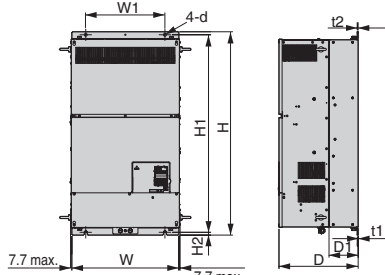

Figure 4

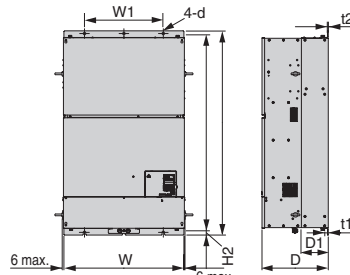

Figure 5

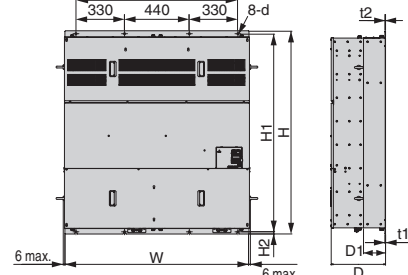

Figure 6

200 V Class

Model	Max. Applicable Motor Capacity (kW)		Figure	Dimensions (mm)										Weight (kg)	Cooling																						
	CIMR-AA2A	Normal Duty		Heavy Duty	W	H	D	W1	H1	H2	D1	t1	t2			d																					
0004	0.75	0.4	1	140	260	147	122	248	6	38	5	-	M5	3.1	Self cooling																						
0006	1.1	0.75												3.2																							
0008	1.5	1.1												140		260	164	122	248	6	55	5	-	M5	3.5	Fan cooled											
0010	2.2	1.5																							4												
0012	3	2.2																							167		122	248	6	75	5	-	M5	5.6			
0018	3.7	3																																5.7			
0021	5.5	3.7																							180		300	187	160	284	8	78	5	-	M5	8.7	Fan cooled
0030	7.5	5.5																																		9.7	
0040	11	7.5																							220		350	197	192	335	8	78	5	-	M6	21	Fan cooled
0056	15	11																																		25	
0069	18.5	15	220	365	197	192	335	8	78	5	-	M6	25	Fan cooled																							
0081	22	18.5											37																								
0110	30	22	250	400	258	195	385	7.5	100	2.3	2.3	M6	37	Fan cooled																							
0138	37	30											38																								
0169	45	37	325	550	283	260	535	7.5	110	2.3	2.3	M6	76	Fan cooled																							
0211	55	45											80																								
0250	75	55	450	705	330	325	680	12.5	130	3.2	3.2	M10	98	Fan cooled																							
0312	90	75											99																								
0360	110	90	500	800	350	370	773	13	130	4.5	4.5	M12	99	Fan cooled																							
0415	110	110																																			

400 V Class

Model	Max. Applicable Motor Capacity (kW)		Figure	Dimensions (mm)										Weight (kg)	Cooling																						
	CIMR-AA4A	Normal Duty		Heavy Duty	W	H	D	W1	H1	H2	D1	t1	t2			d																					
0002	0.75	0.4	1	140	260	147	122	248	6	38	5	-	M5	3.2	Self cooling																						
0004	1.5	0.75												3.4																							
0005	2.2	1.5												140		260	164	122	248	6	55	5	-	M5	3.5	Fan cooled											
0007	3	2.2																							167		122	248	6	75	5	-	M5	3.9			
0009	3.7	3																																5.4			
0011	5.5	3.7																							180		300	187	160	284	8	78	5	-	M5	5.7	Fan cooled
0018	7.5	5.5																																		8.3	
0023	11	7.5																							220		350	197	192	335	8	78	5	-	M6	21	Fan cooled
0031	15	11																																		25	
0038	18.5	15																							220		365	197	192	335	8	78	5	-	M6	25	Fan cooled
0044	22	18.5	36																																		
0058	30	22	250	400	258	195	385	7.5	100	2.3	2.3	M6	41	Fan cooled																							
0072	37	30											42																								
0088	45	37	325	510	258	260	495	7.5	105	2.3	3.2	M6	79	Fan cooled																							
0103	55	45											96																								
0139	75	55	325	550	283	260	535	7.5	110	2.3	2.3	M6	102	Fan cooled																							
0165	90	75											107																								
0208	110	90	450	705	330	325	680	12.5	130	3.2	3.2	M10	125	Fan cooled																							
0250	132	110																																			
0296	160	132	500	800	350	370	773	13	130	4.5	4.5	M12	221	Fan cooled																							
0362	185	160																																			
0414	220	185	500	950	370	370	923	13	135	4.5	4.5	M12	545	Fan cooled																							
0515	250	220											555																								
0675	355	315	670	1140	370	440	1110	15	150	4.5	4.5	M12		Fan cooled																							
0930	500	450																																			
1200	630	560	1250	1380	370	1100	1345	15	150	4.5	4.5	M12		Fan cooled																							





## Attachment for External Heatsink

Additional attachments are required to install the following models: CIMR-AA2A0004 to 0081, CIMR-AA4A0002 to 0044. The final product will be wider and taller than the drive. Additional attachments are required for CIMR-AA2A0110 and above, CIMR-AA4A0058 and above.

Note: Contact Yaskawa for information on attachments for earlier models.

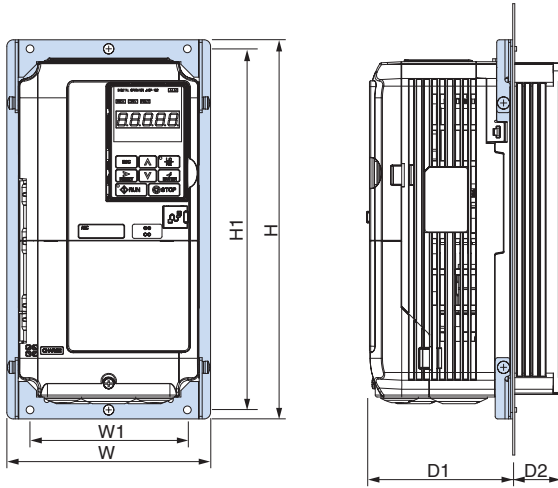

## 200 V Class

Model CIMR-AA2A:.....	Dimension (mm)						Code No.	
	W	H	W1	H1	D1	D2		
2A0004	158	294	122	280	109	36.4	EZZ020800A	
2A0006								
2A0008								
2A0010								
2A0012					109	53.4		EZZ020800B
2A0018								
2A0021					112	53.4		
2A0030								
2A0040	198	329	160	315	112	73.4	EZZ020800C	
2A0056								
2A0069								
2A0081	238	380	192	362	119	76.4	EZZ020800D	

## 400 V Class

Model CIMR-AA4A:.....	Dimension (mm)						Code No.	
	W	H	W1	H1	D1	D2		
4A0002	158	294	122	280	109	36.4	EZZ020800A	
4A0004								
4A0005					109	53.4		EZZ020800B
4A0007								
4A0009								
4A0011								
4A0018					112	53.4		
4A0023								
4A0031	198	329	160	315	112	53.4	EZZ020800C	
4A0038								
4A0044	238	380	192	362	119	76.4	EZZ020800D	

## Panel Modification for External Heatsink

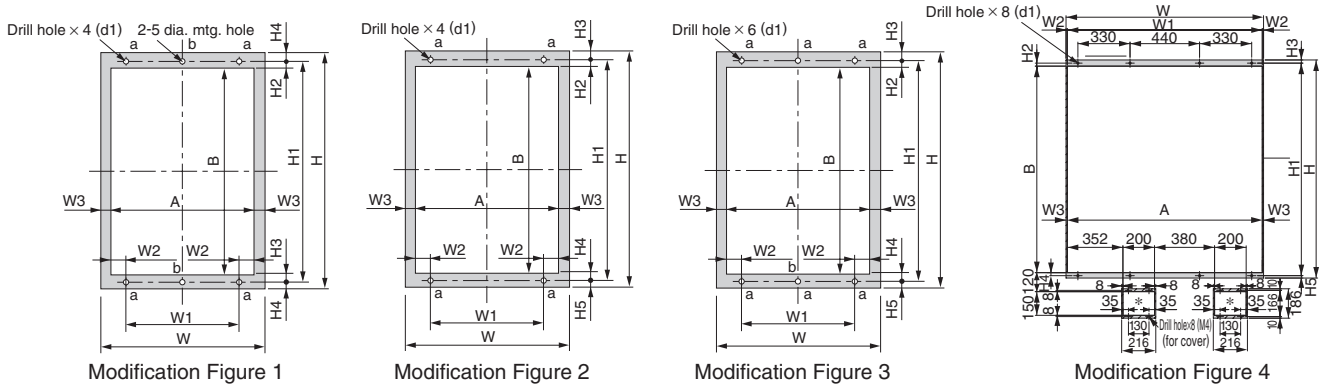

\* Panel opening needed to replace an air filter installed to the bottom of the drive. The opening should be kept as small as possible.

## 200 V Class

Model CIMR-AA:.....	Modification Figure	Dimensions (mm)											d1															
		W	H	W1	W2	W3	H1	H2	H3	H4	H5	A		B														
2A0004	1	158	294	122	9	9	280	8.5	8.5	7	-	140	263	M5														
2A0006																												
2A0008																												
2A0010																												
2A0012																												
2A0018																												
2A0021																												
2A0030																												
2A0040																												
2A0056															2	198	329	160	10	9	315	17.5	10.5	7	-	180	287	M5
2A0069																												
2A0081																												
2A0110	250	400	195	19.5	8	385	8	7.5	8	7.5	234	369	M6															
2A0138																												
2A0169	2	325	550	260	24.5	8	535	8	7.5	8	7.5	309	519	M6														
2A0211																												
2A0250															450	705	325	54.5	8	680	12.5	12.5	12.5	12.5	434	655	M10	
2A0312																												
2A0360															500	800	370	57	8	773	16	14	17	13	484	740	M12	
2A0415																												

## 400 V Class



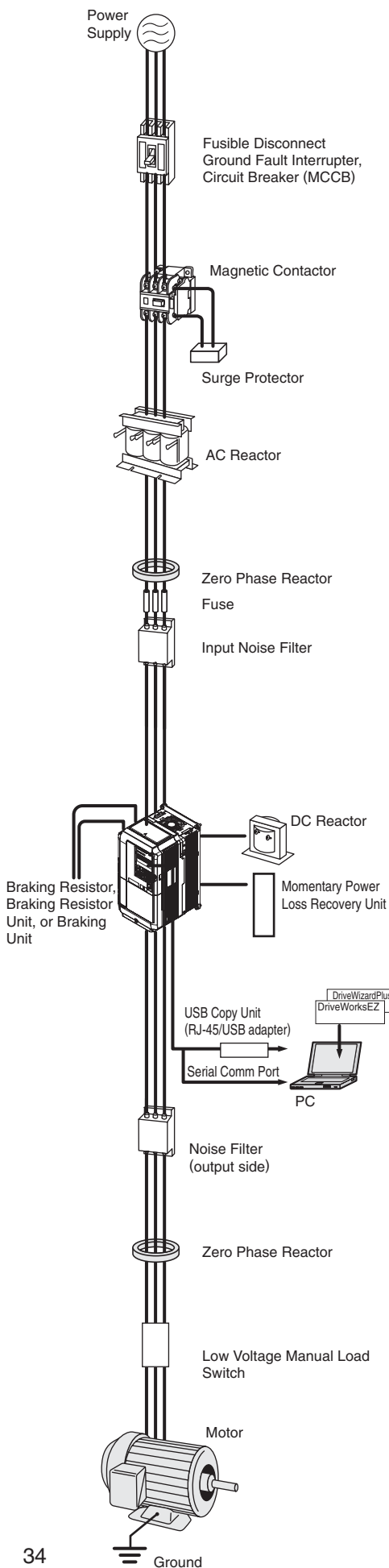







Model CIMR-AA:.....	Modification Figure	Dimensions (mm)											d1															
		W	H	W1	W2	W3	H1	H2	H3	H4	H5	A		B														
4A0002	1	158	294	122	9	9	280	8.5	8.5	7	-	140	263	M5														
4A0004																												
4A0005																												
4A0007																												
4A0009																												
4A0011																												
4A0018																												
4A0023																												
4A0031															2	198	329	160	10	9	315	17.5	10.5	7	-	180	287	M5
4A0038																												
4A0044																												
4A0058																												
4A0072	2	275	450	220	19.5	8	385	8	7.5	8	7.5	234	369	M6														
4A0088																												
4A0103															325	510	260	24.5	8	495	8	7.5	8	7.5	309	479	M6	
4A0139																												
4A0165															450	705	325	54.5	8	680	12.5	12.5	12.5	12.5	434	655	M10	
4A0208																												
4A0250															500	800	370	57	8	773	16	14	17	13	484	740	M12	
4A0296																												
4A0362	500	950	370	57	8	923	16	14	17	13	484	890	M12															
4A0414																												
4A0515	3	670	1140	440	107	8	1110	19	15	19	15	654	1072	M12														
4A0675	4	1250	1380	1100	67	8	1345	19	20	19	15	1234	1307	M12														
4A0930																												
4A1200																												



Name	Purpose	Model, Manufacturer	Page
Ground Fault Interrupter (GFI)	Protects the drive from ground faults that could otherwise result in electric shock or fire. Choose a GFI designed to minimize harmonics specifically for AC drives. Should have a current rating of at least 30 mA.	Recommended: NV series by Mitsubishi Electric Corporation EG, SG series by Fuji Electric FA Components & Systems Co., Ltd	—
Circuit Breaker	Protects circuitry from excessive current. A circuit breaker should be installed between the main power supply and an AC reactor.	Recommended: NF series by Mitsubishi Electric Corporation	36
Magnetic Contactor	Interrupts the power supply to the drive. In addition to protecting drive circuitry, a magnetic contactor also prevents damage to a braking resistor if used.	Recommended: SC series by Fuji Electric FA Components & Systems Co., Ltd	36
Surge Protector	Absorbs the voltage surge from switching of electro-magnetic contactors and control relays. Install a surge protector to the magnetic contactors and control relays as well as magnetic valves and magnetic braking coil.	DCR2 series RFN series by Nippon Chemicon Corporation	37
DC Reactor	Improve the input power ratio of the drive. The DC reactor is a built-in model of 22 kW or more. Option: 18.5 kW or less.	UZDA series	38
AC Reactor	· Used for harmonic current suppression and total improving power factor. · Should be used if the power supply capacity is larger than 600 kVA. · Suppresses harmonic current · Improves the power factor of the input power supply	UZBA series	40
Zero Phase Reactor	Reduces noise from the line that enters into the drive input power system. Should be installed as close as possible to the drive. Can be used on both the input and output sides.	F6045GB F11080GB by Hitachi Metals, Ltd.	42
Fuse / Fuse Holder	Protects internal circuitry in the event of component failure. Fuse should be connected to the input terminal of the drive. Note: Refer to the instruction manual for information on UL approval.	CR2LS series CR6L series CM, CMS series by Fuji Electric FA Components & Systems Co., Ltd	43
Capacitor-Type Noise Filter	Reduces noise from the line that enters into the drive input power system. The noise filter can be used in combination with a zero-phase reactor. Note: Available for drive input only. Do not connect the noise filter to the output terminals.	3XYG 1003 by Okaya Electric Industries Co., Ltd.	43
Input Noise Filter	Reduces noise from the line that enters into the drive input power system. Should be installed as close as possible to the drive. Note: For CE Marking (EMC Directive) compliant models, refer to A1000 Technical Manual.	LNFD series LNFB series FN series	44
Output Noise Filter	Reduces noise from the line that enters into the drive input power system. Should be installed as close as possible to the drive.	LF series by NEC Tokin Corporation	46
Braking Resistor	Used to shorten the deceleration time by dissipating regenerative energy through a resistor. Usage 3% ED, requires a separate attachment.	ERF-150WJ series CF120-B579 series	48
Attachment for Braking Resistor	A braking resistor can be attached to the drive.	EZZ020805A	51
Braking Resistor Unit	Used to shorten the deceleration time by dissipating regenerative energy through a resistor unit (10% ED). A thermal overload relay is built in (10% ED).	LKEB series	48
Braking Unit	Shortened deceleration time results when used with a Braking Resistor Unit.	CDBR series	48
24 V Power Supply	Provides power supply for the control circuit and option boards. Note: Parameter settings cannot be changed when the drive is operating solely from this power supply.	PS-A10H PS-A10L	47
VS System Module	System control device that enables optimum system configuration by combining modules for automatic control system.	JGSM series	52
USB Copy Unit (RJ-45/USB compatible plug)	· Can copy parameter settings easily and quickly to be later transferred to another drive. · Adapter for connecting the drive to the USB port of a PC	JVOP-181	55
Support Tools USB Cable	Connect the drive and PC when using DriveWizard or DriveWorksEZ. The cable length must be 3 m or less.	Commercially available USB2.0 A/B cable.	—
LCD Operator	For easier operation when using the optional LCD operator. Allows for remote operation. Includes a Copy function for saving drive settings.	JVOP-180	54
LCD Operator Extension Cable	Cable for connecting the LCD operator.	WV001: 1 m WV003: 3 m	54
Momentary Power Loss Recovery Unit	Ensures continuous drive operation for a power loss of up to 2 s.	P0010 Type (200 V class) P0020 Type (400 V class)	47
Frequency Meter, Current Meter	Allows the user to set and monitor the frequency, current, and voltage using an external device.	DCF-6A	56
Variable Resistor Board (20 kΩ)		ETX003120	56
Frequency Setting Potentiometer (2 kΩ)		RH000739	56
Frequency Meter Adjusting Potentiometer (20 kΩ)		RH000850	56
Control Dial for Frequency Setting Potentiometer		CM-3S	56
Output Voltage Meter		SCF-12NH	57
Attachment for External Heatsink		Required for heatsink installation. Current derating may be needed when using a heatsink.	—
Low Voltage Manual Load Switch	Prevents shock from the voltage created on the terminals board from a coasting synchronous motor.	Recommended: AICUT, LB series by Aichi Electric Works Co., Ltd	—

Note: Contact the manufacturer in question for availability and specifications of non-Yaskawa products.

## Option Cards

Type	Name	Model	Function	Manual No.
Speed Reference Card	Analog Input 	AI-A3	Enables high-precision and high-resolution analog speed reference setting. · Input signal level: –10 to +10 Vdc (20 kΩ) 4 to 20 mA (500 Ω) · Input channels: 3 channels, DIP switch for input voltage/input current selection · Input resolution: Input voltage 13 bit signed (1/8192) Input current 1/6554	TOBPC73060038
	Digital Input 	DI-A3	Enables 16-bit digital speed reference setting. · Input signal: 16 bit binary, 2 digit BCD + sign signal + set signal · Input voltage: +24 V (isolated) · Input current: 8 mA User-set: 8 bit, 12 bit, 16 bit	TOBPC73060039
Communications Option Card	DeviceNet Interface 	SI-N3	Used for running or stopping the drive, setting or referencing parameters, and monitoring output frequency, output current, or similar items through DeviceNet communication with the host controller.	TOBPC73060043 SIEPC73060043
	CC-Link Interface 	SI-C3	Used for running or stopping the drive, setting or referencing parameters, and monitoring output frequency, output current, or similar items through CC-Link communication with the host controller.	TOBPC73060044 SIEPC73060044
	PROFIBUS-DP Interface 	SI-P3	Used for running or stopping the drive, setting or referencing parameters, and monitoring output frequency, output current, or similar items through CANopen communication with the host controller.	TOBPC73060042 SIEPC73060042
	CANopen Interface 	SI-S3	Used for running or stopping the drive, setting or referencing parameters, and monitoring output frequency, output current, or similar items through CANopen communication with the host controller.	TOBPC73060045 SIEPC73060045
	MECHATROLINK-II Interface SI-T3 	SI-T3	Used for running or stopping the drive, setting or referencing parameters, and monitoring output frequency, output current, or similar items through MECHATROLINK-II communication with the host controller.	TOBPC73060050 SIEPC73060050
	LONWORKS Interface	Available soon	Used for HVAC control, running or stopping the drive, setting or referencing parameters, and monitoring output current, watt-hours, or similar items through LONWORKS communications with the host controller.	–
	Monitor Option Card	Analog Monitor 	AO-A3	Outputs analog signal for monitoring drive output state (output freq., output current etc.). · Output resolution: 11 bit signed (1/2048) · Output voltage: –10 to +10 Vdc (non-isolated) · Terminals: 2 analog outputs
Digital Output 		DO-A3	Outputs isolated type digital signal for monitoring drive run state (alarm signal, zero speed detection, etc.) · Terminals: 6 photocoupler outputs (48 V, 50 mA or less) 2 relay contact outputs (250 Vac, 1 A or less 30 Vdc, 1 A or less)	TOBPC73060041
PG Speed Controller Card	Complimentary Type PG 	PG-B3	For control modes requiring a PG encoder for motor feedback. · Phase A, B, and Z pulse (3-phase) inputs (complementary type) · Max. input frequency: 50 kHz · Pulse monitor output: Open collector, +24 V, max. current 30 mA · Power supply output for PG: +12 V, max. current 200 mA	TOBPC73060036
	Line Driver PG 	PG-X3	For control modes requiring a PG encoder for motor feedback. · Phase A, B, and Z pulse (differential pulse) inputs (RS-422) · Max. input frequency: 300 kHz · Pulse monitor output: RS-422 · Power supply output for PG: +5 V or +12 V, max. current 200 mA	TOBPC73060037

Note: 1. Each communication option card requires a separate configuration file to link to the network.  
2. PG speed controller card is required for PG control.

### Circuit Breaker, Magnetic Contactor

Base device selection on motor capacity.



Circuit Breaker  
[Mitsubishi Electric Corporation]

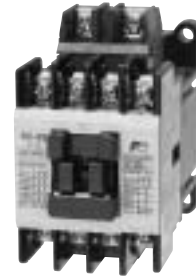

Magnetic Contactor  
[Fuji Electric FA Components & Systems Co., Ltd.]

#### 200 V Class

Motor Capacity (kW)	Circuit Breaker				Magnetic Contactor			
	Without Reactor		With Reactor		Without Reactor		With Reactor	
	Model	Rated Current (A)	Model	Rated Current (A)	Model	Rated Current (A)	Model	Rated Current (A)
0.4	NF32	5	NF32	5	SC-03	11	SC-03	11
0.75	NF32	10	NF32	10	SC-05	13	SC-03	11
1.5	NF32	15	NF32	10	SC-4-0	18	SC-05	13
2.2	NF32	20	NF32	15	SC-N1	26	SC-4-0	18
3.7	NF32	30	NF32	20	SC-N2	35	SC-N1	26
5.5	NF63	50	NF63	40	SC-N2S	50	SC-N2	35
7.5	NF125	60	NF63	50	SC-N3	65	SC-N2S	50
11	NF125	75	NF125	75	SC-N4	80	SC-N4	80
15	NF250	125	NF125	100	SC-N5	93	SC-N4	80
18.5	NF250	150	NF250	125	SC-N5	93	SC-N5	93
22	—	—	NF250	150	—	—	SC-N6	125
30	—	—	NF250	175	—	—	SC-N7	152
37	—	—	NF250	225	—	—	SC-N8	180
45	—	—	NF400	250	—	—	SC-N10	220
55	—	—	NF400	300	—	—	SC-N11	300
75	—	—	NF400	400	—	—	SC-N12	400
90	—	—	NF630	500	—	—	SC-N12	400
110	—	—	NF630	600	—	—	SC-N14	600

Note: To improve the input power factor, 200 V class drives larger than 22 kW come standard with a built-in DC reactor.

#### 400 V Class

Motor Capacity (kW)	Circuit Breaker				Magnetic Contactor			
	Without Reactor		With Reactor		Without Reactor		With Reactor	
	Model	Rated Current (A)	Model	Rated Current (A)	Model	Rated Current (A)	Model	Rated Current (A)
0.4	NF32	3	NF32	3	SC-03	7	SC-03	7
0.75	NF32	5	NF32	5	SC-03	7	SC-03	7
1.5	NF32	10	NF32	10	SC-05	9	SC-05	9
2.2	NF32	15	NF32	10	SC-4-0	13	SC-4-0	13
3.7	NF32	20	NF32	15	SC-4-1	17	SC-4-1	17
5.5	NF32	30	NF32	20	SC-N2	32	SC-N1	25
7.5	NF32	30	NF32	30	SC-N2S	48	SC-N2	32
11	NF63	50	NF63	40	SC-N2S	48	SC-N2S	48
15	NF125	60	NF63	50	SC-N3	65	SC-N2S	48
18.5	NF125	75	NF125	60	SC-N3	65	SC-N3	65
22	—	—	NF125	75	—	—	SC-N4	80
30	—	—	NF125	100	—	—	SC-N4	80
37	—	—	NF250	125	—	—	SC-N5	90
45	—	—	NF250	150	—	—	SC-N6	110
55	—	—	NF250	175	—	—	SC-N7	150
75	—	—	NF250	225	—	—	SC-N8	180
90	—	—	NF400	250	—	—	SC-N10	220
110	—	—	NF400	300	—	—	SC-N11	300
132	—	—	NF400	350	—	—	SC-N11	300
160	—	—	NF400	400	—	—	SC-N12	400
185	—	—	NF630	500	—	—	SC-N12	400
220	—	—	NF630	630	—	—	SC-N14	600
250	—	—	NF630	630	—	—	SC-N14	600
315	—	—	NF800	800	—	—	SC-N16	800
355	—	—	NF800	800	—	—	SC-N16	800
450	—	—	NF1000	1000	—	—	SC-N14 × 2*1	600*2
500	—	—	NF1250	1250	—	—	SC-N14 × 2*1	600*2
560	—	—	NF1600	1600	—	—	SC-N16 × 2*1	800*2
630	—	—	NF1600	1600	—	—	SC-N16 × 2*1	800*2

\*1: When two units are connected in parallel.

\*2: Rated current for a single unit.

Note: 400 V models 22 kW and above come with a built-in DC reactor that improves the power factor.

# Surge Protector

Dimensions (mm)

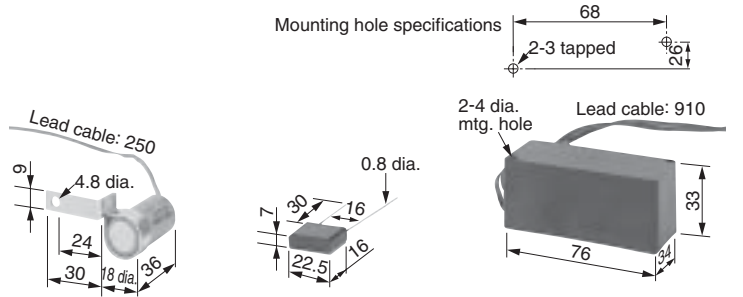

Weight: 22 g Model: DCR2-50A22E      Weight: 5 g Model: DCR2-10A25C      Weight: 150 g Model: RFN3AL504KD

[Nippon Chemi-Con Corporation]

## Product Line

Peripheral Devices			Surge Protector	Model	Specifications	Code No.
200 to 230 V	Control Relay	Large-Capacity Coil (other than relay)		DCR2-50A22E	220 Vac 0.5 $\mu$ F+200 $\Omega$	C002417
		MY2, MY3 [Omron Corporation] MM2, MM4 [Omron Corporation] HH22, HH23 [Fuji Electric FA Components & Systems Co., Ltd]		DCR2-10A25C	250 Vac 0.1 $\mu$ F+100 $\Omega$	C002482
		380 to 460 V		RFN3AL504KD	1000 Vdc 0.5 $\mu$ F+220 $\Omega$	C002630

### DC Reactor (UZDA-B for DC circuit)

Base device selection on motor capacity.

Lead Wire Type

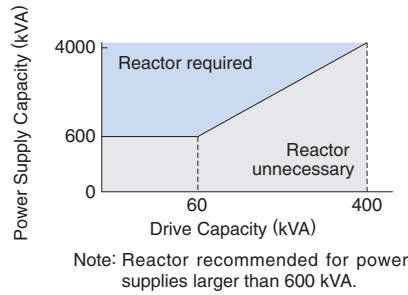
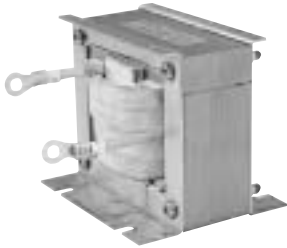

Connection Diagram

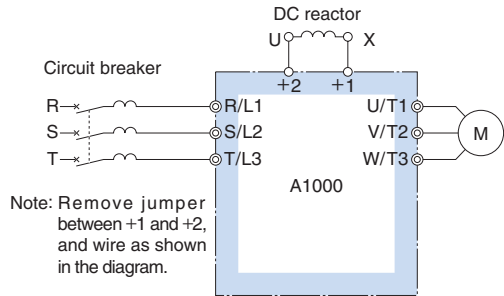

Dimensions (mm)

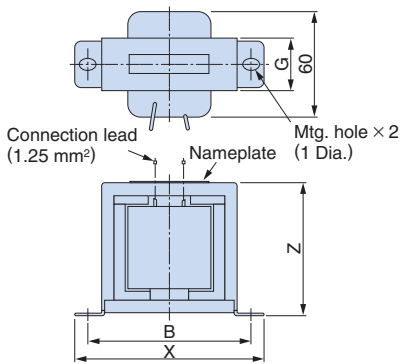

Figure 1

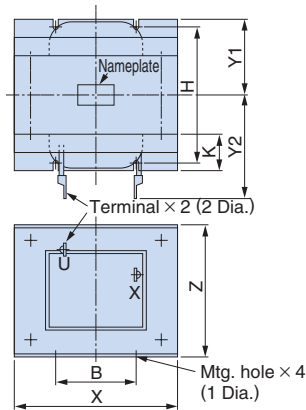

Figure 2

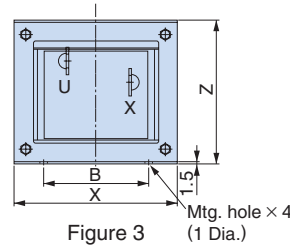
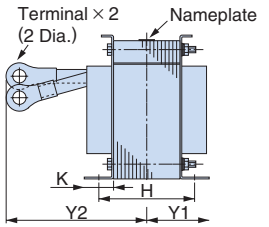

Figure 3



### 200 V Class

Motor Capacity (kW)	Current (A)	Inductance (mH)	Code No.	Figure	Dimensions (mm)								Weight (kg)	Watt Loss (W)	Wire Gauge*1 (mm²)		
					X	Y2	Y1	Z	B	H	K	G				1 Dia.	2 Dia.
0.4	5.4	8	X010048	1	85	—	—	53	74	—	—	32	M4	—	0.8	8	2
0.75	5.4	8	X010048	1	85	—	—	53	74	—	—	32	M4	—	0.8	8	2
1.5	18	3	X010049	2	86	80	36	76	60	55	18	—	M4	M5	2	18	5.5
2.2	18	3	X010049	2	86	80	36	76	60	55	18	—	M4	M5	2	18	5.5
3.7	18	3	X010049	2	86	80	36	76	60	55	18	—	M4	M5	2	18	5.5
5.5	36	1	X010050	2	105	90	46	93	64	80	26	—	M6	M6	3.2	22	8
7.5	36	1	X010050	2	105	90	46	93	64	80	26	—	M6	M6	3.2	22	8
11	72	0.5	X010051	2	105	105	56	93	64	100	26	—	M6	M8	4.9	29	30
15	72	0.5	X010051	2	105	105	56	93	64	100	26	—	M6	M8	4.9	29	30
18.5	90	0.4	X010176	2	133	120	52.5	117	86	80	25	—	M6	M8	6.5	45	30
22*2	105	0.3	300-028-140	3	133	120	52.5	117	86	80	25	—	M6	M10	8	55	50
22 to 110					Built-in												

\*1: Cable: Indoor PVC (75°C), ambient temperature 45°C, 3 lines max.

\*2: Select a motor of this capacity when using a CIMR-AA2A0081.

### 400 V Class

Motor Capacity (kW)	Current (A)	Inductance (mH)	Code No.	Figure	Dimensions (mm)								Weight (kg)	Watt Loss (W)	Wire Gauge*1 (mm²)		
					X	Y2	Y1	Z	B	H	K	G				1 Dia.	2 Dia.
0.4	3.2	28	X010052	1	85	—	—	53	74	—	—	32	M4	—	0.8	9	2
0.75	3.2	28	X010052	1	85	—	—	53	74	—	—	32	M4	—	0.8	9	2
1.5	5.7	11	X010053	1	90	—	—	60	80	—	—	32	M4	—	1	11	2
2.2	5.7	11	X010053	1	90	—	—	60	80	—	—	32	M4	—	1	11	2
3.7	12	6.3	X010054	2	86	80	36	76	60	55	18	—	M4	M5	2	16	2
5.5	23	3.6	X010055	2	105	90	46	93	64	80	26	—	M6	M5	3.2	27	5.5
7.5	23	3.6	X010055	2	105	90	46	93	64	80	26	—	M6	M5	3.2	27	5.5
11	33	1.9	X010056	2	105	95	51	93	64	90	26	—	M6	M6	4	26	8
15	33	1.9	X010056	2	105	95	51	93	64	90	26	—	M6	M6	4	26	8
18.5	47	1.3	X010177	2	115	125	57.5	100	72	90	25	—	M6	M6	6	42	14
22*2	56	1	300-028-141	3	133	105	52.5	117	86	80	25	—	M6	M6	7	50	22
22 to 630					Built-in												

\*1: Cable: Indoor PVC (75°C), ambient temperature 45°C, 3 lines max.

\*2: Select a motor of this capacity when using a CIMR-AA4A0044.



### Terminal Type

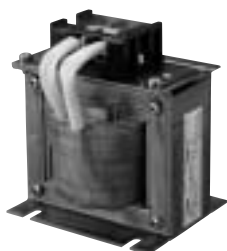

### Dimensions (mm)

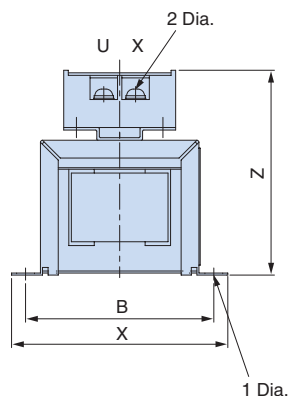

Figure 1

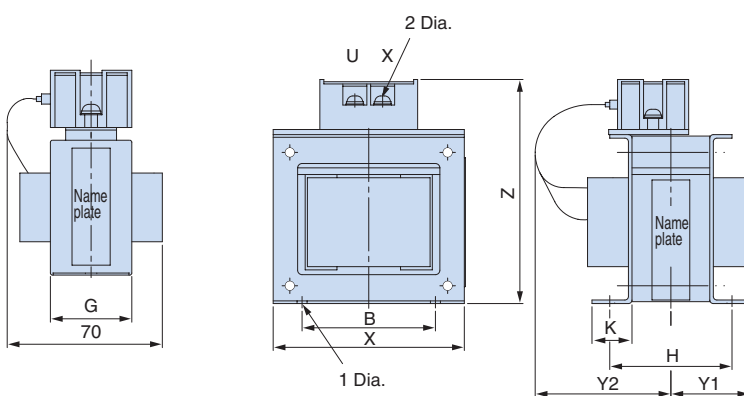

Figure 2

### 200 V Class

Motor Capacity (kW)	Current (A)	Inductance (mH)	Code No.	Figure	Dimensions (mm)								Weight (kg)	Watt Loss (W)		
					X	Y2	Y1	Z	B	H	K	G			1 Dia.	2 Dia.
0.4	5.4	8	300-027-130	1	85	-	-	81	74	-	-	32	M4	M4	0.8	8
0.75																
1.5	18	3	300-027-131	2	86	84	36	101	60	55	18	-	M4	M4	2	18
2.2																
3.7																
5.5	36	1	300-027-132	2	105	94	46	129	64	80	26	-	M6	M4	3.2	22
7.5																
11																
15	72	0.5	300-027-133	2	105	124	56	135	64	100	26	-	M6	M6	4.9	29
18.5					90	0.4	300-027-139	133	147.5	52.5	160	86	80	25		

### 400 V Class

Motor Capacity (kW)	Current (A)	Inductance (mH)	Code No.	Figure	Dimensions (mm)								Weight (kg)	Watt Loss (W)		
					X	Y2	Y1	Z	B	H	K	G			1 Dia.	2 Dia.
0.4	3.2	28	300-027-134	1	85	-	-	81	74	-	-	32	M4	M4	0.8	9
0.75																
1.5	5.7	11	300-027-135	1	90	-	-	88	80	-	-	32	M4	M4	1	11
2.2																
3.7	12	6.3	300-027-136	2	86	84	36	101	60	55	18	-	M4	M4	2	16
5.5																
7.5																
11	23	3.6	300-027-137	2	105	104	46	118	64	80	26	-	M6	M4	3.2	27
15																
18.5					33	1.9	300-027-138	105	109	51	129	64	90	26		
18.5	47	1.3	300-027-140	2	115	142.5	57.5	136	72	90	25	-	M6	M5	6	42

### AC Reactor (UZBA-B for 50/60 Hz Input)

Base device selection on motor capacity.

Lead Wire Type



#### Connection Diagram

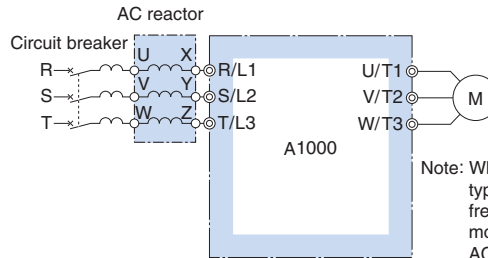

#### Dimensions (mm)

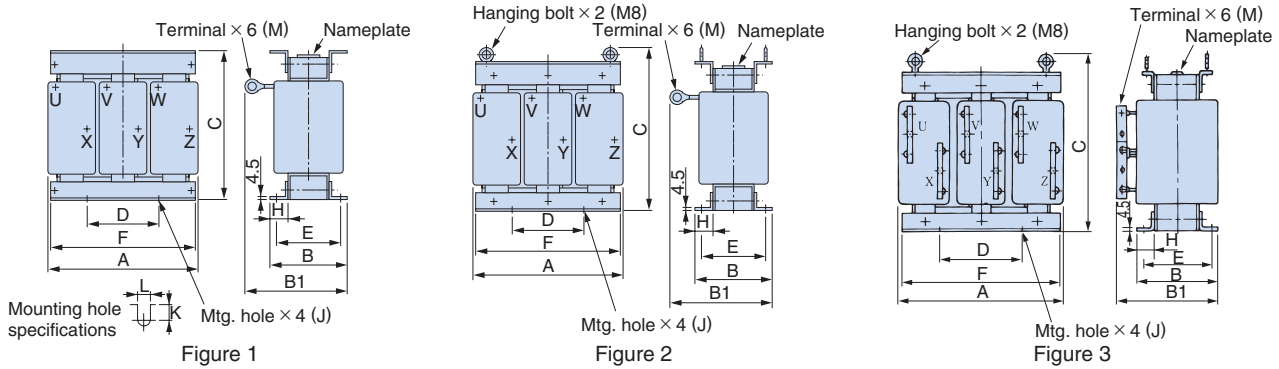

#### 200 V Class

Motor Capacity (kW)	Current (A)	Inductance (mH)	Code No.	Figure	Dimensions (mm)											Weight (kg)	Watt Loss (W)		
					A	B	B1	C	D	E	F	H	J	K	L			M	
3.7	20	0.53	X002491	1	130	88	114	105	50	70	130	22	M6	11.5	7	M5	3	35	
5.5	30	0.35	X002492				119							9			3	45	
7.5	40	0.265	X002493			98	139	11.5	M6	4		50							
11	60	0.18	X002495			105	147.5	10	M6	6		65							
15	80	0.13	X002497		180	100	155	150	75	80	180	25	M6	10	7	M8	8	75	
18.5	90	0.12	X002498				150												80
22	120	0.09	X002555		210	100	155	175	75	80	205	25	M6	10	7	M10	12	100	
30	160	0.07	X002556				170												95
37	200	0.05	X002557		240	115	183	215±5	150	110	240	25	M6	10	7	M10	23	125	
45	240	0.044	X002558				183												8
55	280	0.038	X002559		270	126	218	230±5	150	130	260	40	M8	16	10	M12	32	145	
75	360	0.026	X002560				218												10
90	500	0.02	X010145		2	330	162	286	315±5	150	130	320	40	M10	16	10	M12	55	200
110	500	0.02	X010145																

#### 400 V Class

Motor Capacity (kW)	Current (A)	Inductance (mH)	Code No.	Figure	Dimensions (mm)											Weight (kg)	Watt Loss (W)		
					A	B	B1	C	D	E	F	H	J	K	L			M	
7.5	20	1.06	X002502	1	160	90	130	75	70	160	25	M6	10	7	M5	5	50		
11	30	0.7	X002503			105										85	6	65	
15	40	0.53	X002504		180	100	140	150	75	80	180	25	M6	10	7	M6	8	90	
18.5	50	0.42	X002505				145												150
22	60	0.36	X002506		210	100	150	175	75	80	205	25	M6	10	7	M8	12	95	
30	80	0.26	X002508				150												95
37	90	0.24	X002509		240	115	178	205±5	150	110	240	25	M8	8	10	M10	23	130	
45	120	0.18	X002566				178												10
55	150	0.15	X002567		270	126	193	230±5	150	130	260	40	M8	16	10	M10	32	135	
75	200	0.11	X002568				193												10
90	250	0.09	X002569		270	162	198	230±5	150	130	260	40	M8	16	10	M10	32	135	
110	250	0.09	X002569				198												10
132	330	0.06	X002570		2	330	176	293	315±5	150	150	320	40	M10	13	12	M12	60	340
160	330	0.06	X002570																
185	490	0.04	X002690	3	330	216	353	315±5	150	185	320	40	M10	15.5	18	M16	80	310	
220	490	0.04	X002690																353
250	490	0.04	X002690	2	330	176	293	315±5	150	150	320	40	M10	13	12	M12	60	340	
315	660	0.03	X002691																293
355	660	0.03	X002691	3	330	216	353	315±5	150	185	320	40	M10	15.5	18	M16	80	310	
450	490*1	0.04	X002690 × 2*2																353
500	490*1	0.04	X002690 × 2*2	2	330	176	293	315±5	150	150	320	40	M10	13	12	M12	60	340	
560	660*1	0.03	X002691 × 2*2																293
630	660*1	0.03	X002691 × 2*2	3	330	216	353	315±5	150	185	320	40	M10	15.5	18	M16	80	310	
			X002691 × 2*2																353

\*1: Rated current for a single unit.

\*2: When two units are connected in parallel.



## Terminal Type

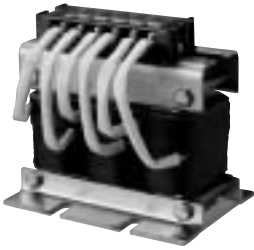

### Dimensions (mm)

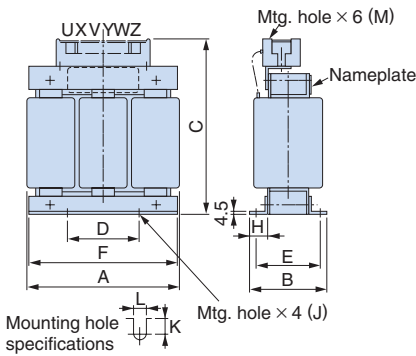

Figure 1

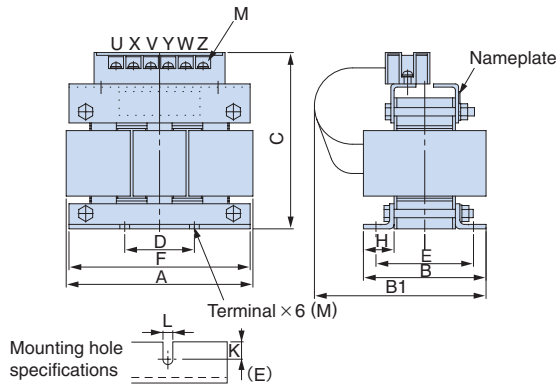

Figure 2

### 200 V Class

Motor Capacity (kW)	Current (A)	Inductance (mH)	Code No.	Figure	Dimensions (mm)											Weight (kg)	Watt Loss (W)				
					A	B	B1	C	D	E	F	H	J	K	L			M			
0.4	2.5	4.2	X002553	1	120	71	-	120	40	50	105	20	M6	10.5	7	M4	2.5	15			
0.75	5	2.1	X002554		130	88	-	130	50	70	130	22		11.5			3	25			
1.5	10	1.1	X002489		2	135	88	140	130	50	70	130		22	-		7	M5	3	30	
2.2	15	0.71	X002490			150	130	50	70	130	22	9		3	35						
3.7	20	0.53	300-027-120	2	135	98	160	140	50	80	130	22	11.5	7	M6	4	50				
5.5	30	0.35	300-027-121		165	105	185	170	75	85	160	25	10			6	65				
7.5	40	0.265	300-027-122		1	185	100	180	195	75	80	180	25			10	M6	8	75		
11	60	0.18	300-027-123			2	185	100	180	195	75	80	180			25		10	M6	8	90
15	80	0.13	300-027-124																		
18.5	90	0.12	300-027-125																		

### 400 V Class

Motor Capacity (kW)	Current (A)	Inductance (mH)	Code No.	Figure	Dimensions (mm)											Weight (kg)	Watt Loss (W)				
					A	B	B1	C	D	E	F	H	J	K	L			M			
0.4	1.3	18	X002561	1	120	71	-	120	40	50	105	20	M6	10.5	7	M4	2.5	15			
0.75	2.5	8.4	X002562		130	88	-	130	50	70	130	22		9			3	25			
1.5	5	4.2	X002563		2	130	88	140	130	50	70	130		22	11.5		7	M5	4	50	
2.2	7.5	3.6	X002564																150	130	50
3.7	10	2.2	X002500	2	165	90	160	155	75	70	160	25	10	7	M4	5	50				
5.5	15	1.42	X002501		105	175	85	160		85	160					6	65				
7.5	20	1.06	300-027-126		1	185	100	170	185	75	80	180				25	10	7	M5	8	90
11	30	0.7	300-027-127																		
15	40	0.53	300-027-128																		
18.5	50	0.42	300-027-129																		

### Zero Phase Reactor

Zero-phase reactor should match wire gauge.\*

\* Current values for wire gauges may vary based on electrical codes.

The table below lists selections based on Japanese electrical standards and Yaskawa's ND rating. Contact Yaskawa for questions regarding UL.

#### Finemet Zero-Phase Reactor to Reduce Radio Noise

Note: Finemet is a registered trademark of Hitachi Metals, Ltd.



[Hitachi Metals, Ltd.]

#### Connection Diagram

Compatible with the input and output side of the drive.

Example: Connection to output terminal

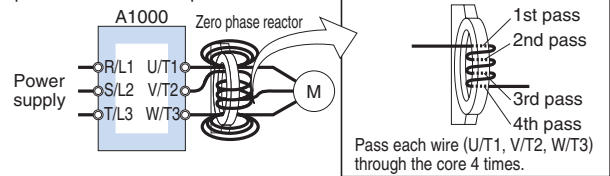
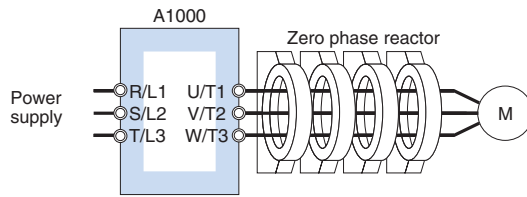
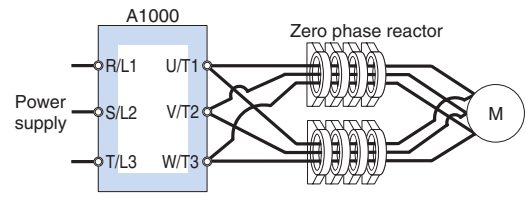

Diagram a



All wires (U/T1, V/T2, W/T3) should pass through the four cores of the reactor in series without winding.

Diagram b



Separate each terminal lead for U/T1, V/T2, and W/T3 in half, passing one half of the wires through a set of four cores and the other half through the other set of four cores as shown.

Diagram c

#### Dimensions (mm)

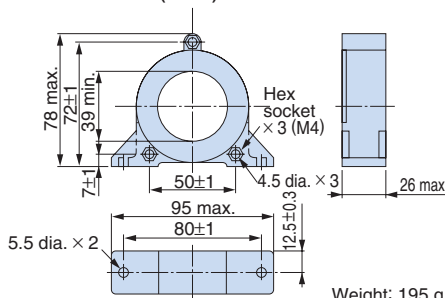

Model F6045GB

Weight: 195 g

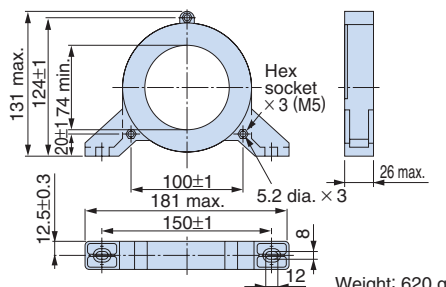

Model F11080GB

Weight: 620 g

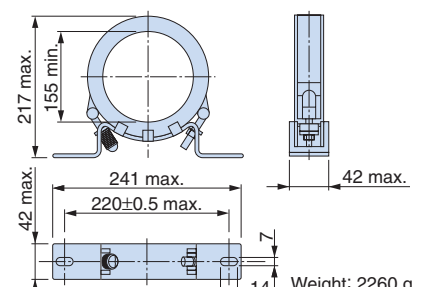

Model F200160PB

Weight: 2260 g

#### 200 V Class

Motor Capacity (kW)	A1000		Zero Phase Reactor										
	Recommended Gauge (mm <sup>2</sup> )		Input Side				Output Side						
	Input Side	Output Side	Model	Code No.	Qty.	Diagram	Model	Code No.	Qty.	Diagram			
0.4													
0.75	2	2	F6045GB	FIL001098	1	a	F6045GB	FIL001098	1	a			
1.5													
2.2													
3.7	3.5	3.5											
5.5	5.5	3.5											
7.5	8	8	F11080GB	FIL001097	1	a	F11080GB	FIL001097	1	a			
11	14	14											
15	22	14											
18.5	30	22	F6045GB	FIL001098			F6045GB	FIL001098					
22	38	30											
30	38	38											
37	60	60											
45	80	80	F11080GB	FIL001097	4	b	F11080GB	FIL001097	4	b			
55	100	80×2P											
75	80×2P	80×2P											
90	80×2P	80×2P	F200160PB	300-001-041			F200160PB	300-001-041					
110	*	*											

\*Model 2A0360: 100 × 2P, model 2A0415: 125 × 2P

#### 400 V Class

Motor Capacity (kW)	A1000		Zero Phase Reactor											
	Recommended Gauge (mm <sup>2</sup> )		Input Side				Output Side							
	Input Side	Output Side	Model	Code No.	Qty.	Diagram	Model	Code No.	Qty.	Diagram				
0.4														
0.75	2	2	F6045GB	FIL001098	1	a	F6045GB	FIL001098	1	a				
1.5														
2.2														
3.7														
5.5														
7.5	5.5	5.5	F6045GB	FIL001098	1	a	F6045GB	FIL001098	1	a				
11														
15														
18.5	14	14	F6045GB	FIL001098	4	b	F6045GB	FIL001098	4	b	F11080GB	FIL001097	1	a
22														
30														
37	22	22												
45	30	30												
55	38	38												
75	60	60												
90	80	80												
110	125	125	F11080GB	FIL001097			F11080GB	FIL001097						
132	150	150												
160	200	200												
185	250	250												
220	100 × 2P	125 × 2P												
250	125 × 2P	150 × 2P												
315	80 × 4P	80 × 4P	F200160PB	300-001-041	4	b	F200160PB	300-001-041	4	b				
355														
450	125 × 4P	125 × 4P												
500	150 × 4P	150 × 4P												
560	100 × 8P	100 × 8P												
630	125 × 8P	125 × 8P									8	c	8	c

## Fuse and Fuse Holder

Install a fuse to the drive input terminals to prevent damage in case a fault occurs.  
Refer to the instruction manual for information on UL-approved components.

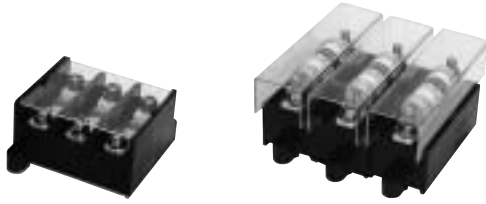

[Fuji Electric FA Components & Systems Co., Ltd]

## Connection Diagram

DC Input Power Supply  
(example shows two A1000 drives connected in parallel)  
For use with an AC power supply see the connection diagram on page 28.

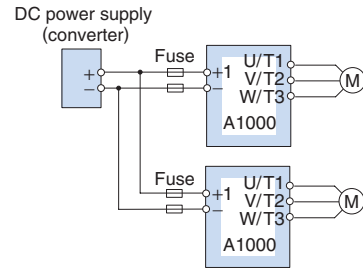

Note: When connecting multiple drives together, make sure that each drive has its own fuse. If any one fuse blows, all fuses should be replaced.

### 200 V Class

Model CIMR-AA2A	AC Power Supply Input				DC Power Supply Input			
	Fuse		Fuse Holder		Fuse		Fuse Holder	
	Model	Qty.	Model	Qty.	Model	Qty.	Model	Qty.
0004	CR2LS-30	3	CM-1A	1	CR2LS-30	2	CM-1A	1
0006								
0008								
0010								
0012								
0018	CR2LS-50				CR2LS-50			
0021	CR2LS-75				CR2LS-75			
0023	CR2LS-100				CR2LS-100			
0040	CR2L-125	3	CM-2A	1	CR2L-125	2	CM-2A	1
0056								
0069								
0081								
0110								
0138								
0169								
0211								
0250								
0312								
0360	CR2L-150				CR2L-150			
0415								
	CR2L-225				CR2L-225			
	CR2L-260				CR2L-260			
	CR2L-300				CR2L-300			
	CR2L-350				CR2L-350			
	CR2L-400		*		CR2L-400		*	
	CR2L-450				CR2L-450			
	CR2L-600				CR2L-600			
	CS5F-800				CS5F-800			
	CS5F-1200				CS5F-1200			

\* Manufacturer does not recommend a specific fuse holder for this fuse.  
Contact the manufacturer for information on fuse dimensions.

### 400 V Class

Model CIMR-AA4A	AC Power Supply Input				DC Power Supply Input											
	Fuse		Fuse Holder		Fuse		Fuse Holder									
	Model	Qty.	Model	Qty.	Model	Qty.	Model	Qty.								
0002	CR6L-20	3	CMS-4	3	CR6L-20	2	CMS-4	2								
0004																
0005																
0007																
0009																
0011	CR6L-30				CR6L-30											
0018	CR6L-50				CR6L-50											
0023	CR6L-75	3	CMS-5	3	CR6L-75	2	CMS-5	2								
0031																
0038																
0044																
0058																
0072																
0088																
0103																
0139																
0165																
0208	CR6L-100	3	*		CR6L-100	2	*									
0250																
0296																
0362																
0414																
0515																
0675																
0930																
1200																
									CR6L-150				CR6L-150			
									CR6L-200				CR6L-200			
									CR6L-250				CR6L-250			
									CR6L-300				CR6L-300			
									CR6L-350				CR6L-350			
									CR6L-400				CR6L-400			
	CS5F-600				CS5F-600											
	CS5F-800				CS5F-800											
	CS5F-1000				CS5F-1000											
	CS5F-1200				CS5F-1200											
	CS5F-1500				CS5F-1500											

## Capacitor-Type Noise Filter

Capacitor-type noise filter exclusively designed for drive input.  
The noise filter can be used in combination with a zero-phase reactor. For both 200 V and 400 V classes.  
Note: The capacitor-type noise filter can be used for drive input only. Do not connect the noise filter to the output terminals.



[Okaya Electric Industries Co., Ltd.]

### Connection Diagram

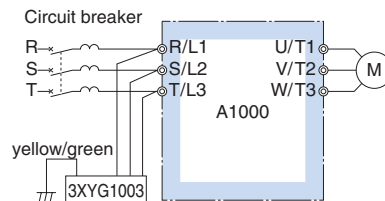

### Dimensions (mm)

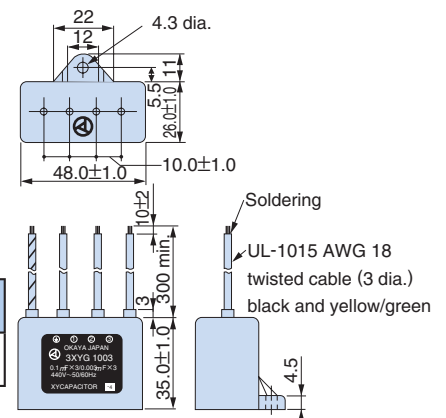

### Specifications

Model	Code No.
3XYG 1003	C002889

Rated Voltage	Capacitance (3 devices each)	Operating Temperature (°C)
440 V	X (Δ connection) : 0.1 μF ± 20 % Y (λ connection) : 0.003 μF ± 20 %	- 40 to +85

Note: For use with 460 V and 480 V units, contact Yaskawa directly.

### Input Noise Filter

Base device selection on motor capacity.

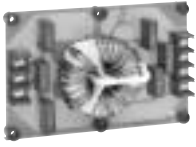

Noise Filter without Case



Noise Filter with Case



#### Connection Diagram

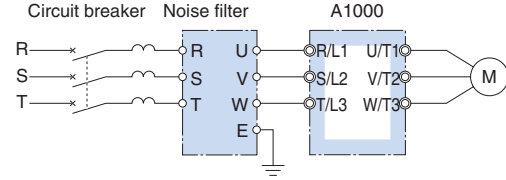

Note: Do not connect the input noise filter to the drive output terminals (U, V, W). Connect in parallel when using two filters.

#### Noise Filter [Schaffner EMC K.K.]

Note: Refer to the instruction manual for information on the CE mark and compliance with the EMC directive.

### 200 V Class

Motor Capacity (kW)	Noise Filter without Case				Noise Filter with Case				Noise Filter by Schaffner EMC K.K.			
	Model	Code No.	Qty.	Rated Current (A)	Model	Code No.	Qty.	Rated Current (A)	Model	Code No.	Qty.	Rated Current (A)
0.4												
0.75	LNFD-2103DY	FIL000132	1	10	LNFD-2103HY	FIL000140	1	10	—	—	—	—
1.5												
2.2	LNFD-2153DY	FIL000133	1	15	LNFD-2153HY	FIL000141	1	15	—	—	—	—
3.7	LNFD-2303DY	FIL000135	1	30	LNFD-2303HY	FIL000143	1	30	—	—	—	—
5.5	LNFD-2203DY	FIL000134	2	40	LNFD-2203HY	FIL000142	2	40	FN258L-42-07	FIL001065	1	42
7.5									FN258L-55-07	FIL001066	1	55
11									FN258L-75-34	FIL001067	1	75
15	LNFD-2303DY	FIL000135	3	90	LNFD-2303HY	FIL000143	3	90	FN258L-100-35	FIL001068	1	100
18.5									FN258L-130-35	FIL001069	1	130
22									FN258L-130-35	FIL001069	1	130
30									FN258L-180-07	FIL001070	1	180
37									FN359P-250-99	FIL001071	1	250
45									FN359P-400-99	FIL001073	1	400
55	—	—	—	—	—	—	—	—	FN359P-500-99	FIL001074	1	500
75									FN359P-600-99	FIL001075	1	600
90												
110												

### 400 V Class

Motor Capacity (kW)	Noise Filter without Case				Noise Filter with Case				Noise Filter by Schaffner EMC K.K.			
	Model	Code No.	Qty.	Rated Current (A)	Model	Code No.	Qty.	Rated Current (A)	Model	Code No.	Qty.	Rated Current (A)
0.4	LNFD-4053DY	FIL000144	1	5	LNFD-4053HY	FIL000149	1	5				
0.75												
1.5	LNFD-4103DY	FIL000145	1	10	LNFD-4103HY	FIL000150	1	10	—	—	—	—
2.2												
3.7	LNFD-4153DY	FIL000146	1	15	LNFD-4153HY	FIL000151	1	15				
5.5	LNFD-4203DY	FIL000147	1	20	LNFD-4203HY	FIL000152	1	20				
7.5	LNFD-4303DY	FIL000148	1	30	LNFD-4303HY	FIL000153	1	30				
11	LNFD-4203DY	FIL000147	2	40	LNFD-4203HY	FIL000152	2	40	FN258L-42-07	FIL001065	1	42
15									FN258L-55-07	FIL001066	1	55
18.5									FN258L-75-34	FIL001067	1	75
22	LNFD-4303DY	FIL000148	3	90	LNFD-4303HY	FIL000153	3	90	FN258L-100-35	FIL001068	1	100
30									FN258L-100-35	FIL001068	1	100
37									FN258L-130-35	FIL001069	1	130
45									FN258L-180-07	FIL001070	1	180
55									FN359P-300-99	FIL001072	1	300
75									FN359P-400-99	FIL001073	1	400
90									FN359P-500-99	FIL001074	1	500
110	—	—	—	—	—	—	—	—	FN359P-600-99	FIL001075	1	600
132									FN359P-900-99	FIL001076	1	900
160												
185												
220												
250	—	—	—	—	—	—	—	—				
315												
355												
450												
500	—	—	—	—	—	—	—	—	FN359P-600-99	FIL001075	2	1200
560												
630									FN359P-900-99	FIL001076	2	1800

### Without Case

### Dimensions (mm)

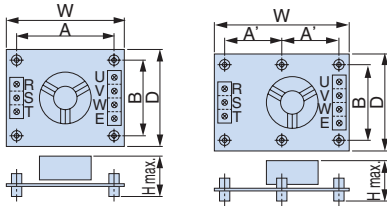
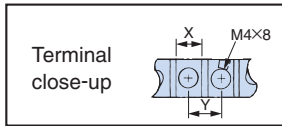

Figure 1

Figure 2



Model LNFD	Code No.	Figure	Dimensions (mm)							Terminal (mm)		Mounting Screw	Weight (kg)
			W	D	H	A	A'	B	M	X	Y		
2103DY	FIL000132	1	120	80	55	108	-	68	20	9	11	M4 × 4,20 mm	0.2
2153DY	FIL000133	1					68						
2203DY	FIL000134	1	170	90	70	158	78	78	20	9	11	M4 × 4,20 mm	0.4
2303DY	FIL000135	2		110		-	79	98		10	13	M4 × 6,20 mm	0.5
4053DY	FIL000144	2			75								0.3
4103DY	FIL000145	2	170	130	95	-	79	118	30	9	11	M4 × 6,30 mm	0.4
4153DY	FIL000146	2											
4203DY	FIL000147	2								9	11	M4 × 4,30 mm	0.5
4303DY	FIL000148	2	200	145	100	-	94	133	30	10	13		0.6

### With Case

### Dimensions (mm)

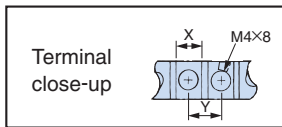
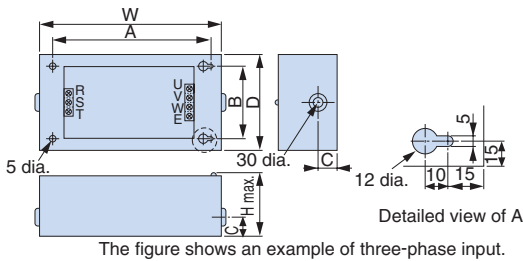

Model LNFD	Code No.	Dimensions (mm)						Terminal (mm)		Weight (kg)
		W	D	H	A	B	C	X	Y	
2103HY	FIL000140	185	95	85	155	65	33	9	11	0.9
2153HY	FIL000141									
2203HY	FIL000142	240	125	100	210	95	33	9	11	1.5
2303HY	FIL000143							10	13	1.6
4053HY	FIL000149									1.6
4103HY	FIL000150	235	140	120	205	110	43	9	11	1.7
4153HY	FIL000151									
4203HY	FIL000152							9	11	2.2
4303HY	FIL000153	270	155	125	240	125	43	10	13	

### Manufactured by Schaffner EMC K.K.

### Dimensions (mm)

### Connecting Noise Filters in Parallel to the Input or Output Side (examples shows two filters in parallel)

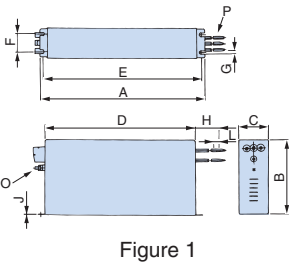

Figure 1

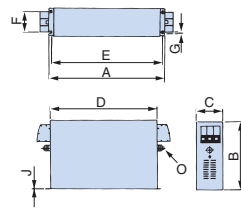
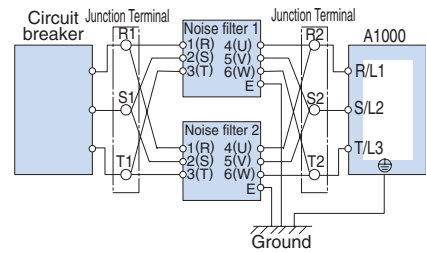

Figure 2



A junction terminal block should be included in the circuit when connecting noise filters in parallel in order to keep the current level balanced. Noise filters and grounding wire should be as heavy and as short as possible.

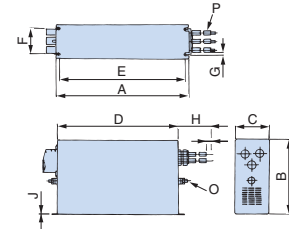

Figure 3

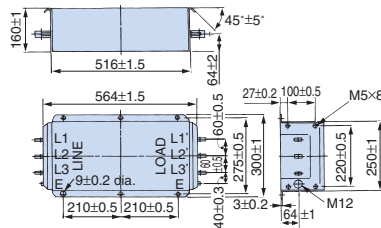

Figure 4

Model	Weight (kg)
FN359P-250-99	16
FN359P-300-99	16
FN359P-400-99	18.5
FN359P-500-99	19.5
FN359P-600-99	20.5
FN359P-900-99	33

Model	Figure	Dimensions (mm)											Wire Gauge P	Weight (kg)
		A	B	C	D	E	F	G	H	J	L	O		
FN258L-42-07	1	329	185 ± 1	70	300	314	45	6.5	500	1.5	12	M6	AWG8	2.8
FN258L-55-07			80	55			3.1							
FN258L-75-34			220	-			-						4	
FN258L-100-35	2	379 ± 1.5	220	90 ± 0.8	350 ± 1.2	364	65	6.5	-	1.5	-	M10	-	5.5
FN258L-130-35	2	439 ± 1.5	240	110 ± 0.8	400 ± 1.2	414	80			3			7.5	
FN-258L-180-07	3	438 ± 1.5				413			500	4	15		50 mm <sup>2</sup>	11
FN359P- LNFD	4	Described in Figure 4												Shown in the above table.

Note: For CE Marking (EMC Directive) compliant models, contact us for inquiry.

### Output Noise Filter

Base device selection on motor capacity.



[NEC Tokin Corporation]

Connection Diagram

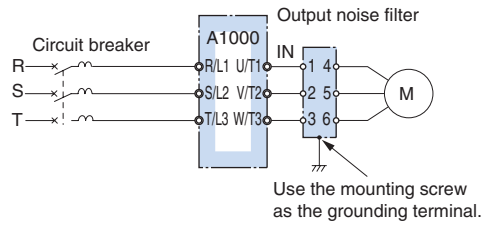

Dimensions (mm)

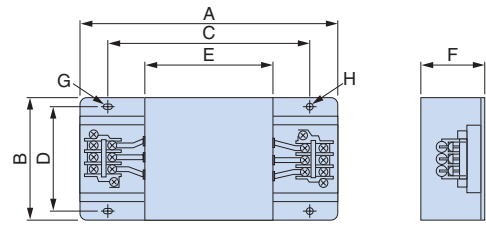

### 200 V Class

Motor Capacity (kW)	Model	Code No.	Qty.*1	Rated Current (A)	Dimensions (mm)								Terminal	Weight*2 (kg)
					A	B	C	D	E	F	G	H		
0.4	LF-310KA	FIL000068	1	10	140	100	100	90	70	45	7×φ4.5	φ4.5	TE-K5.5 M4	0.5
0.75														
1.5														
2.2	LF-320KA	FIL000069	1	20	140	100	100	90	70	45	7×φ4.5	φ4.5	TE-K5.5 M4	0.6
3.7														
5.5														
7.5	LF-350KA	FIL000070	1	50	260	180	180	160	120	65	7×φ4.5	φ4.5	TE-K22 M6	2.0
11														
15														
18.5														
22	LF-350KA*3	FIL000070	3	150	260	180	180	160	120	65	7×φ4.5	φ4.5	TE-K22 M6	2.0
	LF-3110KB*3	FIL000076	1	110	540	340	480	300	340	240	9×φ6.5	φ6.5	TE-K60 M8	19.5
30	LF-350KA*3	FIL000070	3	150	260	180	180	160	120	65	7×φ4.5	φ4.5	TE-K22 M6	2.0
	LF-375KB*3	FIL000075	2	150	540	320	480	300	340	240	9×φ6.5	φ6.5	TE-K22 M6	12.0
37	LF-3110KB	FIL000076	2	220	540	340	480	300	340	240	9×φ6.5	φ6.5	TE-K60 M8	19.5
45														
55														
75														
90	LF-3110KB	FIL000076	3	330	540	340	480	300	340	240	9×φ6.5	φ6.5	TE-K60 M8	19.5
			4	440										
			5	550										
110														

\*1: Connect in parallel when using more than one filter.

\*2: Weight of one filter.

\*3: Either noise filter model can be used.

### 400 V Class

Motor Capacity (kW)	Model	Code No.	Qty.*1	Rated Current (A)	Dimensions (mm)								Terminal	Weight*2 (kg)
					A	B	C	D	E	F	G	H		
0.4	LF-310KB	FIL000071	1	10	140	100	100	90	70	45	7×φ4.5	φ4.5	TE-K5.5 M4	0.5
0.75														
1.5														
2.2														
3.7	LF-320KB	FIL000072	1	20	140	100	100	90	70	45	7×φ4.5	φ4.5	TE-K5.5 M4	0.6
5.5														
7.5														
11	LF-335KB	FIL000073	1	35	140	100	100	90	70	45	7×φ4.5	φ4.5	TE-K5.5 M4	0.8
15														
18.5	LF-345KB	FIL000074	1	45	260	180	180	160	120	65	7×φ4.5	φ4.5	TE-K22 M6	2.0
22	LF-375KB	FIL000075	1	75	540	320	480	300	340	240	9×φ6.5	φ6.5	TE-K22 M6	12.0
30	LF-3110KB	FIL000076	1	110	540	340	480	300	340	240	9×φ6.5	φ6.5	TE-K60 M8	19.5
37														
45														
55														
75	LF-3110KB	FIL000076	2	220	540	340	480	300	340	240	9×φ6.5	φ6.5	TE-K60 M8	19.5
90														
110														
132														
160														
185														
220														
250														
315														
355														
450														
500														
560														
630														

\*1: Connect in parallel when using more than one filter.

\*2: Weight of one filter.

## 24 V Power Supply

The 24 V Power Supply Option maintains drive control circuit power in the event of a main power outage. The control circuit keeps the network communications and I/O data operational in the event of a power outage. It supplies external power to the control circuit only.

Note: Even if a back-up power supply is used for the control circuit, the main circuit must still have power in order to change parameter settings.

The installed option adds 50 mm to the total depth of the drive.  
Installed internally for models 185 kW (CIMR-AA4A0414) and above.

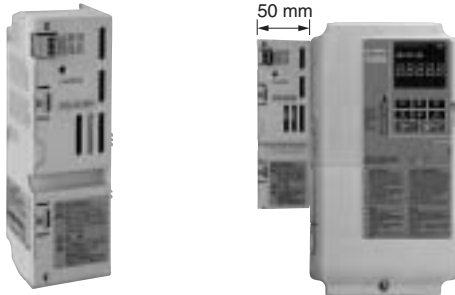

Weight: 0.2 kg

Model	Code No.
200 V Class: PS-A10L	PS-A10L
400 V Class: PS-A10H	PS-A10H

### Connection Diagram

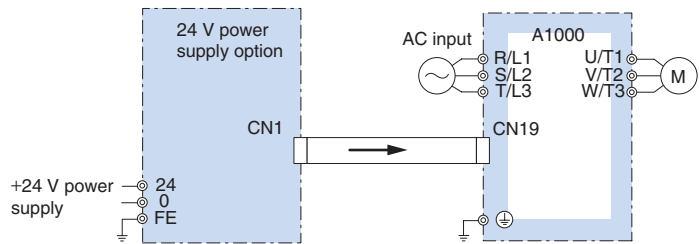

## Momentary Power Loss Recovery Unit

### Connection Diagram



Weight: 2 kg

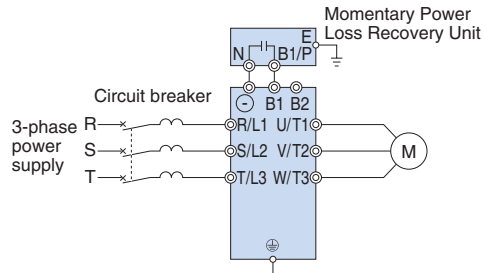

### Dimensions (mm)

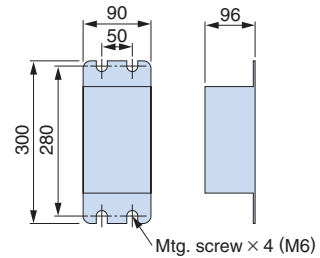

Model	Code No.
200 V Class: P0010	P0010
400 V Class: P0020	P0020

Note: Functions as a back-up power supply for drives up to 11 kW. Allows the drive to ride through a power loss up to 2 s long. The drive alone can continue running through a power loss lasting 0.1 s to 1.0 s. Results may vary with drive capacity.

### Braking Unit, Braking Resistor, Braking Resistor Unit

Braking units come standard with 200 V and 400 V class drives 0.4 to 30 kW. If the application requires a braking resistor or braking unit, choose from built-in and stand-alone types in accordance with motor capacity.



Stand-alone

Braking Unit  
[CDBR series]



Built-in

Braking Resistor  
[ERF-150WJ series]



Built-in

Braking Resistor with Fuse  
[CF120-B579 series]



Stand-alone

Braking Resistor Unit  
[LKEB series]



Stand-alone

### 200 V Class

Max. Applicable Motor (kW)	ND/HD	A1000 Model CIMR-AA2A	Braking Unit		Braking Resistor (Duty Factor: 3% ED, 10 s max.)*1								Braking Resistor Unit (Duty Factor: 10% ED, 10 s max.)*1				Min.*2 Connectable Resistance (Ω)			
			Model CDBR-	Qty.	No Fuse				With Fuse				Model LKEB-	Resistor Specifications (per unit)	Qty.	Diagram		Braking Torque (%)		
					Model ERF-150WJ	Resistance (Ω)	Qty.	Diagram	Braking Torque (%)	Model CF120-B579	Resistance (Ω)	Qty.							Diagram	Braking Torque (%)
0.4	HD	0004			201	200	1	A	220	B	200	1	A	220	20P7	70 W 200 Ω	1	B	220	48
0.75	ND	0004			201	200	1	A	125	B	200	1	A	125	20P7	70 W 200 Ω	1	B	125	48
	HD	0006																		
1.1	ND	0006			201	200	1	A	85	B	200	1	A	85	20P7	70 W 200 Ω	1	B	85	48
	HD	0008			101	100			150	C	100			1	150				21P5	
1.5	ND	0008			101	100	1	A	125	C	100	1	A	125	21P5	260 W 100 Ω	1	B	125	48
	HD	0010																		
2.2	ND	0010			700	70	1	A	120	D	70	1	A	120	22P2	260 W 70 Ω	1	B	120	48
	HD	0012																		16
3	ND	0012			620	62	1	A	100	E	62	1	A	100	22P2	390 W 40 Ω	1	B	150	16
	HD	0018																		
3.7	ND	0018			620	62	1	A	80	E	62	1	A	80	23P7	390 W 40 Ω	1	B	125	16
	HD	0021																		
5.5	ND	0021			620	62	2	A	110	E	62	2	A	110	25P5	520 W 30 Ω	1	B	115	16
	HD	0030																		
7.5	ND	0030													27P5	780 W 20 Ω	1	B	125	16
	HD	0040																		9.6
11	ND	0040													2011	2400 W 13.6 Ω	1	B	125	9.6
	HD	0056																		
15	ND	0056													2015	3000 W 10 Ω	1	B	125	9.6
	HD	0069																		
18.5	ND	0069													2015	3000 W 10 Ω	1	B	100	9.6
	HD	0081																		
22	ND	0081													2015	3000 W 10 Ω	1	B	85	9.6
	HD	0110													2022	4800W 6.8 Ω			125	6.4
30	ND	0110													2022	4800 W 6.8 Ω	1	B	90	6.4
	HD	0138																		
37	ND	0138													2022	4800 W 6.8 Ω	1	B	70	6.4
	HD	0169	2015B	2											2015	3000 W 10 Ω	2	D	100	9.6
45	ND	0169	2015B	2											2015	3000 W 10 Ω	2	D	80	9.6
	HD	0211	2022B	2											2022	4800 W 6.8 Ω			120	6.4
55	ND	0211													2022	4800 W 6.8 Ω	2	D	100	6.4
	HD	0250	2022B	2																
75	ND	0250	2110B	1											2022	4800 W 6.8 Ω	3	E	110	1.6
	HD	0312																		
90	ND	0312	2110B	1											2022	4800 W 6.8 Ω	4	E	120	1.6
	HD	0360																		
110	ND	0360	2110B	1																
	HD	0415													2018	4800 W 8 Ω	5	E	100	1.6
	HD	0415																		

\*1 : Refers to a motor coasting to stop with a constant torque load. Constant output and regenerative braking will reduce the duty factor.

\*2 : Assumes the use of a single braking unit. The braking unit should have a resistance higher than the minimum connectable resistance value and be able to generate enough braking torque to stop the motor.

\*3 : Applications with a relatively large amount of regenerative power (elevators, hoists, etc.) may require more braking power than is possible with only the standard braking unit and braking resistor. Contact Yaskawa for information if braking torque exceeds the value shown.

Note: 1. Braking resistor (ERF-150WJ and CF120-B579) requires a separate attachment for installation. See attachment for braking resistor unit on page 51.

2. See the connection diagram on page 50.



400 V Class

Max. Applicable Motor (kW)	ND/HD	A1000 Model CIMR-AA4A	Braking Unit		Braking Resistor (Duty Factor: 3% ED, 10 s max.)*1									Braking Resistor Unit (Duty Factor: 10% ED, 10 s max.)*1					Min.*2 Connectable Resistance (Ω)		
			Model CDBR-	Qty.	No Fuse				With Fuse					Model LKEB-	Resistor Specifications (per unit)		Qty.	Diagram		Braking Torque*3 (%)	
					Model ERF-150WJ	Resistance (Ω)	Qty.	Diagram	Braking Torque*3 (%)	Model CF120-B579	Resistance (Ω)	Qty.	Diagram		Braking Torque (%)	W					Ω
0.4	HD	0002			751	750	1	A	230	F	750	1	A	230	40P7	70 W	750 Ω	1	B	230	96
0.75	ND	0002			751	750	1	A	130	F	750	1	A	130	40P7	70 W	750 Ω	1	B	130	96
	HD	0004																			
1.5	ND	0004			401	400	1	A	125	G	400	1	A	125	41P5	260 W	400 Ω	1	B	125	96
	HD	0005																			64
2.2	ND	0005			301	300	1	A	115	H	300	1	A	115	42P2	260 W	250 Ω	1	B	135	64
	HD	0007																			
3	ND	0007			201	200	1	A	125	J	250	1	A	100	42P2	260 W	250 Ω	1	B	100	64
	HD	0009												43P7	390 W	150 Ω	150			32	
3.7	ND	0009			201	200	1	A	105	J	250	1	A	83	43P7	390W	150 Ω	1	B	135	32
	HD	0011																			
5.5	ND	0011			201	200	2	A	135	J	250	2	A	105	45P5	520 W	100 Ω	1	B	135	32
	HD	0018																			
7.5	ND	0018												47P5	780 W	75 Ω	1	B	130	32	
	HD	0023																			
11	ND	0023												4011	1040 W	50 Ω	1	B	135	32	
	HD	0031																			20
15	ND	0031												4015	1560 W	40 Ω	1	B	125	20	
	HD	0038																			
18.5	ND	0038												4018	4800 W	32 Ω	1	B	125	20	
	HD	0044																			19.2
22	ND	0044												4022	4800 W	27.2 Ω	1	B	125	19.2	
	HD	0058																			
30	ND	0058												4030	6000 W	20 Ω	1	B	125	19.2	
	HD	0072																			
37	ND	0072												4030	6000 W	20 Ω	1	B	100	19.2	
	HD	0088	4045B	1										4037	9600 W	16 Ω		C	125	12.8	
45	ND	0088												4045	9600 W	13.6 Ω	1	C	125	12.8	
	HD	0103	4045B	1																	
55	ND	0103	4045B	1										4045	9600 W	13.6 Ω	1	C	100	12.8	
	HD	0139	4030B	2										4030	6000 W	20 Ω	2	D	135	19.2	
75	ND	0139	4030B	2										4030	6000 W	20 Ω	2	D	100	19.2	
	HD	0165	4045B		4045	9600W	13.6 Ω	145	12.8												
90	ND	0165	4045B	2										4045	9600W	13.6 Ω	2	D	120	12.8	
	HD	0208																			
110	ND	0208												4030	6000 W	20 Ω	3	E	100	3.2	
	HD	0250	4220B	1																	
132	ND	0250												4045	9600W	13.6 Ω	4	E	150	3.2	
	HD	0296	4220B	1																	
160	ND	0296												4045	9600W	13.6 Ω	4	E	140	3.2	
	HD	0362	4220B	1																	
185	ND	0362												4045	9600W	13.6 Ω	4	E	120	3.2	
	HD	0414	4220B	1																	
220	ND	0414												4037	9600 W	16 Ω	5	E	110	3.2	
	HD	0515	4220B	1																	
250	ND	0515	4220B	1										4037	9600 W	16 Ω	5	E	90	3.2	
315	HD	0675	4220B	2										4045	9600 W	13.6 Ω	6	F	110	3.2	
355	ND	0675	4220B	2										4045	9600 W	13.6 Ω	8	F	120	3.2	
450	HD	0930	4220B	2										4037	9600 W	16 Ω	10	F	100	3.2	
500	ND	0930	4220B	2										4037	9600 W	16 Ω	10	F	90	3.2	
560	HD	1200	4220B	3										4037	9600 W	16 Ω	15	F	120	3.2	
630	ND	1200	4220B	3										4037	9600 W	16 Ω	15	F	100	3.2	

\*1 : Refers to a motor coasting to stop with a constant torque load. Constant output and regenerative braking will reduce the duty factor.  
 \*2 : Assumes the use of a single braking unit. The braking unit should have a resistance higher than the minimum connectable resistance value and be able to generate enough braking torque to stop the motor.  
 \*3 : Applications with a relatively large amount of regenerative power (elevators, hoists, etc.) may require more braking power than is possible with only the standard braking unit and braking resistor. Contact Yaskawa for information if braking torque exceeds the value shown.  
 Note: 1. Braking resistor (ERF-150WJ and CF120-B579) requires a separate attachment for installation. See attachment for braking resistor unit on page 51.  
 2. See the connection diagram on page 50.

### Connection Diagram

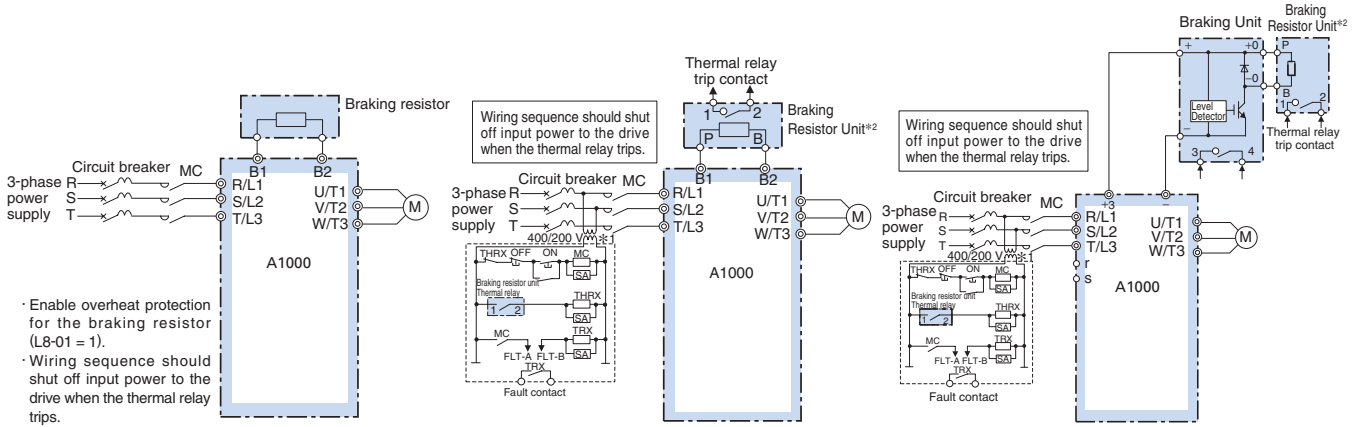

Connection Diagram A

Connection Diagram B

Connection Diagram C

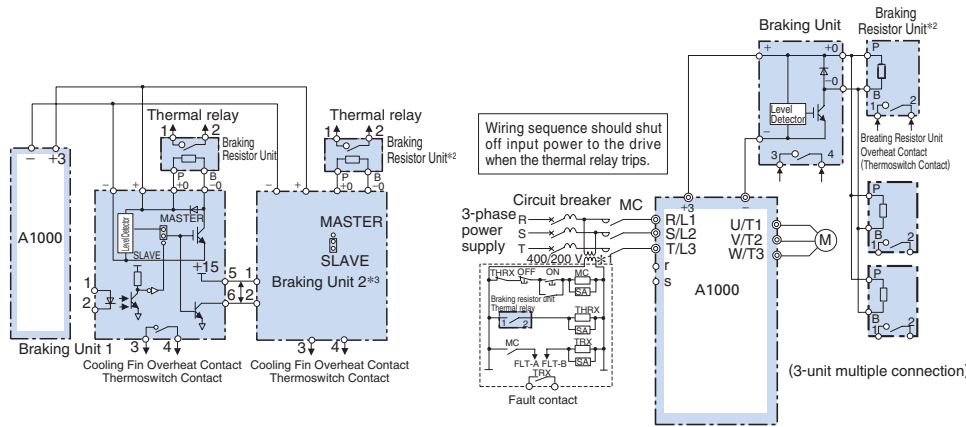

Connection Diagram D

Connection Diagram E

- \*1: 200 V class drives do not require a control circuit transformer.
  - \*2: Disable Stall Prevention during deceleration by setting L3-04 to 0 or 3 when using a Braking Resistor Unit. The motor may not stop within the deceleration time if this setting is not changed.
  - \*3: When using more than one braking unit connected in parallel, set one of the braking units to be the master, and the others to be slaves.
- Note: When connecting a separately-installed type braking resistor unit (model CDBR) to drives with a built-in braking transistor (200 V/400 V 30 kW or less), connect the B1 terminal of the drive to the positive terminal of the braking resistor unit and connect the negative terminal of the drive to the negative terminal of the braking resistor unit. The B2 terminal is not used in this case.

### Dimensions (mm) Braking Unit

Model: CDBR-2015B, -2022B, -4030B, -4045B

Model: CDBR-2110B

Model: CDBR-4220B

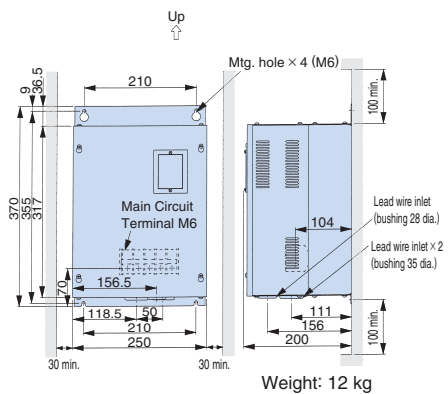
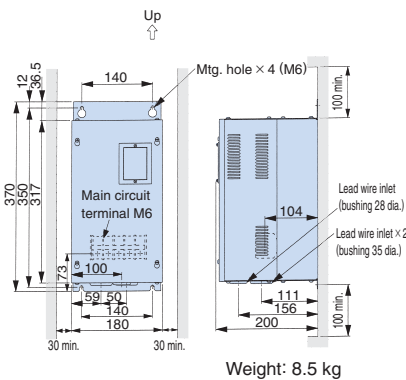
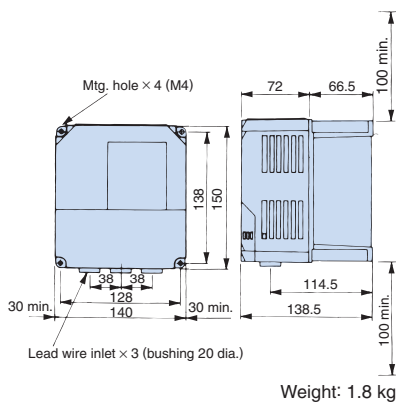

Model	Heat Loss (W)
2015B	32
2022B	38
2110B	64
4030B	54
4045B	59
4220B	71

## Braking Resistor

A separate attachment is needed. Contact Yaskawa for details.  
The following attachment can be used to install to the drive.

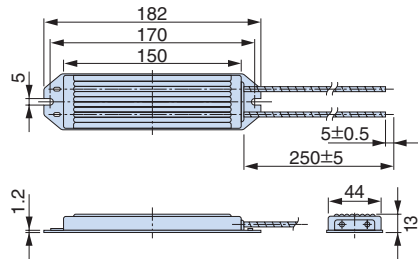

ERF-150WJ series

Weight: 0.2 kg  
(All ERF-150WJ series models)

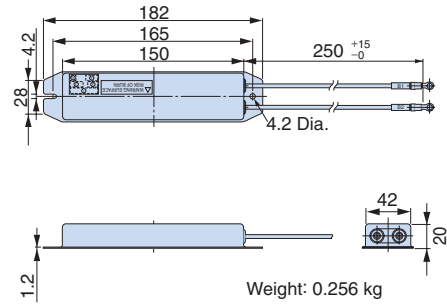

CF120-B579 series

Weight: 0.256 kg  
(All CF120-B579 series models)

## Braking Resistor Unit (stand-alone)

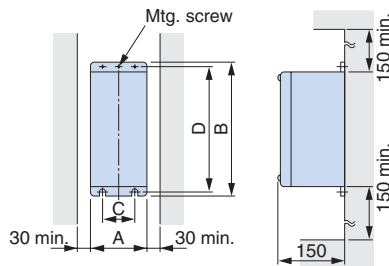

Figure 1

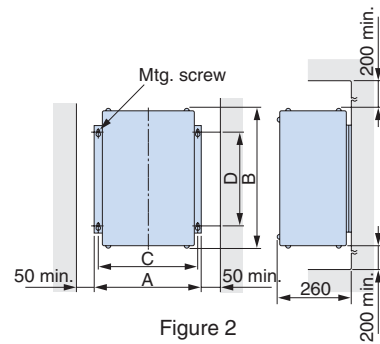
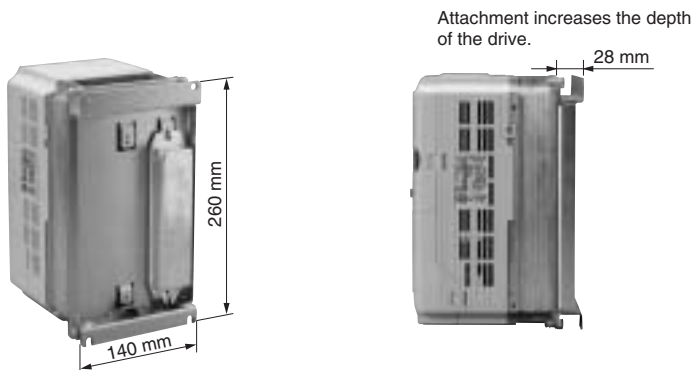

Figure 2

Applicable Voltage Class	Braking Resistor Unit Model LKEB-□□□□□□	Figure	Dimensions (mm)					Weight (kg)	Allowable Average Power Consumption (W)
			A	B	C	D	MTG Screw		
200 V Class	20P7	1	105	275	50	260	M5×3	3.0	30
	21P5	1	130	350	75	335	M5×4	4.5	60
	22P2							4.5	89
	23P7							5.0	150
	25P5	1	250	350	200	335	M6×4	7.5	220
	27P5							8.5	300
	2011	2	446	543	426	340	M8×4	10	440
	2015							15	600
	2018							19	740
2022	19							880	











Applicable Voltage Class	Braking Resistor Unit Model LKEB-□□□□□□	Figure	Dimensions (mm)					Weight (kg)	Allowable Average Power Consumption (W)
			A	B	C	D	MTG Screw		
400 V Class	40P7	1	105	275	50	260	M5×3	3.0	30
	41P5	1	130	350	75	335	M5×4	4.5	60
	42P2							4.5	89
	43P7							5.0	150
	45P5	1	250	350	200	335	M6×4	7.5	220
	47P5							8.5	300
	4011	2	446	543	426	340	M8×4	16	440
	4015							18	600
	4018							19	740
	4022	2	446	543	426	340	M8×4	19	880
	4030							25	1200
	4037							33	1500
	4045							33	1800

## Attachment for Braking Resistor







Model	Code No.
EZZ020805A	100-048-123

### ● VS System Module (Power Supply Capacity 6 VA or less)

Name (Model)	Exterior	Function
Soft Starter A (JGSM-01) Soft Starter B (JGSM-02)		Provides smooth changes in speed during start, stop, and when sudden changes in the speed reference would otherwise impact the load. Independent accel/decel settings, an output signal during speed changes, and fast stopping features are included. Capable of detecting zero speed and motor direction. Acceleration and deceleration time setting ranges: Soft Starter A: 1.5 to 30 s Soft Starter B: 5 to 90 s
Ratio Setter A (JGSM-03)		Converts the current signal 4 to 20 mA of master setter JVOP-03*1 to a voltage signal. Sets five types of ratios and biases.
Ratio Setter B (JGSM-04)		Converts the frequency signal 0 to 2 kHz of master setter JVOP-04*1 to a voltage signal. Sets five types of ratios and biases.
Ratio Setter C (JGSM-17)		Converts a 200 Vac signal, a 30 Vac tachgenerator signal, or a 10 Vdc signal to DC for use as the speed reference. Allows the user to set up to five ratios and biases.
Follower Ratio Setter (JGSM-05)		Converts a frequency signal from a tachgenerator for voltage input. Allows the user to set up to five ratios and biases.
Position Controller (JGSM-06)		Converts a self-synchronizing signal from YVGC-500W*1, then converts that signal to DC voltage proportional to the rotational angle. Equipped with a signal mixing function to minimize deviation from the reference signal.
PID Controller (JGSM-07)		Independently sets ratio gain, integral, and differential time for the simple process control. Integral reset, stepless operation, and wind-up functions are available.
Preamplifier (JGSM-09-□□)*2		Amplifies both the power of DC input signal and output of snap-in function modules JZSP-11 to 16*1.
UP/DOWN Setter (JGSM-10B)		Executes "UP" or "DOWN" command from remote control type VS operator model JVOP-10*1 by lowering or raising reference voltage.
Operational Amplifier (JGSM-12-□□)*3		Required operational circuits are provided through a range of operational impedances.
Signal Selector A (JGSM-13)		Consists of power supply circuit and two relay circuits. Used as a selector circuit of control signals.



Name (Model)	Appearance	Function
Signal Selector B (JGSM-14)		Contains three relay circuits to switch between control signals. Must be using in combination with JGSM-13, which supplies power.
Comparator (JGSM-15-□□)*2		Detects signal levels for DC voltage, current, AC tachogenerator, or frequency reference and compares them with two preset levels. The snap-in module*1 is used to drive relays and output contact signals.
V/I Converter (JGSM-16-□□)*2		Converts DC voltage into a 4 to 20 mA current signal for use with other monitoring devices. A snap-in module*1 can also be added to monitor frequency or provide feedback for a tachogenerator.
D/A Converter (JGSM-18) (JGSM-19)		Converts BCD 3-digit or 12-bit binary digital signals to analog signals of -10 to +10 V with high accuracy. Model JGSM-18: For BCD 3-digit input signals Model JGSM-19: For 12-bit binary signals
Static Potentiometer (JGSM-21 D/A Converter) (JGSM-22 Controller)		Static potentiometer can be used in combination with remote setting device JGSM-10B for the following applications: <ul style="list-style-type: none"> <li>· Maintain reference values despite power loss</li> <li>· Set deceleration times externally</li> <li>· Operate as a soft-starter for an analog signal</li> </ul> JGSM-21 and JGSM-22 must be used in combination with one another.

\*1: Offered as a standard Yaskawa product.

\*2: □□ shows model number of VS snap-in function modules. Refer to the VS Snap-in Module list for more information.

\*3: □□ indicates impedance class.

Note: Both 200 V/220 V at 50 Hz/60 Hz are available as standard models. Use a transformer for other power supplies with a capacity of 6 VA or less.

### VS System Module Dimensions (mm)

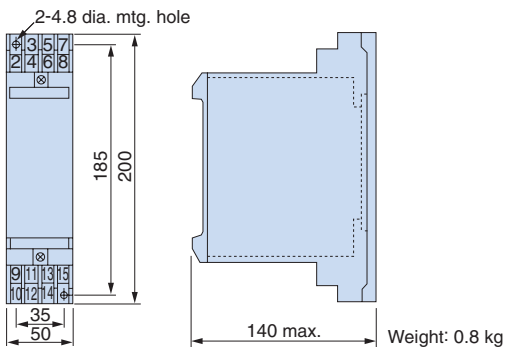

### VS Snap-in Module List

Application	Name	Model
Short-circuit of mounting connector of VS snap-in module	Short-circuit PC board	JZSP-00
Buffer accel/decel operation	Soft starter	JZSP-12
Operation with a process controller or VS operator JVOP-03	I/V converter	JZSP-13
Control using digital operator JVOP-04	f/V converter	JZSP-14
Sequence operation with main unit	Tachogenerator follower	JZSP-15
Amplify or reduce signal	Signal mixer	JZSP-16□□
		JZSP-16-01
		JZSP-16-02
		JZSP-16-03

### LCD Operator

For easier operation when using the optional LCD operator. Includes a copy function for saving drive settings.

Model	Code No.
JVOP-180	100-041-022

Dimensions (mm)

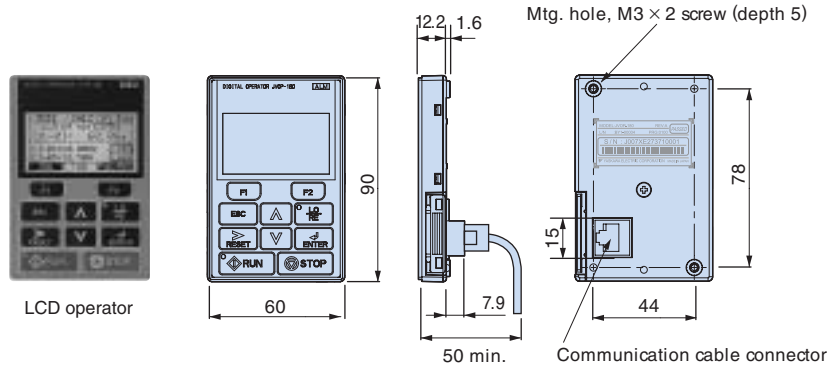

### Operator Extension Cable

Enables remote operation

Model	Code No.
WV001 (1 m)	WV001
WV003 (3 m)	WV003

Note: Never use this cable for connecting the drive to a PC. Doing so may damage the PC.

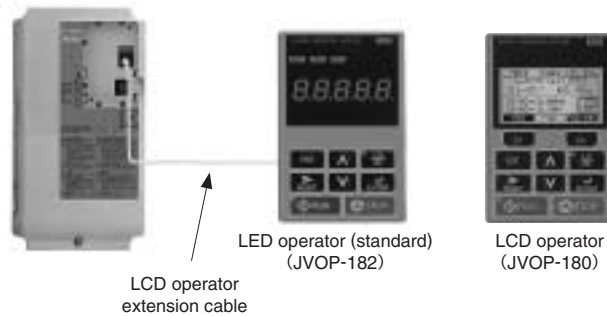

### Operator Mounting Bracket

This bracket is required to mount the LED or LCD operator outside an enclosure panel.

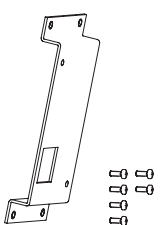
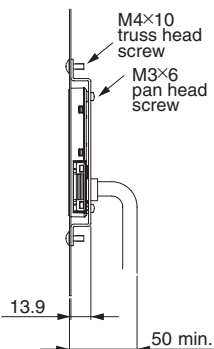
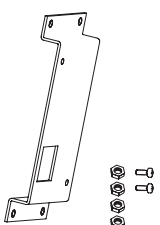
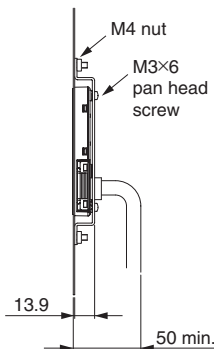
Item	Model	Code No.	Installation	Notes
 Installation Support Set A	EZZ020642A	100-039-992	 M4×10 truss head screw M3×6 pan head screw 13.9 50 min.	For use with holes through the panel
 Installation Support Set B	EZZ020642B	100-039-993	 M4 nut M3×6 pan head screw 13.9 50 min.	For use with panel mounted threaded studs  Note: If weld studs are on the back of the panel, use the Installation Support Set B.



## ● USB Copy Unit (Model: JVOP-181)

Copy parameter settings in a single step, then transfer those settings to another drive. Connects to the RJ-45 port on the drive and to the USB port of a PC.

### Connection

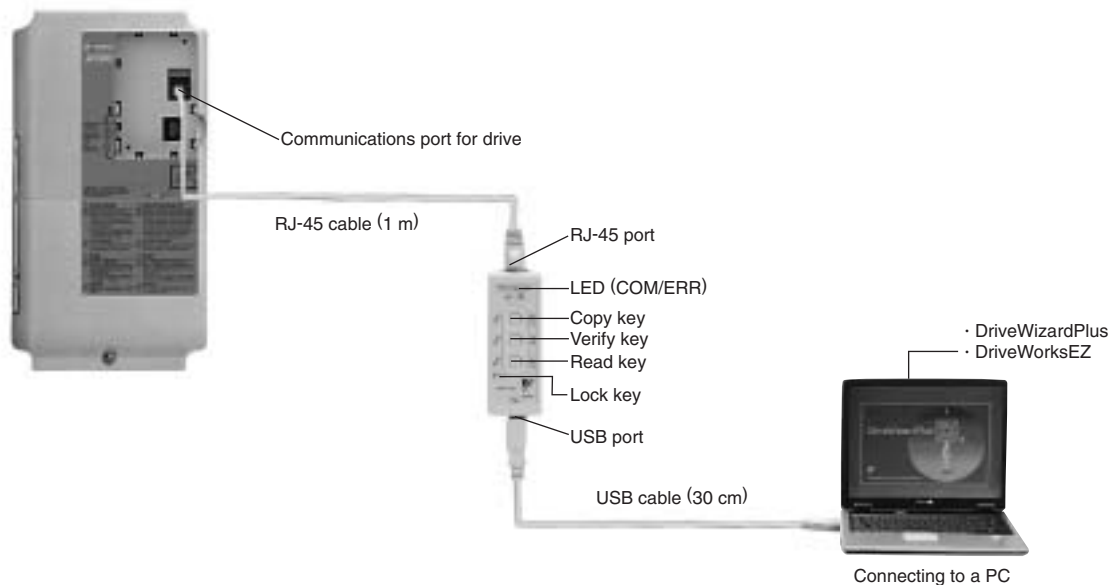

Note: No USB cable is needed to copy parameters to other drives.

Model	Code No.
JVOP-181	100-038-281

Note: JVOP-181 is a set consisting of a USB copy unit, RJ-45 cable, and USB cable.

### Specifications

Item	Specifications
Port	LAN (RJ-45)
	USB (Ver.2.0 compatible)
Power Supply	Supplied from a PC or the drive
Operating System	Windows2000/XP
Memory	Memorizes the parameters for one drive.
Dimensions	30 (W) × 80 (H) × 20 (D) mm
Accessories	RJ-45 Cable(1 m), USB Cable(30 cm)

Note: 1. Drives must have identical software versions to copy parameters settings.  
 2. Requires a USB driver.  
 3. Parameter copy function disabled when connected to a PC.

### Frequency Meter/Current Meter



Model	Code No.
Scale-75 Hz full-scale: DCF-6A	FM000065
Scale-60/120 Hz full-scale: DCF-6A	FM000085
Scale-5 A full-scale: DCF-6A	DCF-6A-5A
Scale-10 A full-scale: DCF-6A	DCF-6A-10A
Scale-20 A full-scale: DCF-6A	DCF-6A-20A
Scale-30 A full-scale: DCF-6A	DCF-6A-30A
Scale-50 A full-scale: DCF-6A	DCF-6A-50A

Note: DCF-6A specifications are 3 V, 1 mA, and 3 k $\Omega$  inner impedance. Because the A1000 multi-function analog monitor output default setting is 0 to 10 V, set frequency meter adjusting potentiometer (20 k $\Omega$ ) or parameter H4-02 (analog monitor output gain) within the range of 0 to 3 V.

#### Dimensions (mm)

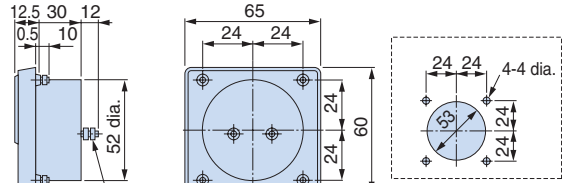

Terminal screw  $\times$  2 (M4)  
Mtg. bolt  $\times$  4 (M3)

Panel Cut-Out

Weight: 0.3 kg

### Variable Resistor Board (installed to drive terminals)



Model	Code No.
Meter scale 20 k $\Omega$	ETX003120

#### Connection Diagram

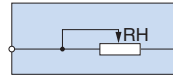

Weight: 20 g

### Frequency Setting Potentiometer/Frequency Meter Adjusting Potentiometer

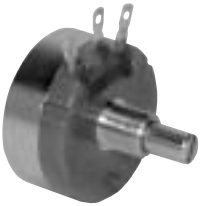

Model	Code No.
RV30YN20S 2 k $\Omega$	RH000739
RV30YN20S 20 k $\Omega$	RH000850

#### Dimensions (mm)

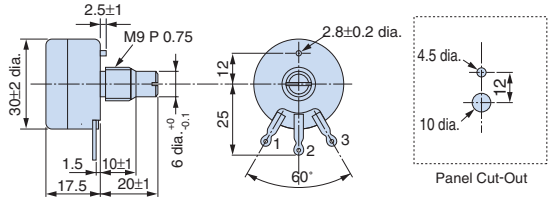

Weight: 0.2 kg

### Control Dial for Frequency Setting Potentiometer/Frequency Meter Adjusting Potentiometer



Model	Code No.
CM-3S	HLNZ-0036

#### Dimensions (mm)

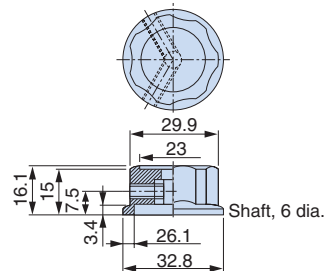

### Meter Plate for Frequency Setting Potentiometer/Frequency Meter Adjusting Potentiometer



Model	Code No.
NPJT41561-1	NPJT41561-1

#### Dimensions (mm)

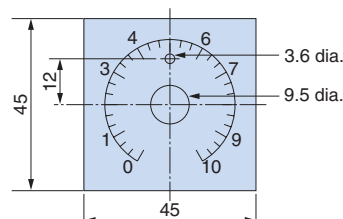



## ● Output Voltage Meter



Model	Code No.
Scale-300 V full-scale (Rectification Type Class 2.5: SCF-12NH)	VM000481
Scale-600 V full-scale (Rectification Type Class 2.5: SCF-12NH)	VM000502

### Dimensions (mm)

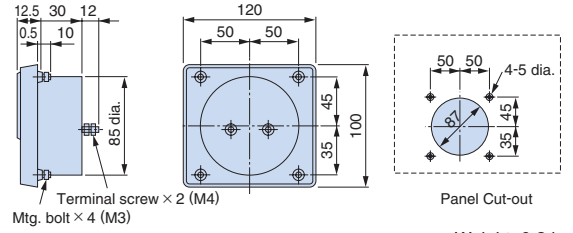

## ● Potential Transformer

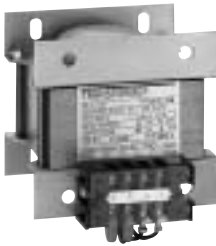

Model	Code No.
600 V Transformer for Instrument : UPN-15B 400 V/100 V	PT000084

Note: For use with a standard voltage regulator.  
A standard voltage regulator may not match the drive output voltage. Select a regulator specifically designed for the drive output (PT000084), or a voltmeter that does not use a transformer and offers direct read out.

### Dimensions (mm)

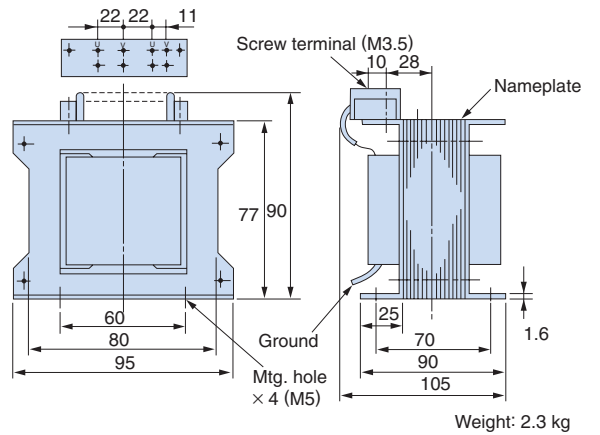

## Application Notes

### Selection

#### ■ Installing a Reactor

An AC or DC reactor can be used for the following situations:

- when the power supply is 600 kVA or more.
- to smooth peak current that results from switching a phase advance capacitor.
- to improve the power supply power factor.

A DC reactor comes standard with 200 V and 400 V class models with a capacity of 22 kW or more.

Be sure to use an AC reactor when the drive is using a power supply system with a thyristor converter.

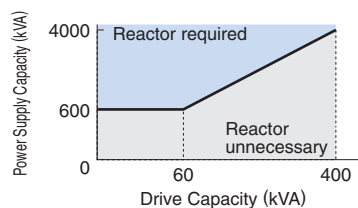

#### ■ Drive Capacity

When running a specialized motor or more than one motor in parallel from a single drive, the capacity of the drive should be larger than 1.1 times of the total motor rated current.

#### ■ Starting Torque

The overload rating for the drive determines the starting and accelerating characteristics of the motor. Expect lower torque than when running from line power. To get more starting torque, use a larger drive or increase both the motor and drive capacity.

#### ■ Emergency Stop

When the drive faults out, a protective circuit is activated and drive output is shut off. This, however, does not stop the motor immediately. Some type of mechanical brake may be needed if it is necessary to halt the motor faster than the Fast Stop function is able to.

#### ■ Options

The B1, B2, +1, and +2 terminals are used to connect optional devices. Connect only A1000-compatible devices.

#### ■ Repetitive Starting/Stopping

Cranes (hoists), elevators, punching presses, and other such applications with frequent starts and stops often exceed 150% of their rated current values. Heat stress generated from repetitive high current can shorten the lifespan of the IGBTs. The expected lifespan for the IGBTs is about 8 million start and stop cycles with a 4 kHz carrier frequency and a 150% peak current.

Yaskawa recommends lowering the carrier frequency, particularly when audible noise is not a concern. The

user can also choose to reduce the load, increase the acceleration and deceleration times, or switch to a larger drive. This will help keep peak current levels under 150%. Be sure to check the peak current levels when starting and stopping repeatedly during the initial test run, and make adjustments accordingly.

For cranes and other applications using the inching function in which the drives starts and stops the motor repeatedly, Yaskawa recommends the following steps to ensure torque levels:

- Select a large enough drive so that peak current levels remain below 150%.
- The drive should be one frame size larger than the motor.

### Installation

#### ■ Enclosure Panels

Keep the drive in a clean environment by either selecting an area free of airborne dust, lint, and oil mist, or install the drive in an enclosure panel. Leave the required space between the drives to provide for cooling, and take steps to ensure that the ambient temperature remains within allowable limits. Keep flammable materials away from the drive. If the drive must be used in an area where it is subjected to oil mist and excessive vibration, protective designs are available. Contact Yaskawa for details.

#### ■ Installation Direction

The drive should be installed upright as specified in the manual.

### Settings

- Use V/f Control when running multiple induction motors at the same time.

- If using Open Loop Vector Control designed for permanent magnet motors, make sure that the proper motor code has been set to parameter E5-01 before performing a trial run.

#### ■ Upper Limits

Because the drive is capable of running the motor at up to 400 Hz, be sure to set the upper limit for the frequency to control the maximum speed. The default setting for the maximum output frequency is 60 Hz.

#### ■ DC Injection Braking

Motor overheat can result if there is too much current used during DC Injection Braking, or if the time for DC Injection Braking is too long.



### ■ Acceleration/Deceleration Times

Acceleration and deceleration times are affected by how much torque the motor generates, the load torque, and the inertia moment ( $GD^2/4$ ). Set a longer accel/decel time when Stall Prevention is enabled. The accel/decel times are lengthened for as long as the Stall Prevention function is operating. For faster acceleration and deceleration, increase the capacity of the drive.

### Compliance with Harmonic Suppression Guidelines

A1000 conforms to strict guidelines in Japan covering harmonic suppression for power conversion devices. Defined in JEM-TR201 and JEM-TR226 and published by the Japan Electrical Manufacturers' Association, these guidelines define the amount of harmonic current output acceptable for new installation. Refer to JEM-TR226 for more information on Japanese standards for harmonic suppression for power converters.

### General Handling

#### ■ Wiring Check

Never short the drive output terminals or apply voltage to output terminals (U/T1, V/T2, W/T3), as this can cause serious damage to the drive. Doing so will destroy the drive. Be sure to perform a final check of all sequence wiring and other connections before turning the power on. Make sure there are no short circuits on the control terminals (+V, AC, etc.), as this could damage the drive.

#### ■ Magnetic Contactor Installation

Avoid switching a magnetic contactor on the power supply side more frequently than once every 30 minutes. Frequent switching can cause damage to the drive.

#### ■ Inspection and Maintenance

After shutting off the drive, make sure the CHARGE light has gone out completely before performing any inspection or maintenance. Residual voltage in drive capacitors can cause serious electric shock.

The heatsink can become quite hot during operation, and proper precautions should be taken to prevent burns. When replacing the cooling fan, shut off the power and wait at least 15 minutes to be sure that the heatsink has cooled down.

#### ■ Wiring

Make sure to use ring tongue solderless terminals when wiring UL/cUL-certified drives. Use the tools recommended by the terminal manufacturer for caulking.

### ■ Transporting the Drive

Never steam clean the drive.

During transport, keep the drive from coming into contact with salts, fluorine, bromine and other such harmful chemicals.

## ● Peripheral Devices

### ■ Installing an MCCB

Install a leakage current breaker or MCCB to the power supply side of the drive to protect internal circuitry. The type of MCCB needed depends on the power supply power factor (power supply voltage, output frequency, load characteristics, etc.).

Sometimes a fairly large MCCB may be required due to the effects of harmonic current on operating characteristics. Use a leakage breaker with harmonic suppression capability that has been designed specifically for operation with an AC drive. The rated current of the leakage breaker must be 30 mA or higher per drive unit. If a leakage breaker faults out without reducing harmonic current, then reduce the carrier frequency of the drive, replace it with a breaker that has better harmonic suppression capabilities, or provide a leakage breaker with at least a 200 mA current rating to each drive unit.

### ■ Magnetic Contactor for Input Power

Use a magnetic contactor (MC) to ensure that power to the drive can be completely shut off when necessary. The MC should be wired so that it opens when a fault output terminal is triggered.

Even though an MC is designed to switch to a momentary power loss, frequent MC use can damage other components. Avoid switching the MC more than once every 30 minutes. The MC will not be activated after a momentary power loss if using the operator keypad to run the drive. This is because the drive is unable to restart automatically when set for LOCAL. Although the drive can be stopped by using an MC installed on the power supply side, the drive cannot stop the motor in a controlled fashion, and it will simply coast to stop. If a braking resistor or dynamic braking unit has been installed, be sure to set up a sequence that opens the MC with a thermal protector switch connected to the braking resistor device.

### ■ Magnetic Contactor for Motor

As a general principle, the user should avoid opening and closing the magnetic contactor between the motor and the drive during run. Doing so can cause high peak currents and overcurrent faults. If magnetic contactors are used to bypass the drive by connecting the motor to the power supply directly, make sure to close the bypass

only after the drive is stopped and fully disconnected from the motor. The Speed Search function can be used to start a coasting motor.

Use an MC with delayed release if momentary power loss is a concern.

### Motor Thermal Over Load Relay Installation

Although the drive comes with built in electrothermal protection to prevent damage from overheat, a thermal relay should be connected between the drive and each motor if running several motors from the same drive. For a multi-pole motor or some other type of non-standard motor, Yasukawa recommends using an external thermal relay appropriate for the motor. Be sure to disable the motor protection selection parameter (L1-01 = 0), and set the thermal relay or thermal protection value to 1.1 times the motor rated current listed on the motor nameplate.

### Improving the Power Factor

Installing a DC or AC reactor to the input side of the drive can help improve the power factor.

Refrain from using a capacitor or surge absorber on the output side as a way of improving the power factor, because harmonic contents on the output side can lead to damage from overheat. This can also lead to problems with overcurrent.

### Radio Frequency Interference

Drive output contains harmonic contents that can affect the performance of surrounding electronic instruments such as an AM radio. These problems can be prevented by installing a noise filter, as well as by using a properly grounded metal conduit to separate wiring between the drive and motor.

### Wire Gauges and Wiring Distance

Motor torque can suffer as a result of voltage loss across a long cable running between the drive and motor, especially when there is low frequency output. Make sure that a large enough wire gauge is used.

The optional LCD operator requires a proprietary cable to connect to the drive. If an analog signal is used to operate the drive via the input terminals, make sure that the wire between the analog operator and the drive is no longer than 50 m, and that it is properly separated from the main circuit wiring. Use reinforced circuitry (main circuit and relay sequence circuitry) to prevent inductance from surrounding devices. To run the drive with a frequency potentiometer via the external terminals, use twisted shielded pair cables and ground the shield.

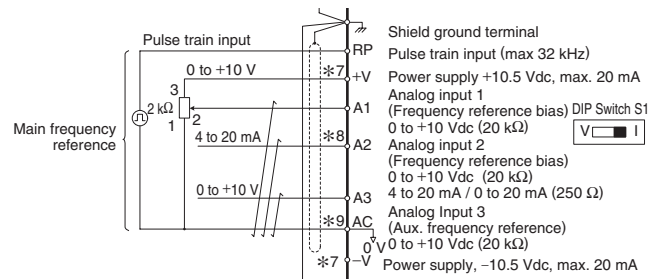

### Counteracting Noise

Because A1000 is designed with PWM control, a low carrier frequency tends to create more motor flux noise than using a higher carrier frequency. Keep the following points in mind when considering how to reduce motor noise:

- Lowering the carrier frequency minimizes the effects of noise.
- A line noise filter can reduce the affects on AM radio frequencies and poor sensor performance. See “Options and Peripheral Devices” on page 24.
- Make sure the distance between signal and power lines is at least 10 cm (up to 30 cm is preferable), and use twisted pair cable to prevent induction noise from the drive power lines.

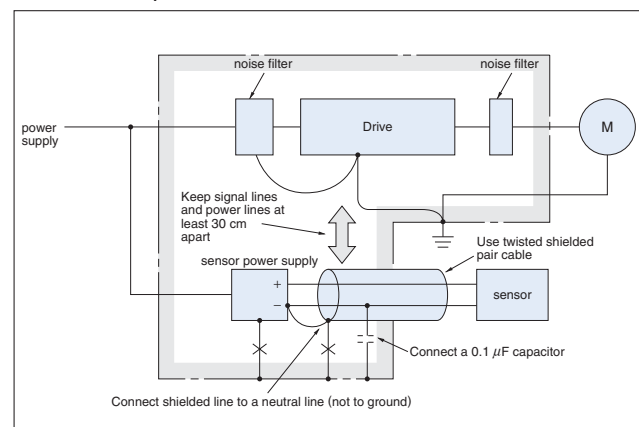

<Provided by JEMA>

### Leakage Current

Harmonic leakage current passes through stray capacitance that exists between the power lines to the drive, ground, and the motor lines. Consider using the following peripheral devices to prevent problems with leakage current.

	Problem	Solution
Ground Leakage Current	MCCB is mistakenly triggered	<ul style="list-style-type: none"> <li>• Lower the carrier frequency set to parameter C6-02.</li> <li>• Try using a component designed to minimize harmonic distortion for the MCCB such as the NV series by Mitsubishi.</li> </ul>
Current Leakage Between Lines	Thermal relay connected to the external terminals is mistakenly triggered by harmonics in the leakage current	<ul style="list-style-type: none"> <li>• Lower the carrier frequency set to parameter C6-02.</li> <li>• Use the drive's built-in thermal motor protection function.</li> </ul>



### Setting the Carrier Frequency Relative to Wiring Distance

Wiring Distance	50 m or less	100 m or less	100 m or more
C6-02: Carrier Frequency Selection	1 to A (15 kHz or less)	1, 2, 7 to A (5 kHz or less)	1, 7 to A (2 kHz or less)

When running multiple motors from a single drive, remember that the motor cable length is determined as the total length of all motor cables combined.

Use V/f Control when motor wiring is longer than 100 m. Because V/f Control is not possible with a PM motor, be sure to keep motor wiring shorter than 100 m when using a PM motor.

Speed Search should be set for Current Detection Speed Search when running multiple motors.

## Notes on Motor Operation

### Using a Standard Motor

#### Low Speed Range

There is a greater amount of loss when operating a motor using an drive than when running directly from line power. With a drive, the motor can become quite hot due to the poor ability to cool the motor at low speeds. The load torque should be reduced accordingly at low speeds. The figure above shows the allowable load characteristics for a standard Yaskawa motor. A motor designed specifically for operation with a drive should be used when 100% continuous torque is needed at low speeds.

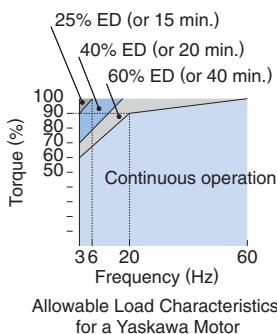

#### Insulation Tolerance

Consider voltage tolerance levels and insulation in applications with an input voltage of over 440 V or particularly long wiring distances. Contact Yaskawa for consultation.

#### High Speed Operation

Problems may occur with the motor bearings and dynamic balance in applications operating at over 60 Hz. Contact Yaskawa for consultation.

#### Torque Characteristics

Torque characteristics differ when operating directly from line power. The user should have a full understanding of the load torque characteristics for the application.

#### Vibration and Shock

A1000 lets the user choose between high carrier PWM control and low carrier PWM. Selecting high carrier PWM can help reduce motor oscillation. Keep the fol-

lowing points in mind when using high carrier PWM:

#### (1) Resonance

Take particular caution when using a variable speed drive for an application that is conventionally run from line power at a constant speed. Shock-absorbing rubber should be installed around the base of the motor and the Jump Frequency selection should be enabled to prevent resonance.

#### (2) Any imperfection on a rotating body increases vibration with speed.

Caution should be taken when operating above the motor rated speed.

#### Audible Noise

Noise created during run varies by the carrier frequency setting. Using a high carrier frequency creates about as much noise as running from line power. Operating above the rated speed (i.e., above 60 Hz), however, can create unpleasant motor noise.

### Using a Synchronous Motor

Please contact us for consultation when using a synchronous motor not already approved by Yaskawa.

For applications running a synchronous motor with the drive set for Heavy Duty performance (particularly hoists and conveyor applications), use Closed Loop Vector Control for PM (A1-02 = 7). Contact Yaskawa for details.

When the power to a drive running a PM motor is shut off, voltage continues to be generated at the motor terminals while the motor coasts to stop. Take the precautions described below to prevent shock and injury:

- Applications where the machine can still rotate even though the drive has fully stopped should have a load switch installed to the output side of the drive. Yaskawa recommends manual load switches from the AICUT LB Series by Aichi Electric Works Co., Ltd.
- Do not connect to a load that could potentially rotate the motor faster than the maximum allowable speed even when the drive has been shut off.
- Wait at least one minute after opening the load switch on the output side before inspecting the drive or performing any maintenance.
- Do not open and close the load switch while the motor is running, as this can damage the drive.
- If the motor is coasting, make sure the power to the drive is turned on and the drive output has completely stopped before closing the load switch.

- Synchronous motors cannot be started directly from line power. Applications requiring line power to start should use an induction motor with the drive.
- A single drive is not capable of running multiple synchronous motors at the same time. Use a standard induction motor for such setups.
- At start, a synchronous motor may rotate slightly in the opposite direction of the Run command depending on parameter settings and motor type.
- The amount of starting torque that can be generated differs by the type of motor being used. Set up the motor with the drive after verifying the starting torque, allowable load characteristics, impact load tolerance, and speed control range.  
Contact Yaskawa if you plan to use a motor that does not fall within these specifications.
- Even with a braking resistor, braking torque is less than 125% when running between 20% to 100% speed, and falls to less than half the braking torque when running at less than 20% speed.
- The allowable load inertia moment is 50 times less than the motor inertia moment. Contact Yaskawa concerning applications with a larger inertia moment.
- When using a holding brake, release the brake prior to starting the motor. Failure to set the proper timing can result in speed loss. Conveyor, transport, and hoist applications using a holding brake should run an IPM motor in Closed Loop Vector Control for PM motors.
- To restart a coasting motor rotating at over 120 Hz, use the Short Circuit Braking\* function to first bring the motor to a stop. Short Circuit Braking requires a special braking resistor. Contact Yaskawa for details.  
Speed Search can be used to restart a coasting motor rotating slower than 120 Hz. If the motor cable is relatively long, however, the motor should instead be stopped using Short Circuit Braking and then restarted.

\* Short Circuit Braking creates a short-circuit in the motor windings to forcibly stop a coasting motor.

## ● Applications with Specialized Motors

- **Multi-Pole Motor**  
Because the rated current will differ from a standard motor, be sure to check the maximum current when selecting a drive. Always stop the motor before switching between the number of motor poles. If a regen overvoltage fault occurs or if overcurrent protection is triggered, the motor will coast to stop.
- **Submersible Motor**  
Because motor rated current is greater than a standard motor, select the drive capacity accordingly. Be sure to use a large enough motor cable to avoid decreasing the maximum torque level on account of voltage drop caused by a long motor cable.
- **Explosion-Proof Motor**  
Both the motor and drive need to be tested together to be certified as explosion-proof. The drive is not for explosion proof areas.  
An explosion-proof pulse generators (PG) is used for an explosion-proof with voltage tolerance. Use a specially designed pulse coupler between the drive and the PG when wiring.
- **Geared Motor**  
Continuous operation specifications differ by the manufacturer of the lubricant. Due to potential problems of gear damage when operating at low speeds, be sure to select the proper lubricant. Consult with the manufacturer for applications that require speeds greater than the rated speed range of the motor or gear box.
- **Single-Phase Motor**  
Variable speed drives are not designed for operating single phase motors. Using a capacitor to start the motor causes excessive current to flow into the capacitors, potentially causing damage. A split-phase start or a repulsion start can end up burning out the starter coils because the internal centrifugal switch is not activated. A1000 is for use only with 3-phase motors.
- **Uras Vibrator**  
Uras vibrator is a vibration motor that gets power from centrifugal force by rotating unbalanced weights on both ends of the shaft. Make the following considerations when selecting a drive for use with an Uras vibrator:
  - (1) Uras vibrator should be used within the drive rated frequency
  - (2) Use V/f Control



- (3) Increase the acceleration time five to fifteen times longer than would normally be used due to the high amount of load inertia of an Uras vibrator

Note: Contact Yaskawa for applications that require an acceleration time of less than 5 s.

- (4) Drive may have trouble starting due to undertorque that results from erratic torque (static friction torque at start)

#### ■ Motor with Brake

Caution should be taken when using a drive to operate a motor with a built-in holding brake. If the brake is connected to the output side of the drive, it may not release at start due to low voltage levels. A separate power supply should be installed for the motor brake. Motors with a built-in brake tend to generate a fair amount of noise when running at low speeds.

#### Power Driven Machinery (decelerators, belts, chains, etc.)

Continuous operation at low speeds wears on the lubricating material used in gear box type systems to accelerate and decelerate power driven machinery. Caution should also be taken when operating at speeds above the rated machine speed due to noise and shortened performance life.



# YASKAWA AC Drive Series

Name	Feature	Capacity Range (kW)		Outline	
		0.1	1 10 100 300 630		
J1000	Compact V/f Control AC Drive	Three-Phase 200 V Class	0.1  5.5	<ul style="list-style-type: none"> <li>Ultra-small body enables side-by-side installation. Compact design of enclosure panel</li> <li>Easy operation with the Potentiometer Option Unit</li> <li>The noise-suppressing Swing PWM system reduces harsh sound.</li> <li>The full-range fully-automatic torque boost function provides high torque output. (100%/1.5 Hz, 150%/3 Hz)</li> <li>The Stall Prevention function and the speed search function ensure continuous operation, regardless of load/power supply fluctuations or momentary power loss.</li> <li>The Overexcitation braking function enables rapid braking, without using a braking resistor.</li> </ul>	
		Single-Phase 200 V Class	0.1  2.2		
		Three-Phase 400 V Class	0.2  5.5		
V1000	Compact Vector Control AC Drive	Three-Phase 200 V Class	0.1  18.5	<ul style="list-style-type: none"> <li>Small body and high performance (Current vector control)</li> <li>New technology for driving synchronous motors (IPMM/SPMM) as well as induction motors</li> <li>High starting torque: 200%/0.5 Hz* Torque limit function * At Heavy Duty rating, for induction motors with 3.7 kW or lower</li> <li>Application-specific function selection for simplified optimum setup</li> <li>Easy maintenance using the detachable terminal block with the parameter backup function</li> </ul>	
		Single-Phase 200 V Class	0.1  3.7		
		Three-Phase 400 V Class	0.2  18.5		
A1000	Advanced Vector Control AC Drive	Three-Phase 200 V Class	0.4  110	<ul style="list-style-type: none"> <li>New technology for driving synchronous motors (IPMM/SPMM) as well as induction motors</li> <li>High starting torque IPM motor without a motor encoder: 0 r/min 200% torque</li> <li>Application preset function selection for simplified optimum setup</li> <li>Easy maintenance using the detachable terminal block with the parameter backup function</li> </ul>	
		Three-Phase 400 V Class	0.4  630		
Varispeed F7	Advanced Current Vector Control General-purpose Inverter Minimal Noise	Three-Phase 200 V Class	0.4  110	<ul style="list-style-type: none"> <li>Open Loop Vector control ensures 150% or higher torque during operation at 0.5 Hz. Flux Vector Control provides high torque of 150% at zero speed.</li> <li>Easy maintenance and inspection using the detachable control circuit terminals and the detachable cooling fan</li> <li>PID control and energy-saving control</li> <li>The Auto-Tuning function upgrades all types of general motors to be compatible with high-performance drives.</li> </ul>	
		Three-Phase 400 V Class	0.4  300		
Varispeed G7	General-purpose Inverter With Advanced Vector Control Minimal Noise	Three-Phase 200 V Class	0.4  110	<ul style="list-style-type: none"> <li>The 400 V class uses 3-level control for a more perfect output waveform.</li> <li>Open Loop Vector control ensures 150% or higher torque during operation at 0.3 Hz. Flux Vector Control provides a high torque of 150% at zero speed.</li> <li>Easy maintenance and inspection using the detachable control circuit terminals and the detachable cooling fan.</li> <li>Software for various applications (for crane, hoist, etc.)</li> <li>The Auto-Tuning function upgrades all types of general motors to be compatible with high-performance drives.</li> </ul>	
		Three-Phase 400 V Class	0.4  300		
Varispeed AC	Environmentally Friendly Motor Drives Matrix Converter	Three-Phase 200 V Class	5.5  45	<ul style="list-style-type: none"> <li>The world's first matrix converter system that outputs AC voltage from AC voltage, and includes power supply regeneration capabilities.</li> <li>The simple, highly-efficient drive can remarkably reduce power supply harmonics, without using peripherals.</li> </ul>	
		Three-Phase 400 V Class	5.5  75		
Varispeed F7S	Super Energy-Saving Variable Speed Drive	Three-Phase 200 V Class	0.4  75	<ul style="list-style-type: none"> <li>Enables continuous operation of a synchronous motor (without PG) after momentary power loss, and startup of a coasting synchronous motor (without PG).</li> <li>Enables compact configuration of building air-conditioning system using LONWORKS.</li> </ul>	
		Three-Phase 400 V Class	0.4  300*		
Special Use	Vector-controlled Inverter Drives With Power Regenerative Function For Machine Tools	Three-Phase 200 V Class	3.7  37	<ul style="list-style-type: none"> <li>For multiple-axis drive systems</li> <li>For machine tool spindle drives</li> <li>High-precision, quick-response, high-reliability AC drive system capable of using vector control to run a high-speed AC motor.</li> </ul>	
		Three-Phase 400 V Class	5.5  45		
		Three-Phase 200 V Class	3.7  37		
		Three-Phase 400 V Class	5.5  45		
	VS-626MC5	High-frequency Inverter Drives	Three-Phase 200 V Class	0.4  75	<ul style="list-style-type: none"> <li>For machine tool spindle drives</li> <li>Drive system capable of using vector control to run a high-speed AC motor.</li> </ul>
			Three-Phase 400 V Class	0.4  75	
VS-646HF5	High-frequency Inverter Drives	Three-Phase 200 V Class	2.2  7.5	<ul style="list-style-type: none"> <li>Provides a high rotation speed of 420,000 r/min in combination with a high-speed (2-pole) motor</li> </ul>	

\* Maximum capacity without PG: 160 kW





# Global Service Network



Region	Service Area	Service Location	Service Agency	Telephone/Fax
North America	U.S.A.	Chicago (HQ) Los Angeles New Jersey Boston San Francisco Ohio North Carolina	① YASKAWA ELECTRIC AMERICA INC.	Headquarters ☎ +1-847-887-7303 FAX +1-847-887-7070
	Mexico	Mexico City	② PILLAR MEXICANA. S.A. DE C.V.	☎ +52-555-660-5553 FAX +52-555-651-5573
South America	South America	São Paulo	③ YASKAWA ELÉCTRICO DO BRASIL LTD.A.	☎ +55-11-3585-1100 FAX +55-11-5581-8795
	Colombia	Bogota	④ VARIADORES LTD.A.	☎ +57-1-428-4225 FAX +57-1-428-2173
Europe	Europe, South Africa	Frankfurt	⑤ YASKAWA ELECTRIC EUROPE GmbH	☎ +49-6196-569-300 FAX +49-6196-569-398
			⑥ YASKAWA ENGINEERING EUROPE GmbH	☎ +49-6196-569-520 FAX +49-6196-888-598
Asia	Japan	Tokyo, offices nationwide	⑦ YASKAWA ELECTRIC CORPORATION (Manufacturing, sales)	☎ +81-3-5402-4502 FAX +81-3-5402-4580
			⑧ YASKAWA ELECTRIC ENGINEERING CORPORATION (After-sales service)	☎ +81-4-2931-1810 FAX +81-4-2931-1811
	South Korea	Seoul	⑨ YASKAWA ELECTRIC KOREA CORPORATION	☎ +82-2-784-7844 FAX +82-2-784-8495
			⑩ YASKAWA ENGINEERING KOREA Co.	☎ +82-2-3775-0337 FAX +82-2-3775-0338
	China	Beijing, Shanghai, Guangzhou	⑪ YASKAWA ELECTRIC (SHANGHAI) Co., Ltd.	☎ +86-21-5385-2200 FAX +86-21-5385-3299
	Taiwan	Taipei	⑫ YASKAWA ELECTRIC TAIWAN Co.	☎ +886-2-2502-5003 FAX +886-2-2505-1280
	Singapore	Singapore	⑬ YASKAWA ELECTRIC (SINGAPORE) Pte. Ltd.	☎ +65-6282-3003 FAX +65-6289-3003
			⑭ YASKAWA ENGINEERING ASIA-PACIFIC Pte. Ltd.	☎ +65-6282-1601 FAX +65-6282-3668
	Thailand	Bangkok	⑮ YASKAWA ELECTRIC (THAILAND) Co., Ltd.	☎ +66-2-693-2200 FAX +66-2-693-2204
	India	Mumbai	⑯ LARSEN & TOUBRO LIMITED	Headquarters ☎ +91-22-67226200 +91-22-27782230 FAX +91-22-27783032
Oceania	Australia	Sydney (HQ) Melbourne	⑰ ROBOTIC AUTOMATION Pty. Ltd.	Headquarters ☎ +61-2-9748-3788 FAX +61-2-9748-3817

# A1000

---

**IRUMA BUSINESS CENTER (SOLUTION CENTER)**

480, Kamifujisawa, Iruma, Saitama 358-8555, Japan  
Phone: 81-4-2962-5696 Fax: 81-4-2962-6138

**YASKAWA ELECTRIC CORPORATION**

New Pier Takeshiba South Tower, 1-16-1, Kaigan, Minatoku, Tokyo, 105-6891, Japan  
Phone: 81-3-5402-4511 Fax: 81-3-5402-4580  
<http://www.yaskawa.co.jp>

**YASKAWA ELECTRIC AMERICA, INC.**

2121 Norman Drive South, Waukegan, IL 60085, U.S.A.  
Phone: (800) YASKAWA (800-927-5292) or 1-847-887-7000 Fax: 1-847-887-7370  
<http://www.yaskawa.com>

**YASKAWA ELÉTRICO DO BRASIL COMÉRCIO LTDA.**

Avenda Fagundes Filho, 620 Bairro Saude, São Paulo, SP04304-000, Brasil  
Phone: 55-11-3585-1100 Fax: 55-11-5581-8795  
<http://www.yaskawa.com.br>

**YASKAWA ELECTRIC EUROPE GmbH**

Hauptstraße 185, 65760 Eschborn, Germany  
Phone: 49-6196-569-300 Fax: 49-6196-569-398

**YASKAWA ELECTRIC UK LTD.**

1 Hunt Hill Orchardton Woods, Cumbernauld, G68 9LF, United Kingdom  
Phone: 44-1236-735000 Fax: 44-1236-458182

**YASKAWA ELECTRIC KOREA CORPORATION**

7F, Doore Bldg. 24, Yeoido-dong, Youngdungpo-Ku, Seoul, 150-877, Korea  
Phone: 82-2-784-7844 Fax: 82-2-784-8495

**YASKAWA ELECTRIC (SINGAPORE) PTE. LTD.**

151 Lorong Chuan, #04-02A, New Tech Park, 556741, Singapore  
Phone: 65-6282-3003 Fax: 65-6289-3003

**YASKAWA ELECTRIC (SHANGHAI) CO., LTD.**

No.18 Xizang Zhong Road, Room 1702-1707, Harbour Ring Plaza, Shanghai, 200001, China  
Phone: 86-21-5385-2200 Fax: 86-21-5385-3299

**YASKAWA ELECTRIC (SHANGHAI) CO., LTD. BEIJING OFFICE**

Room 1011A, Tower W3 Oriental Plaza, No.1 East Chang An Ave.,  
Dong Cheng District, Beijing, 100738, China  
Phone: 86-10-8518-4086 Fax: 86-10-8518-4082

**YASKAWA ELECTRIC TAIWAN CORPORATION**

9F, 16, Nanking E. Rd., Sec. 3, Taipei, Taiwan  
Phone: 886-2-2502-5003 Fax: 886-2-2505-1280



YASKAWA

YASKAWA ELECTRIC CORPORATION

In the event that the end user of this product is to be the military and said product is to be employed in any weapons systems or the manufacture thereof, the export will fall under the relevant regulations as stipulated in the Foreign Exchange and Foreign Trade Regulations. Therefore, be sure to follow all procedures and submit all relevant documentation according to any and all rules, regulations and laws that may apply. Specifications are subject to change without notice for ongoing product modifications and improvements.  
© 2008-2009 YASKAWA ELECTRIC CORPORATION. All rights reserved.

LITERATURE NO. KAEP C710616 22E

Published in Japan October 2009 08-7 ◀-0  
09-8-2



Printed on 100% recycled paper  
with soybean oil ink.