

Machine Controller MP2300

Basic Module

USER'S MANUAL

Model: JEPMC-MP2300

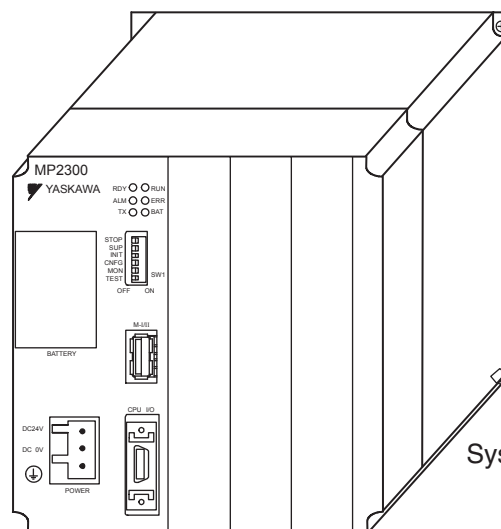

Overview of the MP2300

1

Module Specifications

2

Mounting and Connections

3

System Startup and Sample Programs

4

Outline of Motion Control Systems

5

Maintenance and Inspection

6

Appendices

App

Copyright © 2003 YASKAWA ELECTRIC CORPORATION

All rights reserved. No part of this publication may be reproduced, stored in a retrieval system, or transmitted, in any form, or by any means, mechanical, electronic, photocopying, recording, or otherwise, without the prior written permission of Yaskawa. No patent liability is assumed with respect to the use of the information contained herein. Moreover, because Yaskawa is constantly striving to improve its high-quality products, the information contained in this manual is subject to change without notice. Every precaution has been taken in the preparation of this manual. Nevertheless, Yaskawa assumes no responsibility for errors or omissions. Neither is any liability assumed for damages resulting from the use of the information contained in this publication.

Using this Manual

The MP2300 is a compact Machine Controller that contains the power supply, the CPU, I/O, and the communication functions in one single unit.

Please read this manual to ensure correct usage of the MP2300 system. Keep this manual in a safe place for future reference.

Read this manual carefully to ensure the proper use of the MP2300. Also, keep this manual in a safe place so that it can be referred to whenever necessary.

■ Basic Terms

Unless otherwise specified, the following definitions are used:

- MP2300: MP2300 Machine Controller
- PC: Programmable Logic Controller
- PP: Programming Panel
- MPE720: The Programming Device Software or a Programming Device (i.e., a personal computer) running the Programming Device Software

■ Manual Configuration

Read the chapters of this manual as required by the purpose.

Chapter	Selecting Models and Peripheral Devices	Studying Specifications and Ratings	Designing the System	Installation and Wiring	Trial Operation	Maintenance and Inspection
Chapter 1 Overview of the MP2300	√	√	–	–	–	–
Chapter 2 Module Specifications	√	√	–	√	√	√
Chapter 3 Mounting and Connections	√	√	√	√	√	√
Chapter 4 System Startup and Sample Programs	–	–	√	–	√	–
Chapter 5 Outline of Motion Control Systems	–	√	√	–	–	–
Chapter 6 Maintenance and Inspection	–	–	√	√	√	√

■ Graphic Symbols Used in this Manual

The graphic symbols used in this manual indicate the following type of information.



- This symbol is used to indicate important information that should be memorized or minor precautions, such as precautions that will result in alarms if not heeded.

■ Terms Used to Describe “Torque”

Although the term "torque" is commonly used when describing rotary servomotors and "force" or "thrust" are used when describing linear servomotors, this manual uses "torque" when describing both (excluding parameters).

■ Indication of Reverse Signals

In this manual, the names of reverse signals (ones that are valid when low) are written with a forward slash (/) before the signal name, as shown in the following example:

Notation Examples

- $\overline{S-ON}$ = /S-ON
- $\overline{P-CON}$ = /P-CON

■ Related Manuals

The following table lists the manuals relating to the MP2300. Refer to these manuals as required.

Manual Name	Manual Number	Contents
Machine Controller MP2000 Series Built-in SVB/SVB-01 Motion Module User's Manual	SIEP C880700 33	Describes the functions, specifications, and application methods of the MP2000 Series Motion Module that is built into the SVB, SVB-01, and SVR Module.
Machine Controller MP2000 Series Built-in SVA-01 Motion Module User's Manual	SIEP C880700 32	Describes the functions, specifications, and application methods of the SVA-01, SVA Motion Module for the MP2000 Series.
Machine Controller MP2000 Series Pulse Output Motion Module PO-01 User's Manual	SIEP C880700 28	Describes the functions, specifications, and application methods of the PO-01, Pulse Output Motion Module for the MP2000 Series.
Machine Controller MP2000 Series Communication Module User's Manual	SIEP C880700 04	Describes the functions, specifications, and application methods of the MP2000 Series Communication Modules (217IF, 218IF, 260IF, 261IF).
Machine Controller MP2000 Series I/O Module User's Manual	SIEP C880700 34	Describes the functions, specifications, and application methods of the I/O Module for the MP2000 Series.
Machine Controller MP2000 Series Analog Input/Analog Output Module AI-01/AO-01 User's Manual	SIEP C880700 26	Describes the functions, specifications, and application methods of the Analog Input Module AI-01 and Analog Output Module AO-01 for the MP2000 Series.
Machine Controller MP2000 Series Counter Module CNTR-01 User's Manual	SIEP C880700 27	Describes the functions, specifications, and application methods of the Counter Module CNTR-01 for the MP2000 Series.
Machine Controller MP900/MP2000 Series User's Manual, Ladder Programming	SIEZ-C887-1.2	Describes the instructions used in MP900/MP2000 ladder programming.
Machine Controller MP900/MP2000 Series User's Manual Motion Programming	SIEZ-C887-1.3	Describes the instructions used in MP900/MP2000 motion programming.
Engineering Tool for MP2000 Series Machine Controller MPE720 Version 6 User's Manual	SIEP C880700 30	Describes the installation and operation of the engineering tools for MP2000 Series Machine Controller MPE720 Version 6.
Machine Controller MP900/MP2000 Series MPE720 Software for Programming Device User's Manual	SIEP C880700 05	Describes how to install and operate the MP900/MP2000 Series programming system (MPE720).
Σ Series SGM \square /SGD User's Manual	SIEZ-S800-26.3	Describes the Σ Series SERVOPACK models, specifications, and capacity selection methods.
Σ Series SGM \square /SGD User's Manual High-speed Field Network MECHATROLINK-compatible AC Servo Drivers	SIEZ-S800-26.4	Describes the Σ Series SERVOPACK models, specifications, and capacity selection methods.
Σ -II Series SGM \square H/SGDH User's Manual	SIEP S800000 05	Describes the installation, wiring, trial operation, function applications methods, maintenance, and inspection of the Σ -II Series SERVOPACKs.
Σ -II Series SGM \square H/SGDM User's Manual	SIEP S800000 15	Describes the installation, wiring, trial operation, function applications methods, maintenance, and inspection of the Σ -II Series SERVOPACKs.

Manual Name	Manual Number	Contents
Σ-III Series SGM□H/SGDS User's Manual	SIEP S800000 00	Describes the models, specifications, wiring, trial operation, adjustment, function application methods, maintenance, and inspection of the Σ-III Series SERVOPACKs and Servomotors.
Σ-III Series SGM□S/SGDS Digital Operator Operating Instructions	TOBP S800000 01	Describes the operating methods of the JUSP-OP05A Digital Operator.
Σ-III Series SGM□S/SGDS MECHATROLINK-II SERVOPACKs with Communication User's Manual	SIEP S800000 11	Describes the models, specifications, wiring, trial operation, adjustment, function application methods, maintenance, inspection, and MECHATROLINK communication of the Σ-III Series SERVOPACKs and Servomotors.
AC Servodrive Σ-V Series User's Manual Setup Rotational Motor	SIEP S800000 43	Describes the installation, wiring, connection, and trial operation of the Σ-V Series servodrives and rotational servomotors.
AC Servodrive Σ-V Series User's Manual Setup Linear Motor	SIEP S800000 44	Describes the installation, wiring, connection, and trial operation of the Σ-V Series servodrives and linear servomotors.
AC Servodrive Σ-V Series SGM□□/SGDV User's Manual Design and Maintenance	SIEP S800000 45	Describes the maintenance of the Σ-V Series analog servodrives and rotational servomotors.
AC Servodrive Σ-V Series User's Manual Design and Maintenance Rotational Motor	SIEP S800000 46	Describes the maintenance of the Σ-V Series servodrives with MECHATROLINK-II communications and rotational servomotors.
AC Servodrive Σ-V Series User's Manual Design and Maintenance Linear Motor	SIEP S800000 47	Describes the maintenance of the Σ-V Series analog servodrives and linear servomotors.
AC Servodrive Σ-V Series User's Manual Design and Maintenance Rotational Motor	SIEP S800000 48	Describes the maintenance of the Σ-V Series servodrives with MECHATROLINK-II communications and linear servomotors.
AC Servodrive Σ-V Series User's Manual MECHATROLINK-II Command	SIEP S800000 54	Describes the MECHATROLINK-II communications commands of the Σ-V Series servodrives with MECHATROLINK-II communications and rotational servomotors.
AC Servodrive Σ-V Series User's Manual Operation of Digital Operator SGD V SERVOPACK	SIEP S800000 55	Describes the MECHATROLINK-II communications commands of the Σ-V Series servodrives with MECHATROLINK-II communications and linear servomotors.
Machine Controller MP900/MP2000 Series Linear Servomotor Manual	SIEP C880700 06	Describes the connection methods, setting methods, and other information for Linear Servomotors.
Machine Controller MP900/MP2000 Series New Ladder Editor User's Manual Programming Manual	SIEZ-C887-13.1	Describes the programming instructions of the New Ladder Editor, which assists MP900/MP2000 Series design and maintenance.
Machine Controller MP900/MP2000 Series New Ladder Editor User's Manual Operation	SIEZ-C887-13.2	Describes the operating methods of the New Ladder Editor, which assists MP900/MP2000 Series design and maintenance.
Machine Controller MP900/MP2000 Series User's Manual, MECHATROLINK System	SIEZ-C887-5.1	Describes MECHATROLINK distributed I/O for MP900/MP2000 Series Machine Controllers.

■ Copyrights

- DeviceNet is a registered trademark of the ODVA (Open DeviceNet Vendors Association).
- PROFIBUS is a trademark of the PROFIBUS User Organization.
- Ethernet is a registered trademark of the Xerox Corporation.
- MPLINK is a registered trademark of the YASKAWA Electric Corporation.
- Microsoft, Windows, Windows NT, and Internet Explorer are registered trademarks of the Microsoft Corporation.
- MECHATROLINK is a trademark of the MECHATROLINK Members Association.
- Other product names and company names are the trademarks or registered trademarks of the respective company. "TM" and the ® mark do not appear with product or company names in this manual.

Safety Information

The following conventions are used to indicate precautions in this manual. These precautions are provided to ensure the safe operation of the MP2300 and connected devices. Information marked as shown below is important for the safety of the user. Always read this information and heed the precautions that are provided.

The conventions are as follows:



Indicates precautions that, if not heeded, could possibly result in loss of life, serious injury, or property damage.



Indicates precautions that, if not heeded, could result in relatively serious or minor injury, or property damage.

If not heeded, even precautions classified under  CAUTION can lead to serious results depending on circumstances.



Indicates prohibited actions. Specific prohibitions are indicated inside .

For example,  indicates prohibition of open flame.



Indicates mandatory actions. Specific actions are indicated inside .

For example,  indicates mandatory grounding.

Safety Precautions

The following precautions are for checking products on delivery, storage, transportation, installation, wiring, operation, application, inspection, and disposal. These precautions are important and must be observed.

■ General Precautions

WARNING

- Before connecting the machine and starting operation, ensure that an emergency stop procedure has been provided and is working correctly.
There is a risk of injury.
- Do not touch anything inside the MP2300.
There is a risk of electrical shock.
- Always keep the front cover attached when power is being supplied.
There is a risk of electrical shock.
- Observe all procedures and precautions given in this manual for trial operation.
Operating mistakes while the servomotor and machine are connected may damage the machine or even cause accidents resulting in injury or death.
There is a risk of electrical shock.
- Do not remove the front cover, cables, connector, or options while power is being supplied.
There is a risk of electrical shock.
- Do not damage, pull on, apply excessive force to, place heavy objects on, or pinch cables.
There is a risk of electrical shock, operational failure or burning of the MP2300.
- Do not attempt to modify the MP2300 in any way.
There is a risk of injury or device damage.
- Do not approach the machine when there is a momentary interruption to the power supply. When power is restored, the MP2300 and the device connected to it may start operation suddenly. Provide safety measures in advance to ensure human safety in the event that operation restarts suddenly.
There is a risk of injury.
- Do not allow installation, disassembly, or repairs to be performed by anyone other than specified personnel.
There is a risk of electrical shock or injury.

■ Storage and Transportation

CAUTION

- Do not store or install the MP2300 in the following locations.
There is a risk of fire, electrical shock, or device damage.
 - Direct sunlight
 - Ambient temperature exceeds the storage or operating conditions
 - Ambient humidity exceeds the storage or operating conditions
 - Rapid changes in temperature or locations subject to condensation
 - Corrosive or flammable gas
 - Excessive dust, dirt, salt, or metallic powder
 - Water, oil, or chemicals
 - Vibration or shock
- Do not overload the MP2300 during transportation.
There is a risk of injury or an accident.
- Never subject the product to an atmosphere containing halogen (fluorine, chlorine, bromine, or iodine) during transportation or installation.
There is a risk of device damage or an accident.
- If disinfectants or insecticides must be used to treat packing materials such as wooden frames, pallets, or plywood, the packing materials must be treated before the product is packaged, and methods other than fumigation must be used.
Example: Heat treatment, where materials are kiln-dried to a core temperature of 56°C for 30 minutes or more.

If the electronic products, which include stand-alone products and products installed in machines, are packed with fumigated wooden materials, the electrical components may be greatly damaged by the gases or fumes resulting from the fumigation process. In particular, disinfectants containing halogen, which includes chlorine, fluorine, bromine, or iodine can contribute to the erosion of the capacitors.

■ Installation

CAUTION

- Never use the MP2300 in locations subject to water, corrosive atmospheres, or flammable gas, or near burnable objects.
There is a risk of electrical shock or fire.
- Do not step on the MP2300 or place heavy objects on the MP2300.
There is a risk of injury.
- Do not block the air exhaust port or allow foreign objects to enter the MP2300.
There is a risk of element deterioration inside, an accident, or fire.
- Always mount the MP2300 in the specified orientation.
There is a risk of an accident.
- Do not subject the MP2300 to strong shock.
There is a risk of an accident.

■ Wiring

⚠ CAUTION

- Check the wiring to be sure it has been performed correctly.
There is a risk of motor run-away, injury, or an accident.
- Always use a power supply of the specified voltage.
There is a risk of burning.
- In places with poor power supply conditions, take all steps necessary to ensure that the input power supply is within the specified voltage range.
There is a risk of device damage.
- Install breakers and other safety measure to provide protection against shorts in external wiring.
There is a risk of fire.
- Provide sufficient shielding when using the MP2300 in the following locations.
There is a risk of device damage.
 - Noise, such as from static electricity
 - Strong electromagnetic or magnetic fields
 - Radiation
 - Near to power lines
- When connecting the battery, connect the polarity correctly.
There is a risk of battery damage or explosion.
- Only qualified safety-trained personnel should replace the battery.
If the battery is replaced incorrectly, machine malfunction or damage, electric shock, or injury may result.
- When replacing the battery, do not touch the electrodes.
Static electricity may damage the electrodes.

■ Selecting, Separating, and Laying External Cables

⚠ CAUTION

- Consider the following items when selecting the I/O signal lines (external cables) to connect the MP2300 to external devices.
 - Mechanical strength
 - Noise interference
 - Wiring distance
 - Signal voltage, etc.
- Separate the I/O signal lines from the power lines both inside and outside the control box to reduce the influence of noise from the power lines.
If the I/O signal lines and power lines are not separated properly, malfunctioning may result.

Example of Separated External Cables

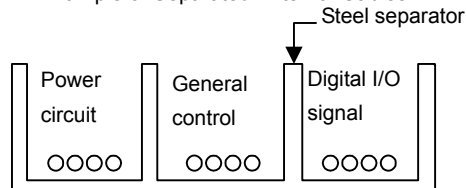

■ Maintenance and Inspection Precautions

CAUTION

- Do not attempt to disassemble the MP2300.
There is a risk of electrical shock or injury.
- Do not change wiring while power is being supplied.
There is a risk of electrical shock or injury.
- When replacing the MP2300, restart operation only after transferring the programs and parameters from the old Module to the new Module.
There is a risk of device damage.

■ Disposal Precautions

CAUTION

- Dispose of the MP2300 as general industrial waste.

■ General Precautions

Observe the following general precautions to ensure safe application.

- The products shown in illustrations in this manual are sometimes shown without covers or protective guards. Always replace the cover or protective guard as specified first, and then operate the products in accordance with the manual.
- The drawings presented in this manual are typical examples and may not match the product you received.
- If the manual must be ordered due to loss or damage, inform your nearest Yaskawa representative or one of the offices listed on the back of this manual.

Warranty

(1) Details of Warranty

■ Warranty Period

The warranty period for a product that was purchased (hereafter called “delivered product”) is one year from the time of delivery to the location specified by the customer or 18 months from the time of shipment from the Yaskawa factory, whichever is sooner.

■ Warranty Scope

Yaskawa shall replace or repair a defective product free of charge if a defect attributable to Yaskawa occurs during the warranty period above. This warranty does not cover defects caused by the delivered product reaching the end of its service life and replacement of parts that require replacement or that have a limited service life.

This warranty does not cover failures that result from any of the following causes.

1. Improper handling, abuse, or use in unsuitable conditions or in environments not described in product catalogs or manuals, or in any separately agreed-upon specifications
2. Causes not attributable to the delivered product itself
3. Modifications or repairs not performed by Yaskawa
4. Abuse of the delivered product in a manner in which it was not originally intended
5. Causes that were not foreseeable with the scientific and technological understanding at the time of shipment from Yaskawa
6. Events for which Yaskawa is not responsible, such as natural or human-made disasters

(2) Limitations of Liability

1. Yaskawa shall in no event be responsible for any damage or loss of opportunity to the customer that arises due to failure of the delivered product.
2. Yaskawa shall not be responsible for any programs (including parameter settings) or the results of program execution of the programs provided by the user or by a third party for use with programmable Yaskawa products.
3. The information described in product catalogs or manuals is provided for the purpose of the customer purchasing the appropriate product for the intended application. The use thereof does not guarantee that there are no infringements of intellectual property rights or other proprietary rights of Yaskawa or third parties, nor does it construe a license.
4. Yaskawa shall not be responsible for any damage arising from infringements of intellectual property rights or other proprietary rights of third parties as a result of using the information described in catalogs or manuals.

(3) Suitability for Use

1. It is the customer's responsibility to confirm conformity with any standards, codes, or regulations that apply if the Yaskawa product is used in combination with any other products.
2. The customer must confirm that the Yaskawa product is suitable for the systems, machines, and equipment used by the customer.
3. Consult with Yaskawa to determine whether use in the following applications is acceptable. If use in the application is acceptable, use the product with extra allowance in ratings and specifications, and provide safety measures to minimize hazards in the event of failure.
 - Outdoor use, use involving potential chemical contamination or electrical interference, or use in conditions or environments not described in product catalogs or manuals
 - Nuclear energy control systems, combustion systems, railroad systems, aviation systems, vehicle systems, medical equipment, amusement machines, and installations subject to separate industry or government regulations
 - Systems, machines, and equipment that may present a risk to life or property
 - Systems that require a high degree of reliability, such as systems that supply gas, water, or electricity, or systems that operate continuously 24 hours a day
 - Other systems that require a similar high degree of safety
4. Never use the product for an application involving serious risk to life or property without first ensuring that the system is designed to secure the required level of safety with risk warnings and redundancy, and that the Yaskawa product is properly rated and installed.
5. The circuit examples and other application examples described in product catalogs and manuals are for reference. Check the functionality and safety of the actual devices and equipment to be used before using the product.
6. Read and understand all use prohibitions and precautions, and operate the Yaskawa product correctly to prevent accidental harm to third parties.

(4) Specifications Change

The names, specifications, appearance, and accessories of products in product catalogs and manuals may be changed at any time based on improvements and other reasons. The next editions of the revised catalogs or manuals will be published with updated code numbers. Consult with your Yaskawa representative to confirm the actual specifications before purchasing a product.

Contents

Using this Manual	-iii
Safety Information	vi
Safety Precautions	vii
Warranty	xi
1 Overview of the MP2300	
1.1 Features	1-2
1.2 MP2300 Configuration	1-3
1.2.1 Basic Module Appearance	1-3
1.2.2 MP2300 Series Models	1-4
1.2.3 MP2300 Modules	1-5
1.3 System Configuration Example	1-6
1.4 Devices Connectable to MECHATROLINK	1-7
1.4.1 SERVOPACKs	1-7
1.4.2 Modules	1-7
1.5 Cables and Accessories	1-8
1.5.1 Cables	1-8
1.5.2 Accessories and Optionals	1-9
1.5.3 Software (Programming Tool (Optional))	1-9
2 Module Specifications	
2.1 MP2300 Basic Module Specifications	2-2
2.1.1 Hardware Specifications	2-2
2.1.2 Environmental Conditions	2-3
2.1.3 Function Specifications	2-4
2.2 MP2300 Basic Module Functions	2-7
2.2.1 External Appearance, LED Indicators, and Switch Settings	2-7
2.2.2 Module Configuration Definitions	2-9
2.2.3 CPU I/O (Built-in I/O) Module	2-11
2.2.4 Built-in SVB Modules	2-13
2.2.5 Setting SVB Module	2-17
2.2.6 Built-in SVB Specifications	2-25
2.2.7 SVR Virtual Motion Module	2-26
3 Mounting and Connections	
3.1 Mounting the MP2300	3-2
3.1.1 Basic Module Dimensional Drawings	3-2
3.1.2 Mounting the MP2300	3-3
3.1.3 Replacing and Adding Optional Modules	3-6

3.2 Basic Module Connections Specifications	3-9
3.2.1 Connectors	3-9
3.2.2 Power Supply Connector	3-10
3.2.3 MECHATROLINK Connectors	3-12
3.2.4 CPU I/O (Built-in I/O) Connectors	3-16
4 System Startup and Sample Programs	
4.1 Model System Startup Procedure	4-2
4.1.1 Flowchart for Model System Startup	4-2
4.1.2 System Configuration	4-3
4.1.3 Initializing SERVOPACKs	4-5
4.1.4 Setting and Saving Communication Process (Communication Manager)	4-6
4.1.5 MP2300 Self-configuration	4-12
4.2 Starting the Sample Program - MPE720 Ver 6.□□	4-13
4.2.1 Copying and Transferring Sample Program Files	4-13
4.2.2 Setting Motion Fixed Parameters and Adjusting the Settings for Servo Control	4-17
4.2.3 Saving Data from the MP2300 to Flash Memory, and Transferring Data to Your Computer from the MP2300	4-21
4.3 Starting Sample Program - MPE720 Ver 5.□□	4-23
4.3.1 Starting MPE720 Ver 5.□□ and Creating Folders	4-24
4.3.2 Reading Sample Programs and Setting and Saving Parameters	4-28
4.3.3 Other Operations	4-42
4.4 Checking Sample Program Operation	4-44
4.4.1 How to Open the Tuning Panel Window	4-44
4.4.2 Operation Check 1: Manual Operation	4-46
4.4.3 Operation Check 2: Position Control	4-53
4.4.4 Operation Check 3: Phase Control - Electronic Shaft	4-58
4.4.5 Operation Check 4: Phase Control - Electronic Cam	4-62
4.5 System Startup Using Self-Configuration	4-68
4.5.1 Starting the System for First Time	4-68
4.5.2 System Startup when Adding Electronic Devices	4-71
4.5.3 System Startup when Replacing Electronic Devices	4-73
5 Outline of Motion Control Systems	
5.1 Startup Sequence and Basic Operation	5-2
5.1.1 DIP Switch Settings	5-2
5.1.2 Startup Sequence	5-3
5.1.3 Startup Sequence Operation Details	5-4
5.1.4 LED Indicator Details	5-5

5.2	User Programs	5-6
5.2.1	Ladder Drawings (DWG)	5-6
5.2.2	Execution Control of Drawings	5-7
5.2.3	Motion Programs	5-10
5.2.4	Motion Programs and MSEE and S Registers	5-12
5.2.5	Example of Ladder Programs for Motion Program Control	5-18
5.2.6	Functions	5-20
5.3	Registers	5-21
5.3.1	Types of Registers	5-21
5.3.2	Data Types and Register Specifications	5-24
5.3.3	Using i and j Subscripts	5-26
5.3.4	Register Specification Methods	5-27
5.4	Self-configuration	5-28
5.4.1	Self-configuration Processing Procedure	5-29
5.4.2	Execution Procedure for Self-configuration Using the DIP Switch	5-30
5.4.3	Execution Procedure for Self-configuration Using MPE720	5-32
5.4.4	Definition Data Refreshed by Self-configuration	5-36
5.5	Precautions When Using the MP2300	5-38
5.5.1	Precautions when Setting or Changing User Definition Files	5-38
5.5.2	Precautions when Setting or Changing Module Configuration Definition Files	5-39
5.5.3	Setting and Changing the Scan Time	5-40
6	Maintenance and Inspection	
6.1	Inspection Items	6-2
6.1.1	Daily Inspections	6-2
6.1.2	Regular Inspections	6-3
6.2	Replacing the Basic Module Battery	6-4
6.2.1	Procedure	6-4
6.3	Troubleshooting	6-5
6.3.1	Basic Flow of Troubleshooting	6-5
6.3.2	MP2300 Error Check Flowchart	6-6
6.3.3	LED Indicators	6-7
6.4	Troubleshooting System Errors	6-9
6.4.1	Outline of System Registers	6-9
6.4.2	Accessing System Registers	6-10
6.4.3	Troubleshooting When ERR is Lit	6-12
6.4.4	Troubleshooting When ALM is Lit	6-13
6.4.5	System Register Configuration and Error Status	6-14
6.5	Motion Program Alarms	6-24
6.5.1	Motion Program Alarm Configuration	6-24
6.5.2	Motion Program Alarm Code List	6-24
6.6	List of Causes for Command Error Occurrence	6-26

6.7 Troubleshooting Motion Errors	6-30
6.7.1 Overview of Motion Errors	6-30
6.7.2 Motion Error Details and Corrections	6-31
6.7.3 Servo Driver Status and Servo Driver Error Codes	6-36

Appendices

A System Registers Lists	A-2
A.1 System Service Registers	A-2
A.2 Scan Execution Status and Calendar	A-4
A.3 Program Software Numbers and Remaining Program Memory Capacity Name	A-4
B Current Values and Set Values (Input Data) in the SVB Definition Window	A-5
B.1 Operations and Parameter Data Flow	A-5
B.2 Precautions When Saving SERVOPACK Parameters	A-12
C Initializing the Absolute Encoder	A-13
C.1 Initializing Procedures for Σ -V and Σ -III Series SERVOPACKs	A-13
C.2 Σ -II SERVOPACK	A-15
C.3 Σ -I SERVOPACK	A-17
D Motion Parameter Lists	A-19
D.1 Fixed Parameter List	A-19
D.2 Setting Parameter List	A-20
D.3 Monitoring Parameter List	A-25

INDEX

Revision History

Overview of the MP2300

This chapter explains an overview and features of the MP2300 Machine Controller.

1.1 Features	1-2
1.2 MP2300 Configuration	1-3
1.2.1 Basic Module Appearance	1-3
1.2.2 MP2300 Series Models	1-4
1.2.3 MP2300 Modules	1-5
1.3 System Configuration Example	1-6
1.4 Devices Connectable to MECHATROLINK	1-7
1.4.1 SERVOPACKs	1-7
1.4.2 Modules	1-7
1.5 Cables and Accessories	1-8
1.5.1 Cables	1-8
1.5.2 Accessories and Optionals	1-9
1.5.3 Software (Programming Tool (Optional))	1-9

1.1 Features

The MP2300 is an all-in-one, compact Machine Controller that combines power supply, CPU, SVB, I/O, and communication functions in one system. The MP2300 consists of a Basic Module that performs motion control and sequence control and Optional Modules that perform I/O and communication functions.

The MP2300 has the following features:

- Flexibility
- High performance, and
- Easy to use

■ Flexibility

Optional Modules can be inserted into any of the three slots, so the optimum system can be built for your machine.

■ High Performance

- High control characteristics have been realized by increasing the CPU and Motion Network (MECHATROLINK-II) speed.
 - MECHATROLINK-II baud rate: 2.5 times faster
 - CPU processing speed: 1.4 times faster than MP930
- MECHATROLINK-II enables position control, speed control, and torque control and makes precise synchronous control possible. The control mode can also be changed while online, facilitating complicated machine operations.
- Select the appropriate Communication Module to use the following open networks.
 - Ethernet
 - DeviceNet
 - PROFIBUS
 - MPLINK
 - CP-215

■ Easy to Use

- The time of machine development can be greatly reduced by using the self-configuration function that automatically detects devices connected to MECHATROLINK and automatically sets the required parameters.
- The application program converter can utilize your previous software assets with their accumulated databanks of specific knowledge to improve the system further.

1.2 MP2300 Configuration

The MP2300 is configured with one Basic Module and up to three Optional Modules.

1.2.1 Basic Module Appearance

The following figure shows the external appearance of the Basic Module.

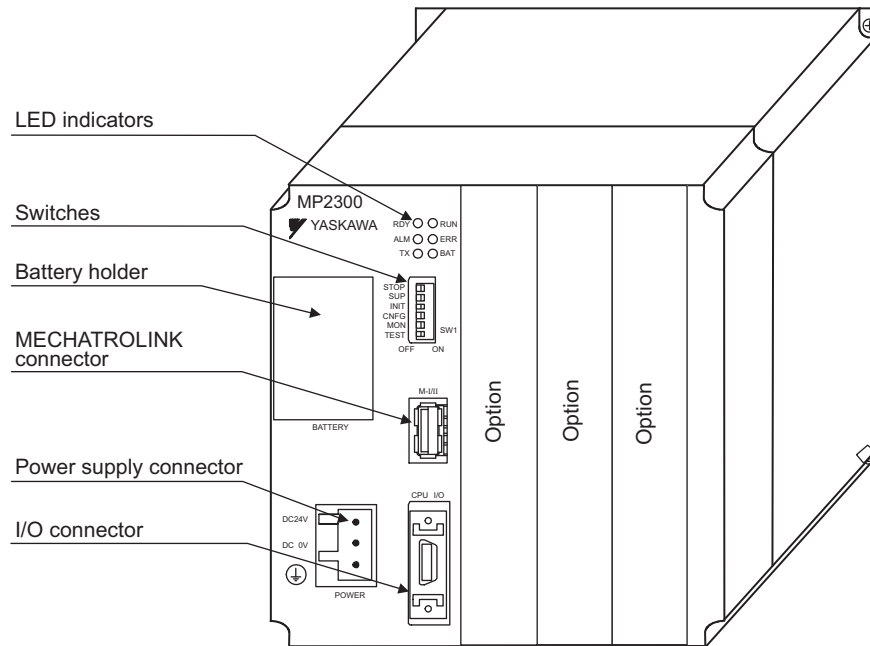

1.2.2 MP2300 Series Models

The following table shows the possible combinations of the MP2300 Basic Module with the PS, the CPU, and the MB, and Optional Modules.

No.	Model	Combination of Modules				
1	JEPMC-MP2300	<table border="1"> <tr> <td>Basic Module</td> <td></td> <td></td> <td></td> </tr> </table>	Basic Module			
Basic Module						
2	JEPMC-MP2300-Y1	<table border="1"> <tr> <td>Basic Module</td> <td>217 IF</td> <td>218 IF</td> <td>LIO 01</td> </tr> </table>	Basic Module	217 IF	218 IF	LIO 01
Basic Module	217 IF	218 IF	LIO 01			
3	JEPMC-MP2300-Y2	<table border="1"> <tr> <td>Basic Module</td> <td>218 IF</td> <td>LIO 01</td> <td>LIO 01</td> </tr> </table>	Basic Module	218 IF	LIO 01	LIO 01
Basic Module	218 IF	LIO 01	LIO 01			
4		Reserved				
5	JEPMC-MP2300-Y4	<table border="1"> <tr> <td>Basic Module</td> <td>217 IF</td> <td>218 IF</td> <td>LIO 02</td> </tr> </table>	Basic Module	217 IF	218 IF	LIO 02
Basic Module	217 IF	218 IF	LIO 02			
6	JEPMC-MP2300-Y5	<table border="1"> <tr> <td>Basic Module</td> <td>218 IF</td> <td>LIO 02</td> <td>LIO 02</td> </tr> </table>	Basic Module	218 IF	LIO 02	LIO 02
Basic Module	218 IF	LIO 02	LIO 02			
7		Reserved				
8	JEPMC-MP2300-Y7	<table border="1"> <tr> <td>Basic Module</td> <td>217 IF</td> <td>217 IF</td> <td>LIO 01</td> </tr> </table>	Basic Module	217 IF	217 IF	LIO 01
Basic Module	217 IF	217 IF	LIO 01			
9	JEPMC-MP2300-Y8	<table border="1"> <tr> <td>Basic Module</td> <td>217 IF</td> <td>LIO 01</td> <td>LIO 01</td> </tr> </table>	Basic Module	217 IF	LIO 01	LIO 01
Basic Module	217 IF	LIO 01	LIO 01			
10		Reserved				
11	JEPMC-MP2300-Y10	<table border="1"> <tr> <td>Basic Module</td> <td>217 IF</td> <td>217 IF</td> <td>LIO 02</td> </tr> </table>	Basic Module	217 IF	217 IF	LIO 02
Basic Module	217 IF	217 IF	LIO 02			

(cont'd)

No.	Model	Combination of Modules			
12	JEPMC-MP2300-Y11	Basic Module	217 IF	LIO 01	LIO 02

1.2.3 MP2300 Modules

The following table shows the names and descriptions of the Basic Module and Optional Modules.

Group	Name	Description	Model	Remarks	
Basic Module	Basic Module	MP2300	JAPMC-MP2300	MECHATROLINK-I, MECHATROLINK-II 8 input, 4 outputs	
Optional Modules	Motion Modules	MECHATROLINK-II Motion-control Module	SVB-01	JAPMC-MC2310	MECHATROLINK-I, -II, 16 axes maximum
		Analog Output Motion-control Module	SVA-01	JAPMC-MC2300	Analog output, 2 axes maximum
		Pulse Output Motion-control Module	PO-01	JAPMC-PL2310-E	Pulse output, 4 axes maximum
	I/O Modules	I/O Module	LIO-01	JAPMC-IO2300	16 inputs, 16 outputs (sink mode output) 1 pulse input
		I/O Module	LIO-02	JAPMC-IO2301	16 inputs, 16 outputs (source mode output) 1 pulse input
		I/O Module	LIO-04	JAPMC-IO2303	32 inputs, 32 outputs (sink mode output)
		I/O Module	LIO-05	JAPMC-IO2304	32 inputs, 32 outputs (source mode output)
		Analog Input Module	AI-01	JAPMC-AN2300	Analog input, 8 channels
		Analog Output Module	AO-01	JAPMC-AN2310-E	Analog output, 4 channels
		Output Module	DO-01	JAPMC-DO2300	64 outputs (sink mode output)
	Communication Modules	Ethernet Communication Module	218IF-01	JAPMC-CM2300	RS-232C and 10Base-T Ethernet communication
			218IF-02	JAPMC-CM2302-E	RS-232C and 100Base-TX/10Base-T Ethernet communication
		General-purpose Serial Communication Module	217IF-01	JAPMC-CM2310	RS-232C and RS422/485 communication
		DeviceNet Communication Module	260IF-01	JAPMC-CM2320	RS-232C and DeviceNet communication
		PROFIBUS Communication Module	261IF-01	JAPMC-CM2330	RS-232C and PROFIBUS communication
MPLINK Communication Module		215AIF-01 MPLINK	JAPMC-CM2360	RS-232C and MPLINK communication	
CP-215 Communication Module		215AIF-01 CP-215	JAPMC-CM2361	RS-232C and CP-215 communication	

1.3 System Configuration Example

The following diagram shows an example of system configuration.

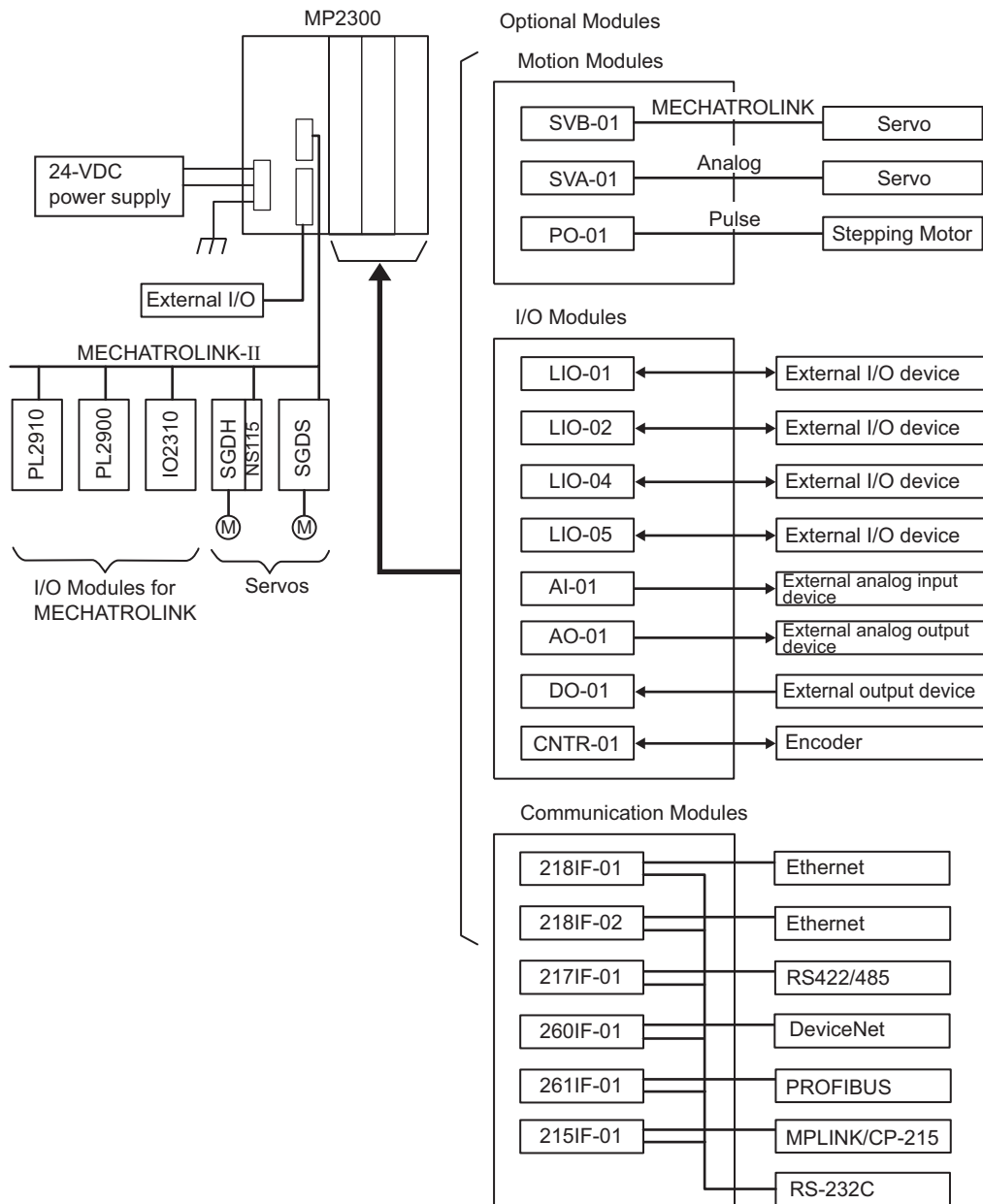

- For the details on the system configuration example, refer to *4.1.2 System Configuration* on page 4-3.
- Use the connecting cables and connectors recommended by Yaskawa. Always check the device to be used and select the correct cable for the device.
- Different SERVOPACKs are connected to MECHATROLINK-I (4 Mbps) and MECHATROLINK-II (10 Mbps). Refer to *1.4.1 SERVOPACKs* on page 1-7 and select the appropriate SERVOPACKs.
- If devices compatible with MECHATROLINK-I and with MECHATROLINK-II are used together, make the settings for MECHATROLINK-I.
- The user must supply the 24-VDC power supply.
- When connecting SERVOPACKs via MECHATROLINK, connect the overtravel, zero point return deceleration limit switch, and external latch signals to the SERVOPACKs. For connection, refer to the SERVOPACK's manual.

1.4 Devices Connectable to MECHATROLINK

The devices that are compatible with MECHATROLINK and can be connected to the MP2300 and the SVB-01 Module are listed below.

1.4.1 SERVOPACKs

Model Number	Details	MECHATROLINK-I	MECHATROLINK-II
SGDV-□□□□11 SGDV-□□□□15	MECHATROLINK-II communications reference compatible SERVOPACKs	Yes	Yes
SGDS-□□□1□□	SGDS SERVOPACK	Yes	Yes
SGDH-□□□E JUSP-NS115	SGDH SERVOPACK NS115 MECHATROLINK-II Interface Unit	Yes	Yes
SGDH-□□□E JUSP-NS100	SGDH SERVOPACK NS110 MECHATROLINK-I Interface Units	Yes	No
SGD-□□□N SGDB-□□AN	MECHATROLINK compatible AC SERVO- PACKs	Yes	No

1.4.2 Modules

Model Number	Details	MECHATROLINK-I	MECHATROLINK-II
JEPMC-IO2310	64-point I/O Module 24 VDC, 64 inputs, 64 outputs (sink mode output)	Yes	Yes
JEPMC-IO2330	64-point I/O Module 24 VDC, 64 inputs, 64 outputs (source mode output)	Yes	Yes
JEPMC-PL2900	Counter Module Reversible counter, 2 channels	Yes	Yes
JEPMC-PL2910	Pulse Output Module Pulse output, 2 channels	Yes	Yes
JEPMC-AN2900	A/D Module Analog inputs, -10 to 10 V, 4 channels	Yes	Yes
JEPMC-AN2910	D/A Module Analog outputs, -10 to 10 V, 2 channels	Yes	Yes
JEPMC-IO350	64-point I/O Module 24 VDC, 64 inputs, 64 outputs	Yes	No
JAMSC-120DDI34330	DC Input Module 12/24 VDC, 16 inputs	Yes	No
JAMSC-120DDO34340	DC Output Module 12/24 VDC, 16 outputs	Yes	No
JAMSC-120DAI53330	AC Input Module 100 VAC, 8 inputs	Yes	No
JAMSC-120DAI73330	AC Input Module 200 VAC, 8 inputs	Yes	No
JAMSC-120DAO83330	AC Output Module 100/200 VAC, 8 outputs	Yes	No
JAMSC-120DRA83030	Relay Module Wide voltage range relay contacts, 8 contact outputs	Yes	No
JAMSC-120AVI02030	A/D Module Analog inputs, -10 to 10 V, 4 channels	Yes	No
JAMSC-120AVO01030	D/A Module Analog outputs, -10 to 10 V, 2 channels	Yes	No
JAMSC-120EHC21140	Counter Module Reversible counter, 2 channels	Yes	No
JAMSC-120MMB20230	Pulse Output Module Pulse output, 2 channels	Yes	No
JEPMC-REP2000	MECHATROLINK-II Repeater	No	Yes
JEVSA-YV250	MYVIS (image processing device)	Yes	Yes

- For details on each Module, refer to the *Machine Controller MP900/MP2000 Series MECHATROLINK System User's Manual* (Manual No.: SIE-C877-5.1).

1.5 Cables and Accessories

1.5.1 Cables

The following table shows the cables that can be connected to the MP2300 Basic Module and Optional Modules.

Module	Connector Name	Application	Model	Specifications
MP2300 Basic Module and SVB-01	CPU I/O	External I/O	JEPMC-W2060-□□	Used between CPU I/O and External I/O device
	M-I/II	MECHATROLINK-I cable	JEPMC-W6010-□□ *with a MECHATROLINK connector and loose wires	Used between the devices listed below SVB-01 and SGD-□□□N SVB-01 and SGDB-□□AN
		MECHATROLINK-I Terminator	JEPMC-W6020	
		MECHATROLINK-II cable	JEPMC-W6002-□□ *with MECHATROLINK connectors on both ends	Used between the devices listed below SVB-01 and I/O Unit, SVB-01 and SGDH-□□E+NS100 SVB-01 and SGDH-□□E+NS115 SVB-01 and SGDS-□□□1□□ SVB-01 and SGD-□□□□11 SVB-01 and SGD-□□□□15
			JEPMC-W6003-□□ *with MECHATROLINK connectors on both ends *with ferrite core	
MECHATROLINK-II Terminator	JEPMC-W6022			
SVA-01	CN/1 CN/2	Cable for analog reference input SERVOPACK	JEPMC-W2040-□□	Used between the devices listed below SVA-01 and SGDM/SGDH SVA-01 and SGDS-□□□01□ SVA-01 and SGDS-□□□02□ SVA-01 and SGD-□□□□01 SVA-01 and SGD-□□□□05
PO-01	CN/1, CN/2	Pulse I/O	JEPMC-W6060-□□ *Loose wires on one end	Used between PO-01 and Stepping motor
LIO-01 LIO-02	I/O	External I/O	JEPMC-W2061-□□ *Loose wires on one end	Used between LIO-01/02 and External I/O device
LIO-04 LIO-05	CN/1, CN/2	External I/O	JEPMC-W6060-□□ *Loose wires on one end	Used between LIO-04/05 and External I/O device
AI-01	CN/1, CN/2	Analog external inputs	JEPMC-W6080-□□ *Loose wires on one end	Used between AI-01 and Analog external output device
AO-01	CN/1, CN/2	Analog external outputs	JEPMC-W6090-□□ *Loose wires on one end	Used between AO-01 and Analog external input device
DO-01	CN/1, CN/2	External outputs	JEPMC-W6060-□□ *Loose wires on one end	Used between DO-01 and External I/O device
CNTR-01	CN/1	External I/O	JEPMC-W2063-□□ *Loose wires on one end	Used between CNTR-01 and Encoder
Common to all communication modules	PORT	RS-232C communication cable	JEPMC-W5310-□□	Used between RS-232C port and 25-pin male D-sub connector
			JEPMC-W5311-□□	Used between RS-232C port and DOS/V

(cont'd)

Module	Connector Name	Application	Model	Specifications
218IF-01	10Base-T	Ethernet communication cable	Use a commercially available cable.	10Base-T Cross or Straight cable (Category 3 min.)
218IF-02	Ethernet	Ethernet communication cable		100Base-TX Cross or Straight cable (Category 3 min.)
217IF-01	RS422/485	RS422/485 communication cable		Module-side connector: 1010214-52A2JL (manufactured by Sumitomo 3M) Cable-side connector: 10114-3000VE (manufactured by Sumitomo 3M) Shell: 10314-52A0-008 (manufactured by Sumitomo 3M)
260IF-01	DeviceNet	DeviceNet communication cable		Module-side connector: MSTB2-5/5-GF-5.08AM (manufactured by Phoenix Contact K.K.)
261IF-01	PROFIBUS	PROFIBUS communication cable		Module-side connector: 17LE-13090-27(D33C) (manufactured by DDK Ltd.)
215AIF-01	MPLINK	MPLINK communication cable (MECHATROLINK cable)	JEPMC-W6002-□□ *with MECHATROLINK connectors on both ends	Used between 215AI-01 MPLINK and MPLINK compatible device
			JEPMC-W6003-□□ *with MECHATROLINK connectors on both ends *with ferrite core	
	CP-215	CP-215 communication cable	JEPMC-W6022	Terminator
			Provided by the customers. Refer to the communication module manual (Manual No.: SIEPC88070004).	

1.5.2 Accessories and Optionals

Name	Accessory/Optional	Model	Remarks
Battery	Accessory	JZSP-BA01	ER3VC + exclusive use connector (BA000517)
Power Supply Connector	Accessory	721-203/026	Cable side
DIN Rail Mounting Parts	Optional	JEPMC-OP300	2 parts for 1 set
Option Slot Cover	Optional	JEPMC-OP2300	Front cover for empty slot

1.5.3 Software (Programming Tool (Optional))

The MPE720, programming tool for MP2300, is available.

Name	Model	Remarks
MPE720	CPMC-MPE720 (Ver 4.41A or later)	CD-ROM (1 disk)
MPE720 Ver. 6	CPMC-MPE770	CD-ROM (1 disk)

Module Specifications

This chapter explains detailed specifications and functions for the Basic Module of the MP2300.

2.1 MP2300 Basic Module Specifications	2-2
2.1.1 Hardware Specifications	2-2
2.1.2 Environmental Conditions	2-3
2.1.3 Function Specifications	2-4
2.2 MP2300 Basic Module Functions	2-7
2.2.1 External Appearance, LED Indicators, and Switch Settings	2-7
2.2.2 Module Configuration Definitions	2-9
2.2.3 CPU I/O (Built-in I/O) Module	2-11
2.2.4 Built-in SVB Modules	2-13
2.2.5 Setting SVB Module	2-17
2.2.6 Built-in SVB Specifications	2-25
2.2.7 SVR Virtual Motion Module	2-26

2.1 MP2300 Basic Module Specifications

This section describes the Basic Module Specifications of the MP2300.

2.1.1 Hardware Specifications

The following table shows the hardware specifications of the Basic Module.

Item	Specifications
Classification	Basic Module
Name	MP2300
Model Number	JEPMC-MP2300
Flash Memory	8 MBytes (User area 5.5 MBytes)
SDRAM	16 MBytes
SRAM	256 kBytes: M registers, S registers, trace memory, alarm history (battery backup)
Motion Network MECHATROLINK	Motion network 1 channel SERVOPACK and I/O for up to 21 stations connectable (SERVOPACK for up to 16 axes) Baud rate: 4 Mbps (MECHATROLINK-I) or 10 Mbps (MECHATROLINK-II)
I/O Signal	8 digital inputs (1 input also used as an interrupt input) 24 VDC, 4.1 mA (TYP) source mode/sink mode inputs 4 digital outputs 24 VDC, 100 mA (TYP) open-collector sink mode outputs
Calendar	Seconds to year timer (Battery backup)
Connectors	POWER: Power supply connector M-I/II: MECHATROLINK connector CPU I/O: I/O connector
Indicators	RDY (green) RUN (green) ALM (red) ERR (red) TX (green) BAT (red)
Switches	STOP SUP INIT CNFG MON TEST
Current Consumption	1A max.
Dimensions (mm)	120 × 130 × 105 (W × H × D)
Mass	450 g

2.1.2 Environmental Conditions

Item		Specifications
Environmental Conditions	Ambient Operating Temperature	0°C to 55°C
	Ambient Storage Temperature	-25°C to 85°C
	Ambient Operating Humidity	30% to 95% (with no condensation)
	Ambient Storage Humidity	5% to 95% (with no condensation)
	Pollution Level	Pollution level 1 (conforming to JIS B 3501)
	Corrosive Gas	There must be no combustible or corrosive gas.
	Operating Altitude	2,000 m above sea level or lower
Mechanical Operating Conditions	Vibration Resistance	Conforming to JIS B 3502: <ul style="list-style-type: none"> • 10 to 57 Hz with single-amplitude of 0.075 mm • 57 to 150 Hz with fixed acceleration of 9.8 m/s² • 10 sweeps each in X, Y, and Z directions (sweep time: 1 octave/min)
	Shock Resistance	Conforming to JIS B 3502: Peak acceleration of 147 m/s ² (15 G) twice for 11 ms each in the X, Y, and Z directions
Electrical Operating Conditions	Noise Resistance	Conforming to EN 61000-6-2, EN 55011 (Group 1, Class A) Power supply noise (FT noise): 2 Kv min., for one minute Radiation noise (FT noise): 1 Kv min., for one minute
Installation Requirements	Ground	Ground to 100 Ω max.
	Cooling Method	Natural cooling

2.1.3 Function Specifications

(1) PLC Function Specifications

The following table shows the PLC function specifications.

Item	Specifications
Control Method	Sequence: High-speed and low-speed scan methods
Programming Language	Ladder diagram: Relay circuit Text-type language: Numeric operations, logic operations, etc.
Scanning	Two scan levels: High-speed scan and low-speed scan High-speed scan time setting: 1 to 32 ms (Integral multiple of MECHATROLINK communication cycle) Low-speed scan time setting: 2 to 300 ms (Integral multiple of MECHATROLINK communication cycle)
User Drawings, Functions and Motion Programs	Startup drawings (DWGA): 64 drawings max. Up to three hierarchical drawing levels Interrupt processing drawings (DWGI): 64 drawings max. Up to three hierarchical drawing levels High-speed scan process drawings (DWGH): 200 drawings max. Up to three hierarchical drawing levels Low-speed scan process drawings (DWGL): 500 drawings max. Up to three hierarchical drawing levels Number of steps: Up to 1,000 steps per drawing User functions: Up to 500 functions Motion programs: Up to 256 Revision history of drawings and motion programs Security function for drawings and motion programs
Data Memory	Common data (M) registers: 64 Kwords System (S) registers: 8 Kwords Drawing local (D) registers: Up to 16 Kwords per drawing Drawing constant (#) registers: Up to 16 Kwords per drawing Input (I) registers: 32 Kwords (including internal input registers) Output (O) registers: 32 Kwords (including internal output registers) Constant (C) registers: 16 Kwords
Trace Memory	Data trace: 128 Kwords (32 Kwords × 4 groups), 16 points defined
Memory Backup	Program memory: Flash memory: 8 MBytes (User area: 5.5 MBytes) definition files, ladder programs, motion programs, etc. Data other than battery backup data Data memory: Battery backup: 256 Kbytes, M registers, S registers, alarm history, trace data
Data Types	Bit (relay): ON/OFF Integer: -32768 to +32767 Double-length integer: -2147483648 to +2147483647 Real number: ± (1.175E-38 to 3.402E+38)
Register Designation Method	Register number: Direct designation of register number Symbolic designation: Up to 8 alphanumeric characters (up to 200 symbols per drawing) With automatic number or symbol assignment
Instructions	Program control instructions: 14 instructions Direct I/O instructions: 2 instructions Relay circuit instructions: 14 instructions (including set and reset coils) Logic operation instructions: 3 instructions Numeric operation instructions: 16 instructions Numeric conversion instructions: 9 instructions Numeric comparison instructions: 7 instructions Data manipulation instructions: 14 instructions Basic function instructions: 10 instructions Table data manipulation instructions: 11 instructions DDC instructions: 13 instructions System functions: 9 instructions

(2) Motion Control Function Specifications

The following table lists the motion control function specifications for the MP2300.

Item		Specifications														
Interface		MECHATROLINK-I, MECHATROLINK-II														
Number of Controlled Axes/Module		Up to 16 axes (up to 48 axes when two SVB Modules are mounted)														
Control Specifications	PTP Control	Linear, rotary, and infinite-length														
	Interpolation	Up to 16 linear axes, 2 circular axes, and 3 helical axes														
	Speed Reference Output	Yes (Only with MECHATROLINK-II)														
	Torque Reference Output	Yes (Only with MECHATROLINK-II)														
	Phase Control	Yes (Only with MECHATROLINK-II)														
	Position Control	Positioning	Yes													
		External positioning	Yes													
		Zero point return	Yes													
		Interpolation	Yes													
		Interpolation with position detection function	Yes													
JOG operation		Yes														
STEP operation		Yes														
Parameter changes during motion command execution	Yes (Only with MECHATROLINK-II in 32-byte mode)															
Reference Unit		mm, inch, deg, pulse, or μm														
Reference Unit Minimum Setting		1, 0.1, 0.01, 0.001, 0.0001, 0.00001														
Maximum Programmable Value		-2147483648 to +2147483647 (signed 32-bit value)														
Speed Reference Unit		Reference unit/s designation: mm/s, inch/s, deg/s, pulse/s, $\mu\text{m/s}$ Reference unit/min. designation: mm/min, inch/min, deg/min, pulse/min, $\mu\text{m/min}$ Percentage designation: Percentage of rated speed														
Acceleration/Deceleration Type		Linear, asymmetric, S-curve, exponent														
Acceleration/Deceleration Reference Unit		Reference unit/s ² designation: mm/s ² , inch/s ² , deg/s ² , pulse/s ² , $\mu\text{m/s}^2$ Acceleration/deceleration time constant: Time from 0 to rated speed (ms)														
Override Function		Positioning: 0.01% to 327.67% by axis														
Coordinate System		Rectangular coordinates														
Zero Point Return		<table border="0"> <tr> <td>DEC1+ Phase-C pulse</td> <td>Home limit switch and Phase-C pulse</td> </tr> <tr> <td>ZERO signal</td> <td>HOME</td> </tr> <tr> <td>DEC1+ ZERO signal</td> <td>NOT and Phase-C pulse</td> </tr> <tr> <td>Phase-C pulse</td> <td>NOT</td> </tr> <tr> <td>Only Phase-C pulse</td> <td>INPUT and Phase-C pulse</td> </tr> <tr> <td>POT and Phase-C pulse</td> <td>INPUT</td> </tr> <tr> <td>POT</td> <td></td> </tr> </table>	DEC1+ Phase-C pulse	Home limit switch and Phase-C pulse	ZERO signal	HOME	DEC1+ ZERO signal	NOT and Phase-C pulse	Phase-C pulse	NOT	Only Phase-C pulse	INPUT and Phase-C pulse	POT and Phase-C pulse	INPUT	POT	
DEC1+ Phase-C pulse	Home limit switch and Phase-C pulse															
ZERO signal	HOME															
DEC1+ ZERO signal	NOT and Phase-C pulse															
Phase-C pulse	NOT															
Only Phase-C pulse	INPUT and Phase-C pulse															
POT and Phase-C pulse	INPUT															
POT																
Applicable SERVOPACKs		<table border="0"> <tr> <td> <ul style="list-style-type: none"> ■ MECHATROLINK-I • SERVOPACKs SGD-□□□N SGDB-□□AN SGDH-□□□E + NS100 SGDS-□□□1□□ SGDV-□□□□11 SGDV-□□□□15 • Inverter VS-616G5 (216IF card is needed) </td> <td> <ul style="list-style-type: none"> ■ MECHATROLINK-II • SERVOPACKs SGDH-□□□E + NS115 SGDS-□□□1□□ SGDV-□□□□11 SGDV-□□□□15 </td> </tr> </table>	<ul style="list-style-type: none"> ■ MECHATROLINK-I • SERVOPACKs SGD-□□□N SGDB-□□AN SGDH-□□□E + NS100 SGDS-□□□1□□ SGDV-□□□□11 SGDV-□□□□15 • Inverter VS-616G5 (216IF card is needed) 	<ul style="list-style-type: none"> ■ MECHATROLINK-II • SERVOPACKs SGDH-□□□E + NS115 SGDS-□□□1□□ SGDV-□□□□11 SGDV-□□□□15 												
<ul style="list-style-type: none"> ■ MECHATROLINK-I • SERVOPACKs SGD-□□□N SGDB-□□AN SGDH-□□□E + NS100 SGDS-□□□1□□ SGDV-□□□□11 SGDV-□□□□15 • Inverter VS-616G5 (216IF card is needed) 	<ul style="list-style-type: none"> ■ MECHATROLINK-II • SERVOPACKs SGDH-□□□E + NS115 SGDS-□□□1□□ SGDV-□□□□11 SGDV-□□□□15 															

2 Module Specifications

2.1.3 Function Specifications

(cont'd)

Item	Specifications
Encoders	<ul style="list-style-type: none">• Incremental Encoder• Yaskawa Absolute Encoder

2.2 MP2300 Basic Module Functions

MP2300 Basic Module is an all-in-one, compact module that combines power supply, CPU, built-in SVB, and I/O in one module. The Basic Module has both motion control and sequence control functions. With the 3-slot option slot configuration, Optional Modules can be selected freely and the optimum system can be built for your machine. An outline of the Basic Module functions is shown in the following diagram.

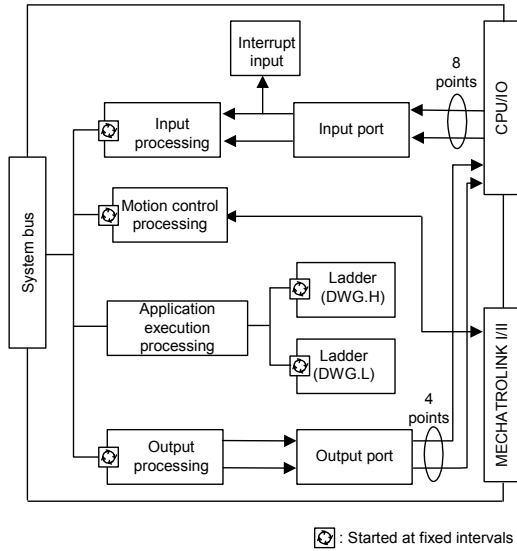

2.2.1 External Appearance, LED Indicators, and Switch Settings

(1) External Appearance

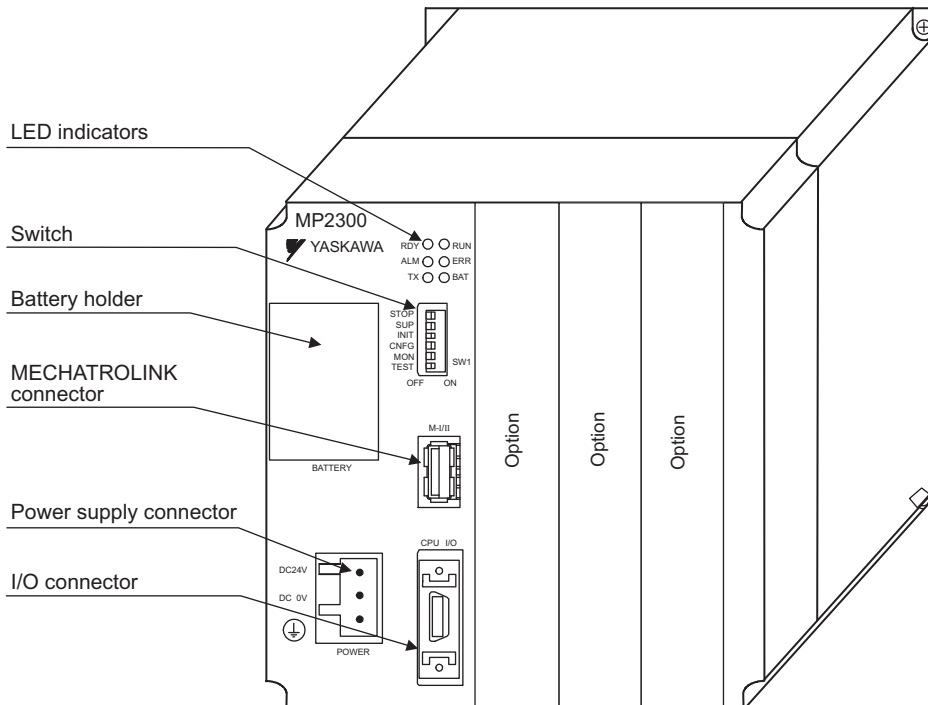

(2) Indicators

The following table shows the indicators that show the operating status of the Basic Module and error information.

	Indicator	Color	Status
RDY ○ ○ RUN ALM ○ ○ ERR TX ○ ○ BAT	RDY	Green	Lit during normal operation.
	RUN	Green	Lit during execution of user program.
	ALM	Red	Lit/blinking when warning occurs.
	ERR	Red	Lit/blinking when malfunction occurs.
	TX	Green	Lit during transmission of MECHATROLINK I/II data.
	BAT	Red	Lit during battery alarm.

- For details on indicator meanings, refer to 6.3.3 (2) LED Indicator Meanings on page 6-7.

(3) Switch Settings

The DIP switch sets the operating conditions for the Basic Module when the power is turned ON.

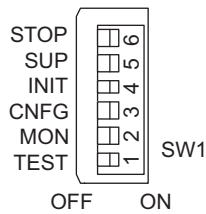

No.	Name	Setting	Operating Mode	Default Setting	Details
6	STOP	ON	User program stopped	OFF	Stops the user program execution. Enabled only when the power is turned ON.
		OFF	User program running		
5	SUP	ON	System use	OFF	Always leave set to OFF.
		OFF	Normal operation		
4	INIT	ON	Memory clear	OFF	Set to ON to clear the memory. If this switch is set to OFF, the program stored in flash memory will be executed.
		OFF	Normal operation		
3	CNFG	ON	Configuration mode	OFF	Set to ON to execute self-configuration for connected devices.
		OFF	Normal operation		
2	MON	ON	System use	OFF	Always leave set to OFF.
		OFF	Normal operation		
1	TEST	ON	System use	OFF	Always leave set to OFF.
		OFF	Normal operation		

2.2.2 Module Configuration Definitions

Configuration of the MP2300 including Basic Module and Optional Modules can be obtained and modified in the **Module Configuration** Window.

(1) Module Configuration Window Components

A typical MP2300 Module Configuration Window is shown below.

The screenshot shows the 'Module Configuration' window for 'MF 2300 Online Local'. It is divided into two main sections: 'Controller' and 'Module Details'. Annotations point to specific configuration items:

- Information on Basic Module:** Points to the 'Controller' table, specifically the 'Module Type' (MP2300) and 'Status' (Running).
- Information on the mounted Optional Modules:** Points to the 'Module Details' table, specifically the 'Module Type' (CPU, IO, SVB, SVR) and 'Status' (Running).
- Configuration of the Basic Module CPU:** Points to the 'CPU' module type in the 'Module Details' table.
- Configuration of the CPU I/O Module built in the Basic Module:** Points to the 'IO' module type in the 'Module Details' table.
- Configuration of the SVB Module built in the Basic Module:** Points to the 'SVB' module type in the 'Module Details' table.
- Configuration of the SVR Virtual Motion Module built in the Basic Module:** Points to the 'SVR' module type in the 'Module Details' table.

- For information on how to open the Module Configuration Window, refer to 4.3.2 (4) *Set and Save Motion Fixed Parameters* on page 4-36.

The following table lists the items shown in the Module Configuration Window.

Item	Description	Modification
Slot Number	Slot number	Not possible
Module Type	Module detected in the slot	Possible
Controller Number	Fixed to 01	Not possible
Circuit Number	Module circuit number	Possible
I/O Start Register	I/O start register number of the I/O Module to be connected to MECHATROLINK	Possible
I/O End Register	I/O last register number of the I/O Module to be connected to MECHATROLINK	Possible
Disable Input	Input enabled (Enable)/disabled (Disable)	Possible (Not possible if the cell is blank)
Disable Output	Output enabled (Enable)/disabled (Disable)	Possible (Not possible if the cell is blank)
Motion Start Register	Start register number of the motion parameters (Automatically sets according to the circuit number)	Not possible

Motion End Register	Last register number of the motion parameters (Automatically sets according to the circuit number)	Not possible
Details	Opens the MECHATROLINK Transmission Definition Window. (Double-click the MECHATROLINK cell of SVB Module to open the window.)	–
Status	Status of each module in online mode	Not possible

- “Possible” in the Modification line in the above table means that it is possible to change the setting of the item. Always save the setting to the flash memory after having changed the setting.
- When changing the setting, be careful not to set the register numbers overlapped with another module.
- I/O Start Register and I/O End Register must be set even though the I/O Module is connected or not connected to MECHATROLINK.

(2) Self-Configuration

The self-configuration function automatically recognizes the Optional Modules mounted on the Machine Controller, creates definition files such as the module configuration definition file, MECHATROLINK transmission definition file, and SVB definition file. Additionally, module definition data can be automatically refreshed by executing the self-configuration function when starting the MP2300 or anytime thereafter.

- For information on how to execute the self-configuration function, refer to *5.4.2 Execution Procedure for Self-configuration Using the DIP Switch* on page 5-30 and *5.4.3 Execution Procedure for Self-configuration Using MPE720* on page 5-32.
- For information on which definition data can be refreshed by executing the self-configuration function, refer to *5.4.4 Definition Data Refreshed by Self-configuration* on page 5-36.

2.2.3 CPU I/O (Built-in I/O) Module

The CPU I/O Module is a digital I/O module built in the MP2300 Basic Module, and provides eight external input points and four external output points.

(1) CPU/I/O Module Details

For CPU I/O Module details including specifications, refer to 3.2.4 CPU I/O (Built-in I/O) Connectors on page 3-16.

(2) Settings for CPU I/O Module (Local I/O definition Window)

Select **MP2300** in the Module Type column of the Controller section in the **Module Configuration** Window, and then double-click the Slot Number cell of **IO**.

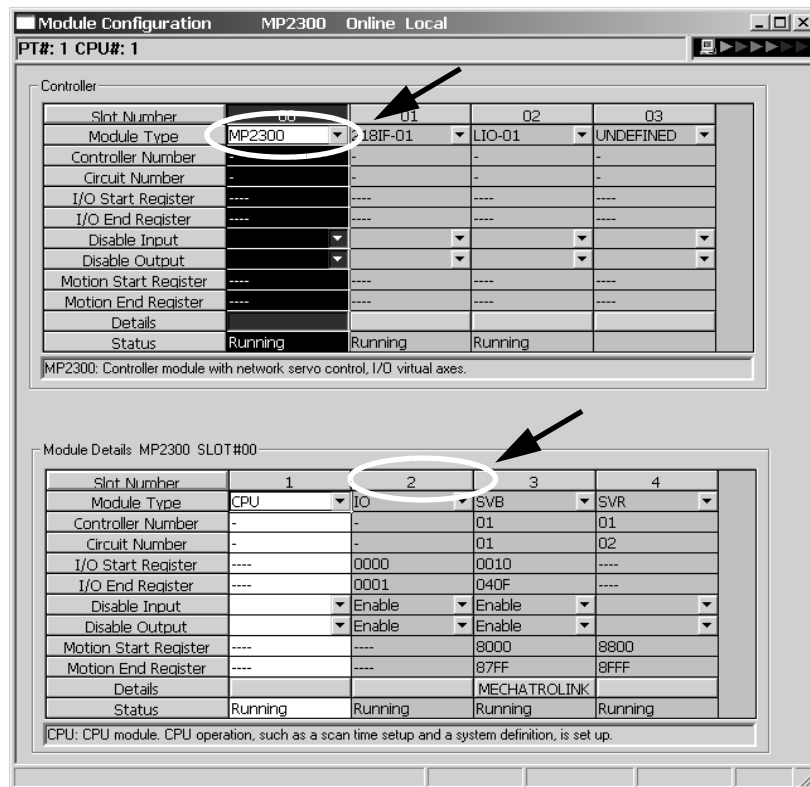

The message box will appear and ask for confirmation to create a new file. Click the **OK** Button to open the Local I/O Window.

The following items are displayed in the **Local I/O** Window. The discrete inputs, discrete outputs, and interrupt inputs can be set.

No.	Item	D	REG	Word	SCAN	Current Value	HEX
1	Local Input	<input type="checkbox"/>	IWD402	1	HIGH		
2	Local Output	<input type="checkbox"/>	OWD403	1	HIGH		
3	IRQ Input	<input checked="" type="checkbox"/>	IBD4020	-----	-		

D : Enable or disable each item by clicking on the cell.

: Enabled, : Disabled

The register length is fixed at one word, i.e., 16 points are set for each input or output register.

REG : Displays the register number allocated to the inputs or outputs. It cannot be changed.

Word : Displays the word size of the register data. It cannot be changed.

SCAN : Select the speed from **HIGH**, **LOW**, or **NA** (none specified), for the scan that processes the inputs or outputs.

Current Value : The current value of the register will be displayed in binary when online. It will not be displayed when offline.

The outputs to external devices can be set by changing the current value of the discrete outputs.

When the set value is confirmed, it is immediately saved in the register.

Other current values cannot be changed.

HEX : The current value of the register will be displayed in hexadecimal when online. It will not be displayed when offline.

After changing the local I/O configuration, save the definition data by selecting **File – Save & Save into flash memory** from the main menu.

2.2.4 Built-in SVB Modules

The SVB Module is a motion module used to control SERVOPACKs, stepping motor drivers, inverters, distributed I/O devices, etc. via MECHATROLINK interface MECHATROLINK-I or -II.

The MECHATROLINK-II enables position, speed, torque, and phase control for highly accurate synchronized control. In addition, sophisticated machine operations can be performed by switching the control mode while the axis is moving.

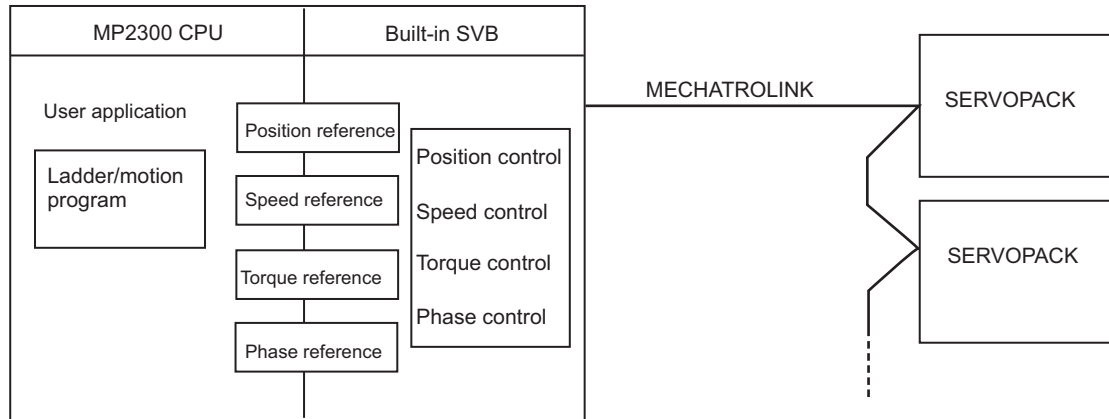

The SVB Modules are of two types: The built-in SVB (hereinafter referred to as Built-in SVB) and the slot-mounting optional SVB (hereinafter referred to as Optional SVB).

A built-in SVB Module is incorporated in MP2300 Basic Module as a standard feature.

- For built-in SVB Module specifications, refer to 2.2.6 *Built-in SVB Specifications* on page 2-25.

The Optional SVB is one of the optional modules for the Machine Controller. The SVB-01 Module is an Optional SVB that can be mounted on MP2300.

(1) Features

- Up to 21 slave stations can be connected to a single SVB Module (the SERVOPACKs can be connected up to 16 axes).
MP2300: Up to 2 SVB-01 Modules can be mounted in optional slots.
Including the built-in SVB, a total of 48 axes can be controlled.
- Synchronization between Modules is also supported, making it suitable for both synchronous control and interpolation across Modules.
- An SVB-01 Module used as a slave can be connected to a host controller equipped with MECHATROLINK communication functions.
- Self-configuration enables automatic allocation of setting data for the slave device that is connected to MECHATROLINK.
- SERVOPACK parameters can be managed over networks.

(2) System Configuration Example

The following diagram shows a system configuration example.

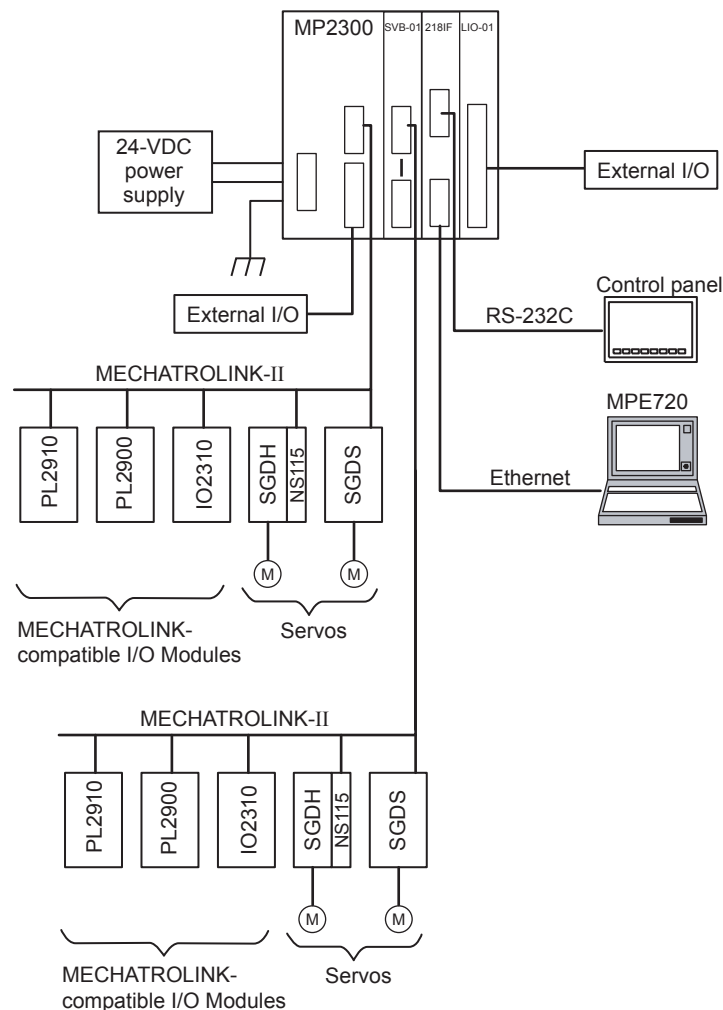

- Use the specified cables and connectors. Refer to 3.2.3 (2) *Cables* on page 3-12 to select appropriate cables and connectors to connect each device.
- The SERVOPACK models that can be connected through MECHATROLINK-I differ from those connected through MECHATROLINK-II. Refer to 1.4.1 *SERVOPACKs* on page 1-7 to select appropriate SERVOPACK models for the MECHATROLINK interface to be used.
- If both MECHATROLINK-I (4 Mbps) compatible devices and MECHATROLINK-II (10 Mbps) compatible devices are connected in a system, make the settings in accordance with MECHATROLINK-I specifications.
- When connecting a servo to an SVB Module via MECHATROLINK, connect signals such as overtravel, homing deceleration switch, and external latch to the servo. Refer to the relevant SERVOPACK manual for details on the connections.
- When connecting Σ -II series SERVOPACKs (SGDH+NS100 or SGDH+NS115), do not connect a hand-held type digital operator and SigmaWin+. If connected, alarms A.95 (command warning) and A.ED (execution not completed) will occur for the commands sent from the SVB Module, and normal operation will be interrupted. If a digital operator or SigmaWin+ must be connected to a Σ -II series SERVOPACK, disconnect the SERVOPACK from the SVB Module.

(3) Synchronization between Modules

[a] Overview

MP2300 Machine Controllers have a function that can synchronize hardware between the CPU and an optional module. This function enables MECHATROLINK communications in synchronization with high-speed scans. As a result, synchronization between a built-in SVB Module and an SVB-01 Module, or among multiple SVB-01 Modules, can be enabled.

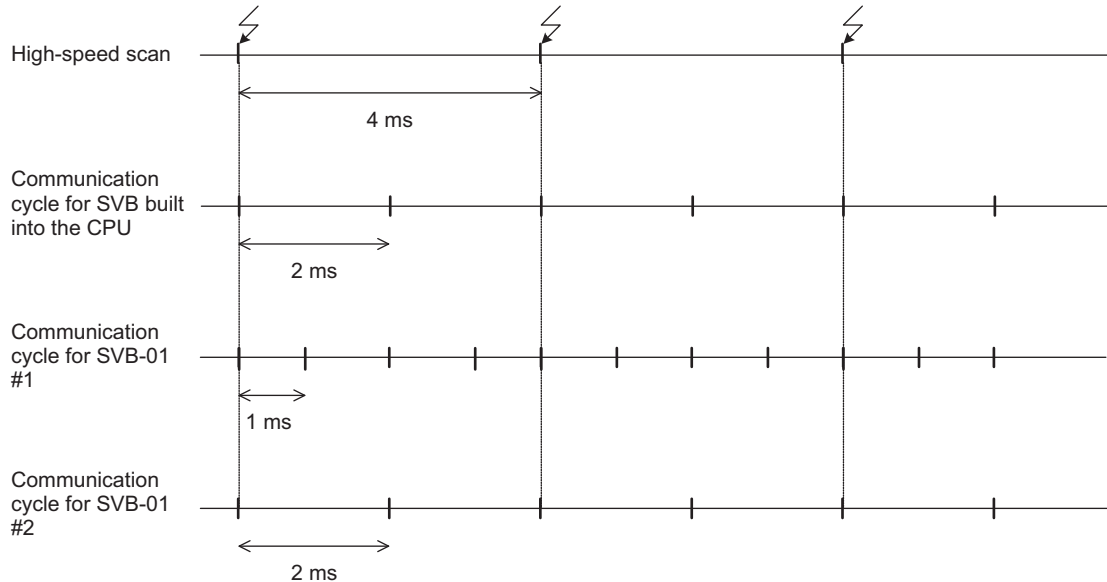

When synchronized mode is used, the start of the high-speed scan and the various communication cycles are synchronized. This means that commands from the high-speed scan will be sent at consistent points in communication cycle processing and simplifies distribution processing for interpolation commands.

[b] Conditions Under Which Synchronization Is Possible

The following table shows the combinations of high-speed scan times and MECHATROLINK communication cycles that allow synchronization between modules in the synchronization mode.

High-speed scan (RTC: 0.5 ms)	MECHATROLINK Communication Cycle			
	0.5 ms	1 ms	1.5 ms	2 ms
1.0 ms	Yes	Yes	–	Yes
1.5 ms	Yes	–	Yes	–
2.0 ms	Yes	Yes	–	Yes
2.5 ms	Yes	–	–	–
3.0 ms	Yes	Yes	Yes	–
3.5 ms	Yes	–	–	–
4.0 ms	Yes	Yes	–	Yes
4.5 ms	Yes	–	Yes	–
5.0 ms	Yes	Yes	–	–
5.5 ms	Yes	–	–	–
6.0 ms	Yes	Yes	Yes	Yes
:				

[c] Timing At Which Modules Are Synchronized

Modules are automatically synchronized when the power supply is turned OFF and ON again.

[d] Operation when High-speed Scan Cycle Is Changed

MECHATROLINK communication with SVB Modules will continue even if the high-speed scan cycle is changed. However, the speed waveform at execution of interpolation command will be disordered. When changing the high-speed scan cycle, do so either with the CPU stopped or when motion command are not being executed. Change the high-speed scan setting and then save the settings to flash memory and turn the power supply OFF and ON when operation changes from synchronized to asynchronous or from asynchronous to synchronized.

[e] Operation When the MECHATROLINK Communication Cycle Is Changed**■ Changing the MECHATROLINK Communication Cycle of the SVB in the CPU**

Synchronization may be lost when a change is made even if synchronization is possible for the high-speed scan and communication cycle combination. When a change is made, save the settings to flash memory and then turn the power supply OFF and ON.

■ Changing the MECHATROLINK Communication Cycle of the SVB-01 Module

Operation will be automatically synchronized when a change is made if synchronization is possible for the high-speed scan and communication cycle combination. It is not necessary to turn the power supply OFF and ON.

[f] Conditions when the Power Supply Must Be Turned OFF and ON

When any of the following operations is performed, save the settings to flash memory and then turn the power supply OFF and ON.

- After executing a self-configuration command from the MPE720 after turning ON the power supply
- After loading a Module definition after turning ON the power supply
- After changing the SVB communication cycle in the CPU after turning ON the power supply
- After operation changes from synchronized to asynchronous or from asynchronous to synchronized when the high-speed scan setting is changed

2.2.5 Setting SVB Module

A SERVOPACK connected to MECHATROLINK can be controlled by executing the MECHATROLINK transmission definition and SVB definition with the MPE720 Engineering Manager.

(1) MECHATROLINK Transmission Definition

[a] How to Open the MECHATROLINK Transmission Definition Window

In the **Module Configuration** Window, select the **SVB** Module in the **Controller** field and double-click the **MECHATROLINK** cell in the **Details** field. The **MECHATROLINK Transmission Definition** Window will open.

- To check or set the built-in SVB Module, select slot number **00** in the **Controller** field.
- If several SVB Modules are mounted, select the SVB Module to be checked or set in the **Controller** field.

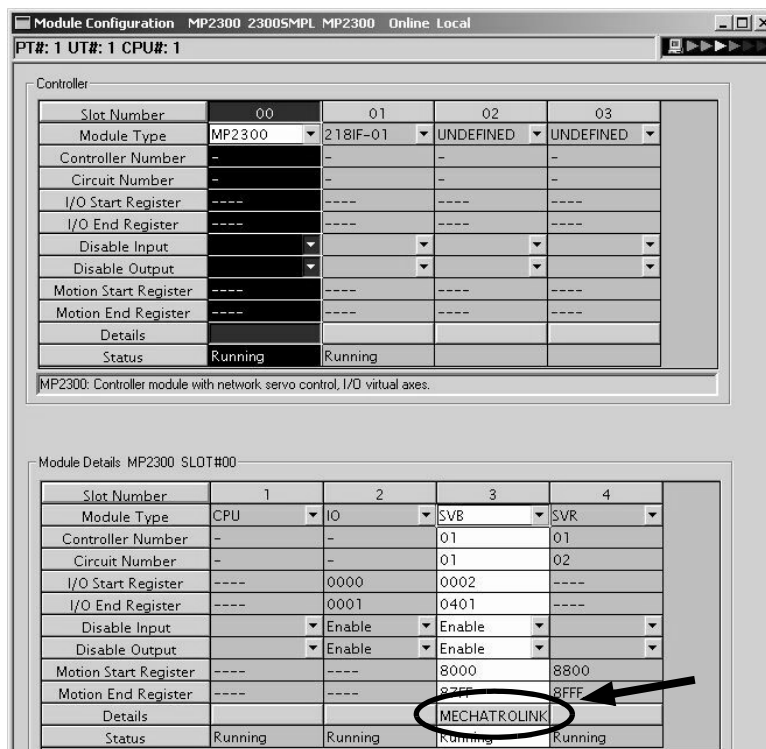

[b] MECHATROLINK Transmission Definition Window Details

The **MECHATROLINK Transmission Definition** Window has four tabs: Transmission Parameters, Link Assignment, I/O Map, and Status. Click the tab to view each.

1. Transmission Parameters Tab

The parameters required to use the MECHATROLINK transmission system are displayed.

<Communication Method in MECHATROLINK-II> <Communication Method in MECHATROLINK-I>

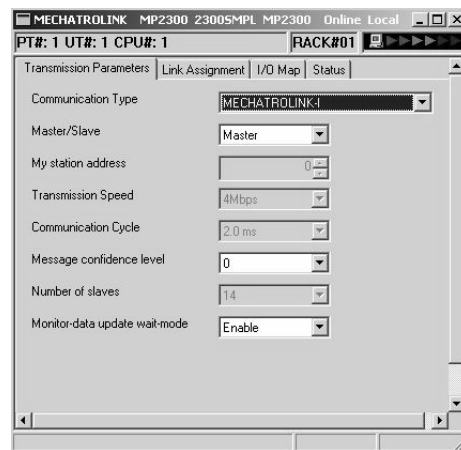
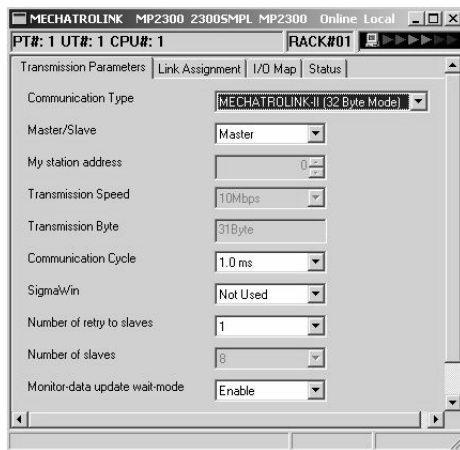

The items shown on the **Transmission Parameters** Tab are described in the following table. For items whose input fields are available, the settings can be changed. Always save the settings to the flash memory after changing them.

Item	Display during Self-configuration	Options and Precautions on Settings
Communication Type	Displays the detected communication method.	Select MECHATROLINK-II (32 Byte Mode) , MECHATROLINK-II (17 Byte Mode) , or MECHATROLINK-I .
Master/Slave	Displays whether the selected SVB Module is used as a Master station or Slave station.	Select either Master or Slave . A built-in SVB (slot number 00) is fixed to Master .
My station address (Local station address)	Displays the local station address set by using the rotary switches.	For Master station, fixed to 0. For slave stations, set a number between 1 and the number of slave stations.
Transmission Speed	Displays the transmission speed: MECHATROLINK-II (32-byte mode): 10 Mbps MECHATROLINK-II (17-byte mode): 10 Mbps MECHATROLINK-I: 4 Mbps	Cannot be set.
Transmission Bytes (Hidden for MECHATROLINK -I)	Displays the number of transmission bytes. The number of transmission bytes depends on the communication type and the station type, Master or Slave. Refer to ■ <i>Transmission Bytes, Communication Cycle, Number of Retries to Slaves, Number of Slaves</i> for details.	Cannot be set.
Communication Cycle	Displays the communication cycle. The number of transmission bytes depends on the communication type and the station type, Master or Slave. Refer to ■ <i>Transmission Bytes, Communication Cycle, Number of Retries to Slaves, Number of Slaves</i> for details.	Can be set only for the Master station and when MECHATROLINK-II is selected as the communication type. The value that can be set differs depending on whether the SVB Module is a built-in SVB Module or optional SVB Module. Refer to ■ <i>Communication Cycle That Can be Set</i> for details.
Message Confidence Level (Hidden for MECHATROLINK -II)	Not used for MECHATROLINK transmission.	Set to 0 (default).

(cont'd)

Item	Display during Self-configuration	Options and Precautions on Settings
SigmaWin+ (Hidden for MECHATROLINK -I)	For MECHATROLINK-II communications, displays whether or not to use SigmaWin+ for communication via MECHATROLINK-II adapter such as JUSP-NP115.	Select either <i>use</i> or <i>not use</i> .
Number of Retries Slaves (Hidden for MECHATROLINK -I)	Displays the maximum number of slave stations to which the Master can retry transmission in one transmission cycle when the Master has not received a normal response from a slave.	Only for Master station. Set a number between 0 and 7. Cannot set for Slaves.
Number of Slaves	Displays the number of slave stations that can be connected. Determined by communication type, communication cycle, use of SigmaWin+, and number of attempts to retry transmission to slaves.	Cannot be set.
Wait for Monitor Data Update (Hidden for built-in SVB Modules)	Displays whether or not to suspend CPU processing for the scan delay time of monitoring parameters of an optional SVB Module. Suspended when enabled, not suspended when disabled.	Select either <i>Enable</i> or <i>Disable</i> . Refer to ■ <i>Wait for Monitor Data Update</i> for details on this function.

■ Transmission Bytes, Communication Cycle, Number of Retries to Slaves, Number of Slaves

Transmission bytes, communication cycle, number of retries to slaves, and number of slaves at execution of self-configuration will be automatically set according to conditions including communication type, station type (Master or Slave), and the largest slave station number (the largest number among the detected slave station numbers).

<For Master Station>

Item	MECHATROLINK-II (32-byte mode)				MECHATROLINK-II (17-byte mode)		MECHATRO- LINK-I
	1 to 8	9	10 to 16	17 to 21	1 to 14	15	
Largest Slave Station Number	1 to 8	9	10 to 16	17 to 21	1 to 14	15	
Transmission Bytes	31 bytes				16 bytes		–
Communication Cycle	1 ms	1 ms	2 ms	2 ms	1 ms	1 ms	2 ms
Number of Retries to Slaves	1	0	5	21–The largest slave station number	1	0	14
Number of Slaves	8	9	16	The largest slave station number	14	15	14

<For Slave Stations>

Item	MECHATROLINK-II (32-byte mode)	MECHATROLINK-II (17-byte mode)	MECHATROLINK-I
Transmission Bytes	–	–	–
Communication Cycle	1 ms	1 ms	2 ms
Number of Retries to Slaves	30	30	15
Number of Slaves	30	30	15

■ Communication Cycle That Can be Set

The communication cycle that can be set will differ depending on the SVB Module type (built-in SVB or optional SVB) and the communication type as follows.

SVB Module Type	Built-in SVB		Optional SVB	
MECHATROLINK-II Communication Mode	32-byte mode	17-byte mode	32-byte mode	17-byte mode
Communication Cycle That Can be Set	1 ms, 1.5 ms, or 2 ms	Fixed to 1 ms	0.5 ms, 1 ms, 1.5 ms, or 2 ms	0.5 ms or 1 ms

- Communication Cycle can only be set for Master.
- The communication cycle for MECHATROLINK-I is fixed to 2 ms.

■ Wait for Monitor Data Update

The SVB-01 Module (optional SVB) exchanges data with the Machine Controller’s CPU using the real shared memory. In this process, the time until the motion parameters created on the SVB-01 Module can be monitored in CPU applications is one scan longer than when using a built-in SVB Module. (See the following diagram.)

<Data Exchange Process with Built-in SVB Module>

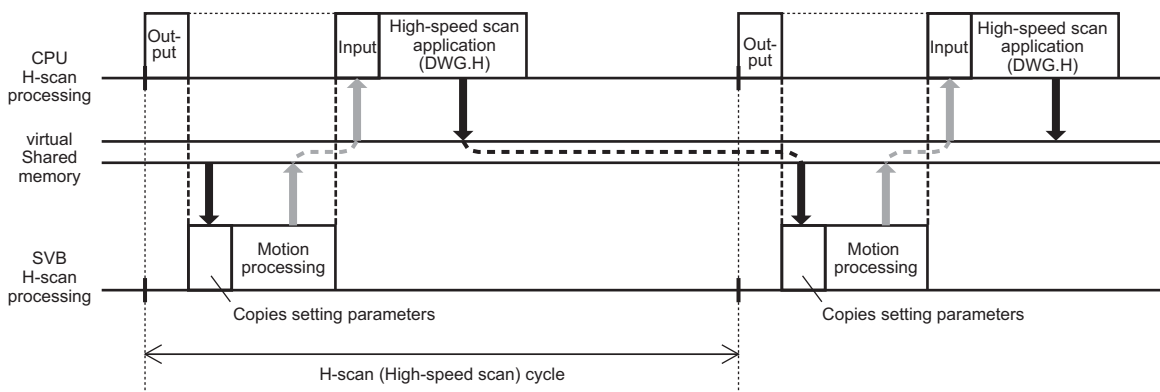

<Data Exchange Process with Optional SVB Module>

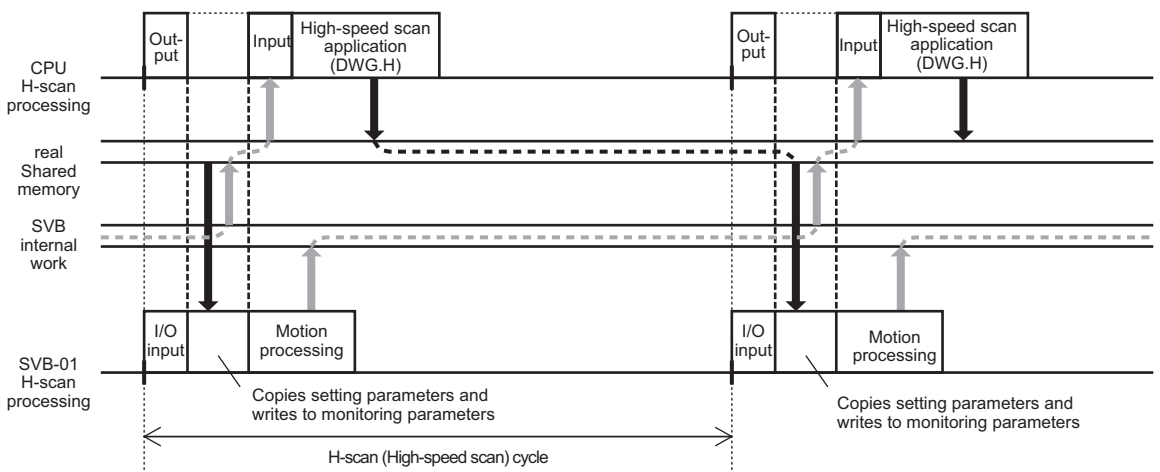

The Wait for Monitor Data Update Mode (when Wait for Monitor Data Update is enabled) solves the problem of this one-scan delay, so the motion monitoring parameters can be monitored with the same timing as a built-in SVB Module. The time required for CPU high-speed scan processing, however, will be longer because the CPU’s application execution start time is suspended until the SVB-01 Module motion processing is completed.

2. Link Assignment Tab Page

The data of the slave devices (MECHATROLINK connected devices such as SERVOPACK, inverter, and distributed I/O) are displayed on the **Link Assignment Tab**.

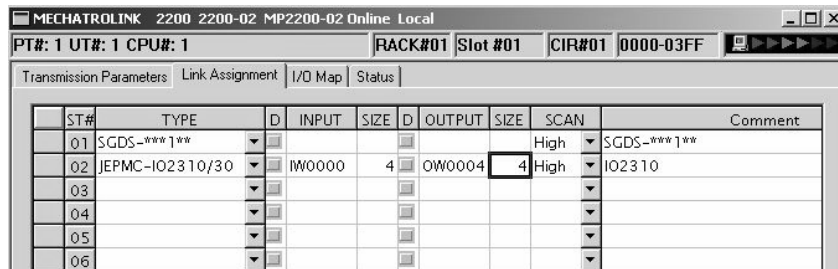

The items shown on the **Link Assignment Tab** are as follows. You can change the settings or delete the data station by station on this tab. Always save the settings to the flash memory after changing them.

Item	Description	Options and Precautions on Settings
ST #	Station number	The station number set here must be the same as the number set using rotary switches.
TYPE	Slave device connected at the station	Select the device type from the pull-down list.
D	I/O register's enable/disable status <input type="checkbox"/> : Enabled <input checked="" type="checkbox"/> : Disabled	Click the button to switch the status.
INPUT, SIZE	The leading input register number (<i>INPUT</i>) and the number of input registers in words (<i>SIZE</i>). The maximum number of input registers will be automatically set in <i>SIZE</i> .	When setting, be careful not to overlap the register range among stations. The register numbers that can be set are in the range between the leading register number and the ending register number in the Module Configuration Definition Window.
OUTPUT, SIZE	The leading output register number (<i>OUTPUT</i>) and the number of output registers in words (<i>SIZE</i>). The maximum number of output registers will be automatically set in <i>SIZE</i> .	When setting, be careful not to overlap the register range among stations. The register numbers that can be set are in the range between the leading register number and the ending register number in the Module Configuration Definition Window.
SCAN	Scan type used for synchronization with CPU. High : High-speed scan Low : Low-speed scan	Select either High or Low . When <i>TYPE</i> is set to a SERVOPACK, fixed to High .
Comment (Station name)	-	Enter a comment of up to 32 characters for each station.

■ Deleting a Station Assignment

Click any cell in the row of the station to be deleted, and select **Edit - Assignment Delete** from the main menu.

- Care must be taken when deleting a station assignment. The deletion is irreversible.

■ *****/I/O and *****/SERVO in Type

The following slave devices (I/O Modules) do not have model codes. Therefore, "*****/I/O" (wild card I/O) will be displayed in **TYPE** for these devices after execution of self-configuration.

- JEPMC-IO350
- JAMSC-120DAI53330
- JAMSC-120DAI73330
- JAMSC-120DAO83330
- JAMSC-120DRA83030

For a servo with customized specifications that could not be recognized by self-configuration, "*****/SERVO" (wild card servo) will be displayed in **TYPE**.

Select a correct device type in the Link Assignment Tab Page for the devices with *****/I/O or *****/SERVO displayed in **TYPE**.

3. I/O Map Tab

The status allocated to I/O registers is displayed.

- The **I/O Map** Tab is used for monitoring (read-only). Do not change the displayed settings.

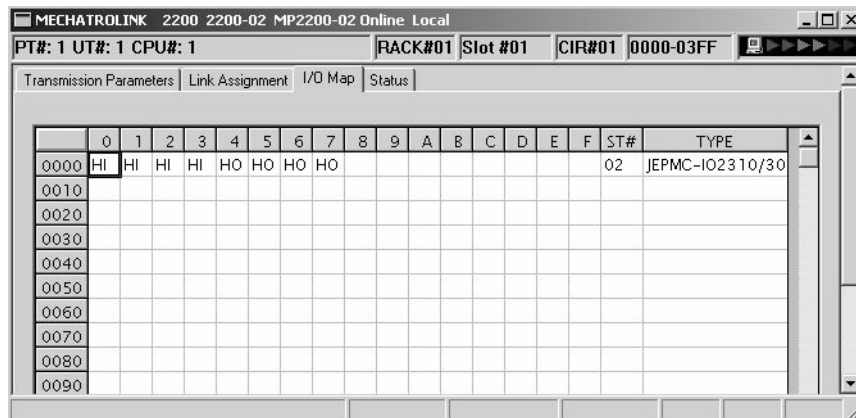

4. Status Tab Page

The MECHATROLINK transmission status is displayed. The displayed settings cannot be changed.

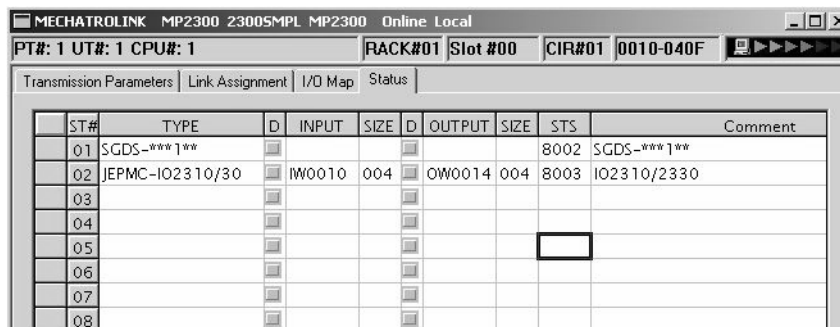

The items shown on the **Status** Tab are the same as those on the **Link Assignment** Tab except for STS.

■ STS

In online mode MECHATROLINK transmission status information is displayed in hexadecimal.

- In offline mode, nothing will be displayed.

The meaning of each bit is shown below.

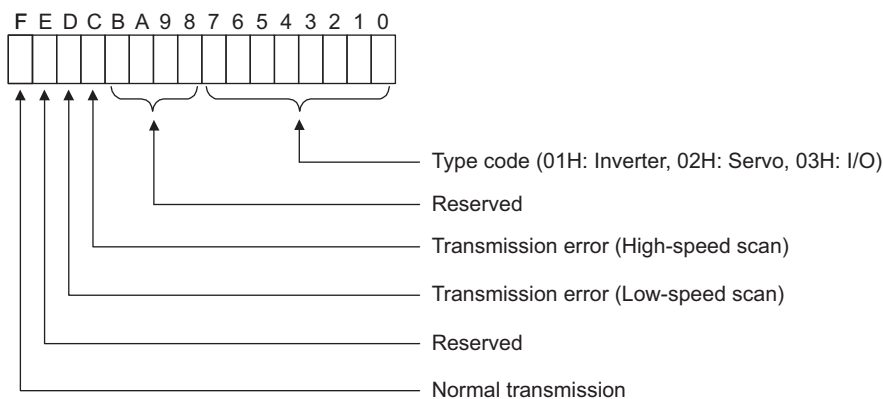

(2) SVB Definition

The SVB Definition file defines the motion parameters (motion fixed parameters, motion setting parameters, and motion monitoring parameters) to control motion axes such as the SERVOPACK, inverter, and stepper.

- Refer to *D Motion Parameter Lists* on page A-19 for details on motion parameters.

[a] Opening the **SVB Definition** Window

Open the **SVB Definition** Window by the following procedure.

1. Double-click the slot number cell of the SVB Module in the **Module Details** field in the **Module Configuration** Window (refer to 2.2.2 (1) *Module Configuration Window Components* on page 2-9).

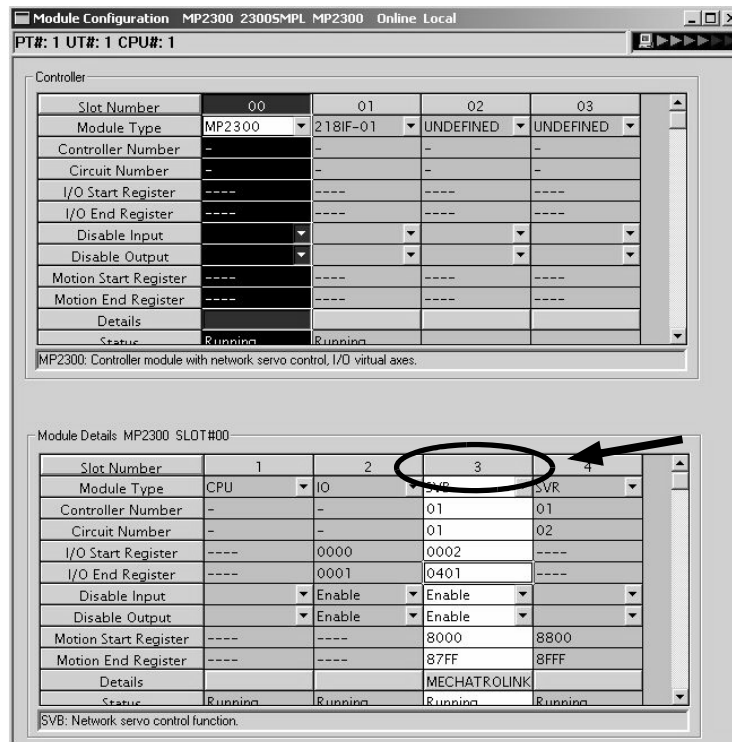

The **Create New Confirmation** Dialog Box will open. Click **OK** to display the **Fixed Parameters** Tab of the **SVB Definition** Window.

2. Select the axis to be set or monitored from the **Axis** pull-down list.

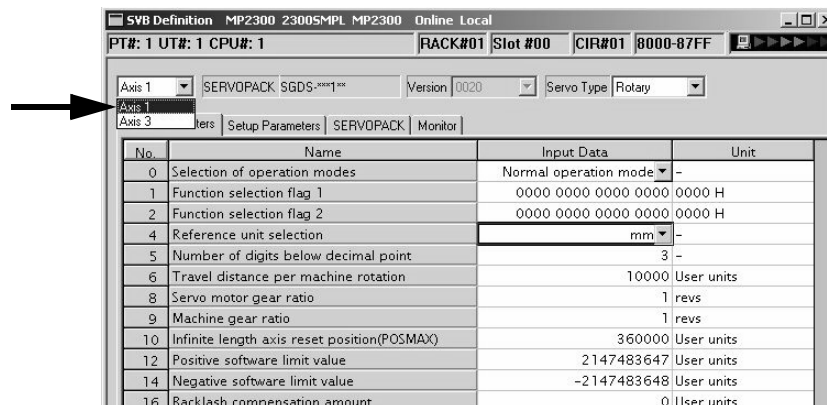

- **Axis** corresponds to **ST#** (station number) in the **Link Assignment** Tab of the **MECHATROLINK Transmission Definition** Window.

3. Click the **Fixed Parameters**, **Set Up Parameters**, or **Monitor** tab to display the desired page.

- If the setting in **Servo Type** is switched from Rotary to Linear, or vice-versa, some of the displayed parameters will change. Refer to 4.2.2 *Motor Type and Related Alarms* in *Machine Controller MP2000 Series Built-in SVB/ SVB-01 Motion Module User's Manual* (Manual No.: SIEPC88070033) for details.

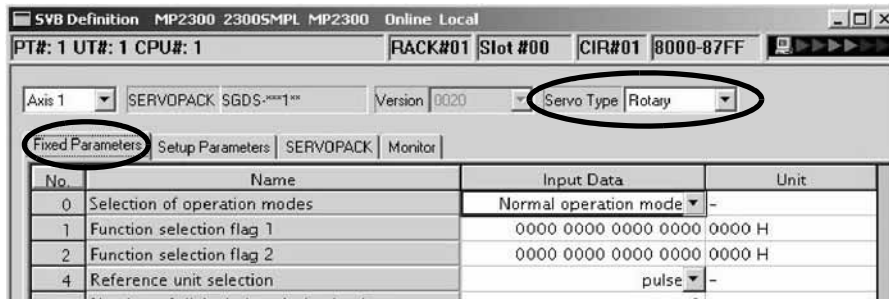

Fig. 2.1 Fixed Parameters Tab

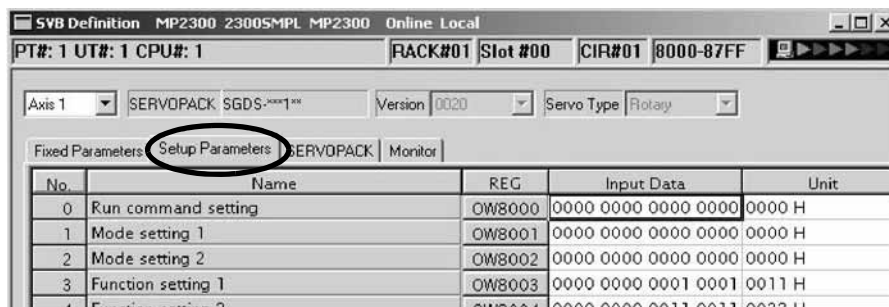

Fig. 2.2 Setup Parameters Tab

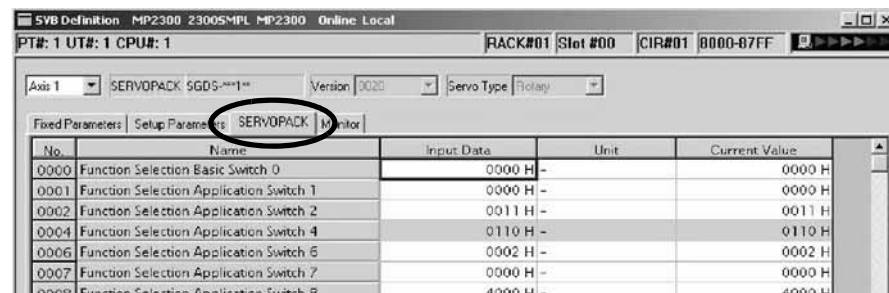

Fig. 2.3 SERVOPACK Parameters Tab

- Refer to the relevant SERVOPACK user's manual for information on SERVOPACK parameters.
- When using a **SERVOPACK** parameter window to save (excluding when the SERVOPACK is replaced), make sure to select **Edit-SERVOPACK Current value-Setting Value**.
- Refer to *B Current Values and Set Values (Input Data) in the SVB Definition Window* on page A-5.

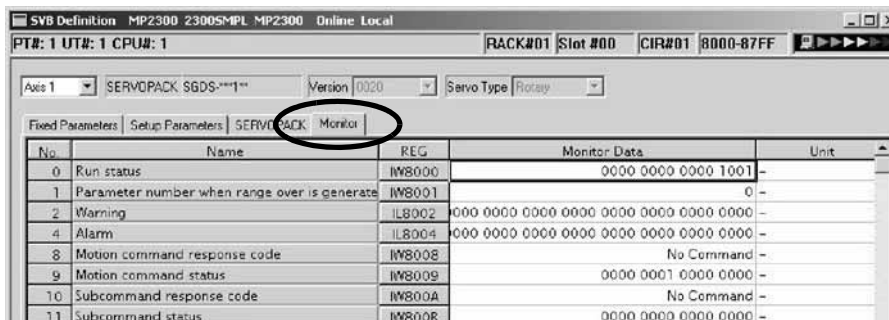

Fig. 2.4 Monitor Parameters Tab (read-only)

2.2.6 Built-in SVB Specifications

[a] MECHATROLINK Communication Specifications

Item	MECHATROLINK-I	MECHATROLINK-II
Topology	Bus	Bus
Transmission Path	Electric bus	Electric bus
Transmission Distance	50 m (Can be extended up to 100m by connecting repeaters*.)	50 m (Can be extended up to 100m by connecting repeaters*)
Baud Rate	4 Mbps	10 Mbps
Communication Cycle	2 ms	1 ms, 2 ms
Maximum Number of Connectable Stations	14	21
Communication Control Method	Cyclic	Cyclic
Media Access Control Method	1:N	1:N (2:N when using SigmaWin+)
Communication Mode	Control communication	Control communication
Error Detection Control	CRC check	CRC check

* Applicable repeater model: JEPMC-REP2000

[b] MECHATROLINK Communication Settings and Max. Number of Slaves

MECHATROLINK Communication Settings			Max. Number of Slaves
Communication Method	Baud Rate	Communication Cycle	
MECHATROLINK-I	4Mbps	2 ms	14
MECHATROLINK-II (17-byte mode)	10Mbps	1 ms	15
MECHATROLINK-II (32-byte mode)	10Mbps	1 ms	9
		1.5 ms	15
		2 ms	21 (16 axes max. for Servos)

• Refer to 8.8.6 MECHATROLINK Definition in Machine Controller MP900/MP2000 Series MPE720 Software for Programming Device User's Manual (Manual No.: SIEP C880700 05) for information on MECHATROLINK communication settings.

[c] Transmission Distance and Max. Number of Slaves

Communication Method	Transmission Distance (Total Network Length)	Max. Number of Slaves
MECHATROLINK-I	50 m	14
MECHATROLINK-II	30 m (Can be extended up to 100m by connecting repeaters)	16 (21)*
	50 m (Can be extended up to 100m by connecting repeaters)	15 (21)*

* The max. number of slaves in parentheses are when repeaters (JEPMC-REP2000) are used. For MECHATROLINK-II communication, repeaters (JEPMC-REP2000) are required to connect more than 17 slave stations.

2.2.7 SVR Virtual Motion Module

(1) Outline

The Virtual Motion Module is a software module provided as a standard feature with the MP2300. It is not connected to a motor, but provides a virtual axis interface.

The SVR is configured in the same way as the MP2300 built-in SVB with fixed parameters, setting parameters, and monitoring parameters, and can be accessed from application programs using I/O registers.

- Refer to *Machine Controller MP2000 Series Built-in SVB/SVB-01 Motion Module User's Manual* (Manual No.: SIEPC88070033) for detailed information on SVR motion parameters and motion commands.

The SVR can be used to control up to 16 virtual axes in the high-speed scan control cycle.

In the MP2300 Basic Module, slot 4 in the default Module Configuration Window is for SVR.

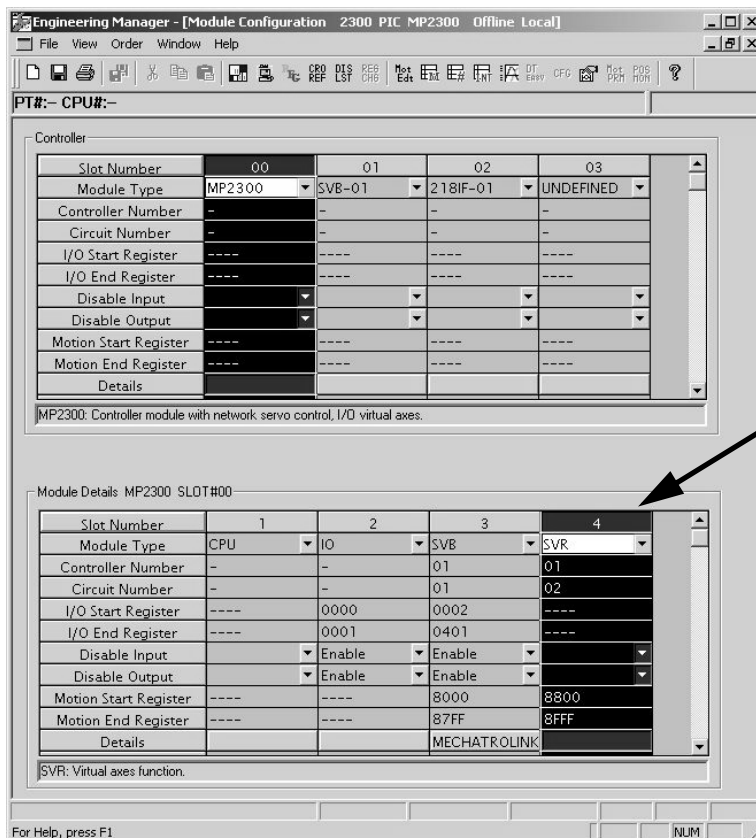

- If the SVR is not used, MP2300 processing time can be reduced by setting the *Module Type* for SVR to **UNDEFINED** in the Module Configuration Window.

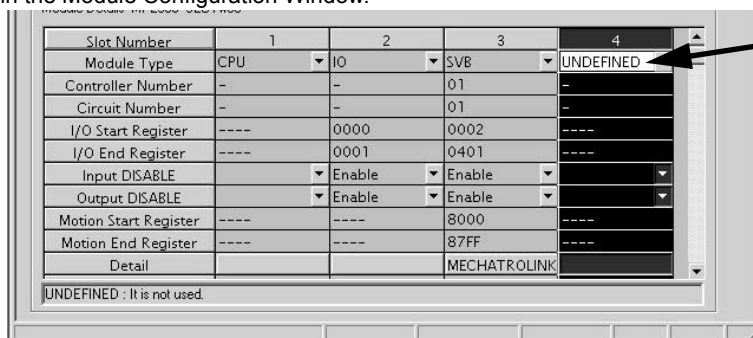

(2) Example SVR Usage

The SVR is used in the following two applications.

- **Program testing:** Results are easily obtained without mounting a motor.
- **Generating commands:** If the SVR is used in applications where motion modules are required only for generating commands, such as master axis for phase control or multi-axis synchronous control, then Motion Modules on real axes are no longer required.

The following table lists application examples of the SVR.

Slot Number	Application Example	Application Method
1	Master axis for phase control	Electronic cam or shaft operation can be achieved by using the SVR for the virtual master axis.
2	Multi-axis synchronous control	Multi-axis synchronous control can be achieved by controlling the SVR from a motion program and then using the ladder program to copy position commands of the SVR to other axes.
3	Sine curve commands	If the motion program is used to perform circular interpolation with the SVR, the axis will operate with a sine curve command.

- The software limit function and machine lock function cannot be used with the SVR. The position error will always be 0.

(3) System Configuration Example

The following figure shows an example system configuration using SVR.

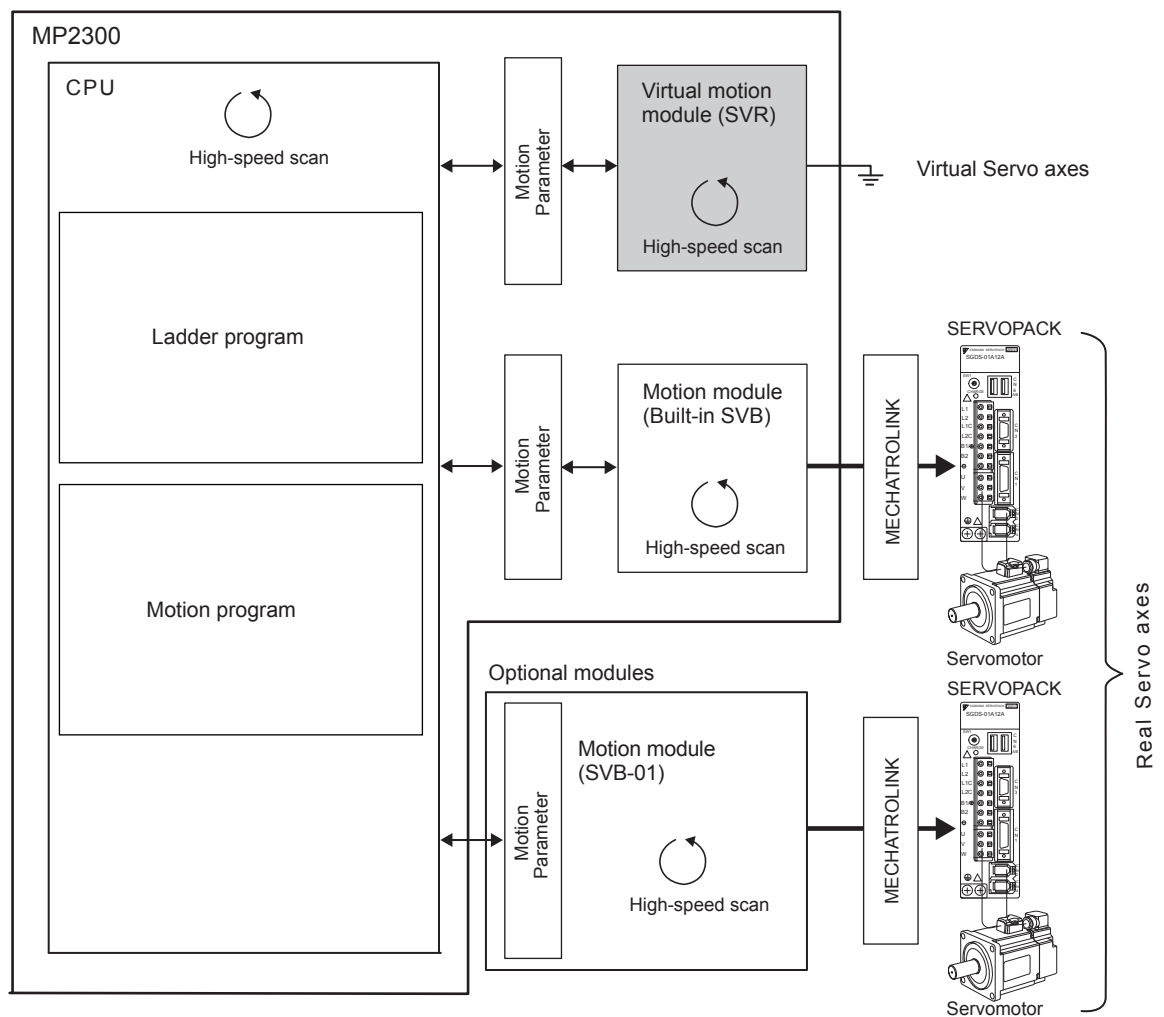

(4) SVR Operation

[a] SVR Execution Timing

The SVR is processed at the beginning of the high-speed scan. SVR processing is performed in the next scan after specifying and the processing results are reflected in the monitoring parameters.

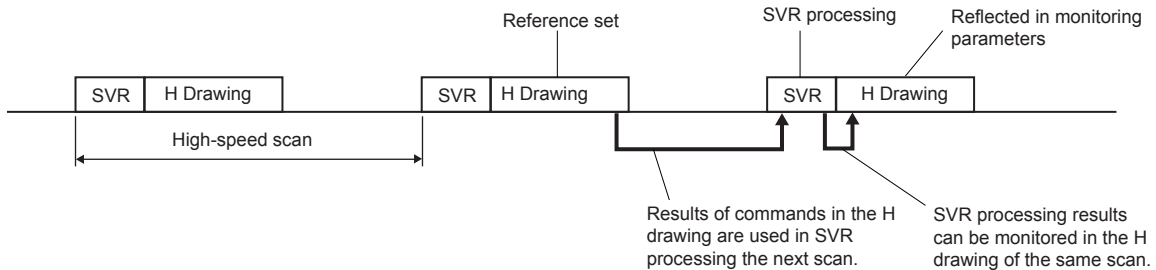

[b] Processing Time

When fixed parameter 0 (Run Mode) is set to 0 (Normal Running), services are started for each of the 16 SVR module virtual axes.

- The default for the Run Mode parameter is 1 (Axis Unused).

The following table gives guidelines for the processing time required for each SVR axis.

Command	MP2300
NOP	$35 + 14 \times \text{Number of axes} (\mu\text{s})$
POSING	$35 + 36 \times \text{Number of axes} (\mu\text{s})$

- Number of axes: The number of axes (1 to 16) when Run Mode (fixed parameter 0) is set to Normal Running (0). The formula listed above do not apply when the number of axes is 0.

■ Differences from SVB Simulation Mode

Simulation mode does not have a positioning function, so the position data is refreshed in one scan to the final target position. The SVR has its own positioning function that performs distribution, so like a real module, position data is refreshed each scan for the final target position.

Mounting and Connections

This chapter explains how to mount the Basic Module and Optional Modules. Also refer to the connection specifications for the Basic Module.

3.1 Mounting the MP2300	3-2
3.1.1 Basic Module Dimensional Drawings	3-2
3.1.2 Mounting the MP2300	3-3
3.1.3 Replacing and Adding Optional Modules	3-6
3.2 Basic Module Connections Specifications	3-9
3.2.1 Connectors	3-9
3.2.2 Power Supply Connector	3-10
3.2.3 MECHATROLINK Connectors	3-12
3.2.4 CPU I/O (Built-in I/O) Connectors	3-16

3.1 Mounting the MP2300

3.1.1 Basic Module Dimensional Drawings

Refer to the following dimensions for installation.

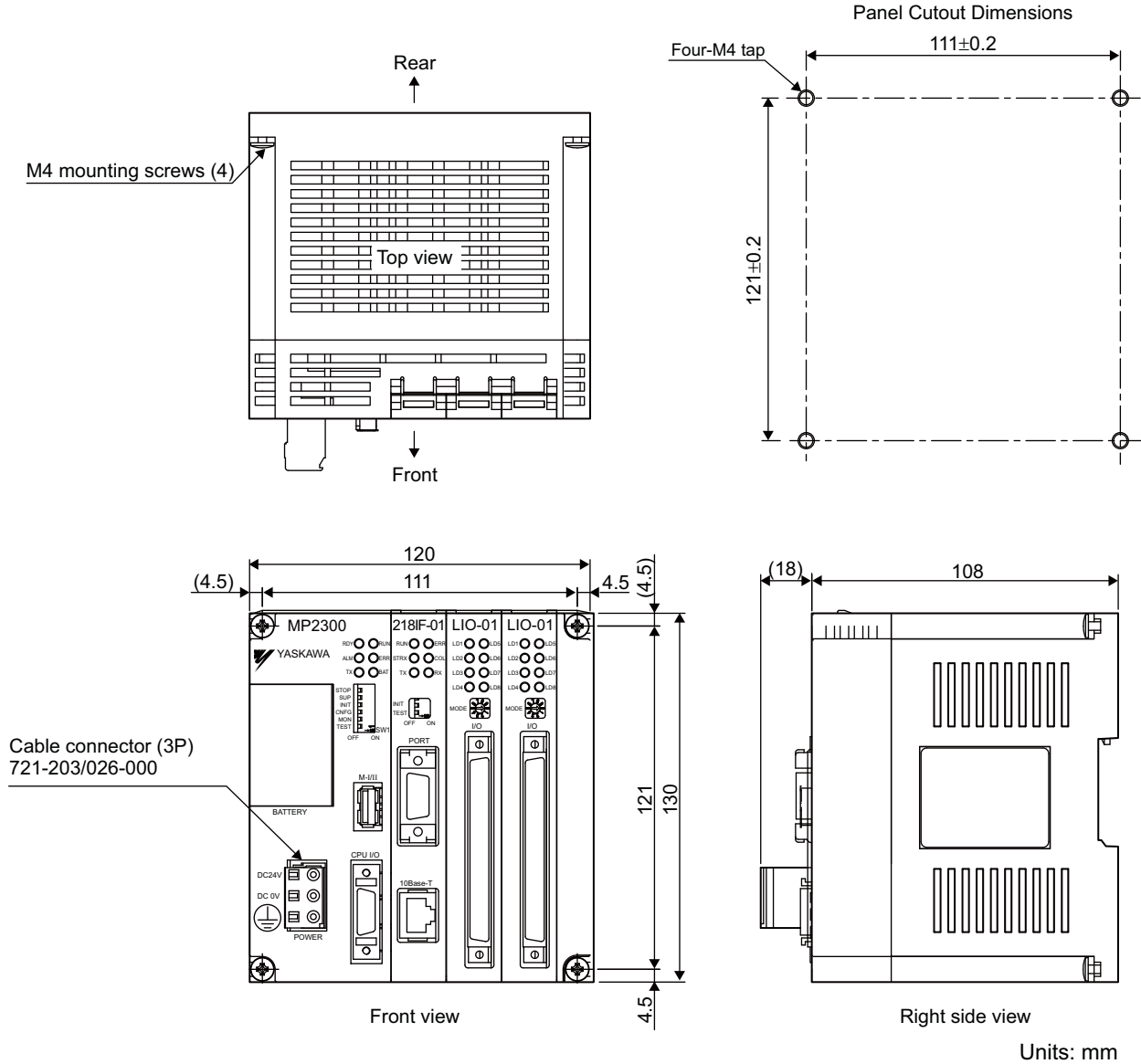

- ♦ A 721-203/026-000 Cable Connector is mounted to the POWER connector. Use this connector and twisted-pair cable and prepare the power cable. Refer to 3.2.2 (2) *Assembling the 24-VDC Power Supply Cable* on page 3-11 for details.
- ♦ Accessory: Operation lever type 231-131



The operation lever is used when connecting wires to the cable connector.

3.1.2 Mounting the MP2300

There are two methods for mounting MP2300.

- Using screws
- Using DIN rail

(1) Screw Mounting

Place the MP2300 against the mounting base and tighten the four mounting screws.

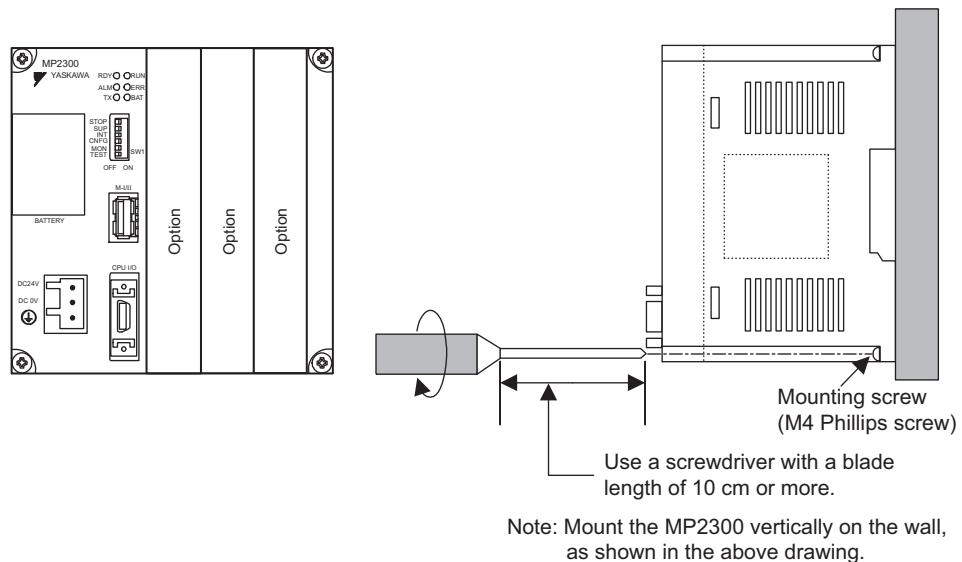

(2) DIN Rail Mounting

[a] DIN Rails and Spacer

Two types of DIN rails are available: with 7-mm or 10-mm gap from the mounting base as shown in the following diagram. If mounting a MP2300 using DIN rail with 10 mm gap, install a spacer on the rear of the MP2300 near the bottom to protect the MP2300 from vibration and shock.

Gap from mounting base: 7.0 mm or 10.0 mm

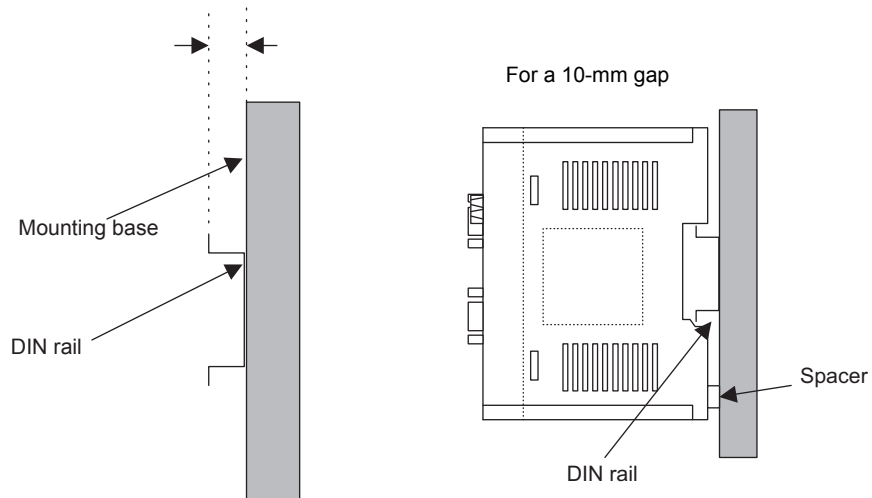

- The parts for mounting the MP2300 to the DIN rail are sold separately. Purchase the following product when using DIN rail.
Product name: DIN Rail Mounting Parts
Model No.: JEPMC-OP300

[b] Procedure for Mounting to DIN Rail

Use the following procedure to attach the DIN rail mounting parts to the MP2300 and then mount the MP2300 to the DIN rail.

1. Insert the DIN rails in the two slots on the rear of the MP2300 as shown in the following figure.

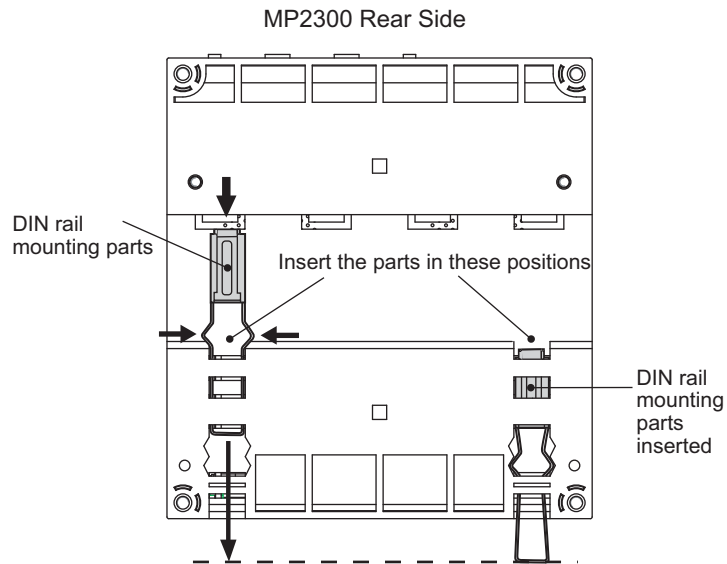

Insert the mounting clips so that they are in the positions shown with a dotted line in the previous figure.

- The figure below shows the front and back of a mounting clip. Insert each clip so that its front faces outward.

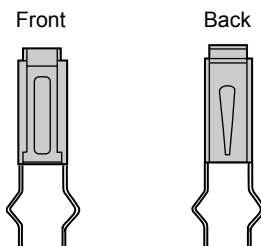

2. Pull the DIN rail mounting clips down to release them.

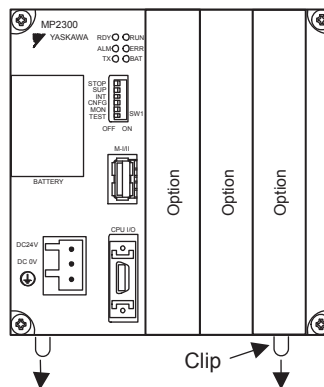

- Hook the MP2300 to the top of the DIN rail (a), and then push the MP2300 towards the mounting base to secure it in place (b).

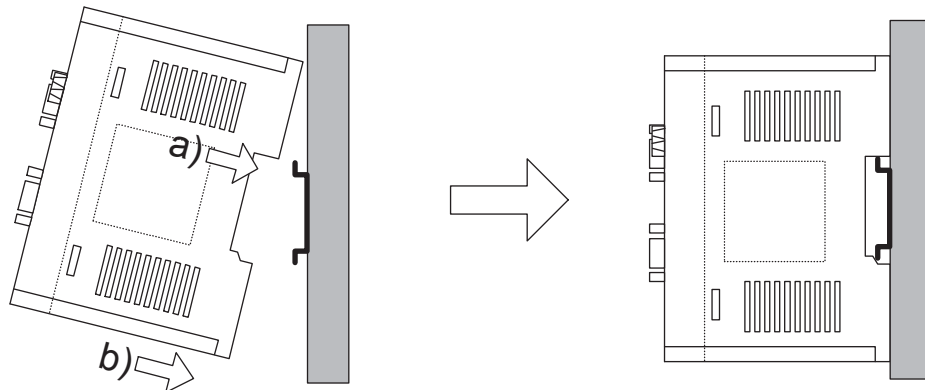

- Push the DIN rail mounting clips to lock them in place.

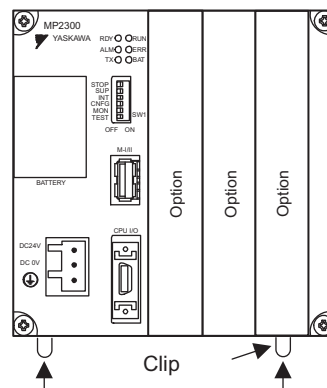

- Place end plates on either side of the MP2300 to secure it to the DIN rail.

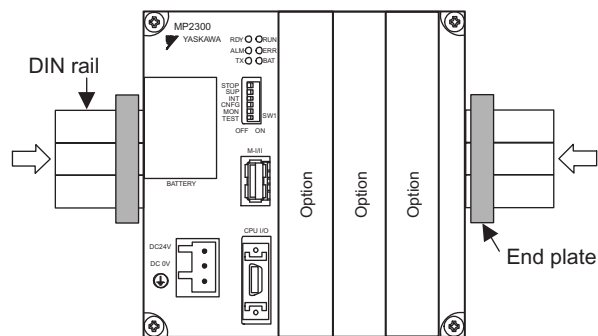

This completes the installation procedure.

3.1.3 Replacing and Adding Optional Modules

Use the following procedures to replace and add Optional Modules.

(1) Preparation

1. Backup the programs.

Save the programs written to the Machine Controller in the personal computer using MPE720.

- MPE720 Ver 5.□□: Right-click the PLC folder and then select **Transfer-All Files-From Controller to MPE720**.
- MPE720 Ver 6.□□: Open the project file and then select **Online-Transfer-Read from Controller**.

2. Remove the MP2300.

Turn OFF the power supply and remove all the cables connected to the MP2300. Next, remove the MP2300 from the panel or rack, and place them where there is sufficient space, such as on a work table.

(2) Removing Optional Modules

1. Remove the Battery Cover.

Insert a hard thin metal object, such as a coin, into the notch on the side of the battery cover and open the cover forward to remove the battery cover.



2. Remove the Option Panel.

Hold the battery cover with the front facing forward, insert the protrusion on the battery cover into the notch at the top of the Module's option panel, and release the hook on the option panel.

- Remove the Option Cover from the empty slot before mounting an Optional Module in an empty slot.

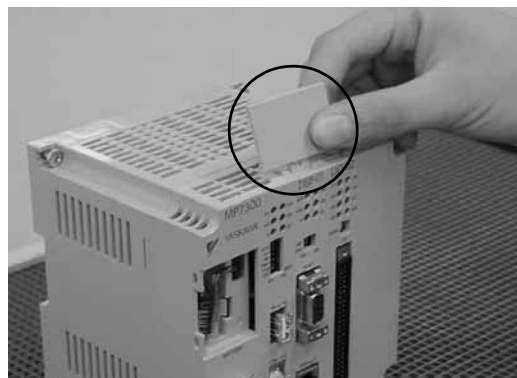

Release the hook on the bottom in the same way and remove the option panel.

3. Remove the Optional Module from the Mounting Base.

Pull out on the top of the option panel and remove it. A notch can be seen in the Communication Module from the gap in the panel. Insert the round projection on the battery cover (see the following figure) into the gap in the panel so that it is inserted in the notch in the Module.

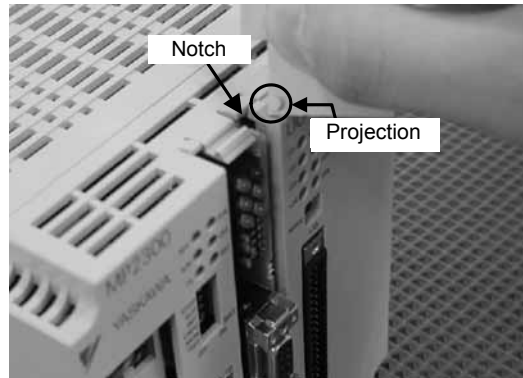

Hold the battery cover as shown in the following figure and use it to gently pull back on the Module, rotating it indicated by the arrows, to disconnect the Module from the Mounting Base. The Module will move towards you.

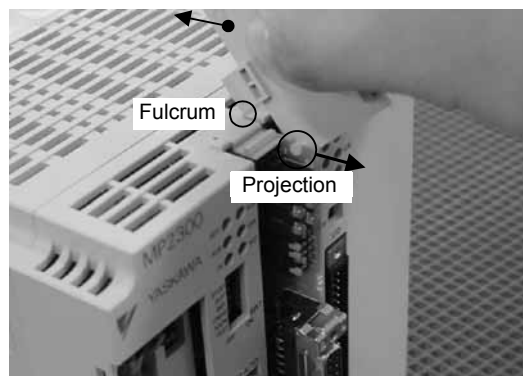

4. Pull out the Optional Module.

Hold onto the top and bottom of the Module with your fingers and pull the Module straight out. Be sure to hold onto the edges of the Module. Do not touch the components mounted to the Module.

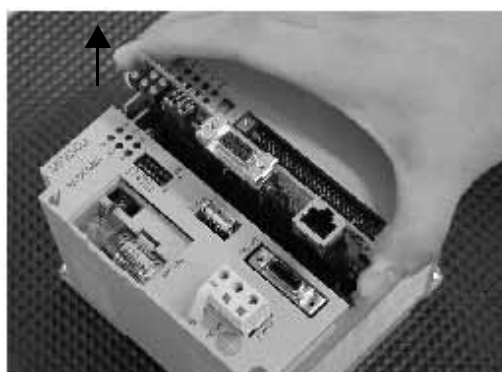

Place the Module that you removed into the bag that it was delivered in and store it.

(3) Mounting Optional Modules

1. Insert Optional Modules.

Hold onto the top and bottom of the Module, align the Module with the left side of the guide rail inside the option slot, and insert the Module straight in.

- If the Module is not inserted on the guide rail, the FG bar on the bottom of the slot may be damaged.

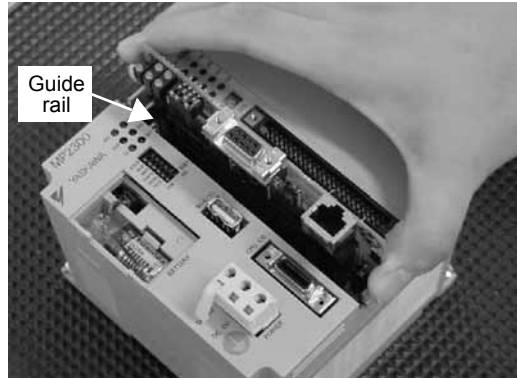

2. Connect to the Mounting Base Connector.

After inserting the Module all the way to the back, press the Module firmly until it connects securely to the Mounting Base connected. If the Module is connected securely, the front of the Module should approximately align with the hooks.

3. Mount the Option Panel.

Insert the hole on the bottom of the option panel into the bottom hook and then securely attach the hole to the top hook.

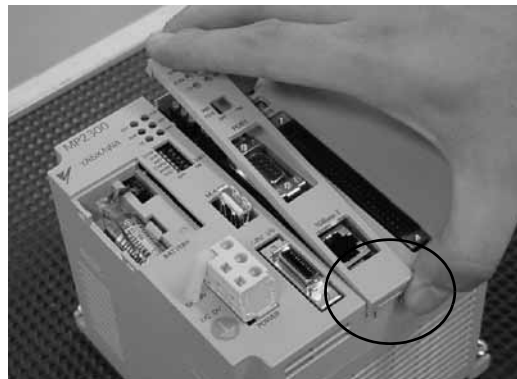

This completes the Optional Module mounting procedure.



- Always attach an Option Cover (JEPMC-OP2300) to any unused slot.

3.2 Basic Module Connections Specifications

3.2.1 Connectors

The following illustration shows the connectors for the Basic Module.

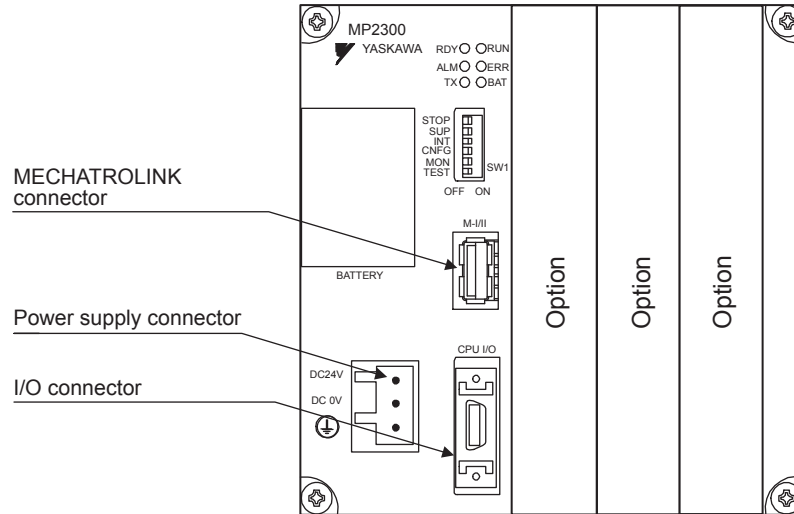

3.2.2 Power Supply Connector

(1) Specifications, Pin Arrangement, and Connection Procedure

Supply a 24-VDC to the MP2300. Connect the power supply connector as shown in the diagram below.

Name	Connector Name	No. of Pins	Connector Model			Cable Model
			Module	Cable	Manufacturer	
Power Supply Connector	POWER	3	721-863	721-203/026	WAGO	-

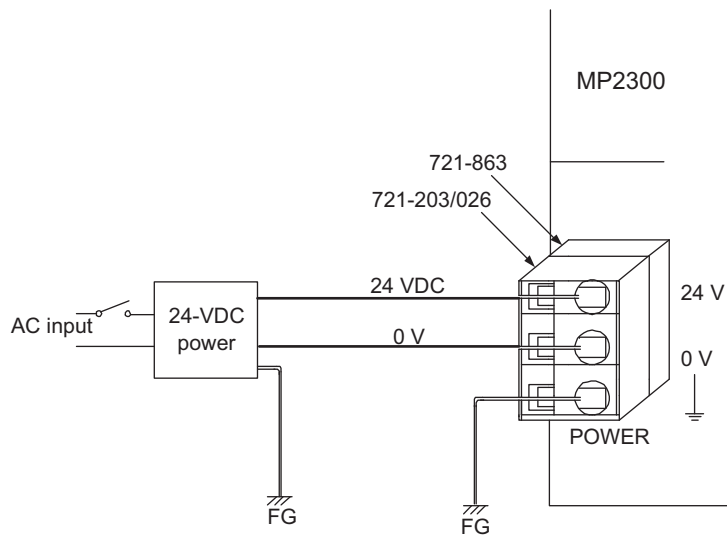
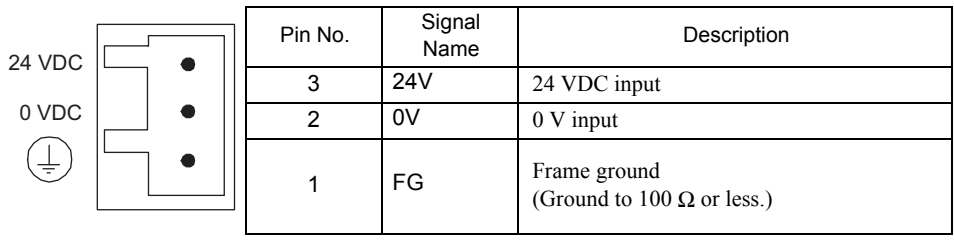

- Use an insulated 24-VDC power supply. Attach the power supply switch on the AC side. If the switch is attached on the 24-VDC side, there will be an inrush current of approximately 40 A when the power is turned ON.

(2) Assembling the 24-VDC Power Supply Cable

A detachable connector is provided for the power supply terminals. Use AWG24 to AWG20 (0.2 mm^2 to 0.51 mm^2) twisted-pair cable to assemble the 24-VDC power supply cable with the following procedure.

1. Strip approx. 6.5 mm from the end of the cable to expose the core wire.

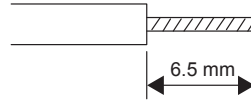

2. Insert the core wire.

Use the lever (provided) or a screwdriver to open the clamp as shown below, and fully insert the core wire into the wire inlet.

Install the lever

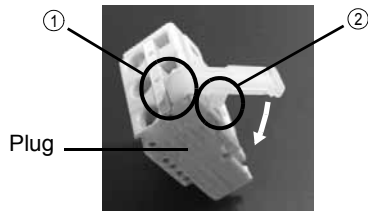

① Insert the hooked end of the lever into the square hole on the plug.

② Press down on the lever until the protrusion enters the hole on top of the plug housing.

Open the clamp by using the lever

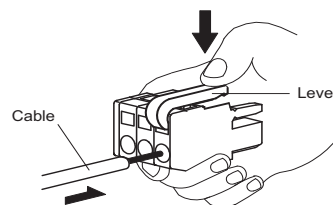

With the lever pressed down, fully insert the core wire into the wire inlet.

Open the clamp by using a screwdriver

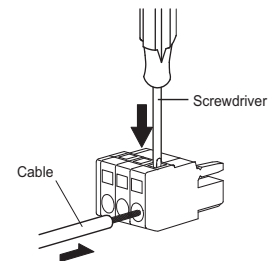

With the tip of screwdriver inserted into the hole on top of the plug housing, fully insert the core wire into the wire inlet.

3. Fasten the clamp.

Release the lever or remove the screwdriver to fasten the clamp so that the core wire will remain securely in the plug.

3.2.3 MECHATROLINK Connectors

MECHATROLINK connector is used to connect the MP2300 and the SERVOPACKs and distributed I/O via MECHATROLINK cables.

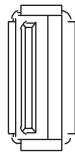

(1) Specifications and Pin Arrangement

Name	Connector Name	No. of Pins	Connector Model		
			Module	Cable	Manufacturer
MECHATROLINK Connector	M-I/II	4	USB-AR41-T11	DUSB-APA41B1-C50	DDK Ltd.

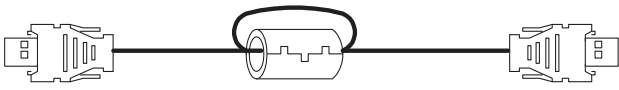

Pin Number	Signal Name	Description
1	(NC)	Not used.
2	/DATA	Signal -
3	DATA	Signal +
4	SH	Not used.
Shell	Shield	Connects the shield wire.

(2) Cables

Name and Specification	Model Number	Length
MECHATROLINK Cable MECHATROLINK Connector – MECHATROLINK Connector 	JEPMC-W6002-A5	0.5 m
	JEPMC-W6002-01	1 m
	JEPMC-W6002-03	3 m
	JEPMC-W6002-05	5 m
	JEPMC-W6002-10	10 m
	JEPMC-W6002-20	20 m
	JEPMC-W6002-30	30 m
	JEPMC-W6002-40	40 m
	JEPMC-W6002-50	50 m
MECHATROLINK Cable MECHATROLINK Connector – MECHATROLINK Connector (with Ferrite Core) 	JEPMC-W6003-A5	0.5 m
	JEPMC-W6003-01	1 m
	JEPMC-W6003-03	3 m
	JEPMC-W6003-05	5 m
	JEPMC-W6003-10	10 m
	JEPMC-W6003-20	20 m
	JEPMC-W6003-30	30 m
	JEPMC-W6003-40	40 m
	JEPMC-W6003-50	50 m
MECHATROLINK Cable MECHATROLINK Connector – Loose Wire (For Σ-I SERVOPACK) 	JEPMC-W6011-A5	0.5m
	JEPMC-W6011-01	1 m
	JEPMC-W6011-03	3 m
	JEPMC-W6011-05	5 m
	JEPMC-W6011-10	10 m
	JEPMC-W6011-20	20 m
	JEPMC-W6011-30	30 m
	JEPMC-W6011-40	40 m
	JEPMC-W6011-50	50 m
Terminator	JEPMC-W6022	-

(3) Cable Connections between the MP2300 or I/O Units or the MP2300 and SERVOPACKs (Except for SGD-□□□N and SGDB-□□AN SERVOPACKs)

Use the MECHATROLINK cable JEPMC-W6002-□□ or JEPMC-W6003-□□ for connection between the MP2300 and I/O units or SERVOPACKs (Except for SGD-□□□N and SGDB-□□AN SERVOPACKs)*1.

The connection diagram using MECHATROLINK cable JEPMC-W6002-□□ or JEPMC-W6003-□□*2 is shown below.

- * 1. Use MECHATROLINK cable JEPMC-W6011-□□ when connecting SERVOPACK SGD-□□□N or SGDB-□□AN.
- * 2. The JEPMC-W6003-□□ cable has a ferrite core.

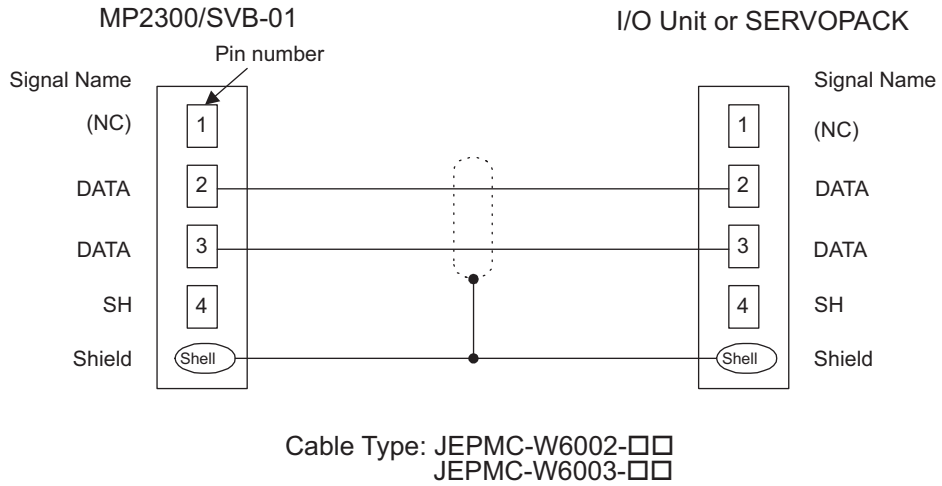

(4) Cable Connections between the MP2300 and SGD-□□□N and SGDB-□□AN SERVOPACKS

Use the MECHATROLINK cable JEPMC-W611-□□ for the connections between the MP2300 and SGD-□□□N or SGDB-□□AN SERVOPACK and between these SERVOPACKs.

The following diagram shows the connections between the MP2300 (or SVB-01) ↔ SERVOPACK ↔ SERVOPACK ↔ SERVOPACK using the MECHATROLINK cables JEPMC-W611-□□.

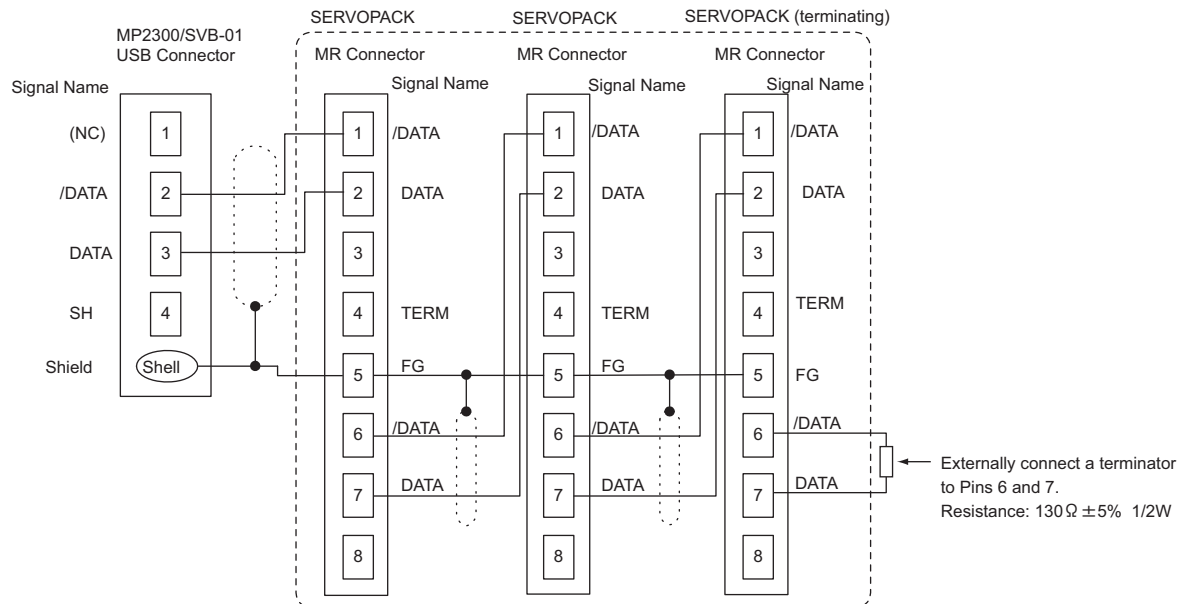

- The JEPMC-6011-□□ has a USB connector on one end and loose wires on the other end. Use an MR connector and wiring material to create a 1:N cable.
- The terminator must be provided by the user.
- The shield wire can be connected as instructed in the SERVOPACK’s manual. However, the connections shown in the above diagram is recommended when using the MP2300 in combination with a SVB-01 Module.
- Prepare the cables according to MECHATROLINK-I specifications. Connections that do not meet the specifications will prevent normal communication due to the influence of reflected waves or other factors.

MECHATROLINK-I Specifications

- Total network length: 50 m max.
- Maximum number of slave stations: 14 stations max.
- Minimum distance between stations: 0.3 m min.

(5) Terminator Connections

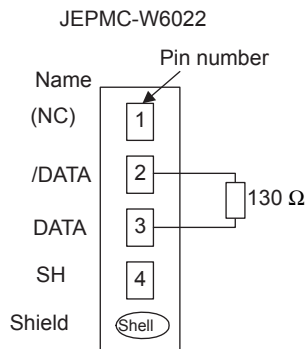

(6) Connection Example between MP2300, SERVOPACK, and IO2310

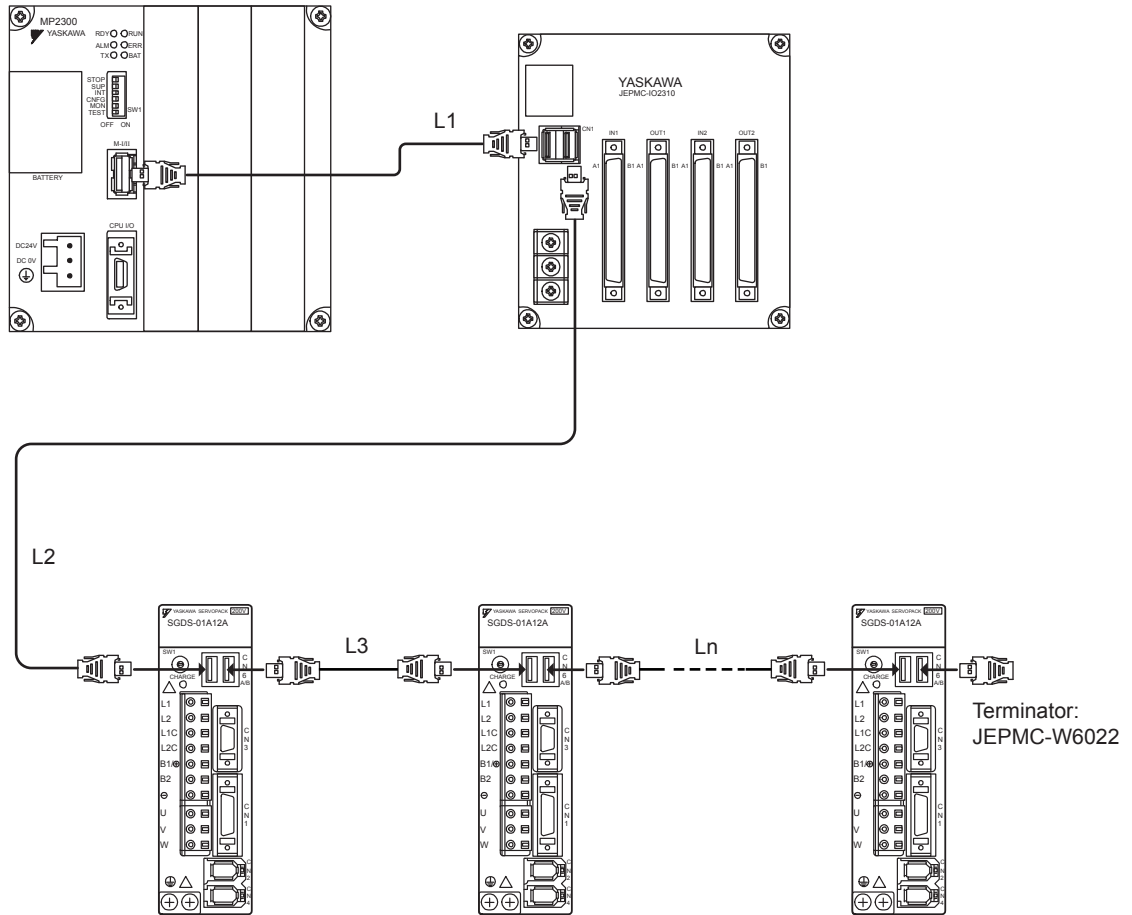

- ◆ Use MECHATROLINK cables between modules.
- ◆ Use under the conditions that $L1 + L2 + L3 + \dots + Ln \leq 50$ m
- ◆ The MP2300 has a built-in terminator.

3.2.4 CPU I/O (Built-in I/O) Connectors

CPU I/O connector is used to connect the MP2300 and external I/O signals.

(1) Specifications

External input: 8 points, External output: 4 points

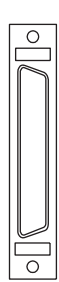

Name	Connector Name	No. of Pins	Connector Model		
			Module	Cable	Manufacturer
I/O Connector	CPU I/O	20	10220-52A2JL	<ul style="list-style-type: none"> 1020-3000VE Connector 10320-52F0-008 Shell 	Sumitomo 3M

(2) Cables

Name	Model Number	Length
I/O Cable (loose wires)	JEPMC-W2060-A5	0.5 m
	JEPMC-W2060-01	1 m
	JEPMC-W2060-03	3 m

(3) External Appearance of I/O Cable

JEPMC-W2060-□□

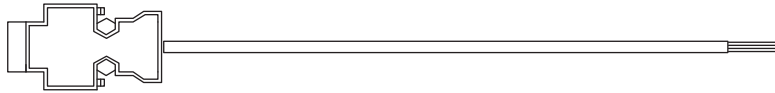

(4) Connector Pin Arrangement

The following table shows the connector pin arrangement.

Pin Number	Signal Name	I/O	Remarks	Pin Number	Signal Name	I/O	Remarks
1	DI_COM	P	Input common	11	DI_COM	P	Input common
2	DI_00	I	Input 00	12	DI_04	I	Input 04
3	DI_01	I	Input 01	13	DI_05	I	Input 05
4	DI_02	I	Input 02	14	DI_05	I	Input 06
5	DI_03	I	Input 03	15	DI_07	I	Input 07
6		–		16		–	
7		–		17	DO_24V	P	+24 V input
8	DO_COM	P	Output common	18	DO_COM	P	Output common
9	DO_00	O	Output 00	19	DO_02	O	Output 02
10	DO_01	O	Output 01	20	DO_03	O	Output 03

♦ P: Power input, I: Input signal, O: Output signal

(5) Input Circuits

The following table shows the CPU I/O Connector input circuit specifications.

Item	Specifications		
Inputs	8 points	DI-00	General-purpose input (shared with interrupts)
		DI-01 to DI-07	General-purpose input
Input Format	Sink mode/source mode input		
Isolation Method	Photocoupler		
Input Voltage	$\pm 24 \text{ VDC} \pm 20\%$		
Input Current	4.1 mA (TYP.)		
ON Voltage/Current	15 VDC min./2.0 mA min.		
OFF Voltage/Current	5 VDC max./1.0 mA max.		
ON Time/OFF Time	ON: 1 ms max. OFF: 1 ms max.		
Number of Commons	1 (8 points/common)		

- DI_00 is shared with an interrupt input. If DI_00 is turned ON while interrupts are enabled, the interrupt processing drawing is executed.

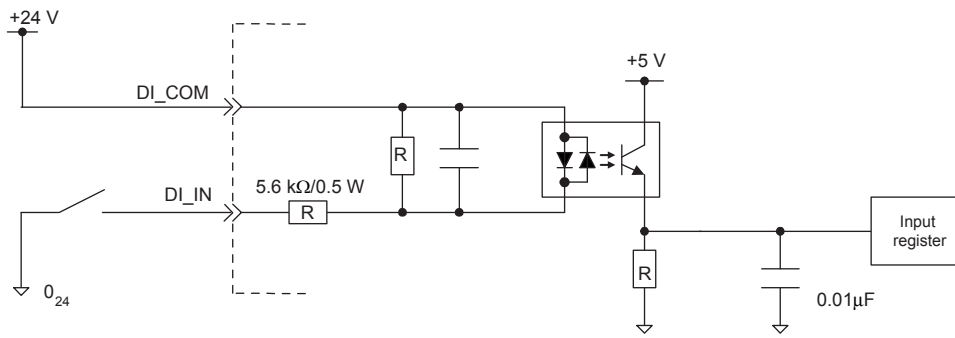

Fig. 3.1 Digital Input Circuit (Sink Mode Input)

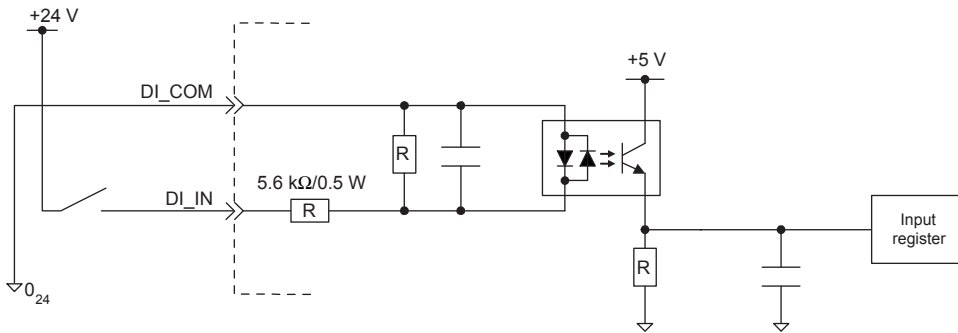

Fig. 3.2 Digital Input Circuit (Source Mode Input)

(6) Output Circuit

The following table shows the CPU I/O Connector output circuit specifications.

Item	Specifications
Outputs	4 points
Output Format	Transistor, open-collector, sink mode output
Isolation Method	Photocoupler
Output Voltage	+24 VDC $\pm 20\%$
Output Current	100 mA max.
Leakage Current When OFF	0.1 mA max.
ON Time/OFF Time	ON: 1 ms max. OFF: 1 ms max.
Number of Commons	1 (4 points/common)
Protection Circuit	Fuse <ul style="list-style-type: none"> The fuse is not, however, for circuit protection. It is for protecting against fire at output shorts. Attach a fuse externally to each output if circuit protection is required.

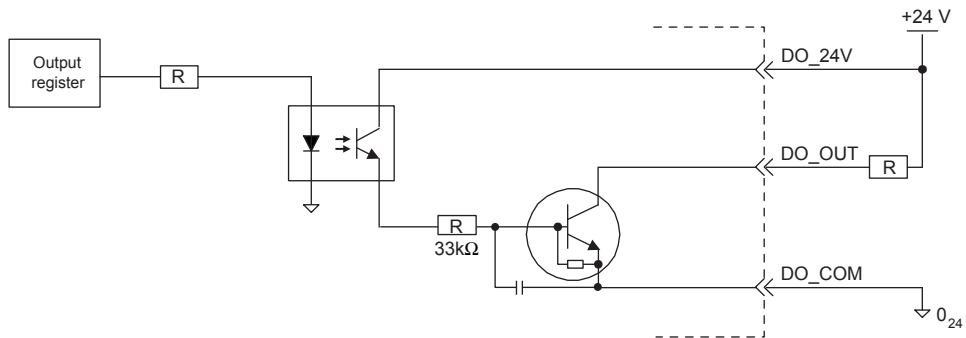
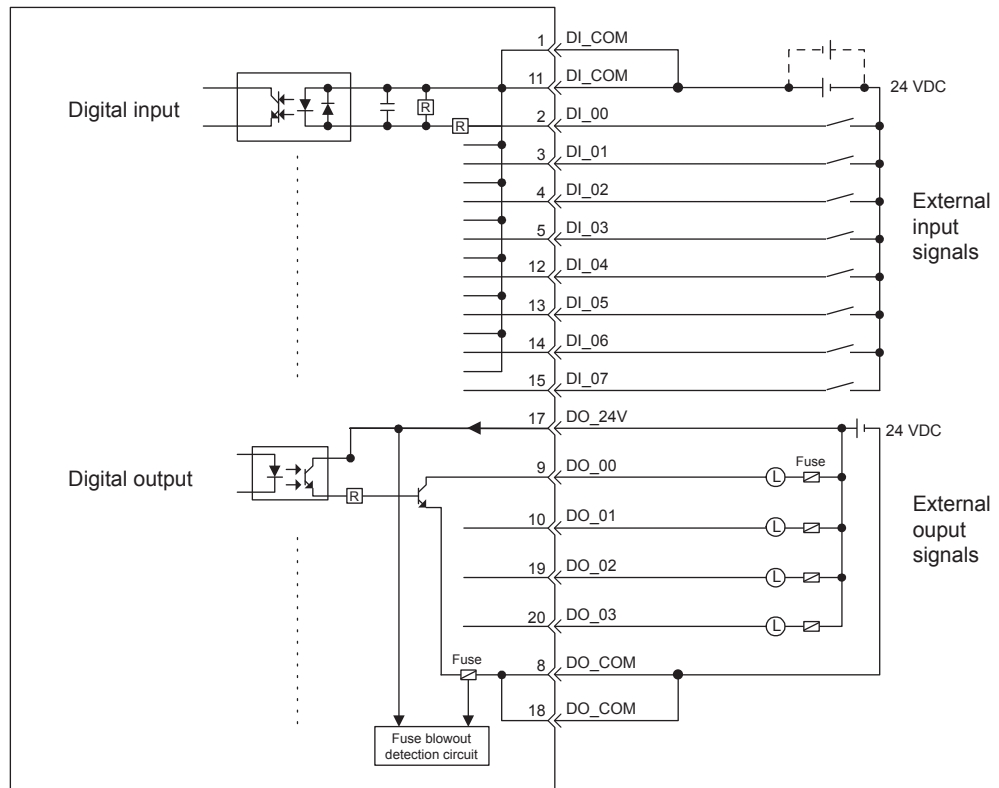

Fig. 3.3 Digital Output Circuit (Sink Mode Output)

(7) CPU I/O Connector Connections

The following diagram shows the connections for the CPU I/O connector.



- Connect a fuse suitable for the load specifications in the output signal circuit in series with the load. If an external fuse is not connected, load shorts or overloads could result in fire, destruction of the load device, or damage to the output element.
- The pins 1 and 11 and the pins 8 and 18 are internally connected. Connect them externally as well.

System Startup and Sample Programs

This chapter describes the procedure for starting the MP2300 system and sample programs for typical operation and control.

4.1 Model System Startup Procedure	4-2
4.1.1 Flowchart for Model System Startup	4-2
4.1.2 System Configuration	4-3
4.1.3 Initializing SERVOPACKs	4-5
4.1.4 Setting and Saving Communication Process (Communication Manager)	4-6
4.1.5 MP2300 Self-configuration	4-12
4.2 Starting the Sample Program - MPE720 Ver 6.□□	4-13
4.2.1 Copying and Transferring Sample Program Files	4-13
4.2.2 Setting Motion Fixed Parameters and Adjusting the Settings for Servo Control	4-17
4.2.3 Saving Data from the MP2300 to Flash Memory, and Transferring Data to Your Computer from the MP2300	4-21
4.3 Starting Sample Program - MPE720 Ver 5.□□	4-23
4.3.1 Starting MPE720 Ver 5.□□ and Creating Folders	4-24
4.3.2 Reading Sample Programs and Setting and Saving Parameters	4-28
4.3.3 Other Operations	4-42
4.4 Checking Sample Program Operation	4-44
4.4.1 How to Open the Tuning Panel Window	4-44
4.4.2 Operation Check 1: Manual Operation	4-46
4.4.3 Operation Check 2: Position Control	4-53
4.4.4 Operation Check 3: Phase Control - Electronic Shaft	4-58
4.4.5 Operation Check 4: Phase Control - Electronic Cam	4-62
4.5 System Startup Using Self-Configuration	4-68
4.5.1 Starting the System for First Time	4-68
4.5.2 System Startup when Adding Electronic Devices	4-71
4.5.3 System Startup when Replacing Electronic Devices	4-73

4.1 Model System Startup Procedure

This section describes the procedure for starting the Model System and using the sample programs of the MPE720 Programming Tool (on the MPE720 installation disk). The procedure for designing machine systems is omitted here.

4.1.1 Flowchart for Model System Startup

An outline of the procedure for system startup is provided below.

The procedure differs in steps 7 and 8, depending on the MPE720 version.

Refer to the reference material for each procedure, indicated in the right-hand column.

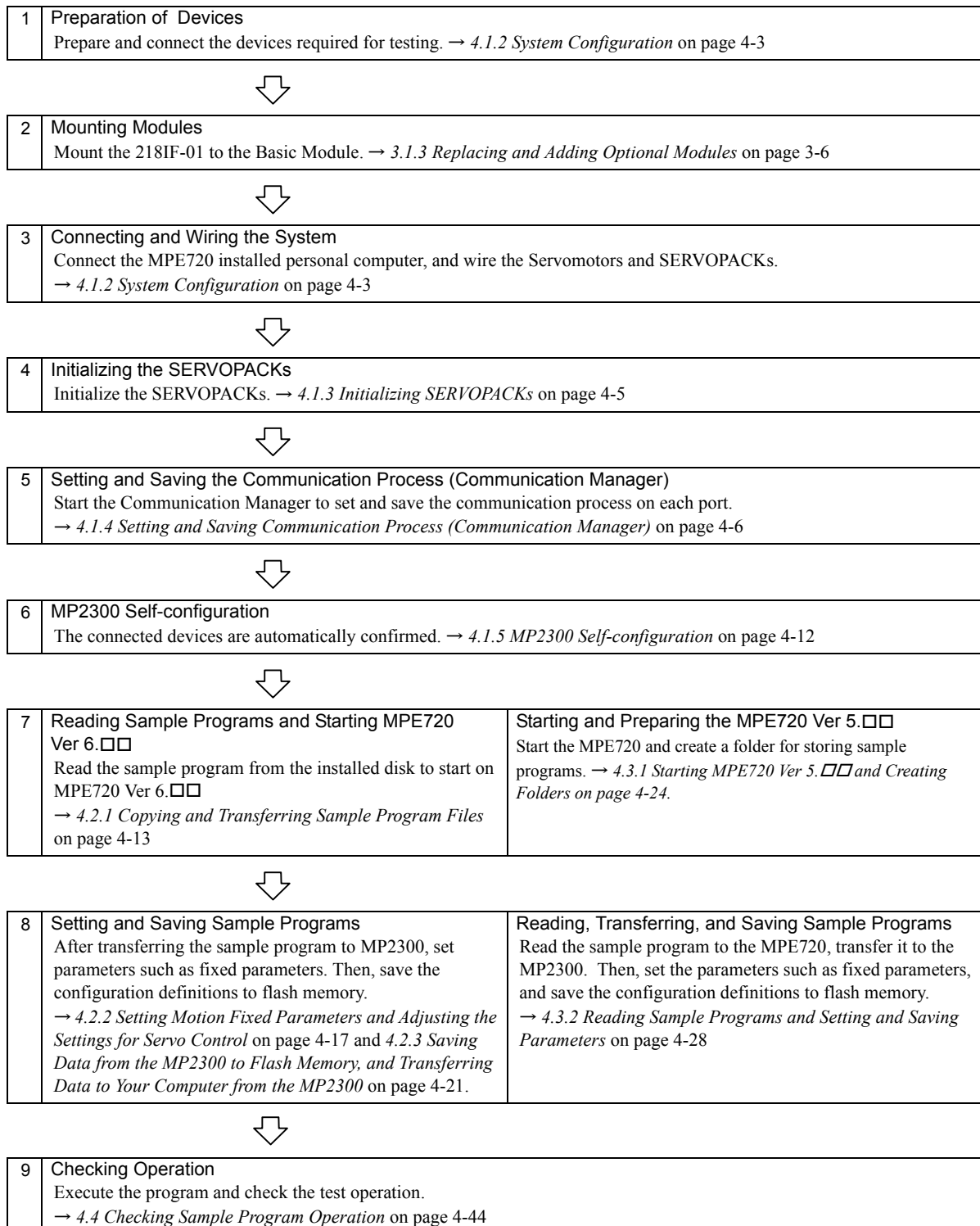

4.1.2 System Configuration

This section describes the system configuration shown in the following diagram. Prepare each device and connect as diagram.

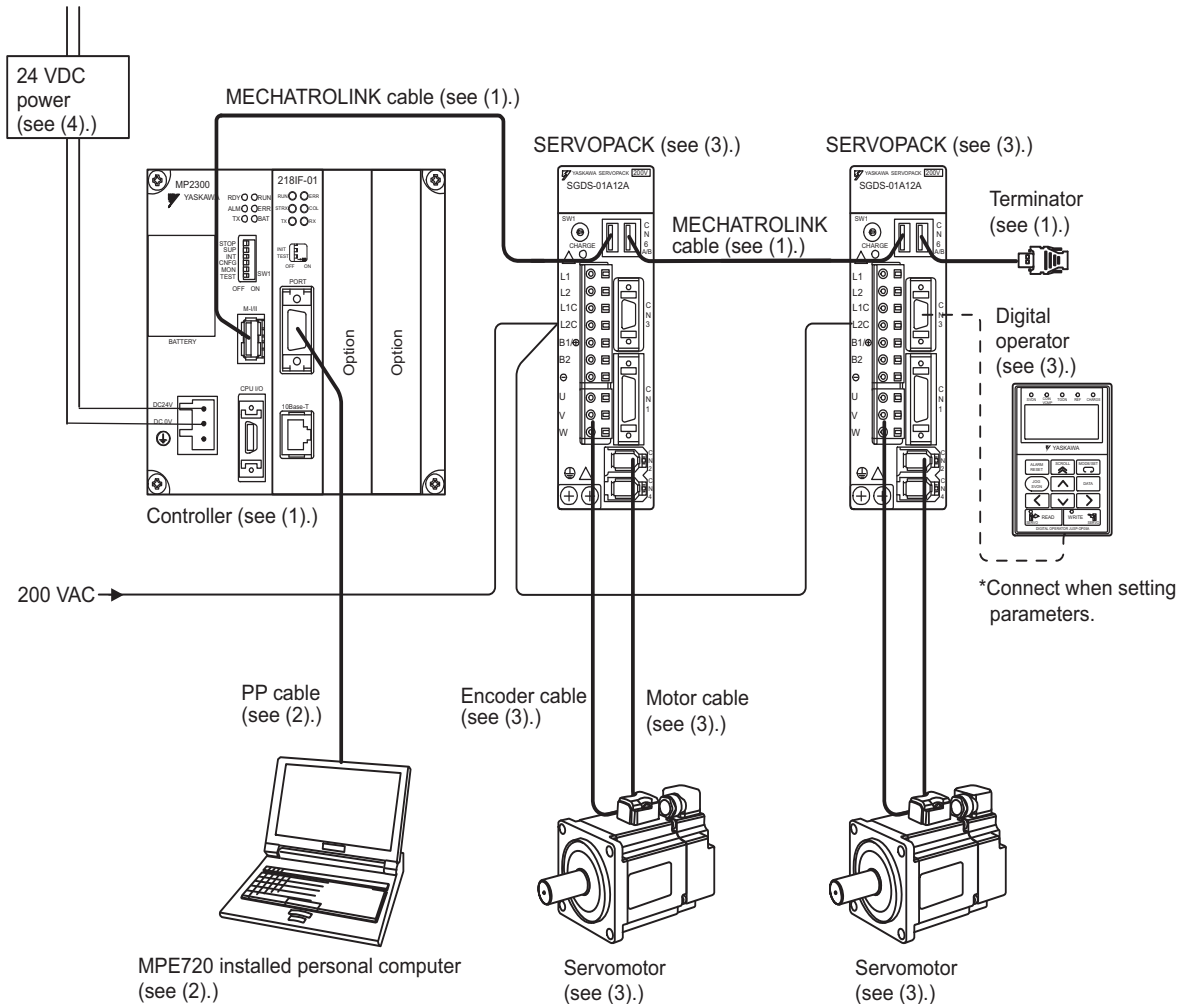

For details on equipment for the controller, programming device, servodrive, and the power supply, refer to the following descriptions.

(1) Controller-related Equipment

Name	Model	Quantity
MP2300	JEPMC-MP2300	1
218IF-01	JAPMC-CM2300	1
MECHATROLINK Cables (1 m)	JEPMC-W6002-01	2
Terminator	JEPMC-W6022	1

- For mounting the 218IF-01 Module to the MP2300, refer to 3.1.3 Replacing and Adding Optional Modules on page 3-6.

(2) Programming Device-related Equipment

Name	Model	Quantity
MPE720	CPMC-MPE720 version 4.41A or later CPMC-MPE770 version 6.0 or later	1
PP Cable (for RS-232C connection)	JEPMC-W5311-03	1
PP Cable (for Ethernet connection)	Commercially-available cross cable	1
Computer	Commercially-available product	1

- Above equipments can connect to the MP2300 with either RS-232C or Ethernet.

(3) Servodrive-related Equipment

Name	Model	Quantity
Σ -III SERVOPACKs	SGDS-01A12A	2
Σ -III Servomotors	SGMAS-01ACA21	2
Motor Cables (3 m)	JZSP-CSM01-03	2
Encoder Cables (3 m)	JZSP-CSP01-03	2
Digital Operator	JUSP-OP05A	1



- The sample program settings control operation for station 1 and 2 axes, so the MECHATROLINK station numbers must be set to 1 and 2 on the SERVOPACK rotary switches.
- Open the front cover of the SERVOPACK and set the DIP switch inside as follows: Pin 1: ON; Pin 2: ON; Pin 3: OFF; Pin 4: OFF.
- When making SERVOPACK settings, the Digital Operator is connected to the SERVOPACK for which settings are to be made.

(4) Other Required Equipment

Name	Specification	Quantity
24-VDC power supply	Current capacity of 2 A or larger	1

4.1.3 Initializing SERVOPACKs

This section describes the procedure for initializing Σ -III SERVOPACKs using the Digital Operator. Always initialize SERVOPACKs that have been transferred from other systems. SERVOPACKs that are being used for the first time do not need to be initialized.

1. Check that the SERVOPACK power is OFF and then insert the Digital Operation connection plug into the CN3 connector on the SERVOPACK.
2. Turn ON the SERVOPACK control power and main power.
3. Turn ON the Digital Operator power.
4. Press the  Key on the Digital Operator to display the Auxiliary Function Mode main menu, and use the   Keys to select Fn005.

```

BB          - F U N C T I O N -
Fn004
Fn005
Fn006
Fn007
  
```

5. Press the  Key to switch to the Fn005 parameter initialization execution display.

* If the display does not change and "NO-OP" is displayed on the status display, a Write Prohibited password has been set using Fn010 and the user settings cannot be initialized. Clear the write protection and execute the operation again.



6. Press the  Key again and execute Fn005.

"Parameter Init" will flash during initialization.

```

BB
Parameter Init
Start : [DATA]
Return : [SET]
  
```

The flashing will stop when initialization has been completed and the status display will change from BB to Done to A.941.

- To cancel initialization, press the  Key before pressing the  Key. The display returns to the Auxiliary Function Mode main menu.

7. Turn the SERVOPACK control and main power supplies from OFF to ON to enable the initialization.

4.1.4 Setting and Saving Communication Process (Communication Manager)

Use the following procedure to set the communication process between the personal computer (MPE720) and the MP2300 using the Communication Manager. These settings are not required if the communication settings have already been made.

1. Open the YE_Applications Folder and double-click the **Communication Manager** Icon in the YE_Applications Folder. Or, Click **Start - All Programs - YE_Applications - Communication Manager** to start the Communication Manager.

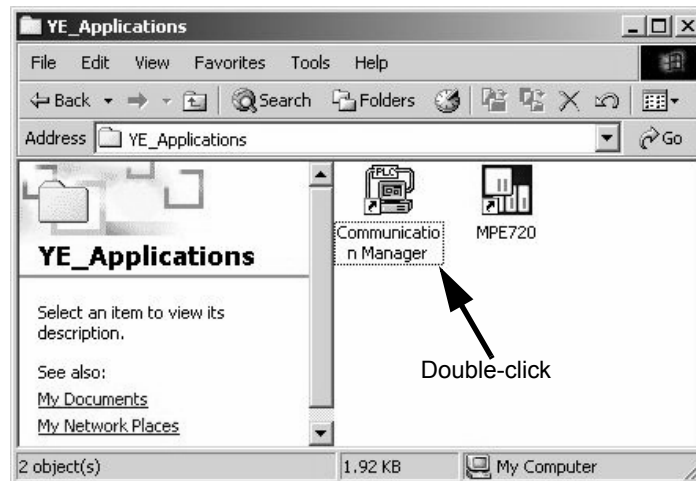

The **Communication Process** Icon appears on the task tray at the bottom right of the screen (version 5.30 or later).

2. Double-click the **Communication Process** Icon on the task tray to open the **Communication Process** Window.



Communication Process Icon

In this section, Logical PT number **1** is assigned for RS-232C connection and **2** for Ethernet connection in the **Communication Process** Window.

■ Settings for RS-232C Connection

3. Double-click Logical PT number **1** in the **Communication Process** Window to display the **Logical Port Setting** Window.

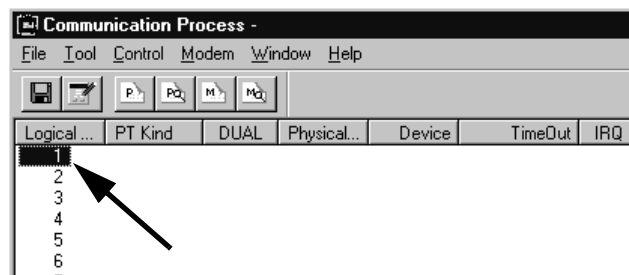

The **Logical Port Setting** Window appears.

- For RS-232C connections, select **Serial** under Port Kind and then click **Detail** Button in the **Logical Port Setting** Dialog Box.

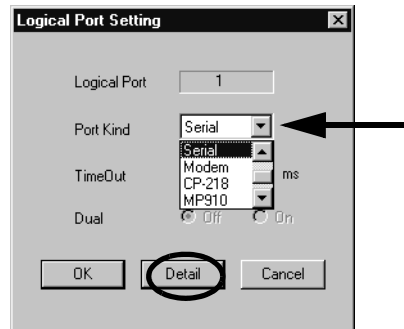

The **Serial Port Setting** Dialog Box appears.

- Match the settings under Physical Port to the computer's serial communication port. Leave the other items on the default settings. Once the settings have been completed and checked, click the **OK** Button to close the **Logical Port Setting** Dialog Box.

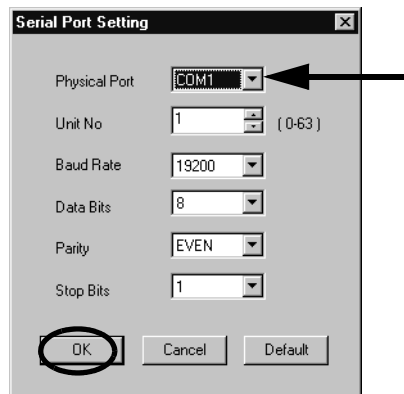

- The **Logical Port Setting** Window appears. Click the **OK** Button again. The screen will return to the **Communication Process** Window. Check that **Serial** has been allocated to Logical PT number 1.

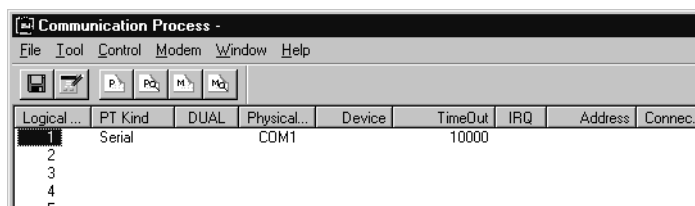

■ Settings for Ethernet Connection

Prior to make settings for Ethernet connection, the IP address of the personal computer must be set. Use the following procedure to set the IP address and make settings for Ethernet connection.

- Make the following settings with the LAN cable connected.

7. Click **Start - Settings - Control Panel - Internet Options**.

The **Internet Properties** Window appears.

8. Click **Connection** Tab to display the page. Click **LAN settings**.

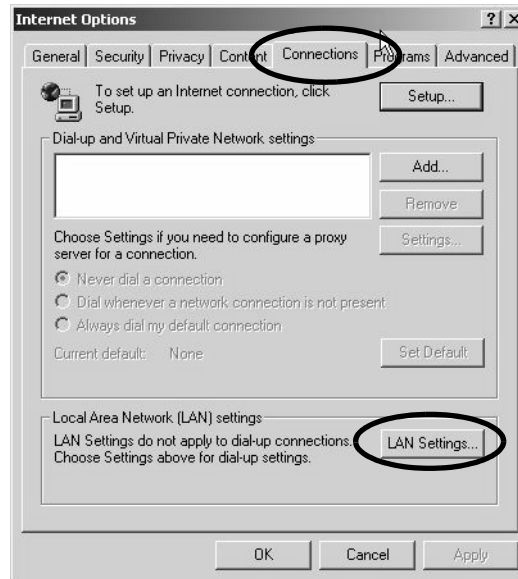

The **Local Area Network (LAN) Settings** Dialog Box appears.

9. Check if the **Automatically detect the settings** Check Box is cleared and click the **OK** Button to close the dialog box.

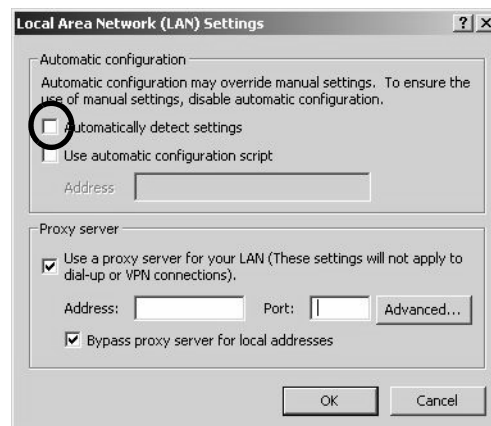

10. For a computer running Windows 2000 OS, click the **Start** Button and select **Settings - Control Panel - Network and dial-up connection**.

For a computer running Windows XP OS, click the **Start** Button and select **Settings - Control Panel - Network connection**.

On the computer running Windows 2000 OS, the **Network and dial-up connection** Window will be displayed, and on the computer running Windows XP OS, the **Network connection** Window.

11. For the computer running Windows 2000 OS, double-click the **Local area connection** Icon. For the computer running Windows XP OS, select **Local area connection** and click **Change settings of this connection** in the Network Task field.

< Windows 2000 running computer >

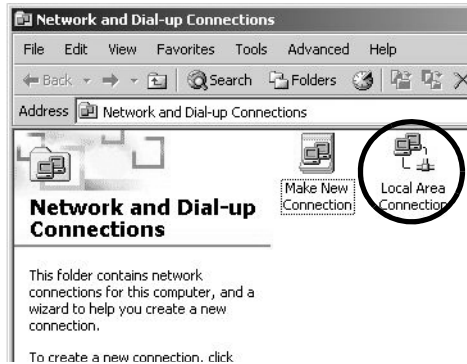

< Windows XP running computer >

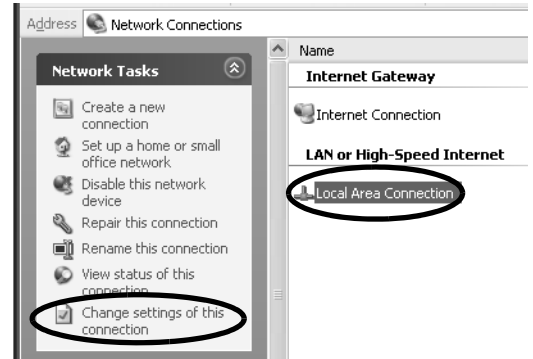

The **Property for Local area connection** Dialog Box appears.

12. Select **Internet Protocol (TCP/IP)** and click the **Properties** Button.

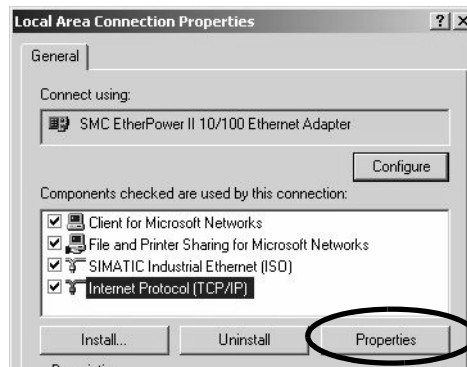

The **Internet protocol (TCP/IP) Properties** Dialog Box appears.

13. Click the **Use the following IP address** Option Button and enter 192 168 1 2 under IP Address and 255 255 255 0 under Subnet Mask. Click the **OK** Button to close the dialog box.

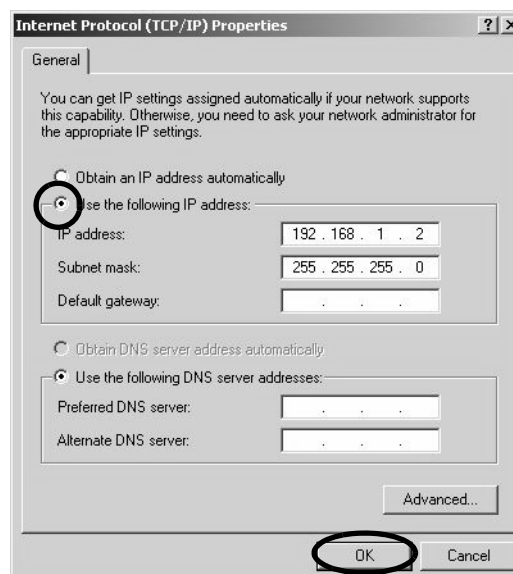

14. Double-click Logical Port No. 2 in the **Communication Process** Window to display the **Logical Port Setting** Dialog Box.

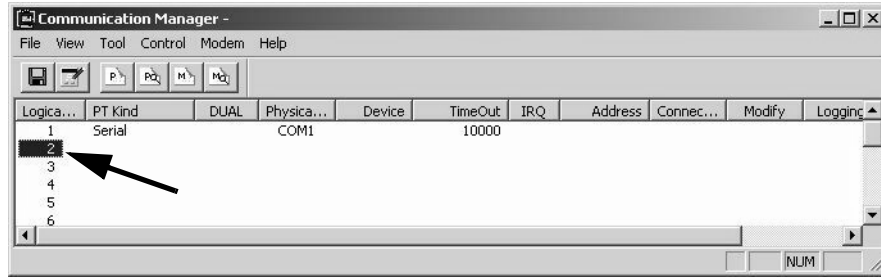

15. Select **CP-218** under Port Kind in the **Logical Port Setting** Dialog Box and click the **Detail** Button.

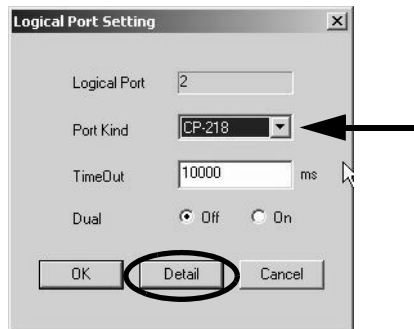

The **CP-218 Port Setting** Dialog Box appears.

16. Enter the IP address of computer and click **OFF** for Default. Leave the other items on their default settings. Click the **OK** Button to close the dialog box.

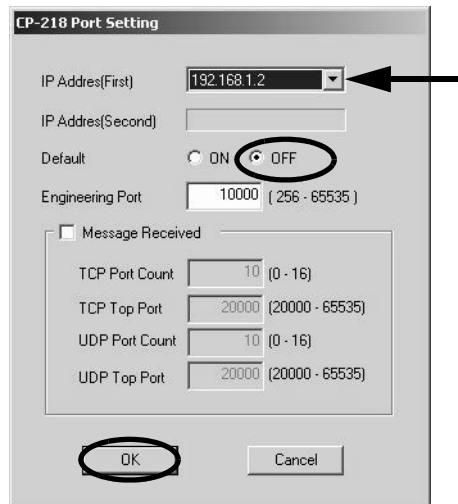

17. Click the **OK** Button in the **Logical Port Setting** Dialog Box to return to the **Communication Process** Window. Check to see if the **CP-218** (Ethernet connection) is assigned to the Logical Port No. 2.

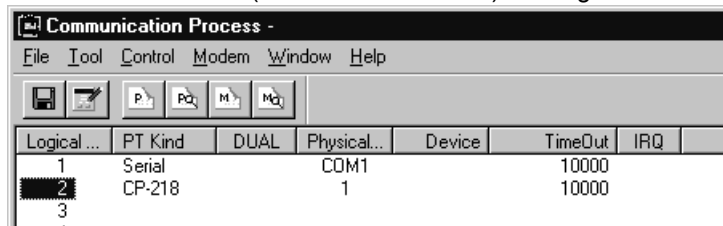

■ Saving the Communication Port Settings and Restarting **Communication Process** Window

18. Click **File - Save**. A save confirmation window will be displayed. Click the **Yes** Button to save the communication port settings.



These settings will be used as the communication port information whenever the communication process is started.

19. Exit the **Communication Process** Window and restart to validate the settings. Select **File - Exit** to close the **Communication Process** Window. The confirmation message will be displayed. Click the **Yes** Button to close the **Communication Process** Window.

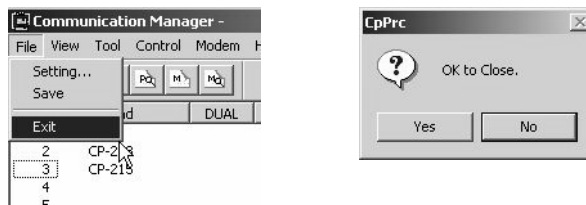

20. Double-click the **Communication Manager** Icon in the YE_Application Folder to reopen the **Communication Process** Window.

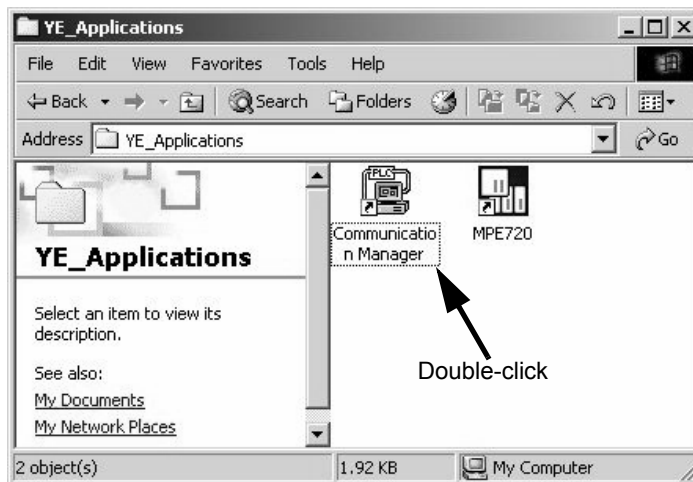

4.1.5 MP2300 Self-configuration

Execute self-configuration to automatically configure the Optional Modules mounted to the Basic Module and the devices connected to the MECHATROLINK.

This section explains the method for self-configuration.

1. Check that the power supply of the Σ -III SERVOPACK is ON.
2. Turn OFF the 24-VDC power supply to the MP2300.
3. Turn ON the INIT and CNFG switches on the DIP switch (SW1) on the MP2300 Basic Module.

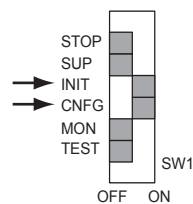

4. Turn ON the 24-VDC power supply to the MP2300.
Check that the LED indicators on the MP2300 Basic Module change as the following illustration.



5. Turn OFF the INIT and CNFG switches on the DIP switch (SW1) on the MP2300 Basic Module.

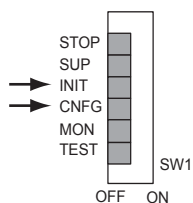

This completes the self-configuration, and the information of Optional Modules and MECHATROLINK slave devices are read in the definition information file.

■ Power Restart and RAM data Clear

If the INIT switch on the DIP switch on the Basic Module is ON and the power is turned ON, RAM data will be cleared.

Also, flash memory data will be read and RAM data will be overwritten when the INIT switch is OFF and the power is turned ON. In either case, the RAM data will be cleared by turning the power ON. Therefore, always save data to the MP2300 flash memory before turning OFF the power when writing or editing programs.

For information on how to save data to flash memory, refer to 4.2.3 (1) *Saving to Flash Memory* on page 4-21 (MPE720 Ver 6.□□) or 4.3.2 (6) *Saving to Flash Memory* on page 4-40 (MPE720 Ver 5.□□).

■ Turning OFF Power after Executing Self-configuration

Do not turn OFF the 24-VDC power supply to the MP2300 after executing self-configuration until the definitions data has been saved to flash memory in the MP2300. If the power is turned OFF somehow before the data is saved to flash memory, execute self-configuration again.

4.2 Starting the Sample Program - MPE720 Ver 6.□□

This section describes how to copy the sample program file from MPE720 Ver 6.□□ installation disk, how to start MPE720 Ver 6.□□ to transfer the sample program to the MP2300, and how to set and save parameters, according to the following flowchart.

The descriptions assume that the MPE720 is already installed on your computer.

1	Copy the sample program file onto the hard disk of your computer from the installation disk contained in the CD-ROM.	→ 4.2.1 (1) Copying the Sample Program File on page 4-13
↓		
2	Start MPE720 Ver 6.□□ and transfer the sample program file to the MP2300.	→ 4.2.1 (2) Starting MPE720 Ver 6.□□ To Transfer the Sample Program to the MP2300 on page 4-14
↓		
3	Open the SVB Definition Window to set and save the motion fixed parameters.	→ 4.2.2 (1) Setting and Saving Motion Fixed Parameters on page 4-17
↓		
4	Adjust and save the SERVOPACK parameters.	→ 4.2.2 (2) Making Servo Adjustments and Saving SERVOPACK Parameters on page 4-19
↓		
5	Save the parameter settings stored in the MP2300 RAM to the flash memory.	→ 4.2.3 (1) Saving to Flash Memory on page 4-21
↓		
6	Transfer the MP2300 data to your computer.	→ 4.2.3 (2) Transferring Data from the MP2300 to Your Computer on page 4-22

4.2.1 Copying and Transferring Sample Program Files

Use the following procedure to copy the sample program files from the installation disk to the hard disk of your computer, start MPE720 Ver 6.□□, and transfer the file to the MP2300.

(1) Copying the Sample Program File

1. Insert the MPE720 Ver 6.□□ installation disk into the CD-ROM drive on your computer.
The installation window will automatically start running. Click the **Cancel** Button to cancel the autorun.
2. Open the My Computer folder, and then right-click the **MPE720V6** disk drive. Click **Open** in the pop-up menu that appears.

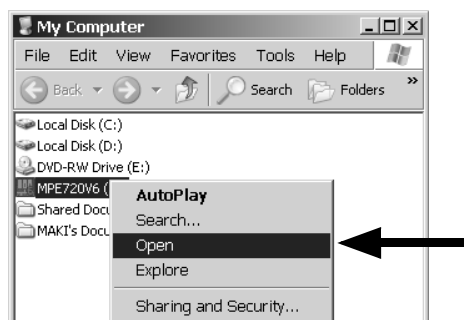

The root directory of the installation disk will be displayed.

4.2.1 Copying and Transferring Sample Program Files

3. Open the **Sample** folder, and then open the **ENG** folder inside the **Sample** folder to display the sample program files.

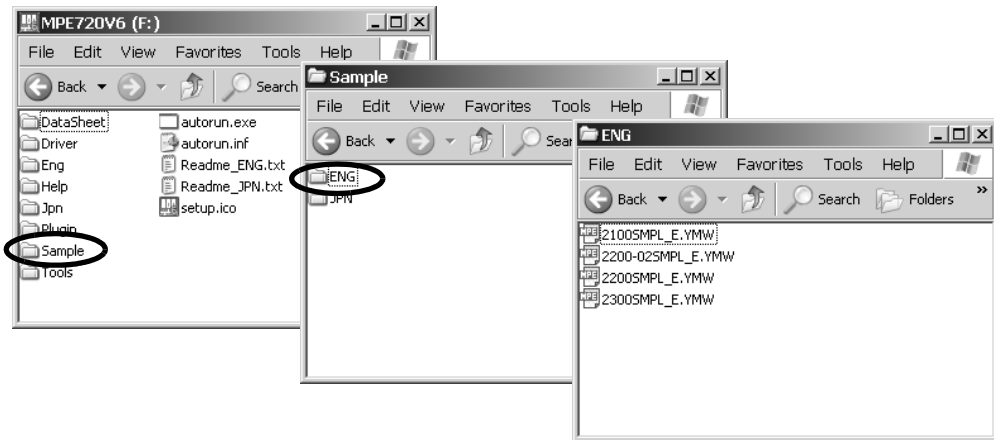

4. Copy the sample program file **2300SMPL_E.YMW**, and paste it in a folder in the hard disk.

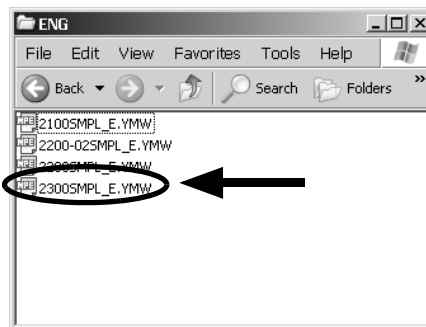

(2) Starting MPE720 Ver 6.□□ To Transfer the Sample Program to the MP2300

1. Double-click the **2300SMPL_E.YMW** file copied to the hard disk.

MPE720 Ver 6.□□ will start up and the following message will ask for confirmation to connect to the controller. Click the **No** Button.

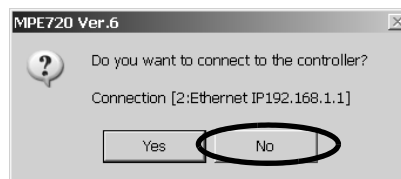

2. Click **Communications Setting** in the MPE720 Ver 6.□□ main window.

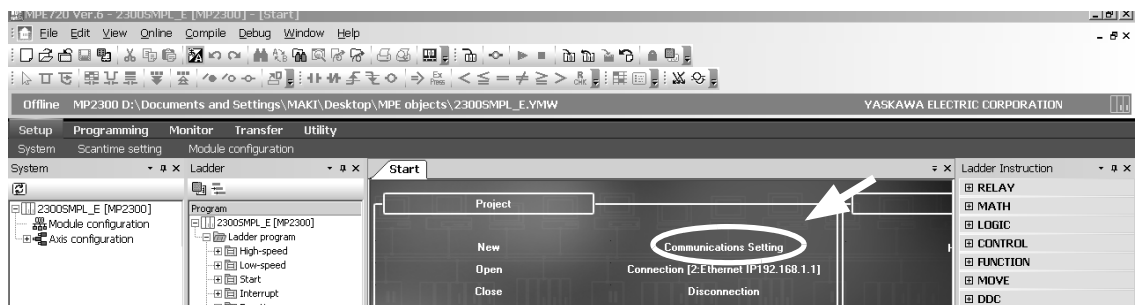

The **Communications Setting** Dialog Box will appear.

3. Click the ▼ Button, and select a port to be used for communications with the MP2300 from the drop-down list box. Then, click the **Connection** Button.
 - ♦ In the drop-down list box, the details of each port set in the procedure described in 4.1.4 *Setting and Saving Communication Process (Communication Manager)* on page 4-6 will be displayed.

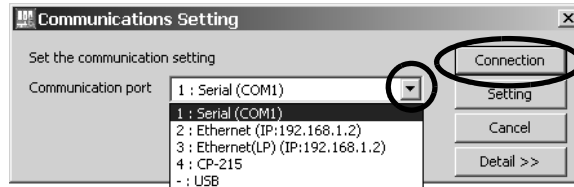

The MP2300 and your computer will be connected online.

4. Select **Online - Write into Controller** in the menu bar.

The **Transfer Program - Write into Controller** Dialog Box will appear.

5. Click the **Individual** Button to select an individual file transfer, and click the **Save to flash after transferring to the controller** Check Box to clear it. Then, select the **System Configuration** Check Box. Select the **Scan time definition** and **Data trace** Check Boxes from the list of files that will be displayed on the right.

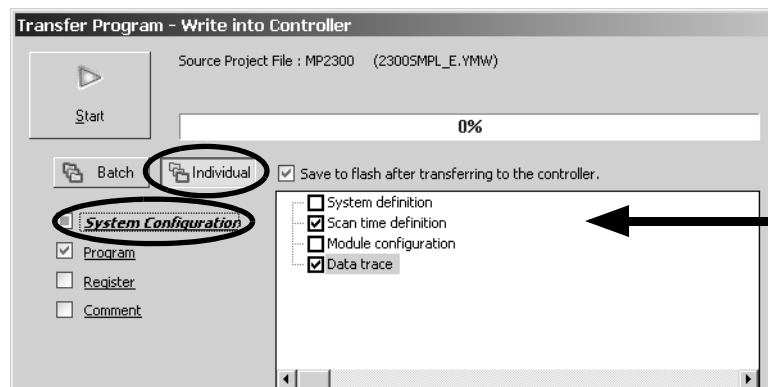

6. Select the **Program** Check Box. Then, select the **Ladder program**, **Main program** and **Group definition** Check Boxes under **Motion Program**. Click the **Start** Button.

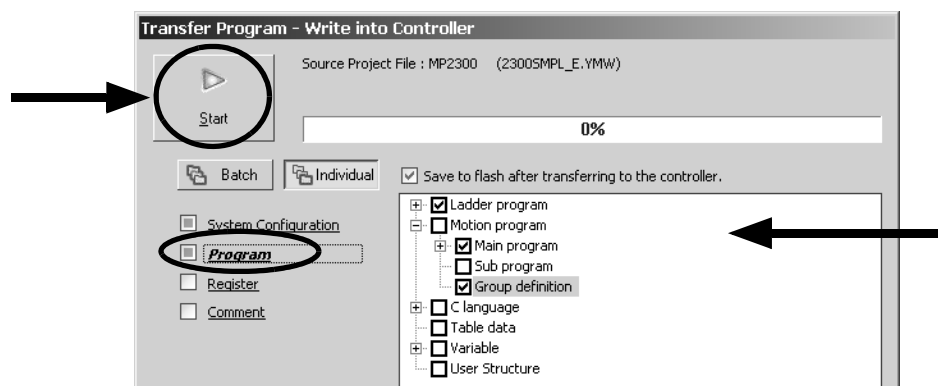

A message box will appear and ask whether or not to stop the MP2300 to allow transfer of the files.

7. Click the **CPU STOP** Button.

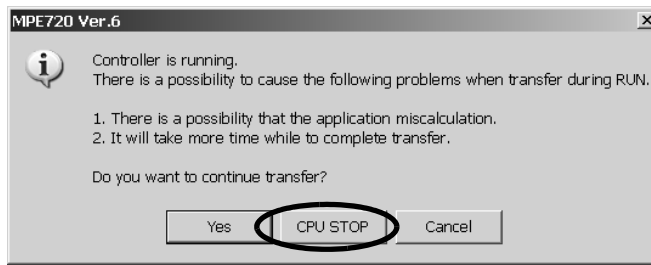

The MP2300 will stop running and MPE720 will start transferring the selected sample program files. When the transfer is complete, a message box will appear to tell you that the sample program files have been successfully written to the MP2300.

8. Click the **OK** Button in the message box. Another message box will appear asking whether or not to run the MP2300. Click the **Yes** Button to run the MP2300.

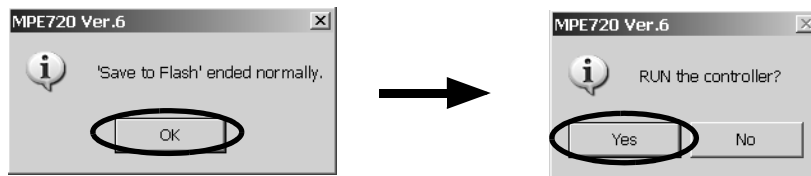

The MP2300 will start running.

The sample program files have been transferred to the MP2300.

4.2.2 Setting Motion Fixed Parameters and Adjusting the Settings for Servo Control

(1) Setting and Saving Motion Fixed Parameters

This section describes how to set and save MP2300 motion fixed parameters for Axes 1 and 2 according to the sample program.

- To use the program, set the motion fixed parameters according to the connected system. For details regarding the motion fixed parameters, refer to *Machine Controller MP2000 Series Built-in SVB/SVB-01 Motion Modules User's Manual* (Manual No.: SIEPC88070033).

1. Select **Setup - Module configuration** from the Launcher. Alternatively, double-click **Module configuration** in the **2300SMPL_E** folder in the system sub programs.

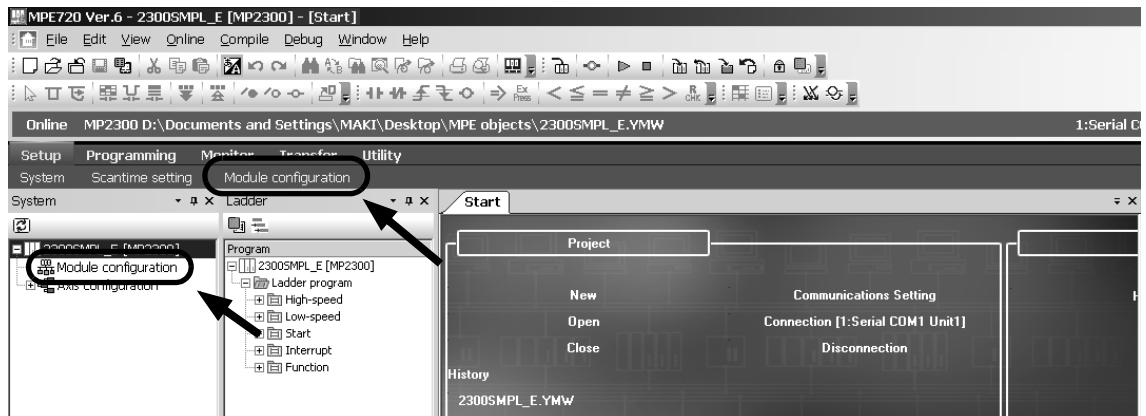

The Engineering Manager will start, and the **Module Configuration** Window will open.

2. Select **00** in the **Controller Area** and double-click the **3** in the **Module Details MP2300 SLOT≠00** Area in the **Module Configuration** Window.

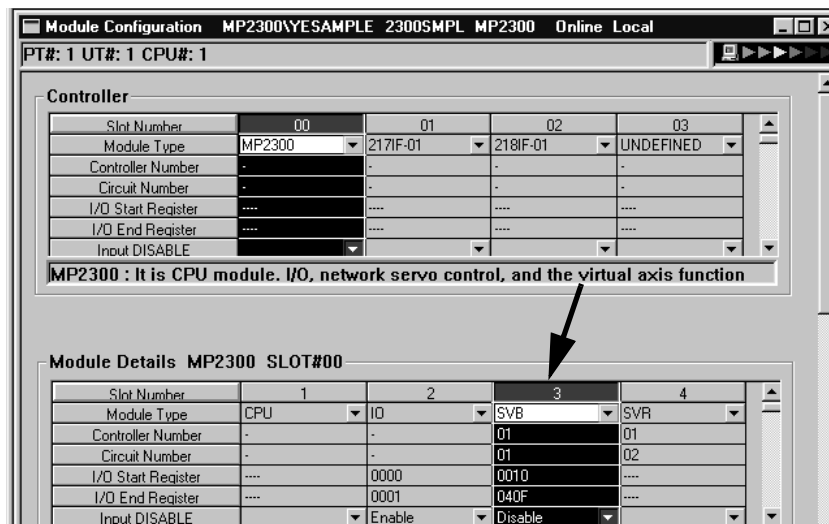

The **SVB Definition** Window with **Fixed Parameters** Tab Page will appear.

3. Set the fixed parameters for axis 1.

Select *Axis 1* from the axis selection box at the top-left of the window and select *mm* under **No. 4 Reference unit selection** on the **Fixed Parameters** Tab Page.

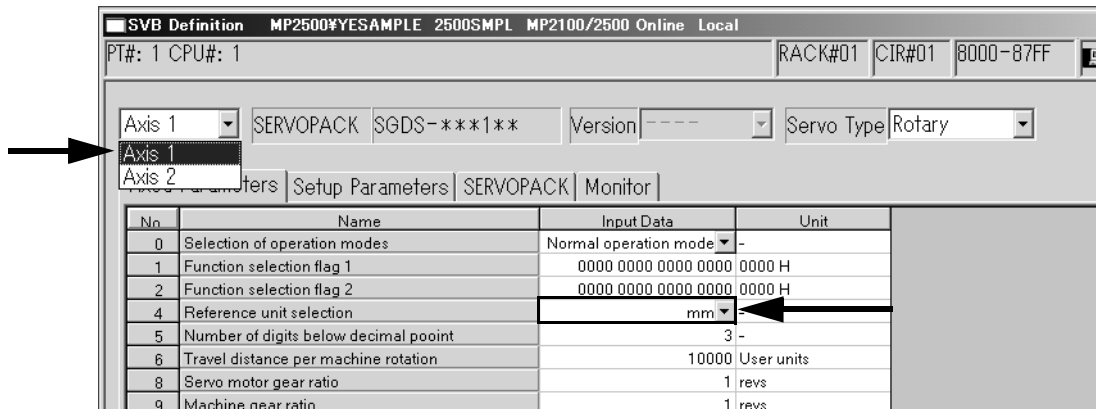

4. In the **Engineering Manager** Window, select **File - Save** to save the settings for axis 1 fixed parameters.

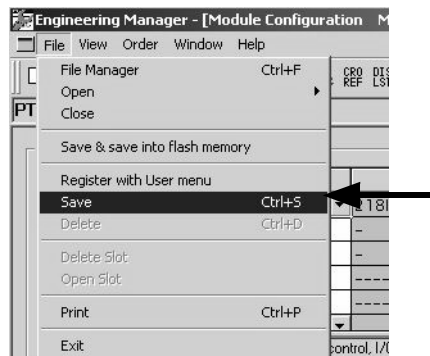

5. Follow steps 3 and 4 to set and save the fixed parameters for axis 2 as well.

The process for saving fixed parameter settings has now been completed. Next, save the SERVOPACK parameters.

(2) Making Servo Adjustments and Saving SERVOPACK Parameters

This section describes how to make Servo adjustments and save the SERVOPACK parameters for each axis to the MP2300.

1. Execute servo gain and other adjustments for each Servo.
 - Refer to each SERVOPACK manual for information on the Servo adjustments.
2. Select the axis in the **SVB Definition Window**, then click the **SERVOPACK** Tab to display the **SERVOPACK Tab Page**.

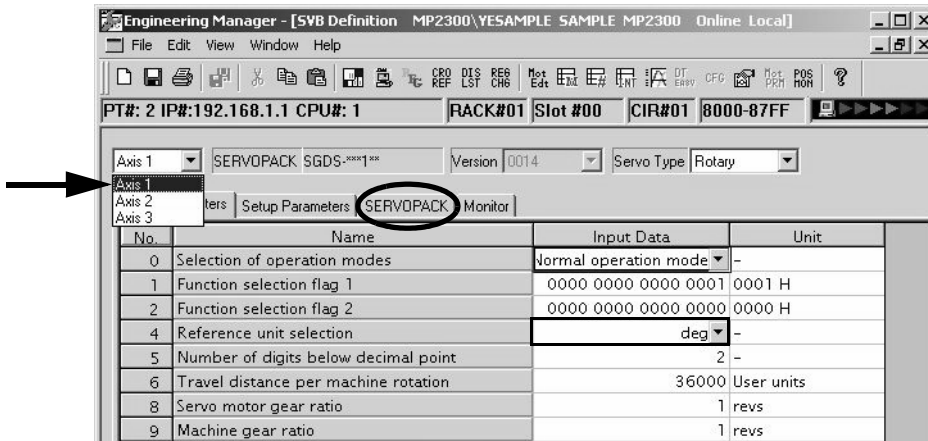

3. Select **Edit - Copy Current Value**.

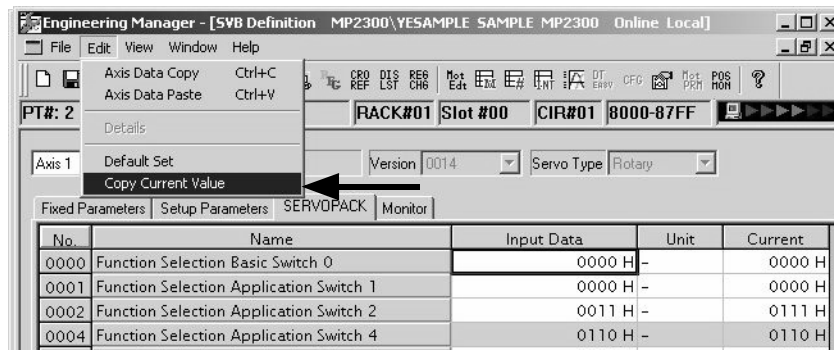

A confirmation dialog box will appear.

- The data in the **Input Data** Column is the SERVOPACK data saved to the MP2300 and the data in the **Current Value** Column is the data set to the SERVOPACK.
 - Refer to *B Current Values and Set Values (Input Data) in the SVB Definition Window* on page A-5 for information on the relationship between *Current Value* and *Setting Data*.
4. Click the **Yes** Button in the confirmation dialog box to write the SERVOPACK data (current position) as the MP2300 settings data.

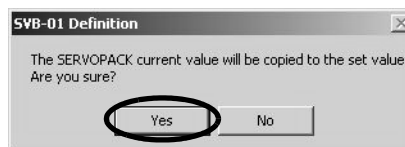

5. Select **File - Save** to save the SERVOPACK settings for axis 1 to the MP2300.

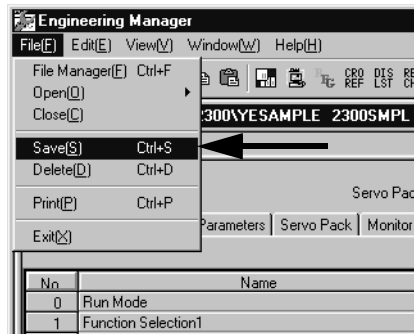

6. Follow steps 2 to 5 to write and save the SERVOPACK current position for axis 2 as settings data as well.
7. Select **File - Exit** to exit the setting and saving process in the **Engineering Manger** Window.

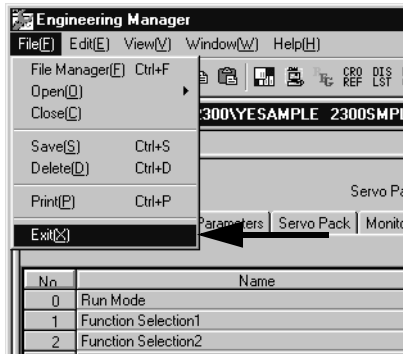

4.2.3 Saving Data from the MP2300 to Flash Memory, and Transferring Data to Your Computer from the MP2300

Save the data stored in the MP2300, including the module configuration files that have been automatically created by executing the self-configuration function and the edited program files, to the flash memory, and transfer it to your computer to synchronize the data stored in the MP2300 with the data stored in your computer.

(1) Saving to Flash Memory

Use the following procedure to save the data from the MP2300 RAM to flash memory.

1. Select **Online - Save to Flash** in the menu bar of the MPE720 Ver 6.□□ main window.

The **Transfer Program - Save to Flash** Dialog Box will appear.

2. Check to see that the target controller displayed in the dialog box is correct, and then click the **Start** Button.

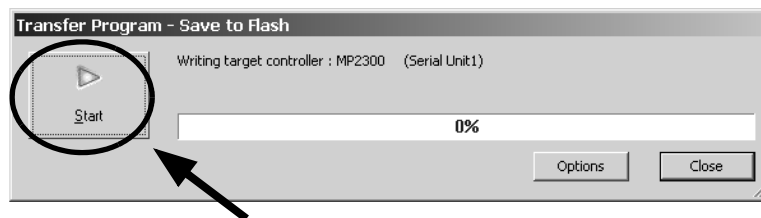

A message box will appear and ask whether or not to stop the MP2300 while saving data to the flash memory.

3. Click the **NO** Button to stop the MP2300 and start saving the data to the flash memory.

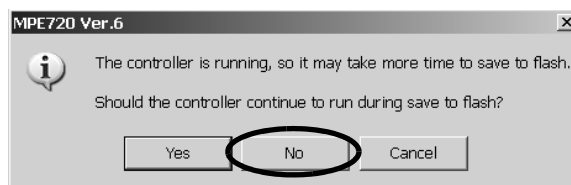

When the data has been successfully saved in the flash memory, a message box will appear to inform you that saving process is complete.

4. Click the **OK** Button in the message box. Another message box will appear asking whether or not to run the MP2300. Click the **Yes** Button to run the MP2300.

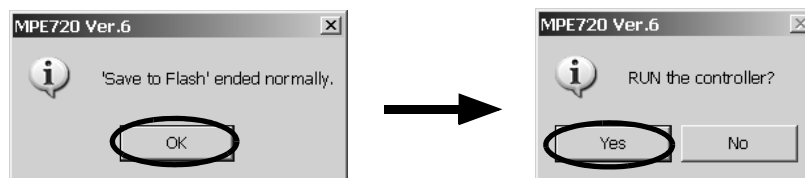

The data has been saved in the flash memory.

(2) Transferring Data from the MP2300 to Your Computer

Use the following procedure to transfer data from the MP2300 RAM to a computer.

1. Select **Online - Read from Controller** from the menu bar of the MPE720 Ver 6.□□ main window.
The **Transfer Program - Read from Controller** Dialog Box will appear.
2. Check the selected items and displayed contents to see if they are correct, and then click the **Start** Button.

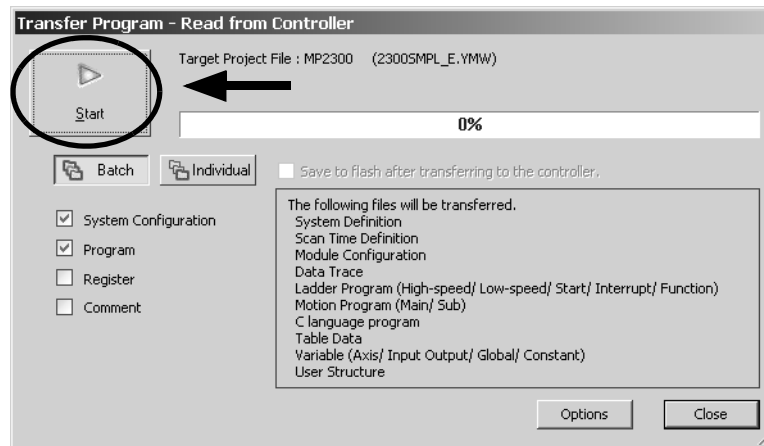

The project file (sample file) saved in your computer will be overwritten with the data transferred from the MP2300. When the overwriting is complete, a message box will appear to inform you.

3. Click the **OK** Button. Data transfer from the MP2300 to the computer will end.

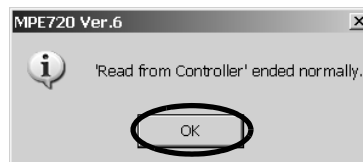

4.3 Starting Sample Program - MPE720 Ver 5.□□

The following flowchart describes the method used for reading the sample program from the installation disk of MPE720 Ver 5.□□, and for setting and saving parameters after starting the MP2300 using MPE720 Ver 5□□.

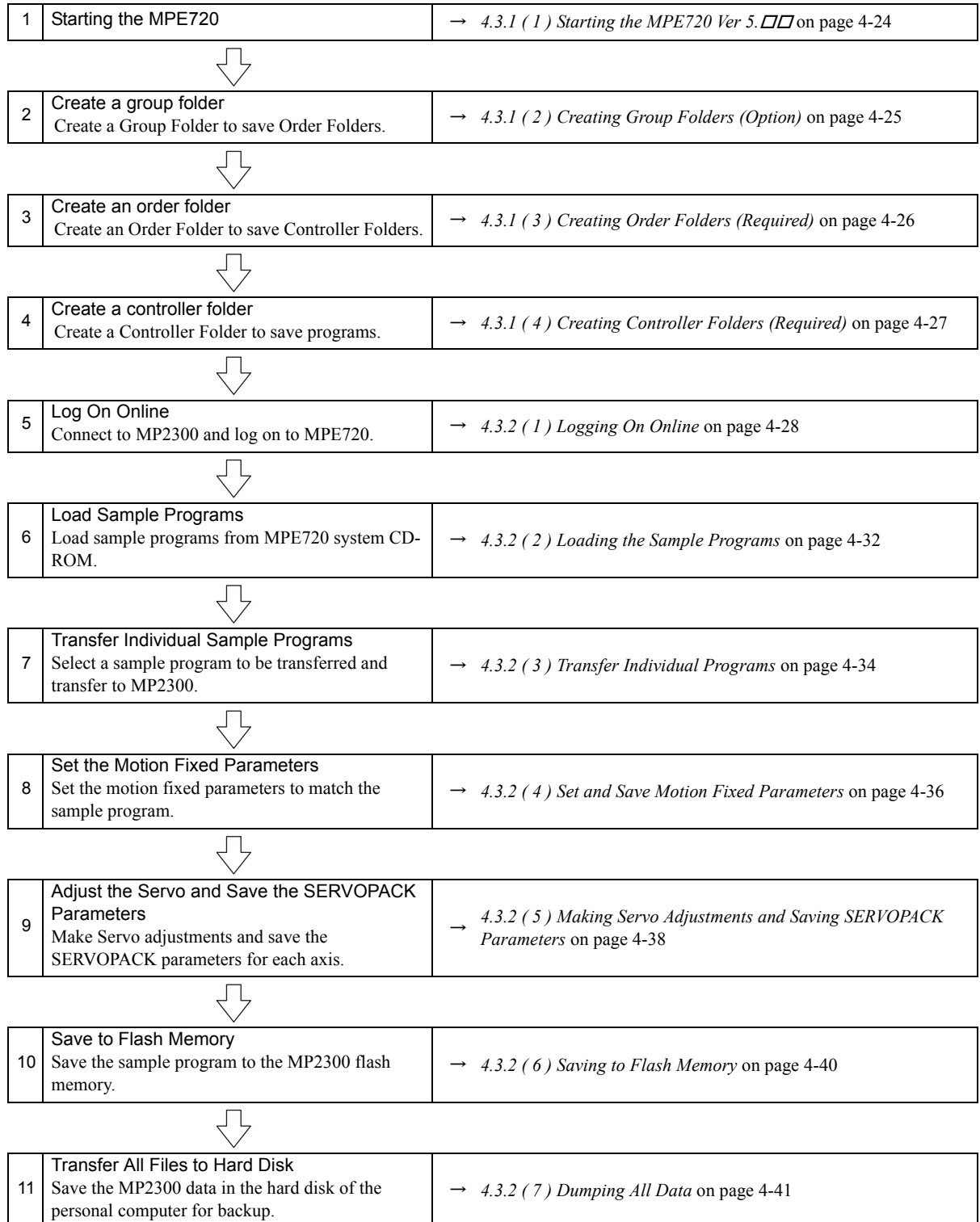

4.3.1 Starting MPE720 Ver 5.□□ and Creating Folders

This section describes the preparation for connecting the MPE720 (motion programming software, optional) to the MP2300 and the method for installing the sample program for the MP2300.

The explanation is given assuming that the MPE720 has been installed on your personal computer.

- Refer to *Machine Controller MP900/MP2000 Series MPE720 Software for Programming Device User's Manual* (Manual No.: SIEPC88070005) for the installation method of MPE720.

(1) Starting the MPE720 Ver 5.□□

Start the MPE720 Ver 5.□□ using the following procedure.

1. Open the YE_Applications Folder and double-click the **MPE720** Icon.
Or, select **Start - All Programs - YE_Application - MPE720**.

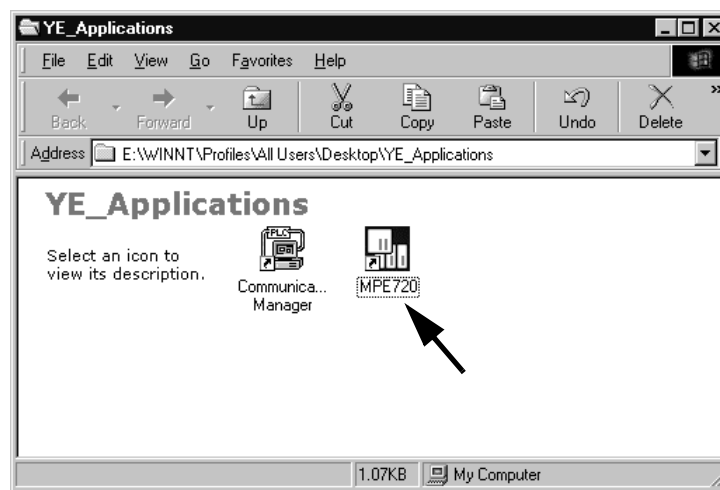

The MPE720 starts up and the **File Manager** Window appears.

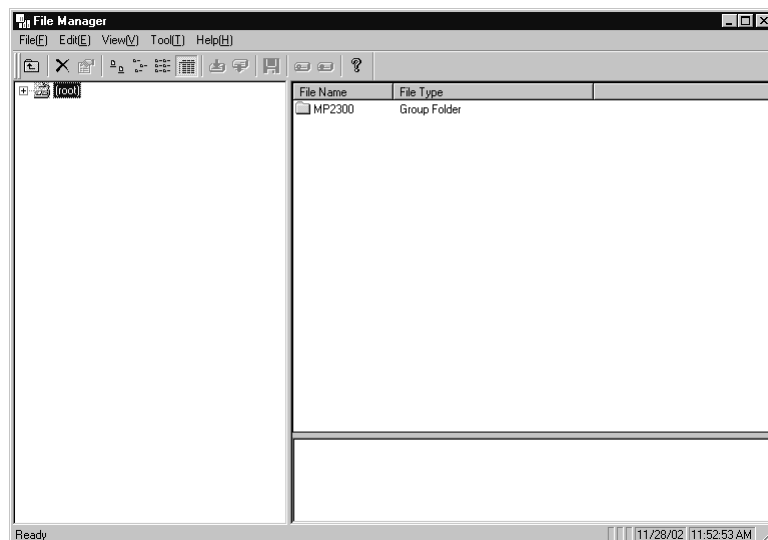

(2) Creating Group Folders (Option)

In the **File Manager** Window, create a group folder for storing order folders.

- Refer to **Group Folders, Order Folders, Controller folders** at the bottom of this page for more information about these folders.

1. Right-click (**root**) and select **New - Group Folder** from the pop-up menu.

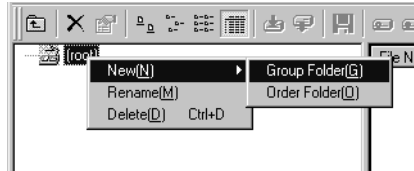

The **Make New Folder** Dialog Box will appear.

2. Enter a group folder name of up to 8 characters and click the **OK** Button.

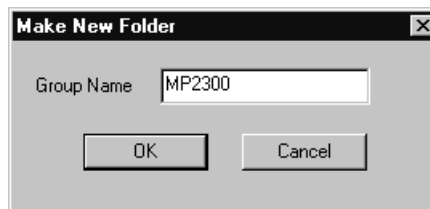

A new group folder will be created. Double-click (**root**) or click  to display the entered group folder name.

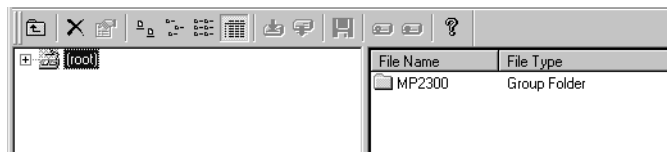

■ Group, Order, and PLC folders

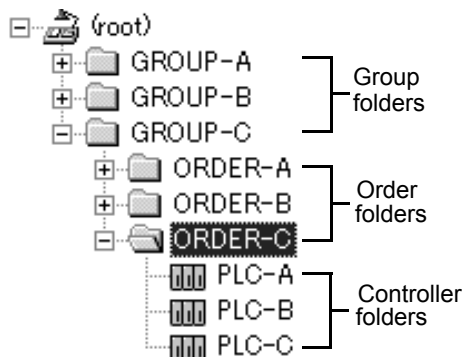

Group folders, order folders, and PLC folders form part of a directory tree, as shown in the figure to the left. Programs created using MPE720 are saved to PLC folders.

MPE720 cannot create programs if no PLC folder exists. PLC folders cannot be created if no order folder exists. For this reason, always create an order folder and PLC folder. Creating group folders is optional.

(3) Creating Order Folders (Required)

In the **File Manager** Window, create an Order Folder for storing Controller Folders.

1. Right-click (**root**) or the Group Folder in which the Order Folder is to be created and select **New - Order Folder** from the pop-up menu.

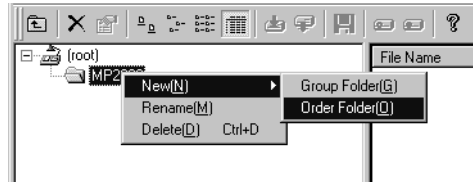

The **Make New Folder** Dialog Box will appear.

2. Enter an Order Folder name of up to 8 characters and click the **OK** Button.

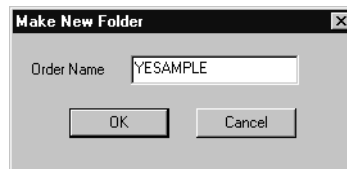

A new Order Folder will be created. Click the group folder or **[+]** to display the entered Order Folder name.



(4) Creating Controller Folders (Required)

In the **File Manager** Window, create a Controller Folder for storing programs.

1. Right-click the Order Folder in which the Controller Folder is to be created and select **Create New Folder - Controller Folder** from the pop-up menu.

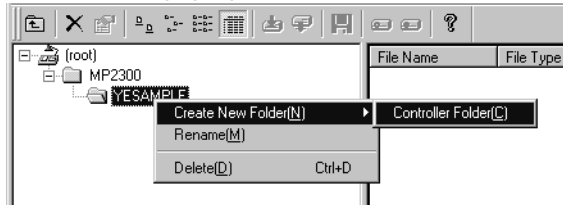

The **Controller Configuration** Dialog Box will appear.

2. Enter a Controller Folder name of up to 8 characters under **Controller Name**, select **MP2300** under **Controller Type**, and click the **OK** Button.

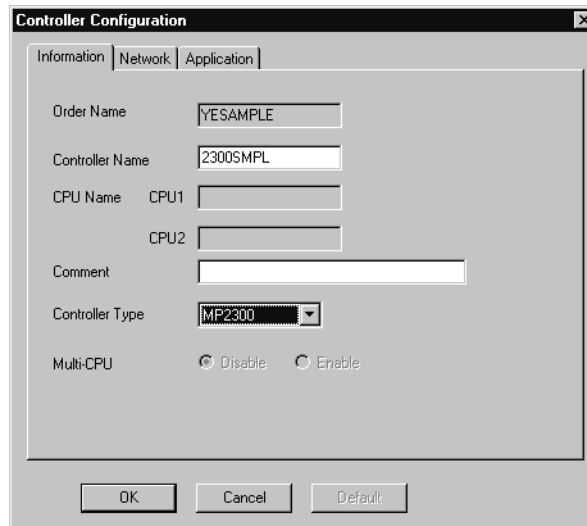

A new Controller Folder will be created. Click the Order Folder or  to display the entered Controller Folder name.

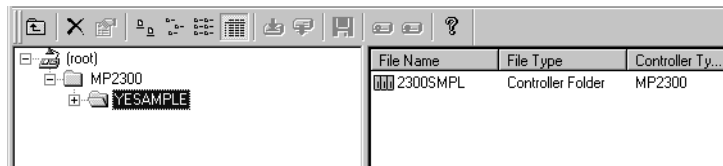

4.3.2 Reading Sample Programs and Setting and Saving Parameters

This section use sample programs to explain how to log on after being connected to the MP2300, transfer programs, set motion fixed parameters, and log off. The following flowchart outlines the order of the explanations.

(1) Logging On Online

Use the following procedure to connect to the MP2300 and log on online to the MPE720 to transfer programs.

■ Connecting to the MP2300

1. Right-click on the Controller Folder that has been created and select **Online** from the pop-up menu that is displayed.

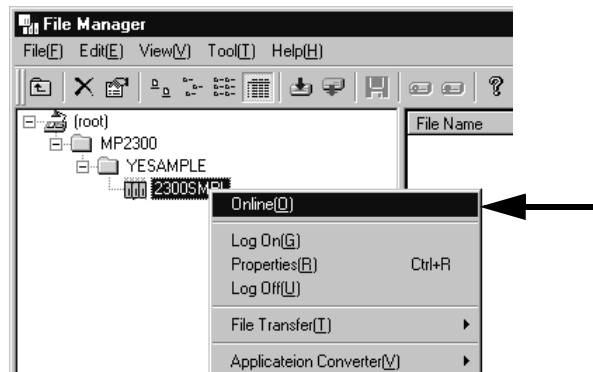

A confirmation dialog box will appear. Click the **Yes** Button to switch to online mode.

- The communication mode cannot be changed while logging on to the Controller folder is performed when using MPE720. If a *Cannot change to CPU while logged on* message is displayed when **Online** is selected, refer to 4.3.3 (2) *Logging Off* on page 4-43 and log off from the Controller folder.

2. Right-click on the Controller Folder that was selected in step 1 and select **Properties** from the pop-up menu that is displayed. Check that a check mark appears to the left of **Online** and **Online** is displayed in the data area at the bottom right of the window.

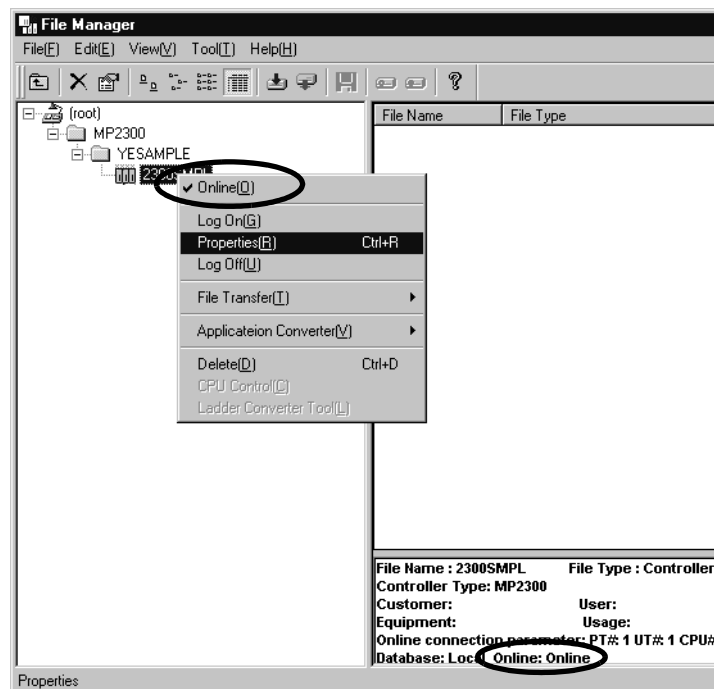

The **Controller Configuration** Dialog Box will appear.

3. Select the **Network** Tab Page and check that **OnLine** is set to **Yes**. Under **Logical Port No. (Device Type)**, select the logical port number to be used, from the logical ports set using the communication process. The contents displayed on the tab page changes according to the selected port number.

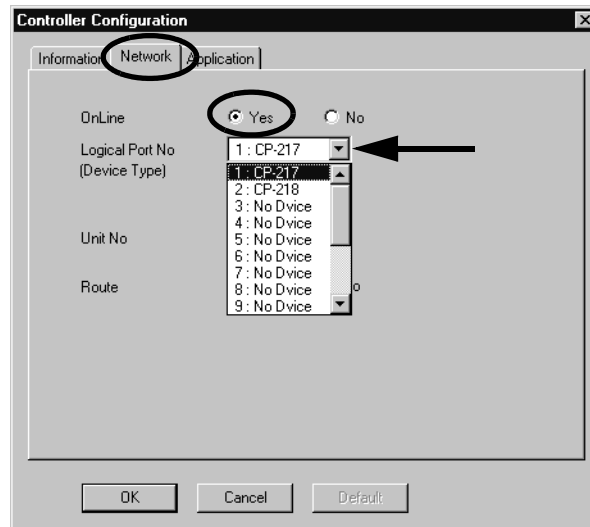

- ♦ CP217 represents the RS-232C connection (serial port), and CP218 represents the Ethernet connection.

4. < For RS-232C Connection >

Leave the values other than the **Logical Port No** on their default settings, and click **OK** Button.

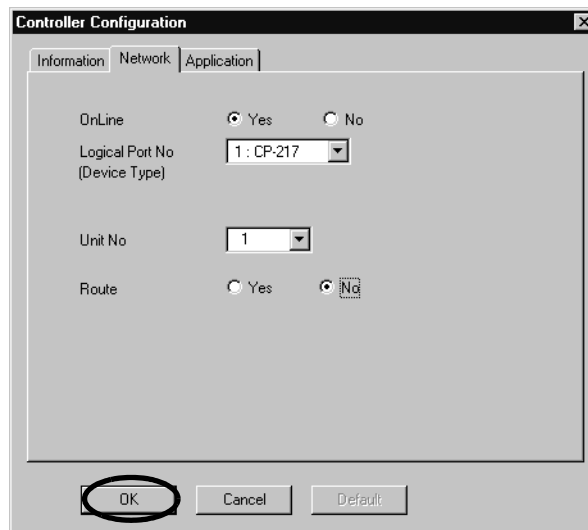

<For Ethernet Connection >

Enter the IP address of the Communication Module at the MP2000 Series Machine Controller and click **OK** Button.

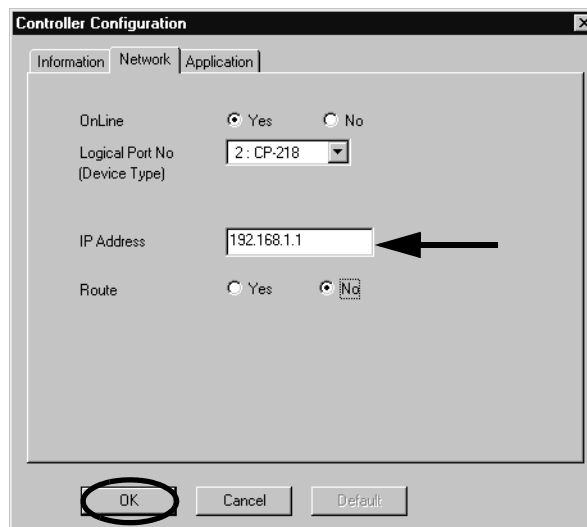
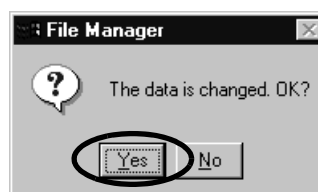
**5.** Click the **Yes** Button in the dialog box that is displayed next to complete selection of the logical port.

■ Logging On Online

- When using MPE720 Ver 5.00, logging on is performed for each Controller Folder. Controller Folders that have not been logged onto cannot use the MPE720 functions.

- Right-click on the Controller Folder that was selected in step 1 and select **Log On** from the pop-up menu that is displayed.

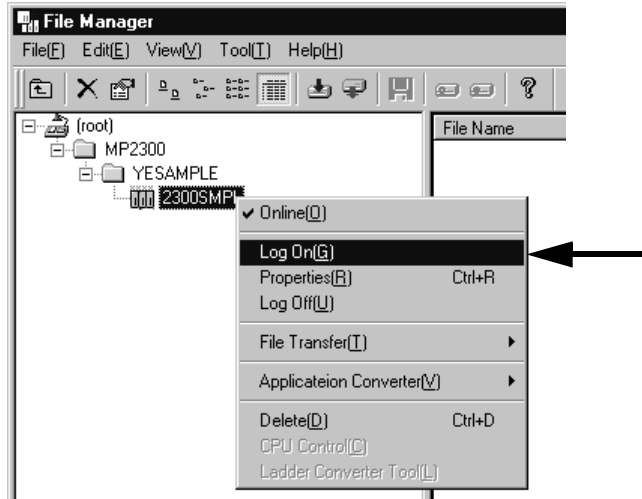

The **CPU Log On** Dialog Box will appear.

- Enter **USER-A** (default) under **User Name** and **Password**, and click the **OK** Button.

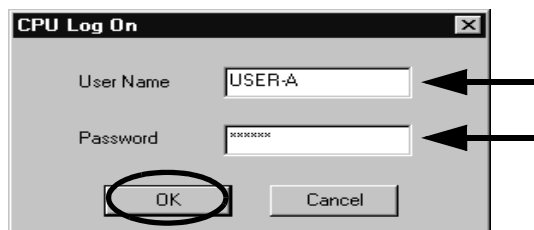

Logon will be executed for the selected Controller folder, and the dialog box will close.

- The user name and password may have already been changed. Ask the system administrator beforehand.
- The user name and password are changed from the **File** menu in the **File Manager** Window. Refer to *Machine Controller MP900/MP2000 Series MPE720 Software for Programming Device User's Manual* (Manual No.: SIEPC88070005) for details.

(2) Loading the Sample Programs

The sample programs on the MPE720 system CD-ROM will be decompressed on the personal computer and loaded to the Controller Folder. Set the MPE720 system CD-ROM in the CD-ROM drive of the personal computer.

1. Use Explorer to open the **SAMPLE - Eng** folders and double-click the **2300SMPL_E.EXE** icon.

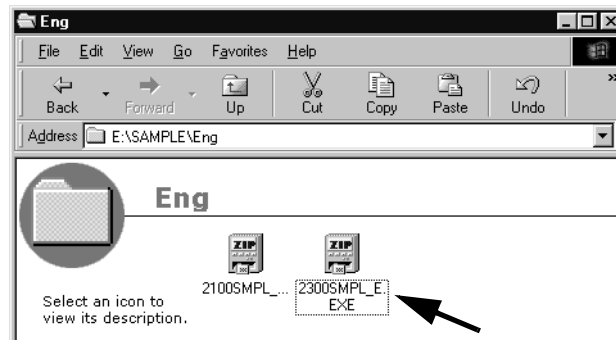

A dialog box for specifying where to unpack the file will appear.

2. Specify the destination path (a path other than File Manager) and click the **Decompress** Button.

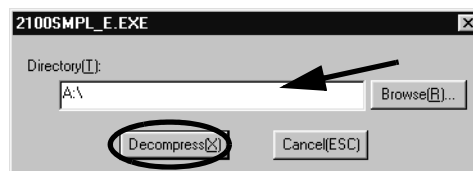

The sample program will be unpacked and saved to the specified path and a folder called 2300SMPL_E will be created.

3. Right-click on the Controller folder where the sample program is to be saved in **File Manager** Window and select **Transfer - All Files - From Another Drive to MPE720** in the pop-up menu that is displayed.

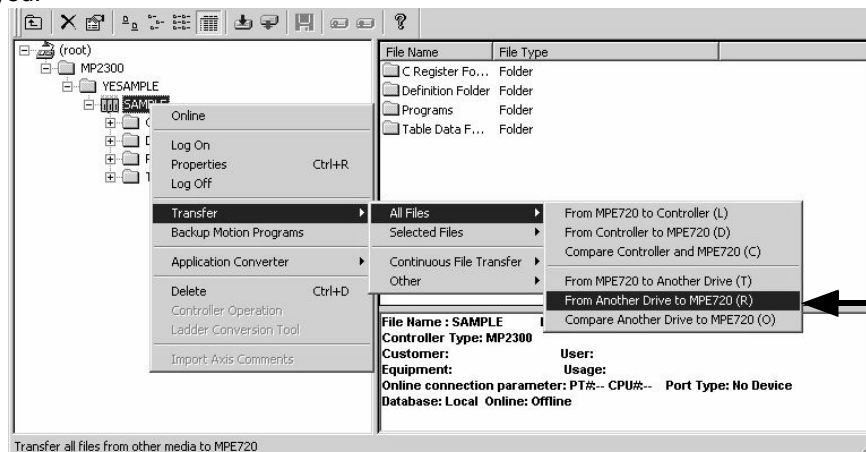

An execution confirmation dialog box will appear.

4. Deselect *Compression transmission*. Check the *Source*. If the *Source* is different from the decompression destination folder, click the **Change** Button and continue to step 5. If the *Source* is correct, move to step 6.

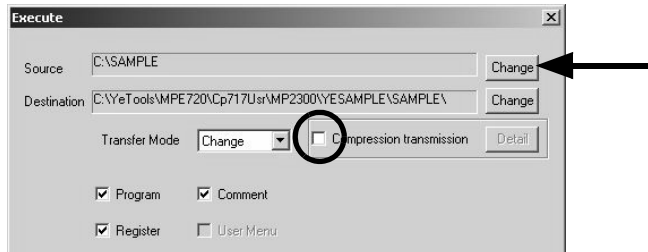

5. The Change Transfer Drive Dialog Box will appear. Click the **Detail** Button to open the Select the Folder Dialog Box.



6. Three sub-folders under the 2300SMPL_E folder will appear. Click the **Select** Button to close the dialog box.

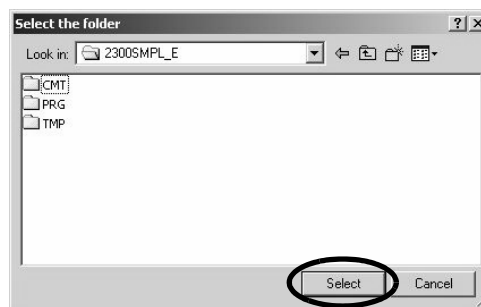

7. The **Execute** Dialog Box will appear. Click the **OK** Button.

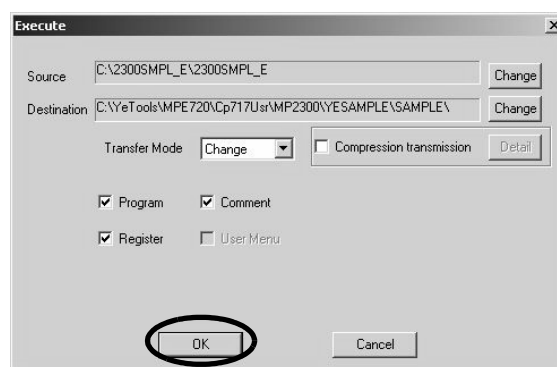

The **Execution Status** Dialog Box will appear. Once the transfer has been completed, a confirmation dialog box will appear. Click the **OK** Button.

8. The All Media to MPE720 Window will appear. Select **File - Exit** to end reading files to the MPE720.

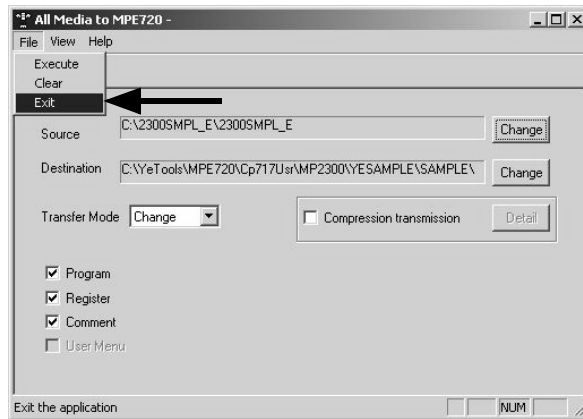

(3) Transfer Individual Programs

Transfer the programs that have been read to the MPE720 individually to the MP2300.

1. Right-click on the Controller Folder that has been logged onto online and select **Transfer - Selected Files - From MPE720 to Controller** from the pop-up menu that is displayed.

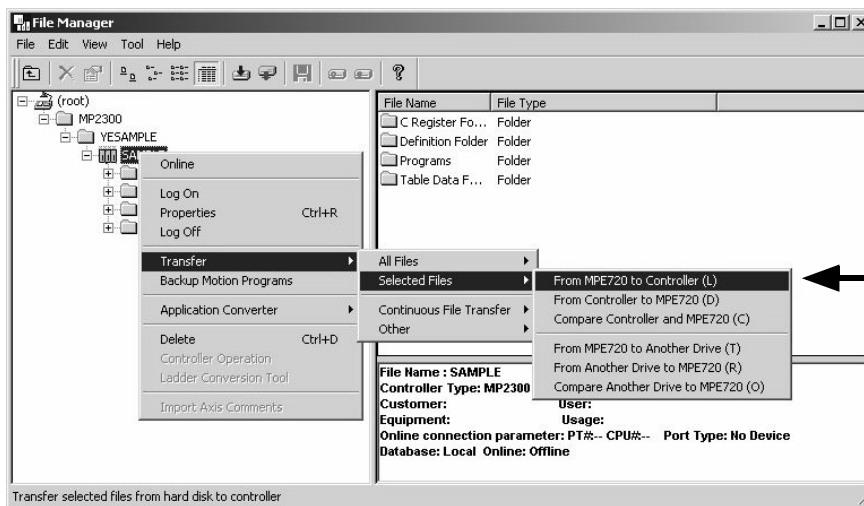

The Individual Load Window will appear.

2. Select the programs to be transferred. For programs with a **Details** Button next to them, click the **Details** Button and select the individual function programs for the program listed in the Set Details Dialog Box that is displayed.
 In this example, *DWG*, *Scan Time*, *Data Trace*, *Group Definition*, and *Motion Main Program* are selected, and detailed settings are made for *DWG* and *Motion Main Program*.

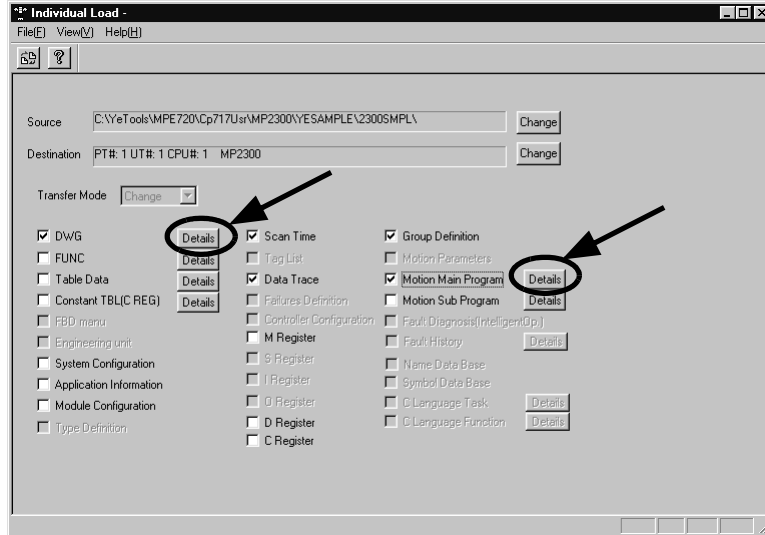

a) **Set Drawing Details Dialog Box**

The details for the DWG sample program are shown below. Select the programs to be transferred and click the **OK** Button. If *Select All* is selected, all programs for the DWG program will be selected. In this example, select *Select All* and click the **OK** Button to return to the Individual Load Window.

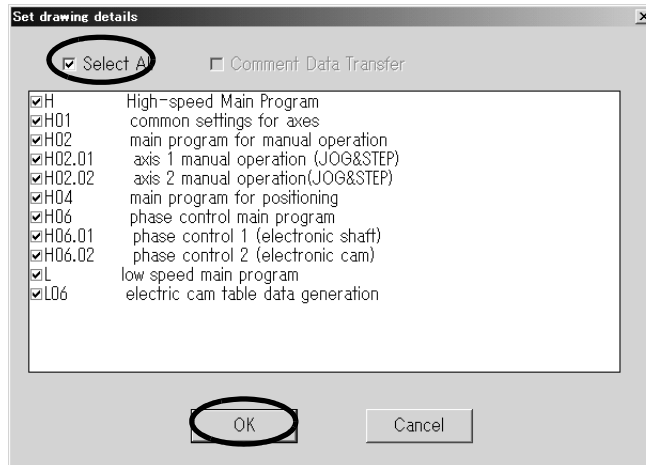

b) **Motion Main Program Detail Set Dialog Box**

The details for the Motion Main Program of sample program are shown below. In this example, select *Select All* and click the **OK** Button to return to the **Individual Load** Window.



3. Select **File - Execute**.

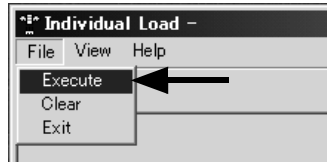

Click the **Yes** Button in the confirmation dialog box to start the file transfer. When the transfer has been completed, a confirmation dialog box will appear again. Click the **OK** Button.

4. Select **File - Exit** in the **Individual Load** Window to exit the transfer.

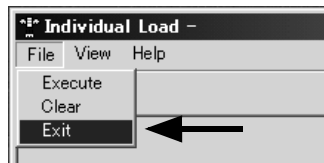

(4) Set and Save Motion Fixed Parameters

This section describes the procedure for setting motion fixed parameters for axes 1 and 2 to match the sample program .

- When using a program, set the fixed parameters to match the devices being used. Refer to *Machine Controller MP2000 Series Built-in SVB/SVB-01 Motion Module User's Manual* (Manual No.: SIEPC88070033).

1. Double-click the **2300SMPL** Controller Folder - **Definition Folder** in the **File Manager** Window to display the five folders contained within it. Double-click the **Module Configuration** Folder.

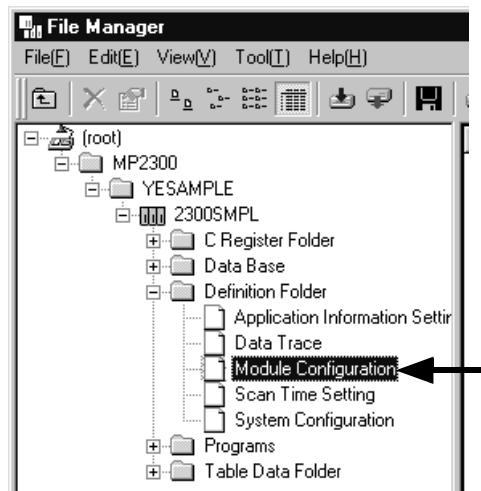

The **Enginnering Manager** Window will open and the **Module Configuration** Window will appear.

2. Select **00** in the **Controller Area** and double-click the **3** in the **Module Details MP2300 SLOT#00** Area in the **Module Configuration Window**.

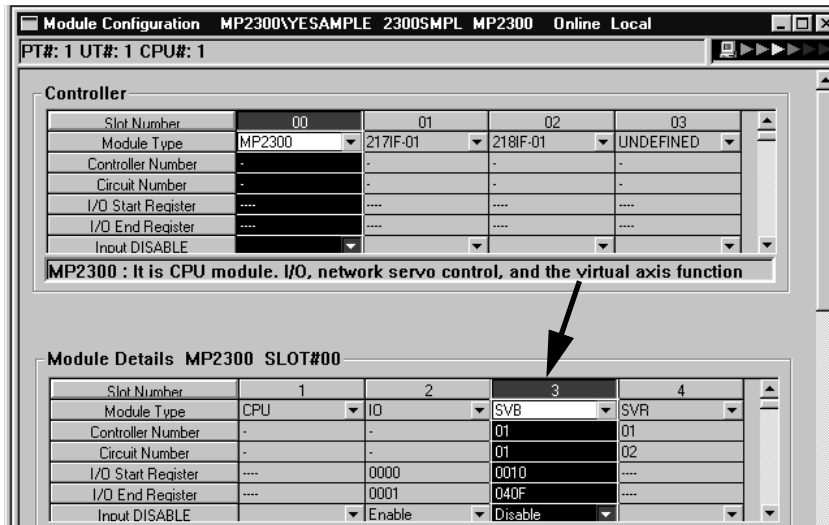

The **SVB Definition Window with Fixed Parameters Tab Page** will appear.

3. Set the fixed parameters for axis 1.

Select **Axis 1** from the axis selection box at the top-left of the window and select **mm** under **No. 4 Reference unit selection** on the **Fixed Parameters Tab Page**.

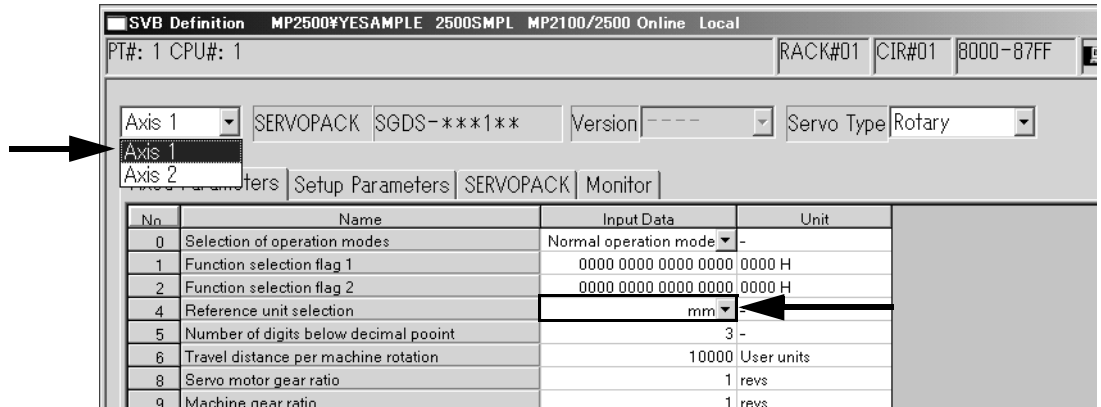

4. In the **Engineering Manager Window**, select **File - Save** to save the settings for axis 1 fixed parameters.

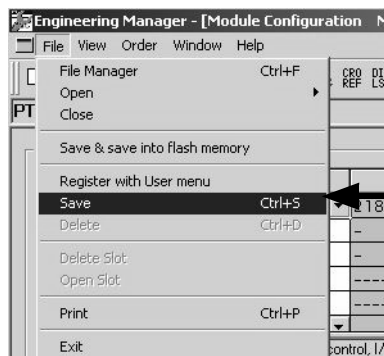

5. Follow steps 3 and 4 to set and save the fixed parameters for axis 2 as well.

The process for saving fixed parameter settings has now been completed. Next, save the SERVOPACK parameters.

(5) Making Servo Adjustments and Saving SERVOPACK Parameters

This section describes how to make Servo adjustments and save the SERVOPACK parameters for each axis to the MP2300.

1. Execute servo gain and other adjustments for each Servo.
 - Refer to each SERVOPACK manual for information on the Servo adjustments.
2. Select the axis in the **SVB Definition** Window, then click the **SERVOPACK** Tab to display the **SERVOPACK** Tab Page.

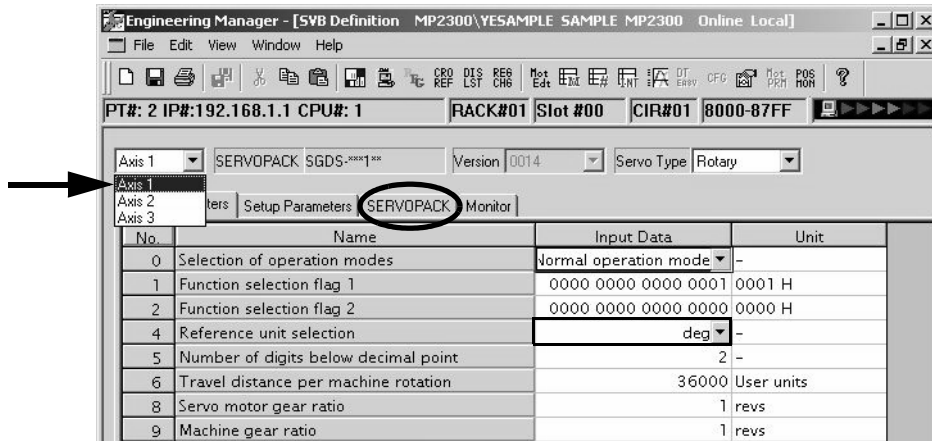

3. Select **Edit - Copy Current Value**.

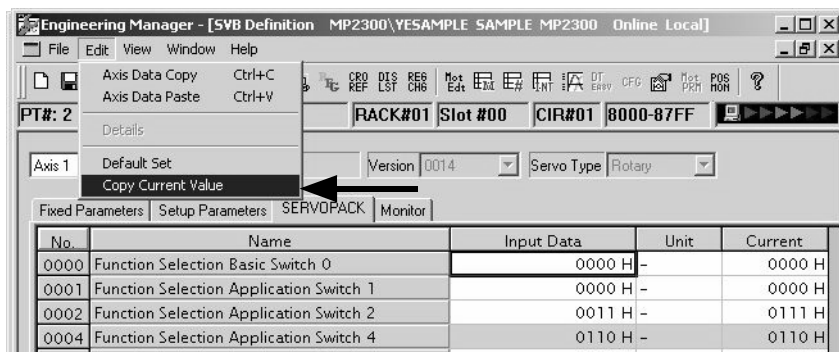

A confirmation dialog box will appear.

- The data in the **Input Data** Column is the SERVOPACK data saved to the MP2300 and the data in the **Current Value** Column is the data set to the SERVOPACK.
 - Refer to *B Current Values and Set Values (Input Data) in the SVB Definition Window* on page A-5 for information on the relationship between *Current Value* and *Setting Data*.
4. Click the **Yes** Button in the confirmation dialog box to write the SERVOPACK data (current position) as the MP2300 settings data.

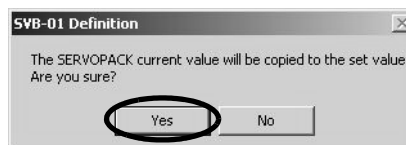

5. Select **File - Save** to save the SERVOPACK settings for axis 1 to the MP2300.

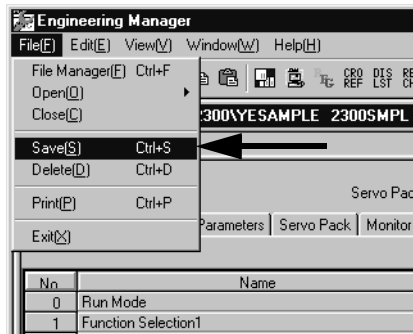

6. Follow steps 2 to 5 to write and save the SERVOPACK current position for axis 2 as settings data as well.
7. Select **File - Exit** to exit the setting and saving process in the **Engineering Manger** Window.

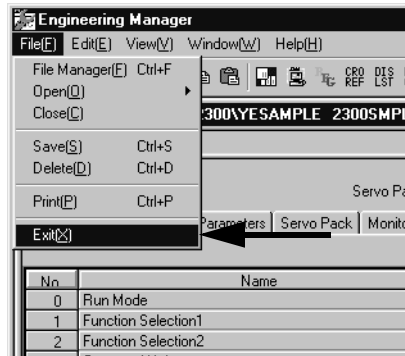

(6) Saving to Flash Memory

Save sample programs that have been transferred individually to the MP2300 to the MP2300 flash memory using the procedure below.

1. Right-click the Controller Folder in which the sample programs have been saved and select **Transfer - Other - Save to Flash** from the pop-up menu that is displayed.

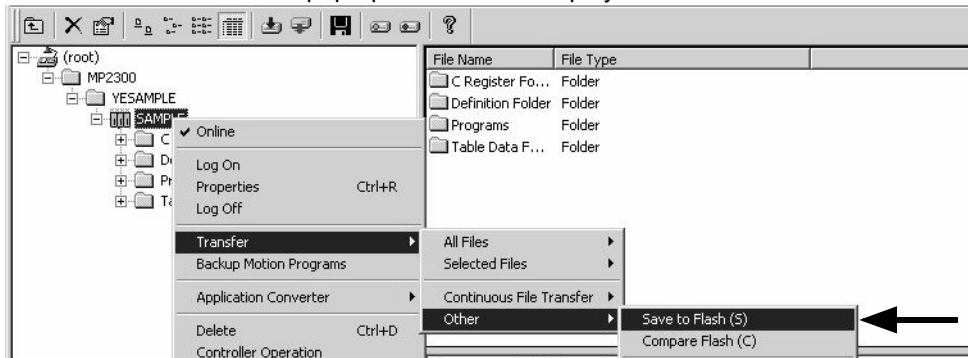

The Save Flash Memory Content Window will appear.

2. Select **File - Execute**.

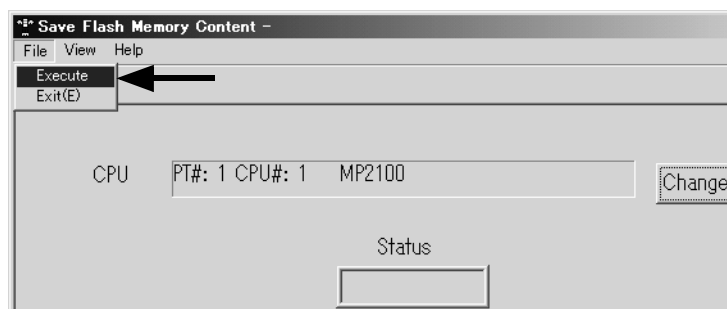

3. Click the **Yes** Button in the displayed confirmation dialog box, and then click the **Yes** Button in the **TrnSys** Dialog Box that is displayed.



4. Another confirmation dialog box will be displayed. Click the **Yes** Button. The data will be saved to flash memory. When saving to flash memory has been completed, a dialog box to confirm that the CPU is to be run will be displayed. Click the **Yes** Button. Then the display will automatically return to the **Save Flash Memory Content** Window.

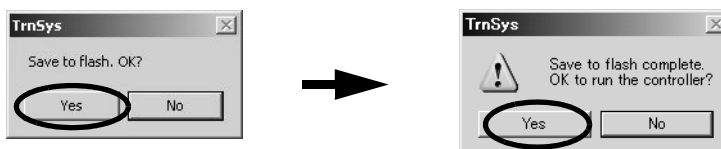

5. Select **File - Exit** to exit saving to flash memory.



(7) Dumping All Data

Execute All Program File Dump to back up to a personal computer the module configuration definitions automatically detected by the MP2300 during self-configuration and edited programs. The MP2300 program data and the program data in the personal computer hard disk are synchronized when all programs are dumped.

1. Right-click the Controller Folder in which the sample programs have been saved, and select **Transfer - All Files - From Controller to MPE720** from the pop-up menu that is displayed.

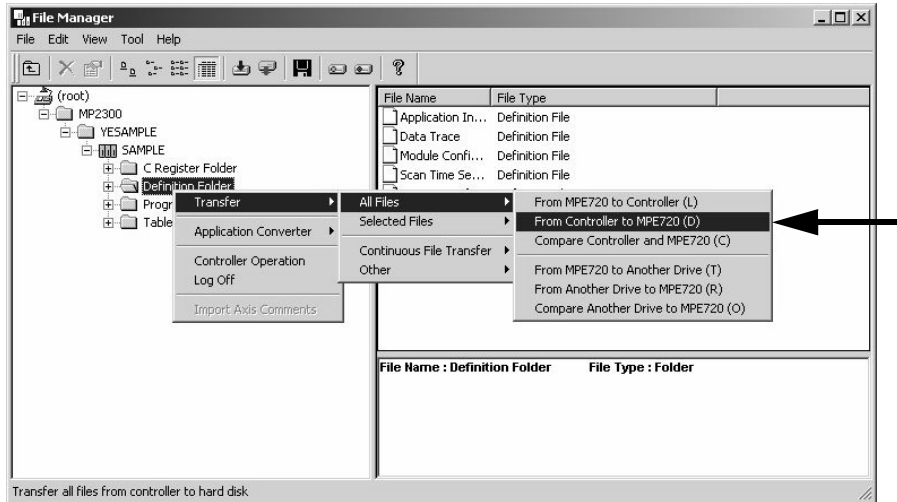

An execution confirmation dialog box will appear.

2. Check the details and click the **OK** Button.

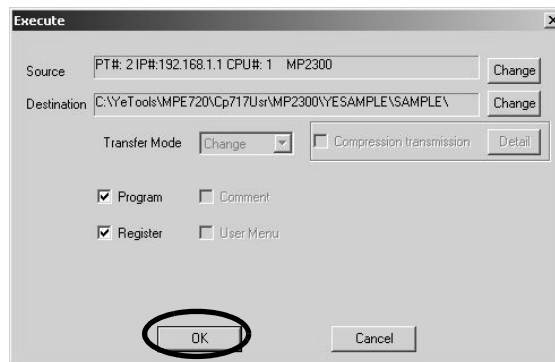

The file transfer will start. A notification dialog box will be displayed when the transfer has been completed. Click the **OK** Button in the dialog box to display the **All Dump** Window.

3. Select **File - Exit** to stop the dumping of all data.

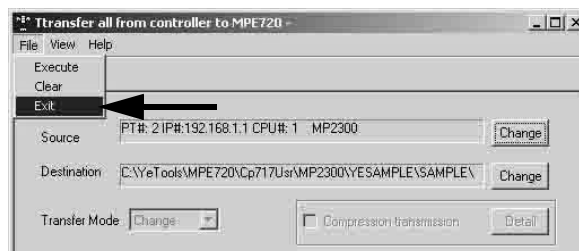

Now, the sample program is available. Refer to 4.4 *Checking Sample Program Operation* on page 4-44 to check the sample program operation.

4.3.3 Other Operations

This section describes the CPU RUN setting and log-off operation required when MPE720 Ver 5.□□ is used.

(1) CPU RUN Settings

If the CPU STOP status is not cleared after executing processes such as saving to flash memory, use the following procedure to return to RUN status.

1. Right-click on the Controller Folder where sample programs are saved and select **Controller Operation** from the pop-up menu that is displayed.

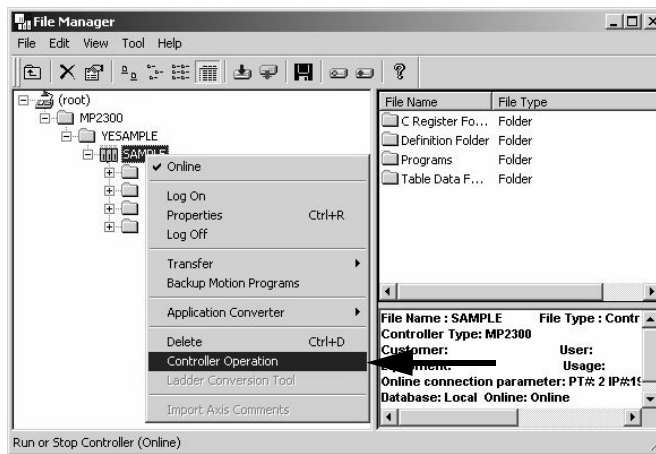

The Controller Running Status Dialog Box will appear.

2. Click the **Run** Button.

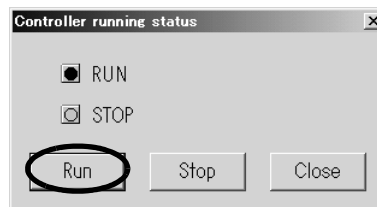

- To stop the CPU, for example to verify errors, click the **STOP** Button displayed here.

3. Change confirmation dialog box will be displayed. Click the **Yes** Button to return to the **Controller Running Status** Dialog Box. Check that the RUN LED indicator is lit.

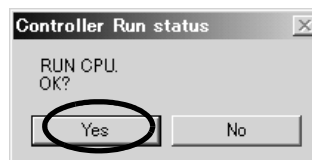

4. Click the **CLOSE** Button in the **Controller Running Status** Dialog Box to exit RUN settings.

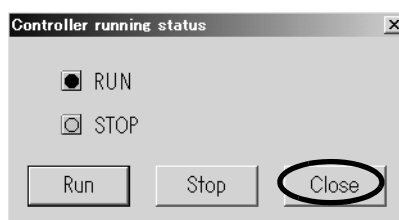

(2) Logging Off

Log off once the work using MPE720 (Embedded) has been completed.

1. Right-click on the Controller Folder where sample programs are saved and select **Log Off** from the pop-up menu that is displayed.

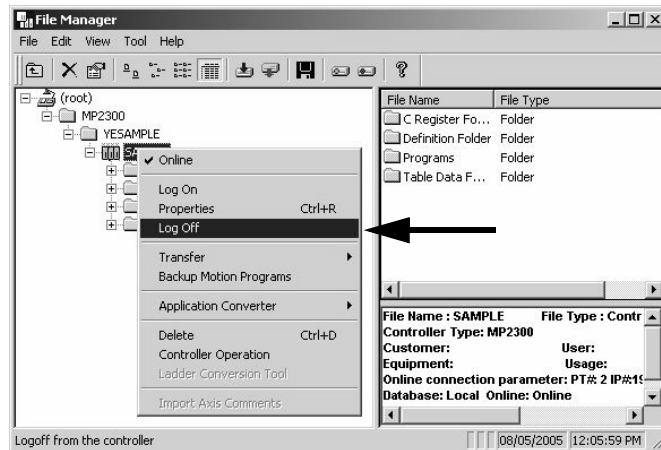

2. Click the **Yes** Button in the displayed dialog box to complete the logoff process.

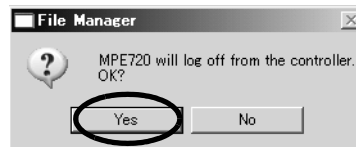

4.4 Checking Sample Program Operation

This section describes how to check four operations in the model system applying sample programs started in 4.3 or 4.4 by using the Tuning Panel Window for sample programs.

4.4.1 How to Open the Tuning Panel Window

(1) From Engineering Manager Window

Use the following procedure to open the **Tuning Panel** Window from the **Engineering Manager** Window.

1. Open the **Engineering Manager** Window, and then select **File - Open - Program - Turning Panel** from the menu bar.
 - For information on how to open the **Engineering Manager** Window of MPE720 Ver 6.□□, refer to 4.2.2 (1) *Setting and Saving Motion Fixed Parameters* on page 4-17.
 - For information on how to open the **Engineering Manager** Window of MPE720 Ver 5.□□, refer to 4.3.2 (4) *Set and Save Motion Fixed Parameters* on page 4-36.

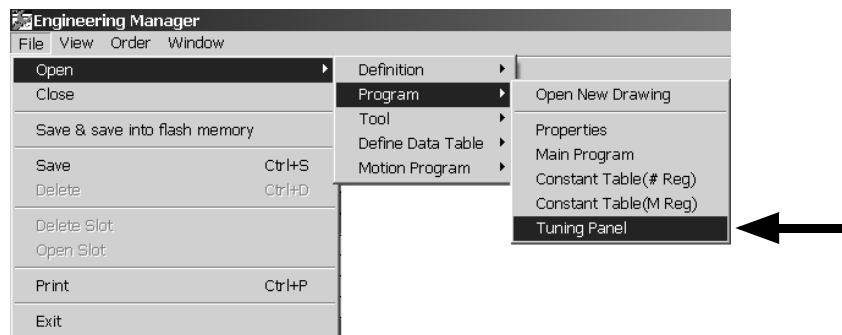

The **Open DWG setting** Dialog Box will appear.

2. Enter the number of the drawing (program) to be displayed in the **Tuning Panel** Window in the **Name** input field, and then click the **OK** Button.



When using MPE720 Ver 6.□□, the message box shown in step 3 will appear and ask for confirmation to open the **Tuning Panel** Window. (To step 3)

When using MPE720 Ver 5.□□, the **Tuning Panel** Window will open.

3. Click the **Yes** Button to open the **Tuning Panel** Window.

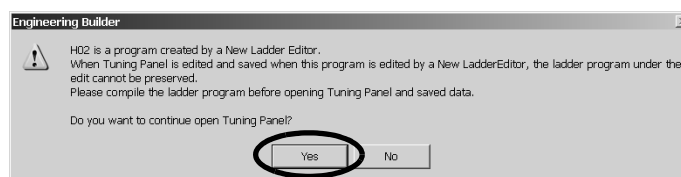

(2) From the File Manager Window (For MPE720 Ver 5.□□ Only)

When using MPE720 Ver 5.□□, the **Tuning Panel** Window can also be opened from the **File Manager** Window by using the following procedure.

1. Log on online, open the **Programs** folder, and then open the **High Scan Programs** folder in the PLC folder where the sample programs are saved in the **File Manager** Window.
2. Right-click the **H02** Drawing in the **High Scan Programs** folder and select **Open - Tuning Panel** from the pop-up menu that is displayed.

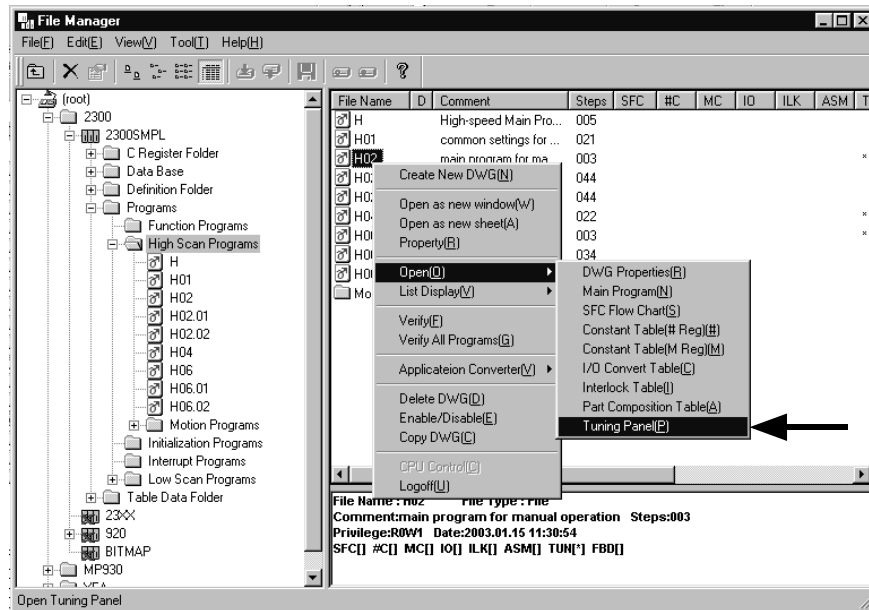

Engineering Manager will start and the following **Tuning Panel** Window will be displayed.

4.4.2 Operation Check 1: Manual Operation

(1) Program Outline

This section describes how to execute JOG and STEP operations for Servomotor 1 or 2 (axis 1 or 2) using a ladder program such as the one shown below.

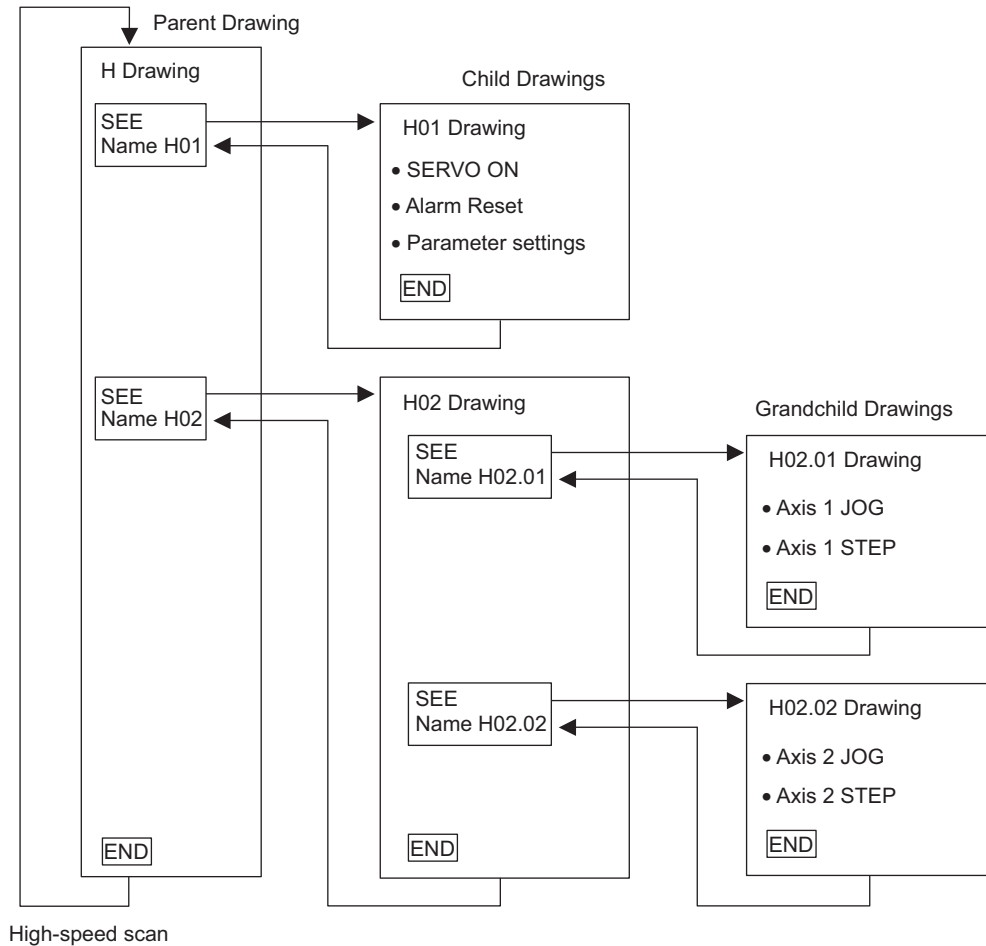

- Refer to 4.4.2 (4) *Sample Program Details* on page 4-49 for details of each program (drawing).
- A simple device is used in this example to describe the MP2300 system startup.
- This device has no power OFF circuit for the SERVOPACK in the event of emergency stops or overtravel. Include a proper emergency stop circuit in actual devices.

(2) H02 Drawing Tuning Panel

Display the H02 Drawing Tuning Panel as shown in 4.4.1 *How to Open the Tuning Panel Window* on page 4-44. Model system operation can be controlled by writing the current values for **common operation** and **Manual Operation and Setting** from the Tuning Panel.

Nn	Data Name	S	Format	CurrentValue	Unit	Lower Limit	Upper Limit	REG-No.	Dw/G
1	***** common monitor *****		XXXX	00000		00000	32767	Dw00010	L
2	axis 1 operation ready		ON/OFF	OFF				IB80000	
3	axis 2 operation ready		ON/OFF	OFF				IB80800	
4	axis 1 current position		XXXXXXXXXX	0000000000		-0214783648	2147483647	IL8016	
5	axis 2 current position		XXXXXXXXXX	0000000000		-0214783648	2147483647	IL8096	
6	***** common operation *****		XXXX	00000		00000	32767	Dw00010	L
7	servo on PB	S	ON/OFF	ON				MB30000	
8	alarm reset PB	S	ON/OFF	OFF				MB300001	
9	***** manual operation and setting *****		XXXX	00000		00000	32767	Dw00010	L
10	axis 1 forward JOG	S	ON/OFF	OFF				DB000010	H02.01
11	axis 1 reverse JOG	S	ON/OFF	OFF				DB000011	H02.01
12	axis 2 forward JOG	S	ON/OFF	OFF				DB000010	H02.02
13	axis 2 reverse JOG	S	ON/OFF	OFF				DB000011	H02.02
14	axis 1 forward STEP	S	ON/OFF	OFF				DB000012	H02.01
15	axis 1 reverse STEP	S	ON/OFF	OFF				DB000013	H02.01
16	axis 2 forward STEP	S	ON/OFF	OFF				DB000012	H02.02
17	axis 2 reverse STEP	S	ON/OFF	OFF				DB000013	H02.02
18	axis 1 STEP moving amount	S	XXXXXXXXXX	0000000000		-0214783648	2147483647	DL00010	H02.01
19	axis 2 STEP moving amount	S	XXXXXXXXXX	0000000000		-0214783648	2147483647	DL00010	H02.02

(3) Procedure

Use the following procedure to confirm operation.

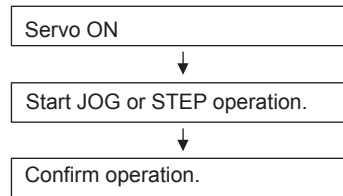

The following table gives an outline of the operation when the Tuning Panel window is used.

Data Name	Current Value Operation	Operation Outline
Servo ON PB	Current value OFF → ON	The Servomotor will turn ON and the Servo will be clamped.
	Current value ON → OFF	Servo turned OFF.
Axis 1 Forward Jog	Current value OFF → ON	Axis 1 rotates forward.
	Current value ON → OFF	Axis 1 stops.
Axis 1 Reverse Jog	Current value OFF → ON	Axis 1 rotates in reverse direction.
	Current value ON → OFF	Axis 1 stops.
Axis 2 Forward Jog	Current value OFF → ON	Axis 2 rotates forward.
	Current value ON → OFF	Axis 2 stops.
Axis 2 Reverse Jog	Current value OFF → ON	Axis 2 rotates in reverse direction.
	Current value ON → OFF	Axis 2 stops.
Axis 1 Forward Step	Current value OFF → ON	Axis 1 starts rotating forward for the moving amount set under Axis 1 STEP moving amount.
	Current value ON → OFF	STEP operation stops. Always stop after executing stepping.
Axis 1 Reverse Step	Current value OFF → ON	Axis 1 starts rotating in reverse for the moving amount set under Axis 1 STEP moving amount.
	Current value ON → OFF	STEP operation stops. Always stop after executing stepping.
Axis 2 Forward Step	Current value OFF → ON	Axis 2 starts rotating forward for the moving amount set under Axis 2 STEP moving amount.
	Current value ON → OFF	STEP operation stops. Always stop after executing stepping.
Axis 2 Reverse Step	Current value OFF → ON	Axis 2 starts rotating in reverse for the moving amount set under Axis 2 STEP moving amount.
	Current value ON → OFF	STEP operation stops. Always stop after executing stepping.
Axis 1 STEP Moving Amount	Enter any value.	Sets the STEP moving amount for axis 1.
Axis 2 STEP Moving Amount	Enter any value.	Sets the STEP moving amount for axis 2.

- It is necessary to create routines within the actual application program in order to monitor and control the registers corresponding to the signals and data listed in the table above.

(4) Sample Program Details

[a] H Drawing

The H parent drawing controls the overall sample program.

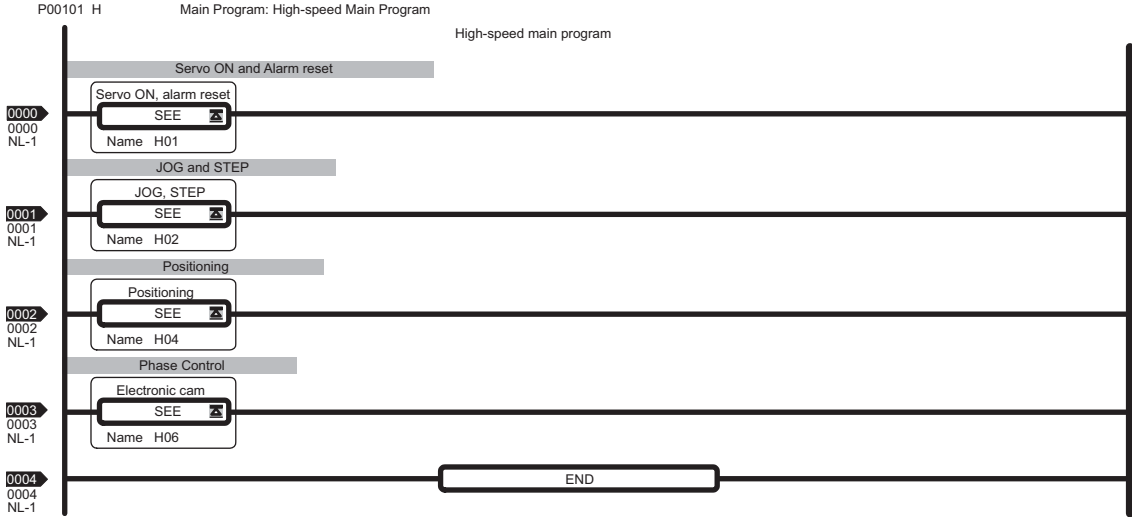

[b] H01 Drawing

The H01 child drawing turns ON the Servo, resets alarms, and sets common parameters.

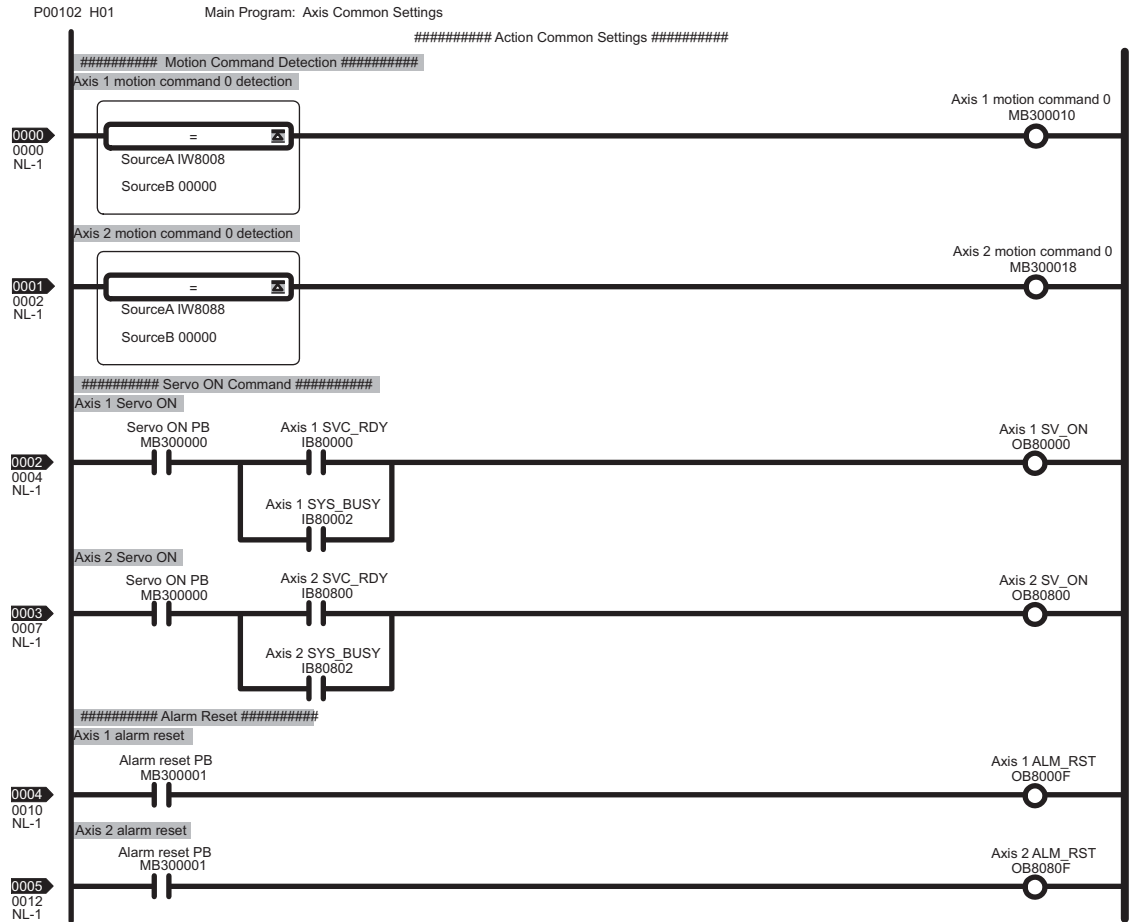

4.4.2 Operation Check 1: Manual Operation

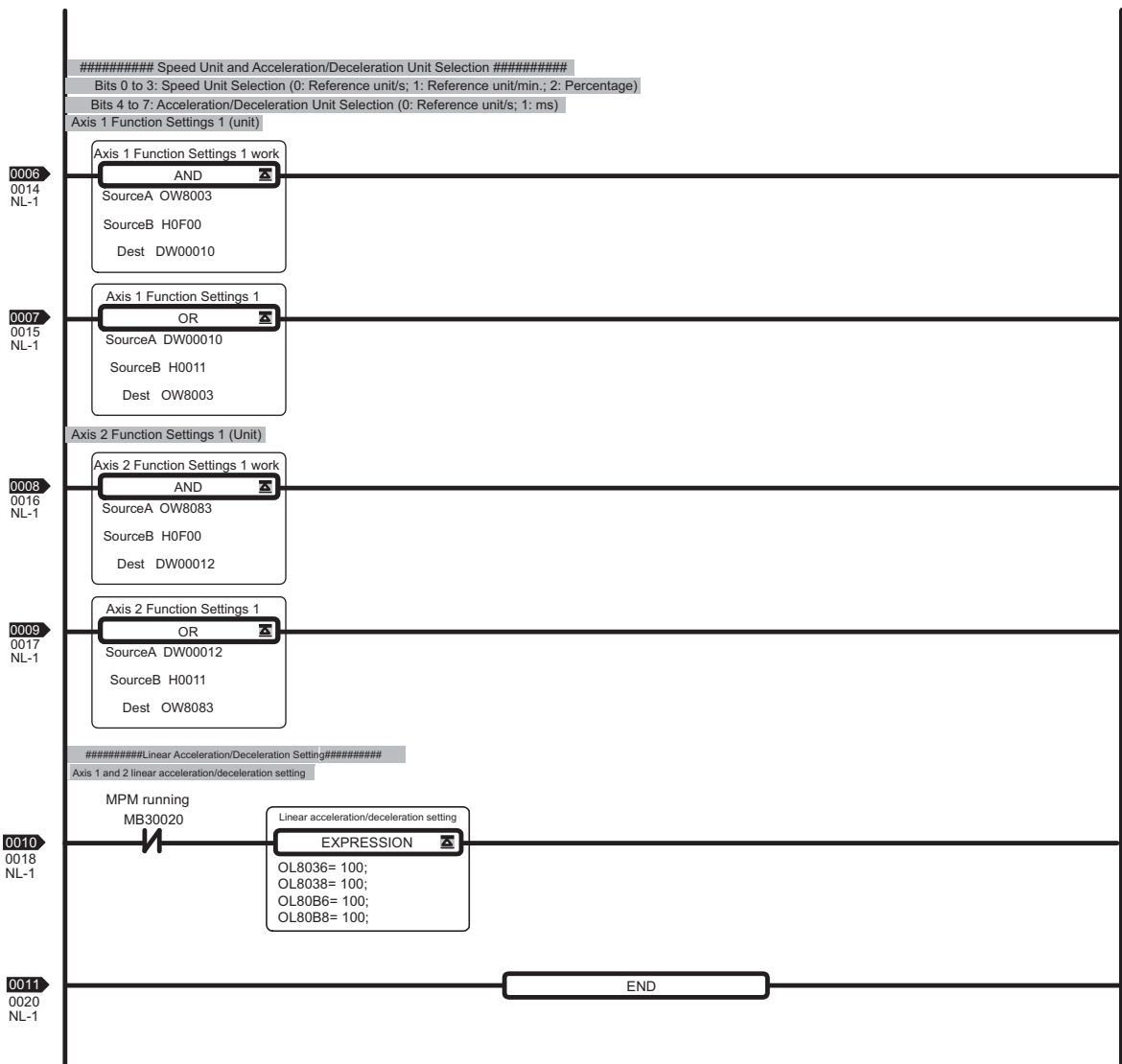

[c] H02 Drawing

The H02 child drawing controls JOG and STEP operation.

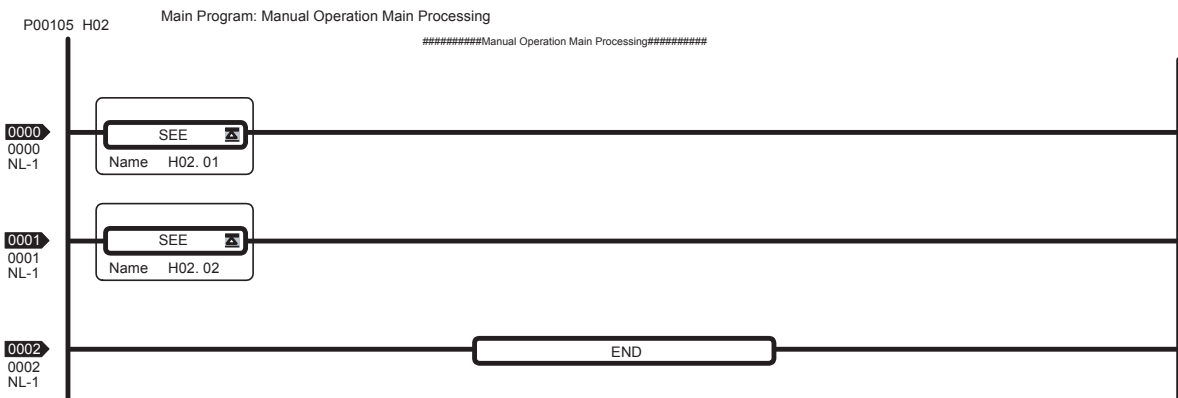

[d] H02.01 Drawing

The H02.01 grandchild drawing controls JOG and STEP operation for axis 1.

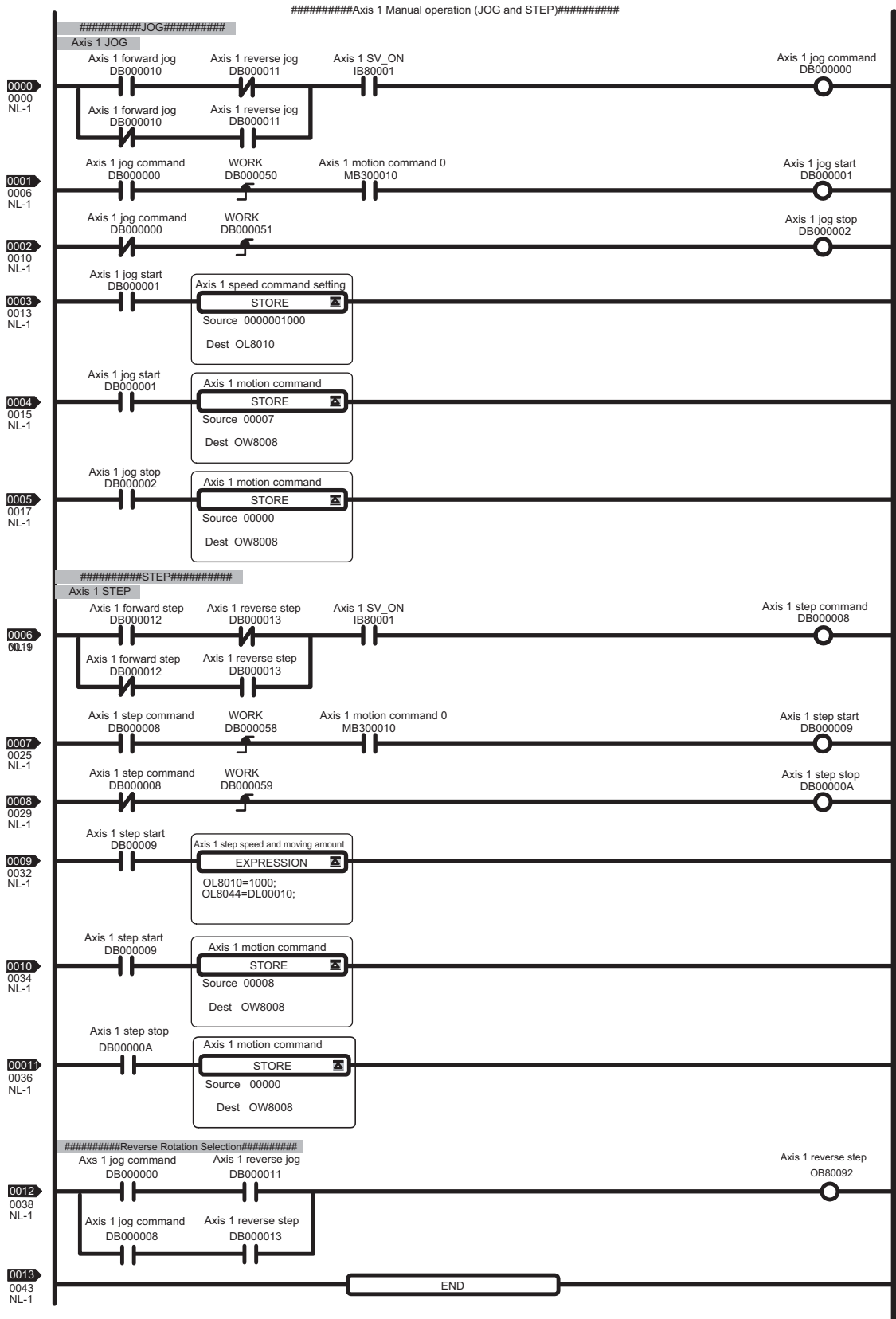

[e] H02.02 Drawing

The H02.02 grandchild drawing controls JOG and STEP operation for axis 2.

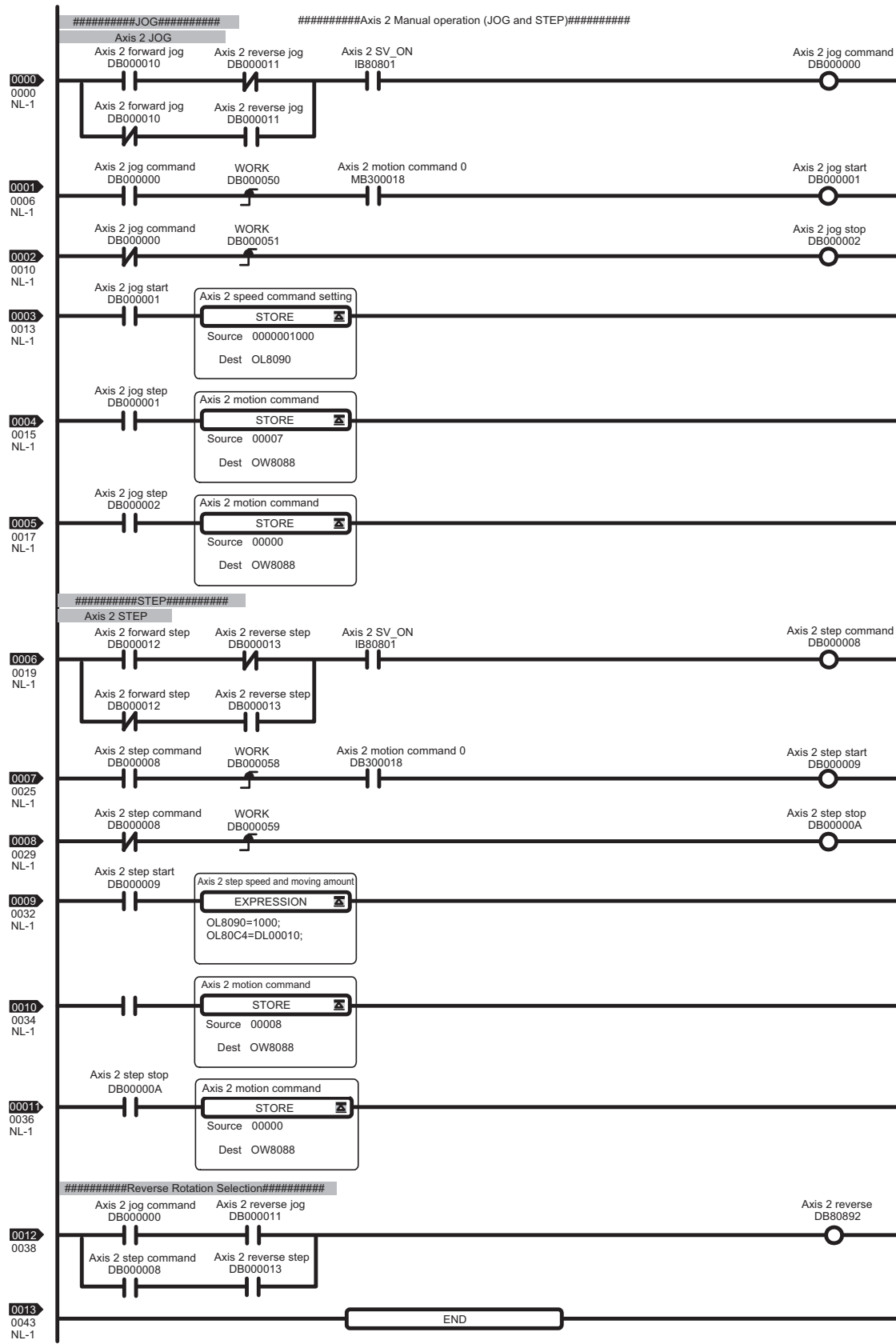

4.4.3 Operation Check 2: Position Control

(1) Operation Outline

In this example, an X-Y plotter like the one shown in the figure is operated by ladder and motion programs.

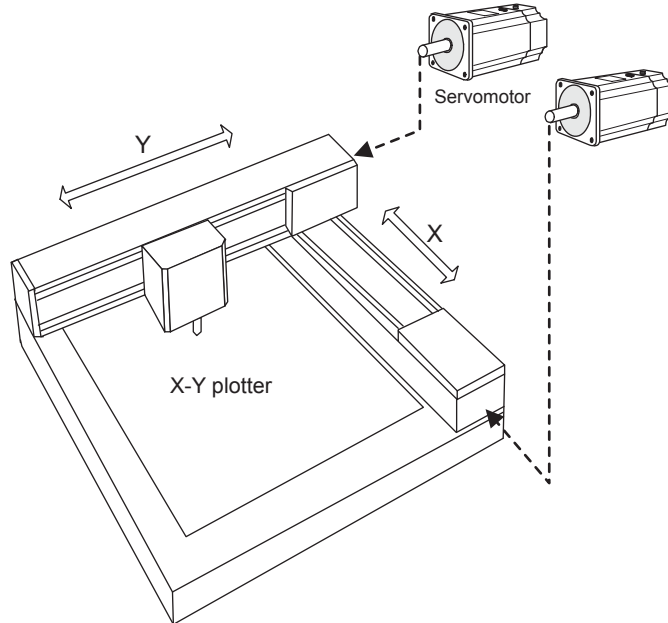

(2) Program Outline

A ladder program (H04 Drawing) and three prepared sample programs (MPM001, MPM002, and MPM003) are used to check the operation, as shown in the figure.

Programs MPM001 to MPM003 perform the following operations.

- MPM001: Zero point return using Servomotor phase-C
- MPM002: Axis 2 positioning and interpolation (with interval timer)
- MPM003: Axis 2 positioning and interpolation (without interval timer)

Motion programs are written in text format, and the listed commands and operations are executed in listed order.

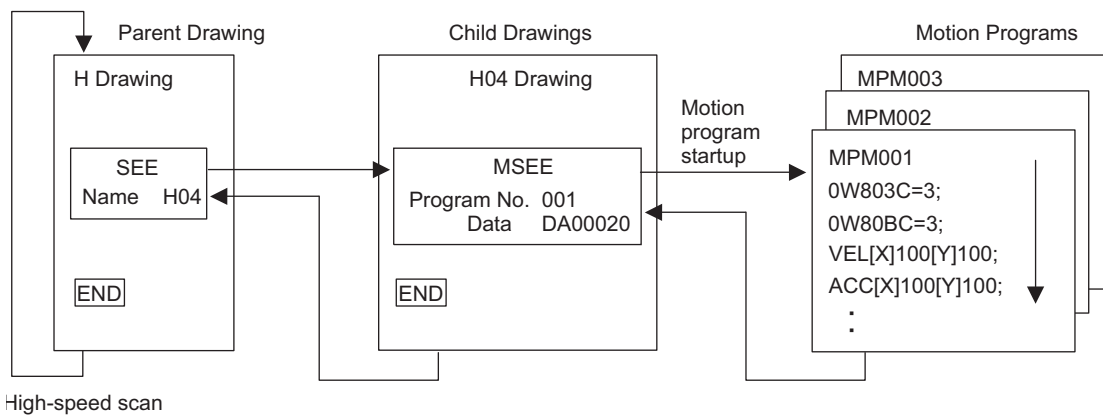

- Refer to 4.4.3 (5) *Sample Program Details* on page 4-56 for details of each program.
- A simple device is used in this example to describe the MP2300 system startup.
- This device has no power OFF circuit for the SERVOPACK in the event of emergency stops or overtravel. Include a proper emergency stop circuit in actual devices.

(3) H04 Drawing Tuning Panel

Display the H04 Drawing Tuning Panel as shown in 4.4.1 How to Open the Tuning Panel Window on page 4-44. Model system operation can be controlled by writing the current values for **Common operation** and **Positioning operation and settings** from the Tuning Panel.

No.	Data Name	S	Format	CurrentValue	Unit	Lower Limit	Upper Limit	REG-No.	DWG
1	***** Common monitor *****		XXXX	0000		0000	32767	DL00010	L
2	Axis 1 operation ready		ON/OFF	OFF				IB80000	
3	Axis 2 operation ready		ON/OFF	OFF				IB80800	
4	Axis 1 current position		XXXXXXXXXX	0000000000		-2147483648	2147483647	IL8016	
5	Axis 2 current position		XXXXXXXXXX	0000000000		-2147483648	2147483647	IL8096	
6	***** Common operation *****		XXXX	00000		00000	32767	DL00010	L
7	Servo ON PB	S	ON/OFF	ON				MB300000	
8	Alarm reset PB	S	ON/OFF	OFF				MB300001	
9	**** Positioning operation and settings ****		XXXX	00000		00000	32767	DL00010	L
10	Positioning, start	S	ON/OFF	OFF				DB000010	H04
11	Positioning, hold	S	ON/OFF	OFF				DB000011	H04
12	Positioning, abort	S	ON/OFF	OFF				DB000012	H04
13	Motion program No. setting	S	XXX	000		001	003	Dw000030	H04
14	1st target position (x axis)	S	XXXXXXXXXX	0000000000		-2147483648	2147483647	DL00010	H04
15	1st target position (y axis)	S	XXXXXXXXXX	0000000000		-2147483648	2147483647	DL00012	H04
16	2nd target position (x axis)	S	XXXXXXXXXX	0000000000		-2147483648	2147483647	DL00014	H04
17	2nd target position (y axis)	S	XXXXXXXXXX	0000000000		-2147483648	2147483647	DL00016	H04
18	MPM running		ON/OFF	OFF				MB300020	
19	MPM alarm		ON/OFF	OFF				MB300020	

(4) Procedure

Use the following procedure to operate the Tuning Panel and check operation.

1. Servo ON

Change the *Servo ON PB* current value from *OFF* to *ON*.

The Servomotor will turn ON and the Servo will be clamped.

2. Motion program No. setting

Enter a value from 1 to 3 as the current value for the *Motion Program No. setting* to specify the motion program to be executed.

- | | |
|-----------------|---|
| 001 (=PMP001): | Program for executing zero point return using Servomotor phase-C. When this program is executed, X axis (axis 1) and Y axis (axis 2) rotate a set distance once a phase-C pulse has been input, and then return home. |
| 002 (= PMP002): | Repeats the following two operations with an interval time.
1.) Moves to target position 1 in incremental mode, performs linear interpolation to target position 2, and then repeats this operation 5 times.
2.) In absolute mode, performs counterclockwise circular interpolation from current position to home (0,0) (once). |
| 003 (= PMP003): | Repeats the same operation as PMP002, but without an interval time. |
- ♦ No programs have been created for numbers 004 and higher. An MPM alarm will occur if 004 or higher numbers are entered and operation is started.

3. Set Target Position 1 and Target Position 2

Enter any value for the following settings. These settings determine the target position for positioning when Motion Program No. 2 and No. 3 are executed.

- 1st target position (X axis)
- 1st target position (Y axis)
- 2nd target position (X axis)
- 2nd target position (Y axis)

4. Positioning, start

Change the current value for *Positioning, start* from *OFF* to *ON*.

The program will be executed and the model system will operate according to the motion program set in step 2.

Once the operation has been checked, enter *OFF* and stop the system.

When a motion program starts, the current value for *MPM running* will change to *ON*. Also, when the Servo axis rotates, all *Current Values* will change.

- ♦ If an error occurs during motion program execution, the current value for *MPM alarm* in the Tuning Panel will change to *ON*. Use the following procedure to clear alarms.
 1. Set the current value for *Positioning, abort* to *ON* then *OFF*.
 2. Set the current value for *Alarm reset PB* to *ON* then *OFF*.
- ♦ It is necessary to create routines within the actual application program in order to monitor and control the registers corresponding to the signals and data listed in the table above.
- ♦ The register numbers that correspond to the signals used in this sample program will be the register numbers displayed under *REG-No.* next to *DWG* at the right of the Tuning Panel window.

(5) Sample Program Details

[a] H04 Drawing

The H04 child drawing contains the ladder program for managing and controlling MPM motion programs.

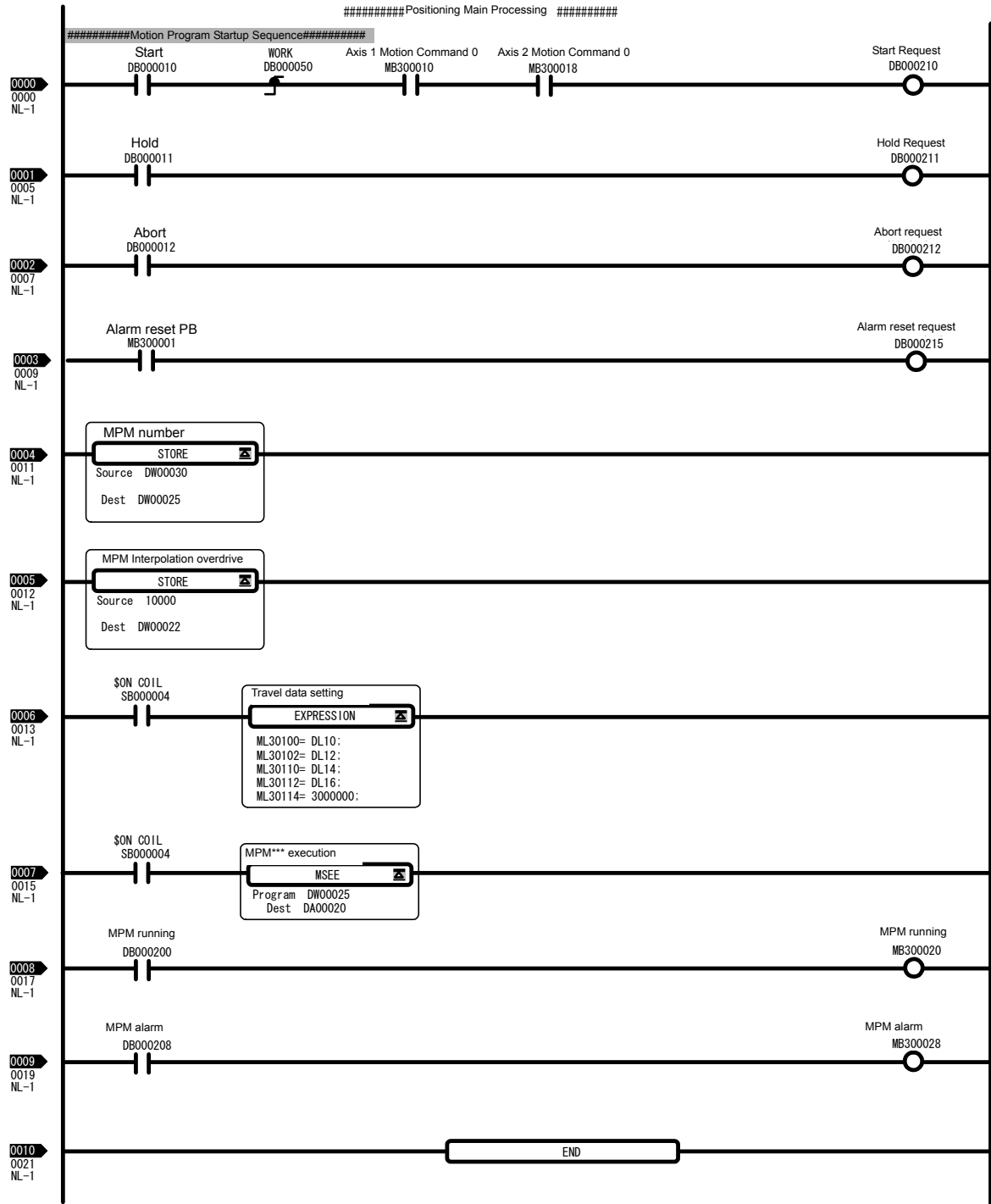

[b] Motion Program MPM001

The MPM001 motion program uses the Servomotor phase-C pulse to perform home return.

```

00001 "MPM001";
00002 OW803C=3;           "X axis home return method selection (3: Phase C)"
00003 OW80BC=3;          "Y axis home return type selection (3: Phase C)"
00004 VEL [X]1000 [Y]1000; "Travel speed setting for positioning command"
00005 ACC[X]100[Y]100;   "Acceleration time setting"
00006 DCC[X]100[Y]100;   "Deceleration time setting"
00007 OW803E=100;        "X axis approach speed (mm/min)"
00008 OW8040=50;         "X axis creep speed (mm/min)"
00009 OL8042=10000;      "X axis final travel distance (0.001 mm)"
00010 OW80BE=100;        "Y axis approach speed (mm/min)"
00011 OW80C0=50;         "Y axis creep speed (mm/min)"
00012 OL80C2=10000;      "Y axis final travel speed (0.001 mm)"
00013 ZRN[X]00[Y]00;     "Home return command"
00014 END;

```

(6) Motion Programs MPM002 and MPM003

Motion programs MPM002 and MPM003 perform positioning, linear interpolation, and circular interpolation for axis 2.

MPM002 inserts a timer command between each travel command to indicate operation divisions. MPM003 continuously executes travel commands, without the timer commands of MPM002, as shown in the following figure.

```

00001 "MPM002";
00002 "Data Setting";
00003 VEL [X]1000 [Y]1000; "Travel speed setting for positioning command"
00004 FMX T50000000;       "Composite speed upper limit setting for interpolation command"
00005 IAC T500;            "Acceleration time setting for interpolation command"
00006 IDC T500;            "Deceleration time setting for interpolation command"
00007 PLN [X][Y];          "Plane specification for circular interpolation command"
00008 INC;                  "Increment position command setting"
00009 TIM T100;
00010 "Repeat Operation"
00011 DW10 =0;
00012 WHILE DW10 <5;       "No. repeats = 5"
00013 MOV [X]ML30100 [Y]ML30102 ; "Positioning command"
00014 TIM T100;
00015 MVS [X]ML30110 [Y]ML30112 FML30114; "Linear interpolation command"
00016 TIM T100;
00017 ABS;                  "Absolute positioning command setting"
00018 MCC [X]0 [Y]0 R1000.0 FML30114; "Circular interpolation command"
00019 TIM T100;
00020 DW10 =DW10 +1;
00021 WEND;
00022 "End Repeat Operation";
00023 END;

```

4.4.4 Operation Check 3: Phase Control - Electronic Shaft

(1) Machine Outline

As shown in the following figure, the Servomotor performs the same operation as rolls No. 1 and No. 2 connected to the line shaft. No phase matching, however, is used.

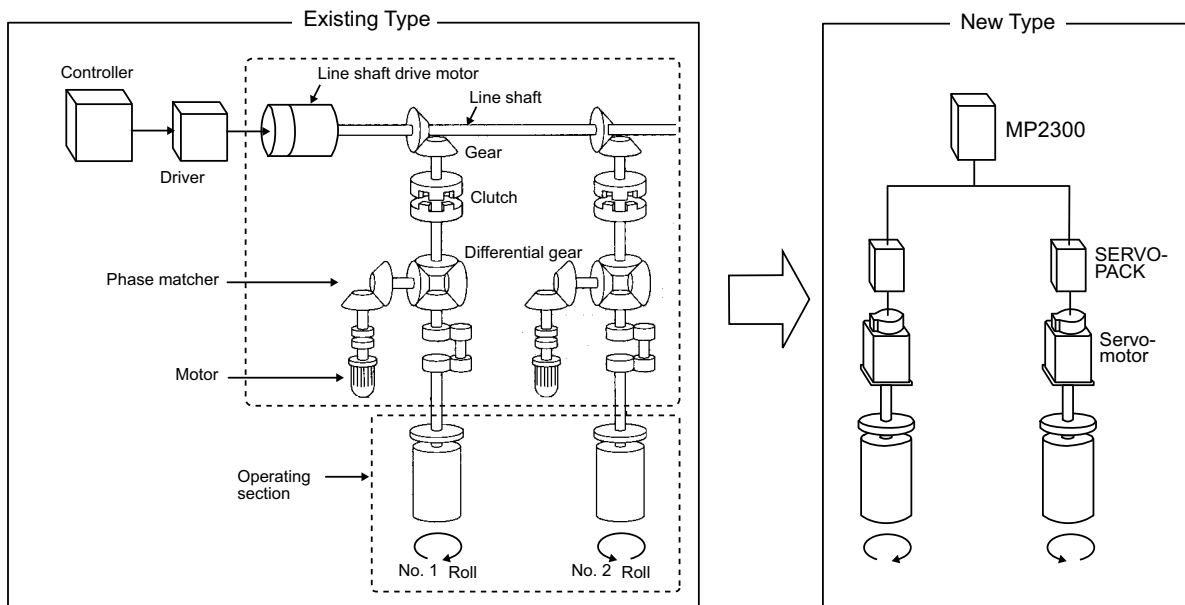

(2) Program Overview

Use the ladder program (H06.01 Drawing) to check the above operation. The two axes synchronize to a virtual master axis according to the entered speed settings, and axis 1 and axis 2 rotate in exactly the same way.

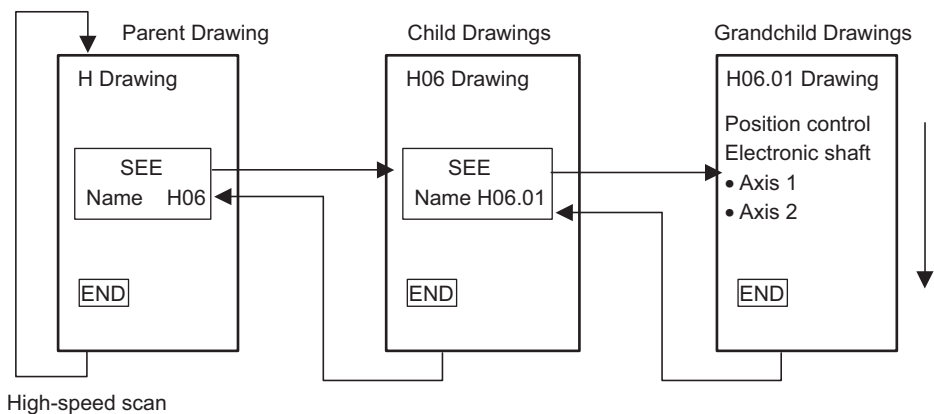

- Refer to 4.4.4 (5) Sample Program Details on page 4-60 for details of H06.01 Drawing.
- A simple device is used in this example to describe the MP2300 system startup.
- This device has no power OFF circuit for the SERVOPACK in the event of emergency stops or overtravel. Include a proper emergency stop circuit in actual devices.

(3) H06 Drawing Tuning Panel

Display the H06 Drawing Tuning Panel as shown in 4.4.1 *How to Open the Tuning Panel Window* on page 4-44.

Model system operation can be controlled by writing the current values for **Common operation** and **Phase control (electric shaft)** from the Tuning Panel.

N _o	Data Name	S	Format	Current Value	Unit	Lower Limit	Upper Limit	REG-No.	DWG
1	***** Common monitor *****		XXXXX	00000		00000	32767	DW00010	L
2	Axis 1 operation ready		ON/OFF	OFF				IB80000	
3	Axis 2 operation ready		ON/OFF	OFF				IB80800	
4	Axis 1 current position		XXXXXXXXXX	0000000000		-2147483648	2147483647	IL8016	
5	Axis 2 current position		XXXXXXXXXX	0000000000		-2147483648	2147483647	IL8096	
6	***** Common operation *****		XXXXX	00000		00000	32767	DW00010	L
7	Servo ON PB	S	ON/OFF	ON				MB300000	
8	Alarm reset PB	S	ON/OFF	OFF				MB300001	
9	***** Phase control (electric shaft) *****		XXXXX	00000		00000	32767	DW00010	L
10	Electric shaft start	S	ON/OFF	OFF				DB000010	H06.01
11	Speed setting (motor rated speed 30000mm/min)	S	XXXXXX	000000	mm/min	000000	030000	DL00010	H06.01
12	***** Phase control (electric cam) *****		XXXXX	00000		00000	32767	DW00010	L
13	Electric cam start	S	ON/OFF	OFF				DB000010	H06.02
14	Main axis speed setting(30000mm/min)	S	XXXXXX	000000	mm/min	-030000	030000	DL00010	H06.02
15	Cam axis: amplitude setting(double amplitude)	S	XXXXXX	*****	mm	000.000	999.999	ML30200	
16	Cam axis: main axis moving amount per a cycle	S	XXXXXX	*****	mm	00000.000	50000.000	ML30202	

(4) Procedure

Use the following procedure to operate the Tuning Panel and check operation.

1. Servo ON

Change the *Servo ON PB* current value from *OFF* to *ON*.

The Servomotor will turn ON and the Servo will be clamped.

2. Electronic Shaft Start

Change the *Electric shaft start* current value from *OFF* to *ON*.

The mode will change to the phase control (electronic shaft) mode. Enter *OFF* to exit position control (electric shaft) mode.

3. Enter Speed Settings

Enter any value within the setting range (0 to 30000) as the current value of *Speed setting (motor rated speed 30,000 mm/min)*.

This operation synchronizes the speed for both axes to the speed of the virtual master axis and operation starts.

Change the *Electric shaft start* current value from *ON* to *OFF* when the check operation has been completed.

- It is necessary to create routines within the actual application program in order to monitor and control the registers corresponding to the signals and data listed in the table above.
- The register numbers that correspond to the signals used in this sample program will be the register numbers displayed under *REG-No.* next to *DWG* at the right of the Tuning Panel window.

(5) Sample Program Details

[a] H06.01 Drawing

The H6.01 grandchild drawing shows the ladder program for controlling phase control (electronic shaft) operation.

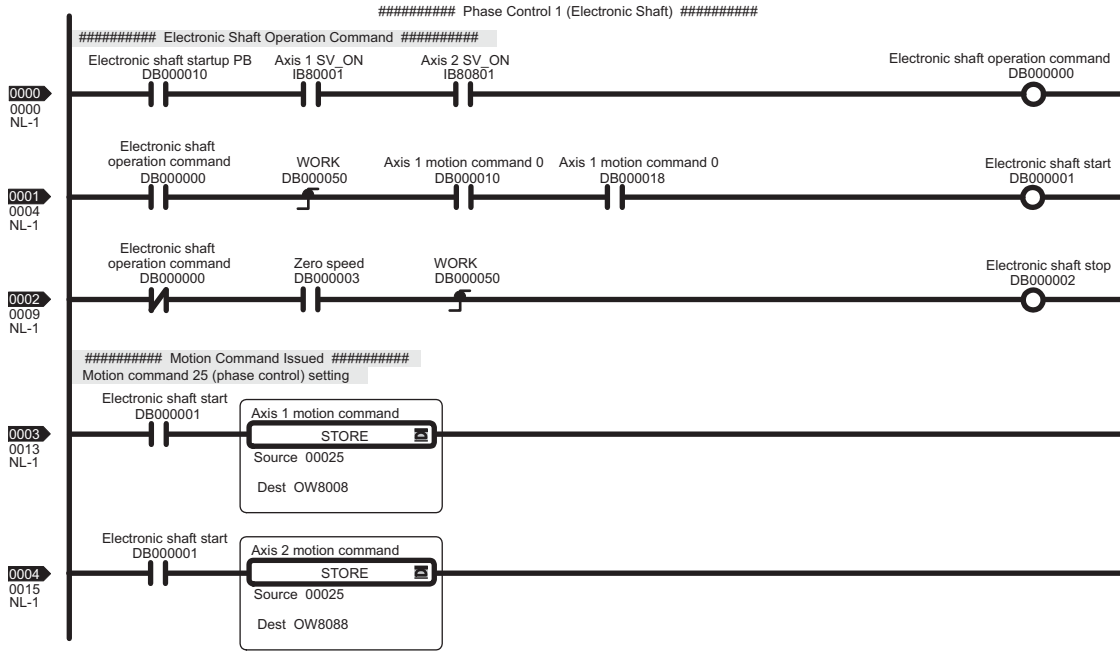

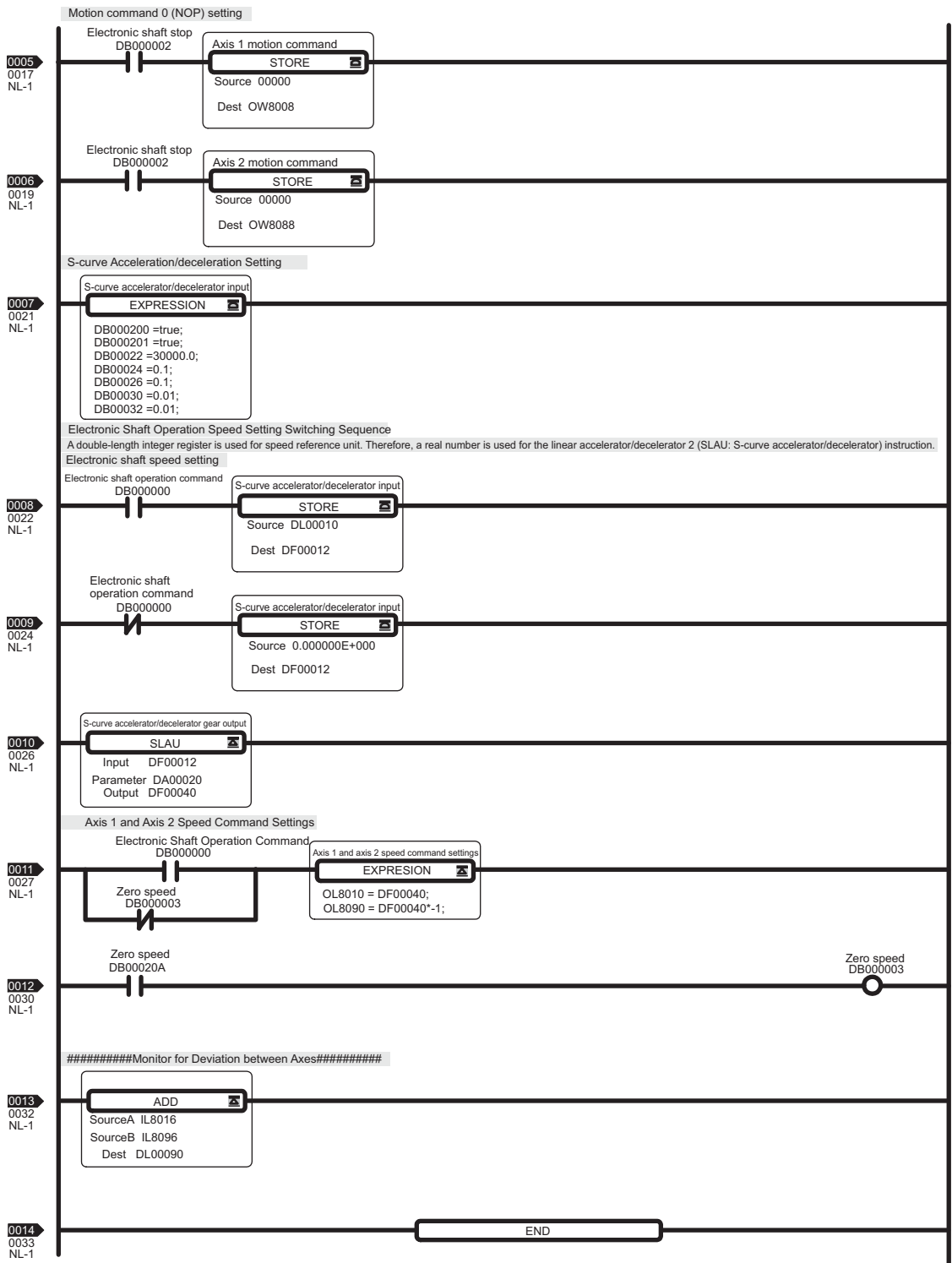

4.4.5 Operation Check 4: Phase Control - Electronic Cam

(1) Machine Outline

As shown in the following figure, the Servomotor performs the same operation as the mechanical cam synchronized to a roller connected to the line shaft. No phase matching is used.

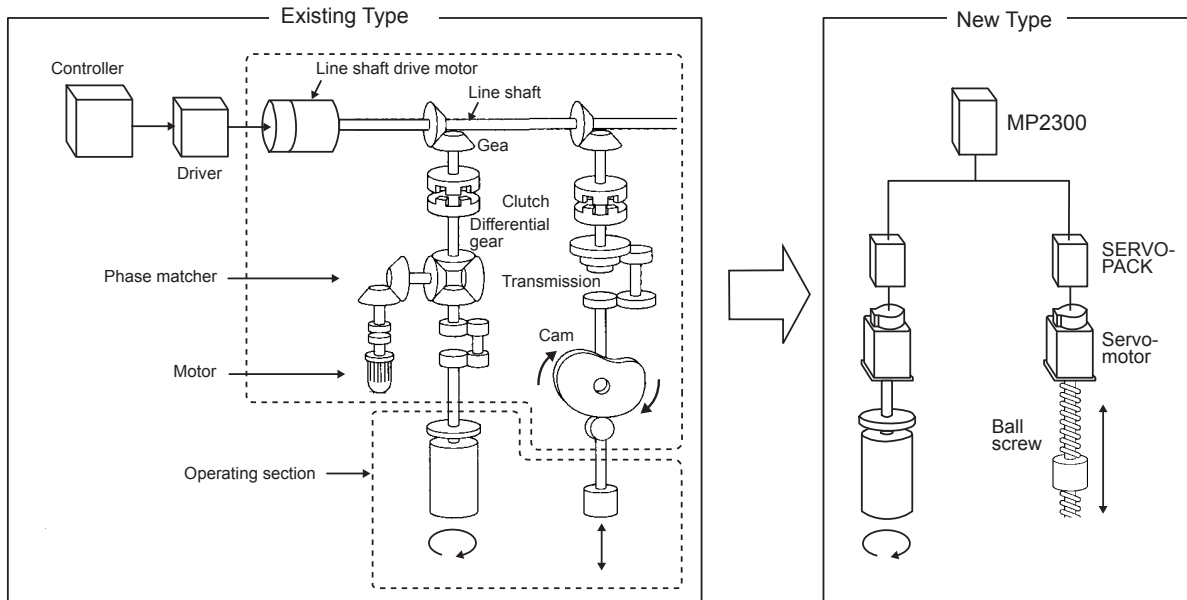

(2) Program Overview

Use the ladder program (H06.02 Drawing) to check the above operation.

The two axes rotate synchronized with the input speed setting. Axis 1 is the roll axis (Master axis) and axis 2 is the cam axis (Slave axis, which moves in COS cam pattern against Master axis).

Cam pattern data is created using a ladder program (L06 Drawing).

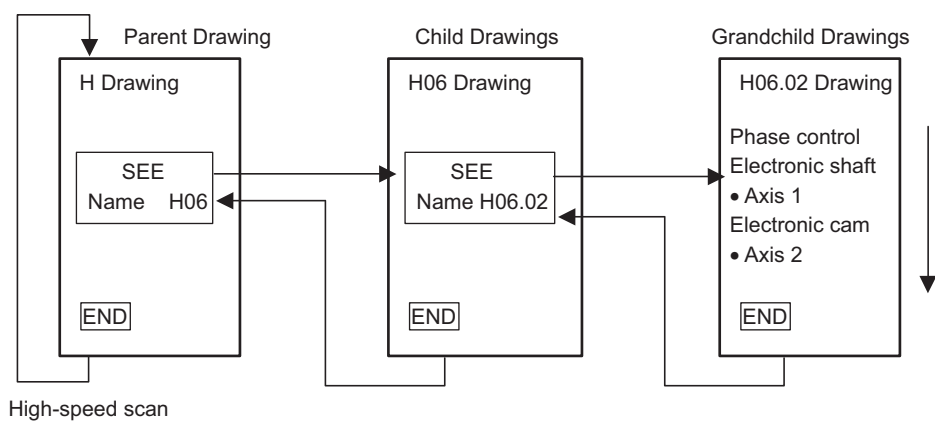

- Refer to 4.4.5 (5) Sample Program Details on page 4-64 for details of H06.01 Drawing.
- A simple device is used in this example to describe the MP2300 system startup. Caution is required because actual applications will be different.
- This device has no power OFF circuit for the SERVOPACK in the event of emergency stops or overtravel. Include a proper emergency stop circuit in actual applications.

(3) H06 Drawing Tuning Panel

Display the H06 Drawing Tuning Panel as shown in 4.4.1 *How to Open the Tuning Panel Window* on page 4-44.

Model system operation can be controlled by writing the current values for **Common operation** and **Phase control (electric shaft)** from the Tuning Panel.

No	Data Name	S	Format	CurrentValue	Unit	Lower Limit	Upper Limit	REG-No.	DWG
1	***** Common monitor *****		XXXXX	00000		00000	32767	DW00010	L
2	Axis 1 operation ready		ON/OFF	OFF				IB80000	
3	Axis 2 operation ready		ON/OFF	OFF				IB80800	
4	Axis 1 current position		XXXXXXXXXX	0000000000		-2147483648	2147483647	IL8016	
5	Axis 2 current position		XXXXXXXXXX	0000000000		-2147483648	2147483647	IL8096	
6	***** Common operation *****		XXXXX	00000		00000	32767	DW00010	L
7	Servo ON PB	S	ON/OFF	OFF				MB30000	
8	Alarm reset PB	S	ON/OFF	OFF				MB30000	
9	***** Phase control (electric shaft) *****		XXXXX	00000		00000	32767	DW00010	L
10	Electric shaft start	S	ON/OFF	OFF				DB00001	H06.01
11	Speed setting (motor rated speed 30000mm/min)	S	XXXXXX	000000	mm/min	000000	030000	DL00010	H06.01
12	***** Phase control (electric cam) *****		XXXXX	00000		00000	32767	DW00010	L
13	Electric cam start	S	ON/OFF	OFF				DB00001	H06.02
14	Main axis speed setting(30000mm/min)	S	XXXXXX	000000	mm/min	-030000	030000	DL00010	H06.02
15	Cam axis: amplitude setting(double amplitude)	S	XXX.XXX	000.000	mm	000.000	999.999	ML30200	
16	Cam axis: main axis moving amount per a cycle	S	XXXXX.XXX	00000.000	mm	00000.000	50000.000	ML30202	

(4) Procedure

1. Servo ON

Change the *Servo ON PB* current value from *OFF* to *ON*.

The Servomotor will turn ON and the Servo will be clamped.

2. Enter Cam Data

Enter any value within the setting range to *Cam axis: amplitude setting (double amplitude)* and *Cam axis: main axis moving amount per cycle*. These settings create the cam pattern.

- Cam axis: amplitude setting (double amplitude), Setting range: 0 to 999.999
- Cam axis: main axis moving per cycle, Setting range: 0 to 50000.000

Cam pattern data is not changed when *Electric cam start* is set to ON.

3. Start Electronic Cam Operation

Change the *Electric cam start* current value from *OFF* to *ON*.

Axis 2 will change to phase control (electric cam) mode. Enter OFF to exit phase control (electric cam) mode.

4. Enter Main Axis Speed Settings

Enter any value within the setting range (−30000 to 30000) as the current value for *Main axis speed setting*.

This operation sets the master axis speed and starts operation.

Change the *Electric cam start* current value from *ON* to *OFF* when the check operation has been completed.

- It is necessary to create routines within the actual application program in order to monitor and control the registers corresponding to the signals and data listed in the table above.
- The register numbers that correspond to the signals used in this sample program will be the register numbers displayed under *REG-No.* next to *DWG* at the right of the Tuning Panel window.

(5) Sample Program Details

[a] H06.02 Drawing

The H06.02 grandchild drawing controls phase control (electronic cam) operation.

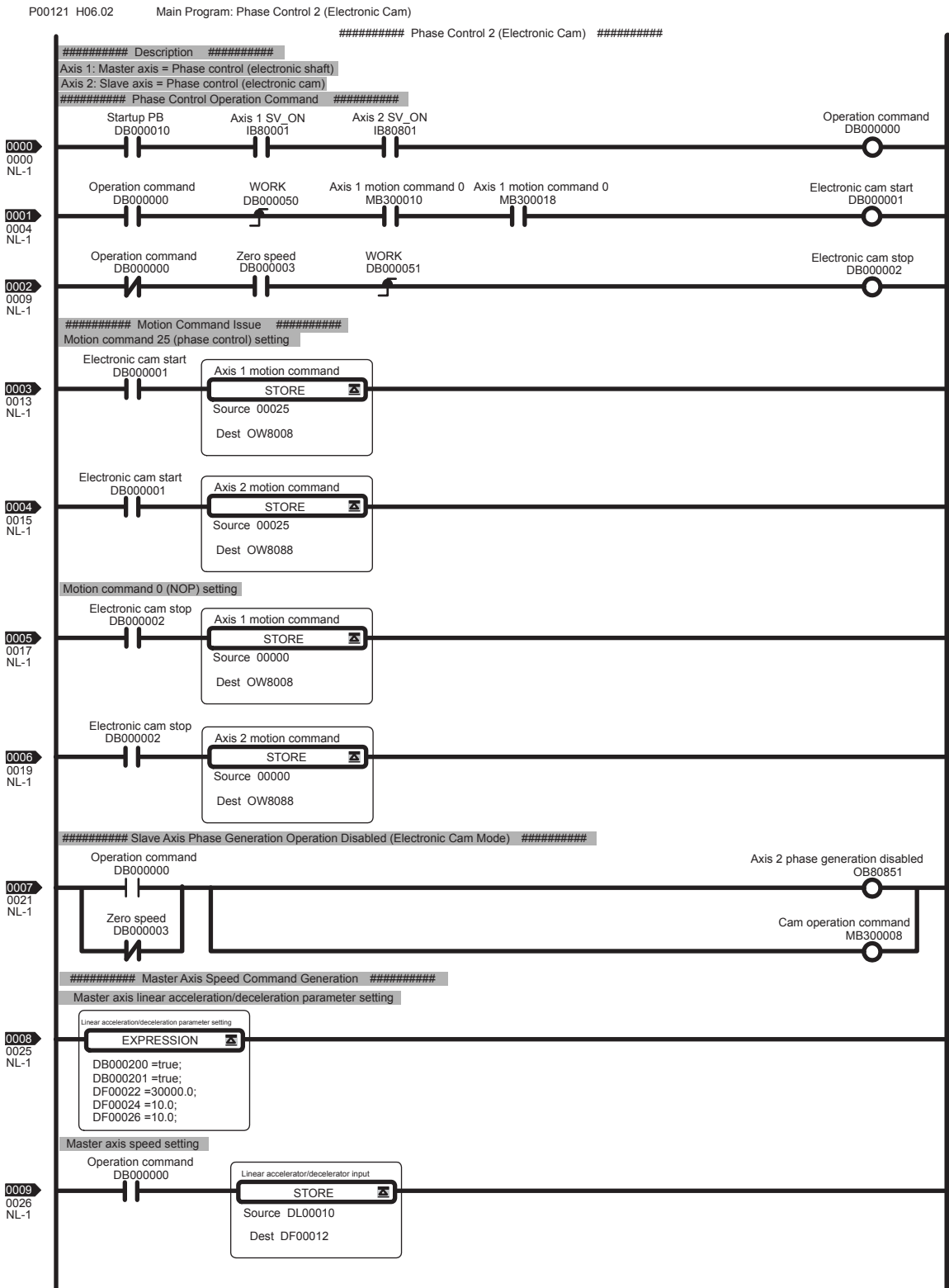

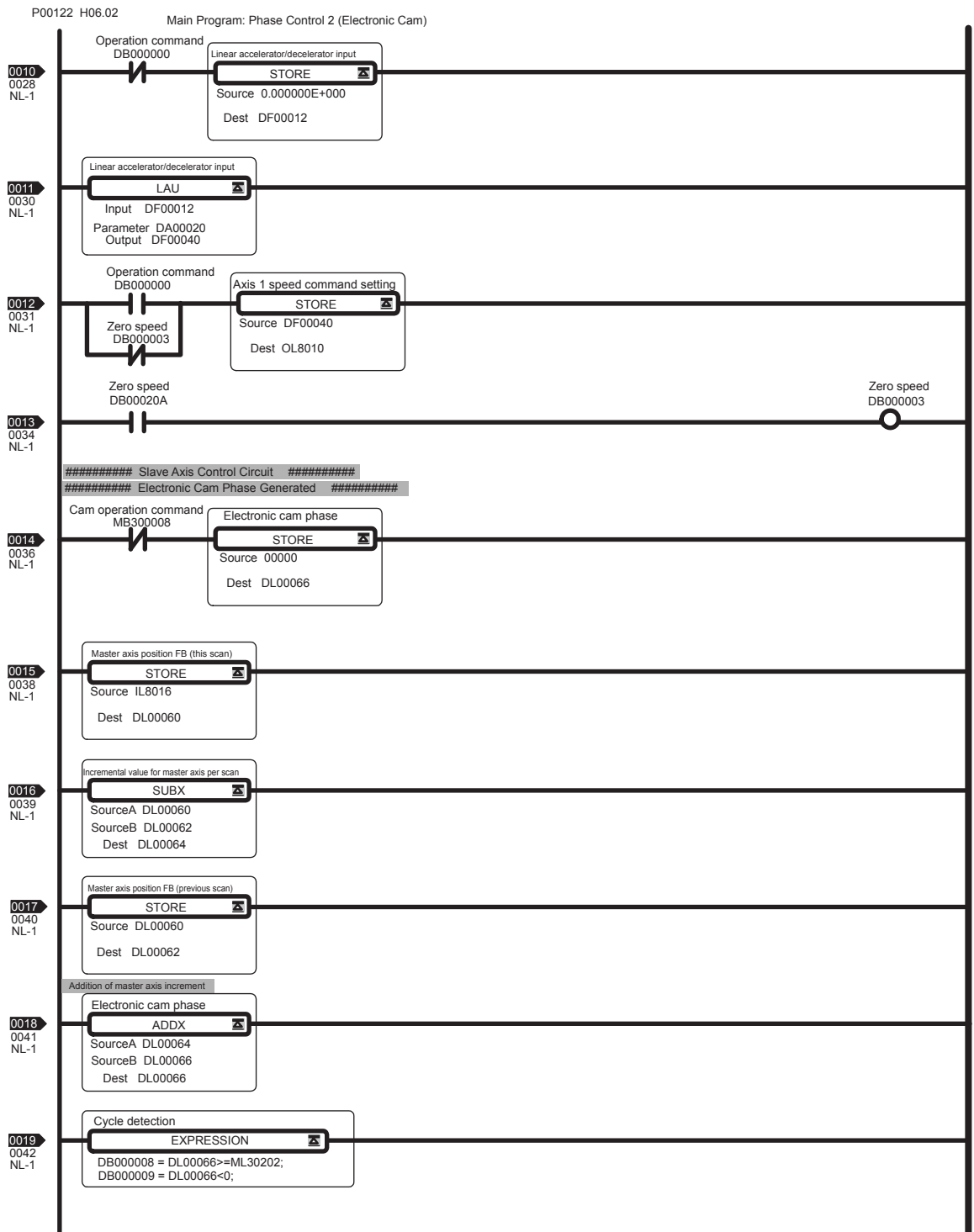

4.4.5 Operation Check 4: Phase Control - Electronic Cam

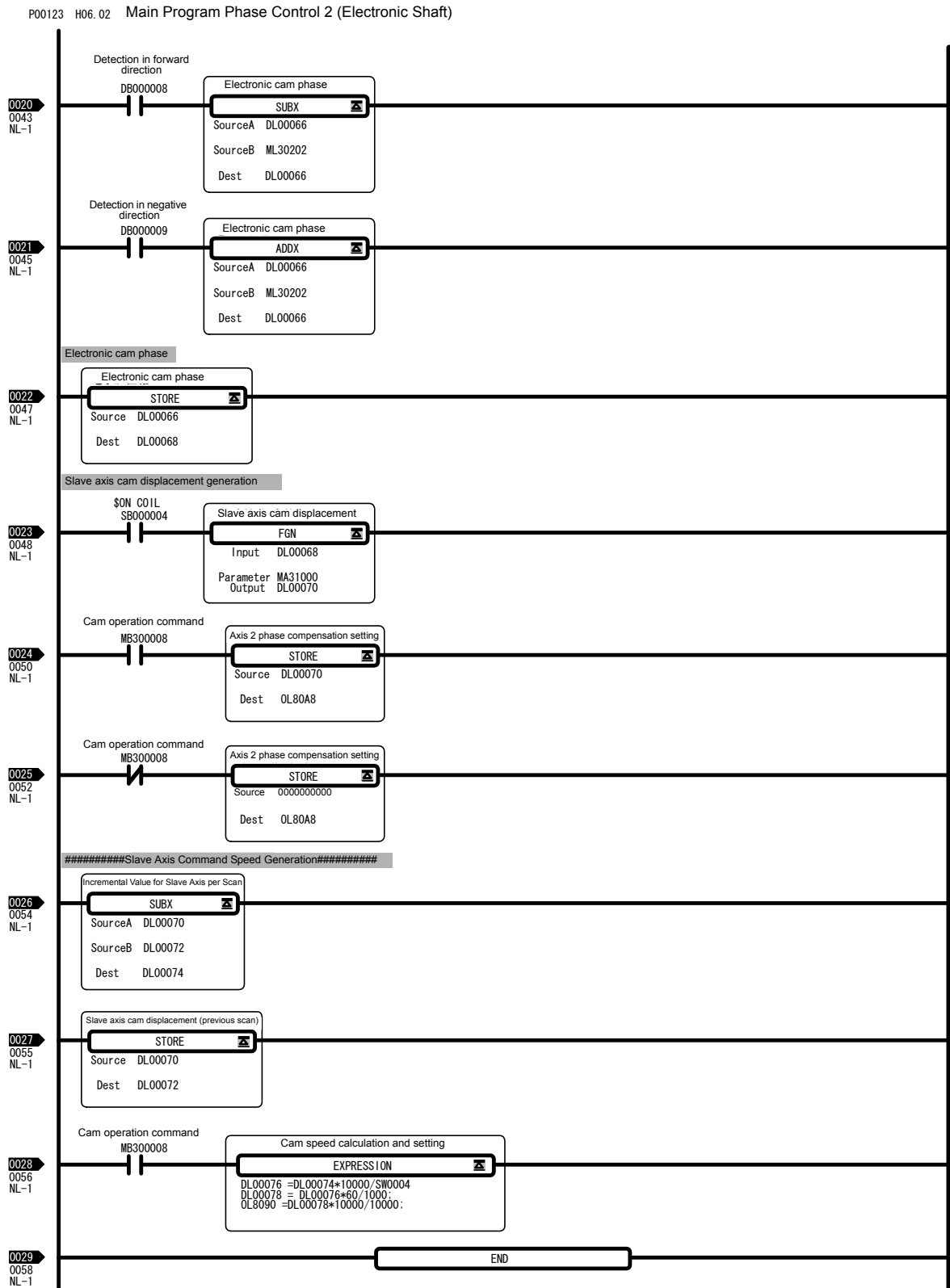

[b] L Drawing

The L parent drawing manages the low-speed scan that controls the overall sample program.

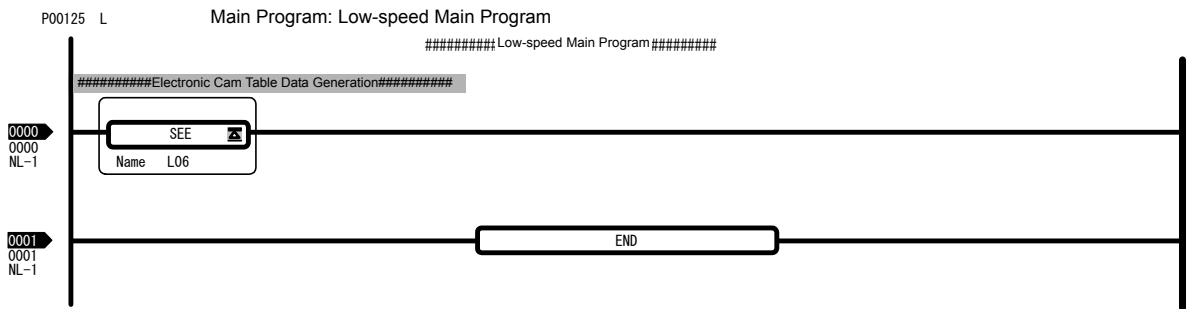

[c] L06 Drawing

The L06 child drawing creates cam pattern data for phase control (electronic cam).

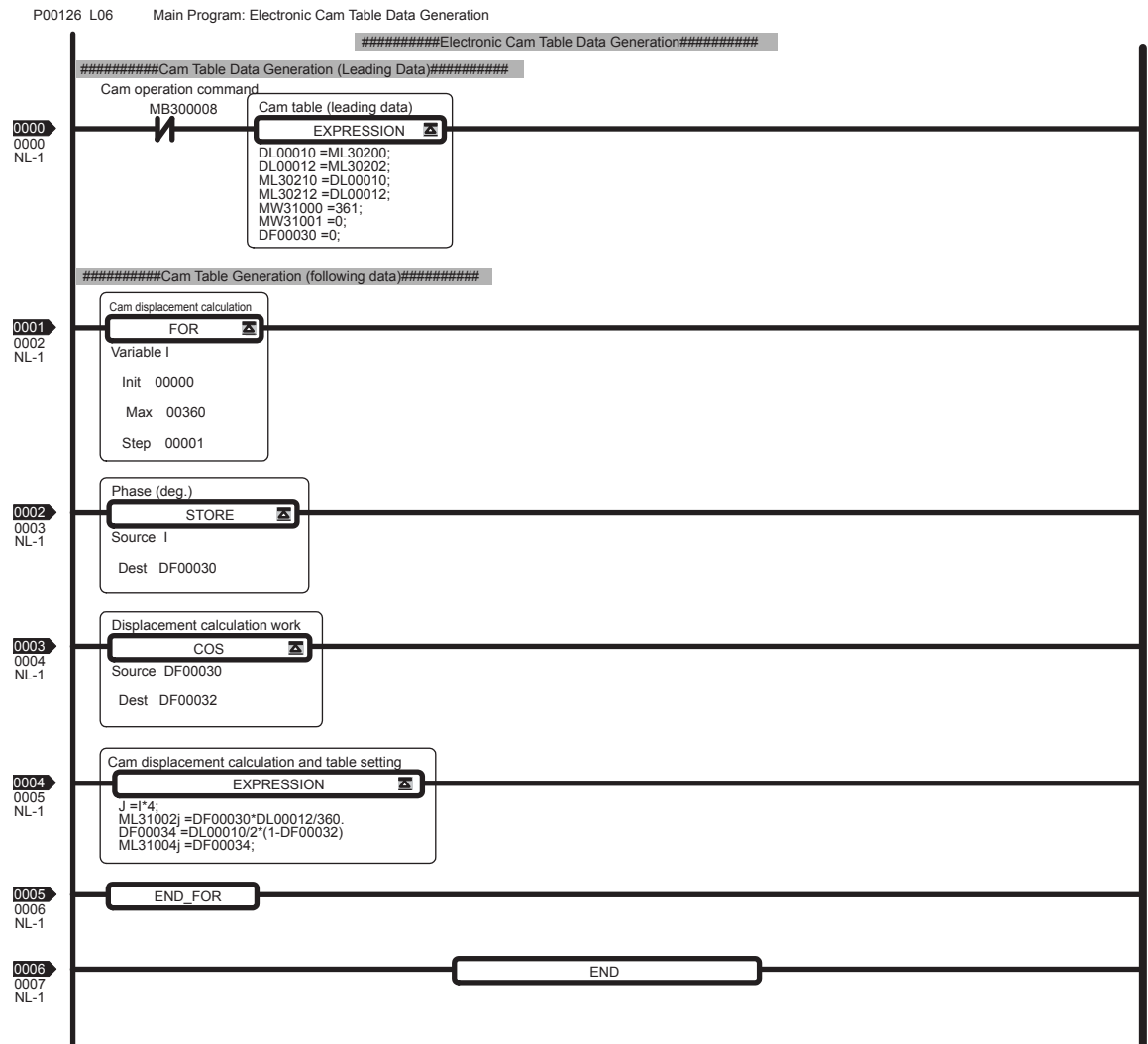

4.5 System Startup Using Self-Configuration

System startup time can be reduced by using self-configuration.

This section describes system startup using self-configuration, in the following three circumstances.

- Starting the system for first time
- Adding an electronic device (e.g., SERVOPACK or Distributed I/O Module)
- Replacing electronic devices

4.5.1 Starting the System for First Time

Use the following procedure to startup a new system.

1. Wire and Connect Electronic Devices.

Correctly wire and connect all electronic devices to be used.

2. Make Switch Settings for MECHATROLINK Slaves.

Set the MECHATROLINK communication specifications using the DIP switch and the station address on the rotary switch on each MECHATROLINK slaves.

Example SERVOPACK Settings (SGDS-□□□1□□)

SW1	Name	Setting	Contents	Default
Bit 1	Baud rate	OFF	4 Mbps	ON
		ON	10 Mbps	
Bit 2	No. of transmission bytes	OFF	17	ON
		ON	32	
Bit 3	Station address	OFF	Station address = 40H+SW1	OFF
		ON	Station address = 50H+SW1	
Bit 4	Reserved (Reserved by the system.)	OFF	—	OFF

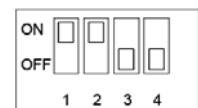

SW2 (default setting)

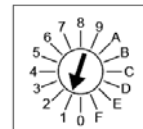

SW1 (default setting)

- Refer to each slaves manual for information on the setting details.

3. Start Up MECHATROLINK Slaves.

Turn ON the power to the MECHATROLINK slaves and check that the electronic devices start up normally.

- If using a new Absolute Encoder, the Absolute Encoder will need to be initialized. Refer to *C Initializing the Absolute Encoder* on page A-13 for details.
- The servo adjustment can be performed either in this step or after the self-configuration.

4. Set the Switches on MP2300/Optional Module

Set the switches of SW1 on MP2300 as shown below.

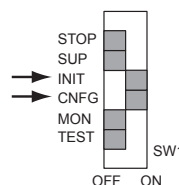

Make switch settings for communication and station address on each Optional Module mounted on the MP2300 as required.

5. Execute Self-configuration.

Check that all MECHATROLINK slaves have started up normally, then turn ON the power to the MP2300 to start self-configuration.

The LED indicators on the MP2300 Basic Module change as shown below.



When self-configuration is executed, the MP2300 will detect connected MECHATROLINK slaves, make I/O register allocations for them, and automatically set motion parameters to enable minimum operation.

- Self-configuration is designed to immediately enable operation to the Servo. Therefore, the SERVOPACK overtravel function (refer to 11.2 Overtravel Function in Machine Controller MP2000 Series Built-in SVB/SVB-01 Motion Module User's Manual (Manual No.: SIEPC88070033)) is disabled. When actually operating machinery, overtravel must be enabled each SERVOPACK.

6. Make Parameter Settings to Match the Machinery.

Start MPE720, then set and save fixed parameters relating to reference units (fixed parameters 4, 5, 6, 8, and 9). Adjust the servo gains, etc. if servo tuning was not performed in step 3.

- Refer to 4.2.1 (2) Starting MPE720 Ver 6.□□ To Transfer the Sample Program to the MP2300 on page 4-14, 4.2.2 Setting Motion Fixed Parameters and Adjusting the Settings for Servo Control on page 4-17 (when using MPE720 Ver 6.□□), 4.3.1 Starting MPE720 Ver 5.□□ and Creating Folders on page 4-24 and 4.3.2 Reading Sample Programs and Setting and Saving Parameters on page 4-28 (when using MPE720 Ver 5.□□) for the procedure from starting MPE720 to setting and saving fixed parameters.
- Refer to D.1 Fixed Parameter List on page A-19 for the fixed parameter list, and Machine Controller MP2000 Series Motion Module Built-in SVB/SVB-01 User's Manual (Manual No. : SIEPC88070033) for details on fixed parameters and for information on setting parameters for machinery.
- Refer to each SERVOPACK manual for information on the Servo adjustment.

7. Make Servo Adjustment and Save SERVOPACK Parameters.

Adjust the SERVOPACK gain and other parameters for each SERVOPACK and save the SERVOPACK parameters for each axis to the MP2300.

- Select the axis in the **SVB Definition** Window (refer to 4.2.2 Setting Motion Fixed Parameters and Adjusting the Settings for Servo Control on page 4-17 or 4.3.2 (4) Set and Save Motion Fixed Parameters on page 4-36) , then click the **SERVOPACK** Tab to display the **SERVOPACK** Tab Page.

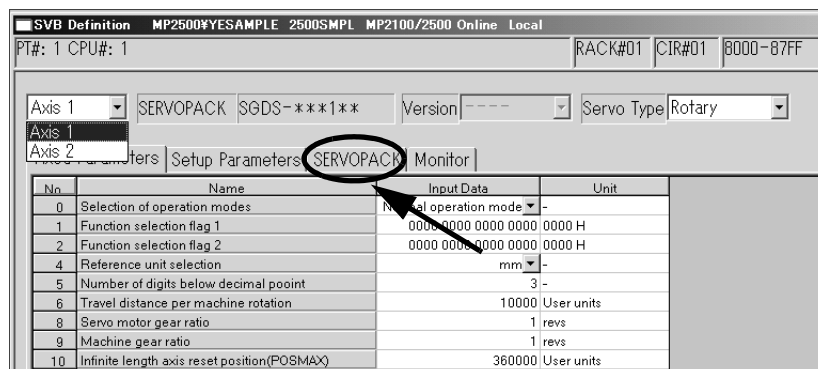

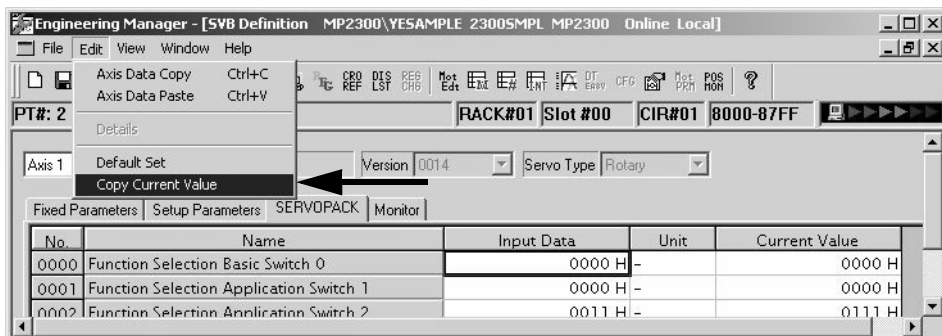
b) Select **Edit - Copy Current Value**.

- The data in the *Input Data* column in the SERVOPACK data saved to the MP2300 and the data in the *Current Value* column is the data set to the SERVOPACK.
- Refer to *B Current Values and Set Values (Input Data) in the SVB Definition Window* on page A-5 for information on the relationship between *Current Value* and *Input Data*.
- c) Select **File - Save** to save the SERVOPACK settings for the axis to the MP2300.

8. Save MP2300 Data to Flash Memory.

Return to the MPE720 File Manager Window and save to flash memory.

- Refer to 4.2.3 (1) *Saving to Flash Memory* on page 4-21 or 4.3.2 (6) *Saving to Flash Memory* on page 4-40 for information on how to save to flash memory.

9. Save Ladder Programs and Restart MP2300

Transfer the ladder program to the MP2300 and save to flash memory, and then turn the power from OFF to ON to restart the MP2300.

- Refer to 4.3.2 (3) *Transfer Individual Programs* on page 4-34 for information on transferring ladder programs.

This completes the system startup procedure.



- Always save to flash memory when applications have been changed, e.g., the ladder program changed or parameters set. The added information will be lost if not saved to flash memory and the power is turned OFF. If the information is lost, load the application remaining on the hard disk of the personal computer to the MP2300 and save to flash memory.
- It is recommended that applications are backed up at appropriate times. Applications can be backed up as follows:
MPE720 Ver 6.□□ : Select **Online - Read from Controller** in the main window.
MPE720 Ver 5.□□ : Log on online and select **Transfer - All Files - From Controller to MPE720**.

4.5.2 System Startup when Adding Electronic Devices

Use the following procedure to start the system when adding SERVOPACKs, Optional Modules, and other electronic devices.

1. Back Up Applications.

Before adding the electronic devices, create a backup of the application.

- For information on how to create a backup, refer to 4.2.3 (2) *Transferring Data from the MP2300 to Your Computer* on page 4-22 (MPE720 Ver 6.□□) or 4.3.2 (7) *Dumping All Data* on page 4-41 (MPE720 Ver 5.□□).

2. Turn OFF the MP2300.

Once the application has been backed up, log off from the MP2300 or disconnect the communication, and turn OFF the MP2300 power.

3. Start the Electronic Device to Be Added.

Make the DIP and rotary switch settings for the device to be added, then turn ON the power to that device only. Check that it starts up normally. Once normal startup has been confirmed, turn OFF the power supply.

4. Connect the Electronic Device.

Connect the electronic device to the MP2300 and turn ON the power to all the MECHATROLINK slaves.

5. Execute Self-configuration.

Turn ON the power to the MP2300, connect to the MP2300 using MPE720, then select **Order - Self Configure All Modules** to execute self-configuration for the added Optional Module or the SERVOPACK connected SVB Module.

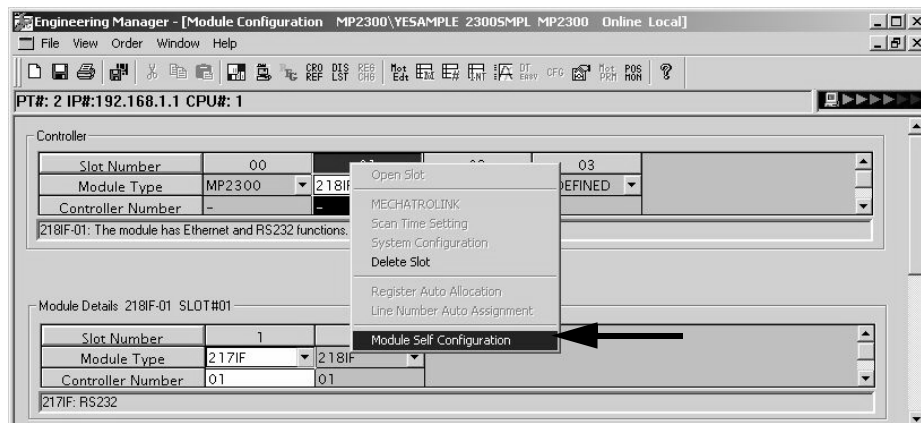

- Refer to 5.4.3 (2) *Self Configuration of Each Module* on page 5-34 for information on self-configuration of MP2300 Modules.
- If **Self Configure All Modules** is executed when MP2300 is selected, all the modules will be self-configured.
- With the self-configuration function, existing definitions for SERVOPACKs are not refreshed and existing parameters are saved. However, SERVOPACKs need to be started up normally for self-configuration to be used..



- If I/O addresses are changed for an existing application using MPE720 after the initial self-configuration has been executed, the I/O addresses are updated when self-configuration is subsequently executed. If SVR is set to disabled, the setting will return to enabled. It is recommended that settings are checked again, including settings for existing electronic devices, after self-configuration has been executed.

Refer to steps 6 to 9 under 4.5.1 *Starting the System for First Time* on page 4-68 for details of the rest of this procedure (steps 6 to 9).

- 6.** Make Parameter Settings to Match Machinery.
- 7.** Save SERVOPACK Parameters.
- 8.** Save MP2300 Data to Flash Memory.
- 9.** Save Ladder Programs and Restart MP2300.

This completes the system startup procedure when electronic devices have been added.

4.5.3 System Startup when Replacing Electronic Devices

Use the following procedure to start the system when replacing SERVOPACKs, Optional Modules, and other electronic devices due to malfunctions and other causes.

1. Back Up Applications.

Before replacing the electronic devices, create a backup of the application using MPE720.

- Refer to 4.3.2 (2) *Loading the Sample Programs* on page 4-32 (MPE720 Ver 6.□□) or 4.3.2 (7) *Dumping All Data* on page 4-41 (MPE720 Ver 5.□□) for information on how to create a backup.

2. Turn OFF the MP2300.

Log off from the MP2300 or disconnect the communication and turn OFF the MP2300 power.

3. Start the Electronic Device to Be Added.

Make the DIP and rotary switch and other settings for the new electronic device.

For MECHATROLINK slaves, make the switch settings, turn ON the power to the slave, and check that it starts up normally. Once normal startup has been confirmed, turn OFF the power supply.

4. Replace the Electronic Device.

Remove the electronic device to be replaced, connect the new device to the MP2300, and turn ON the power to all MECHATROLINK slaves.

5. Turn ON the MP2300.

Turn ON the MP2300 power.

6. Save SERVOPACK Parameters.

If a SERVOPACK has been replaced, use the following procedure to write the SERVOPACK parameters saved to the MP2300 to the new SERVOPACK.

- Select the axis, then select the **SERVOPACK** Tab Page on the **SVB Definition** Window (refer to 4.2.2 *Setting Motion Fixed Parameters and Adjusting the Settings for Servo Control* on page 4-17 or 4.3.2 (4) *Set and Save Motion Fixed Parameters* on page 4-36) to display the **SERVOPACK** Tab Page.

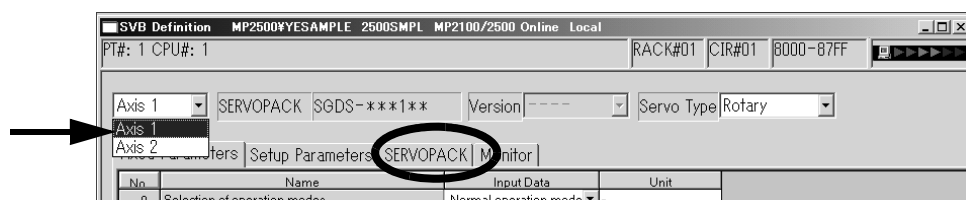

- Click **File - Save** to write the SERVOPACK settings to the SERVOPACK.

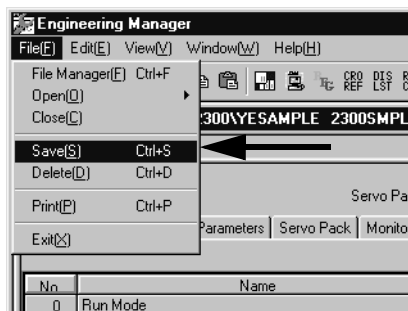

- The MP2300 SERVOPACK settings data is written to all SERVOPACKs when **Save** is executed, and the settings data is also written in the MP2300 *Current Value* data column.

7. Turn ON the MP2300 and SERVOPACKs

Turn ON (OFF to ON) the power to the MP2300 and SERVOPACKs and then enable the parameters written to the SERVOPACKs.

This completes the system startup procedure when electric devices have been replaced.

Outline of Motion Control Systems

This chapter describes the basic operation of MP2300 Motion Control Systems and provides an outline of user programs and registers.

5.1 Startup Sequence and Basic Operation	5-2
5.1.1 DIP Switch Settings	5-2
5.1.2 Startup Sequence	5-3
5.1.3 Startup Sequence Operation Details	5-4
5.1.4 LED Indicator Details	5-5
5.2 User Programs	5-6
5.2.1 Ladder Drawings (DWG)	5-6
5.2.2 Execution Control of Drawings	5-7
5.2.3 Motion Programs	5-10
5.2.4 Motion Programs and MSEE and S Registers	5-12
5.2.5 Example of Ladder Programs for Motion Program Control	5-18
5.2.6 Functions	5-20
5.3 Registers	5-21
5.3.1 Types of Registers	5-21
5.3.2 Data Types and Register Specifications	5-24
5.3.3 Using i and j Subscripts	5-26
5.3.4 Register Specification Methods	5-27
5.4 Self-configuration	5-28
5.4.1 Self-configuration Processing Procedure	5-29
5.4.2 Execution Procedure for Self-configuration Using the DIP Switch	5-30
5.4.3 Execution Procedure for Self-configuration Using MPE720	5-32
5.4.4 Definition Data Refreshed by Self-configuration	5-36
5.5 Precautions When Using the MP2300	5-38
5.5.1 Precautions when Setting or Changing User Definition Files	5-38
5.5.2 Precautions when Setting or Changing Module Configuration Definition Files	5-39
5.5.3 Setting and Changing the Scan Time	5-40

5.1 Startup Sequence and Basic Operation

This section describes the MP2300 startup sequence and basic operation together with the DIP switch settings, self-diagnosis at startup, and LED indicator patterns.

5.1.1 DIP Switch Settings

Set the DIP switch on the Basic Module to control operations of the startup sequence. The six switches are provided on the DIP switch on the Basic Module as shown in the figure below. The following table lists the functions of six switches.

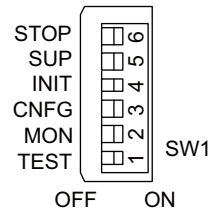

No.	Switch Name	Status	Operating Mode	Default Setting	Remarks
1	STOP	ON	User program stops	OFF	Set to ON to stop user program operation. Effective only at power ON.
		OFF	User program operation		
2	SUP	ON	System use	OFF	Always set to OFF.
		OFF	Normal operation		
3	INIT	ON	Memory clear	OFF	Set to ON to clear memory. Programs stored in flash memory will be run when Memory Clear is set to OFF.
		OFF	Normal operation		
4	CNFG	ON	Configuration mode	OFF	Set to ON for self-configuration of connected devices.
		OFF	Normal operation		
5	MON	ON	System use	OFF	Always set to OFF.
		OFF	Normal operation		
6	TEST	ON	System use	OFF	Always set to OFF.
		OFF	Normal operation		

5.1.2 Startup Sequence

The startup sequence for the MP2300 from the moment when the power has been turned ON is shown in the following flowchart.

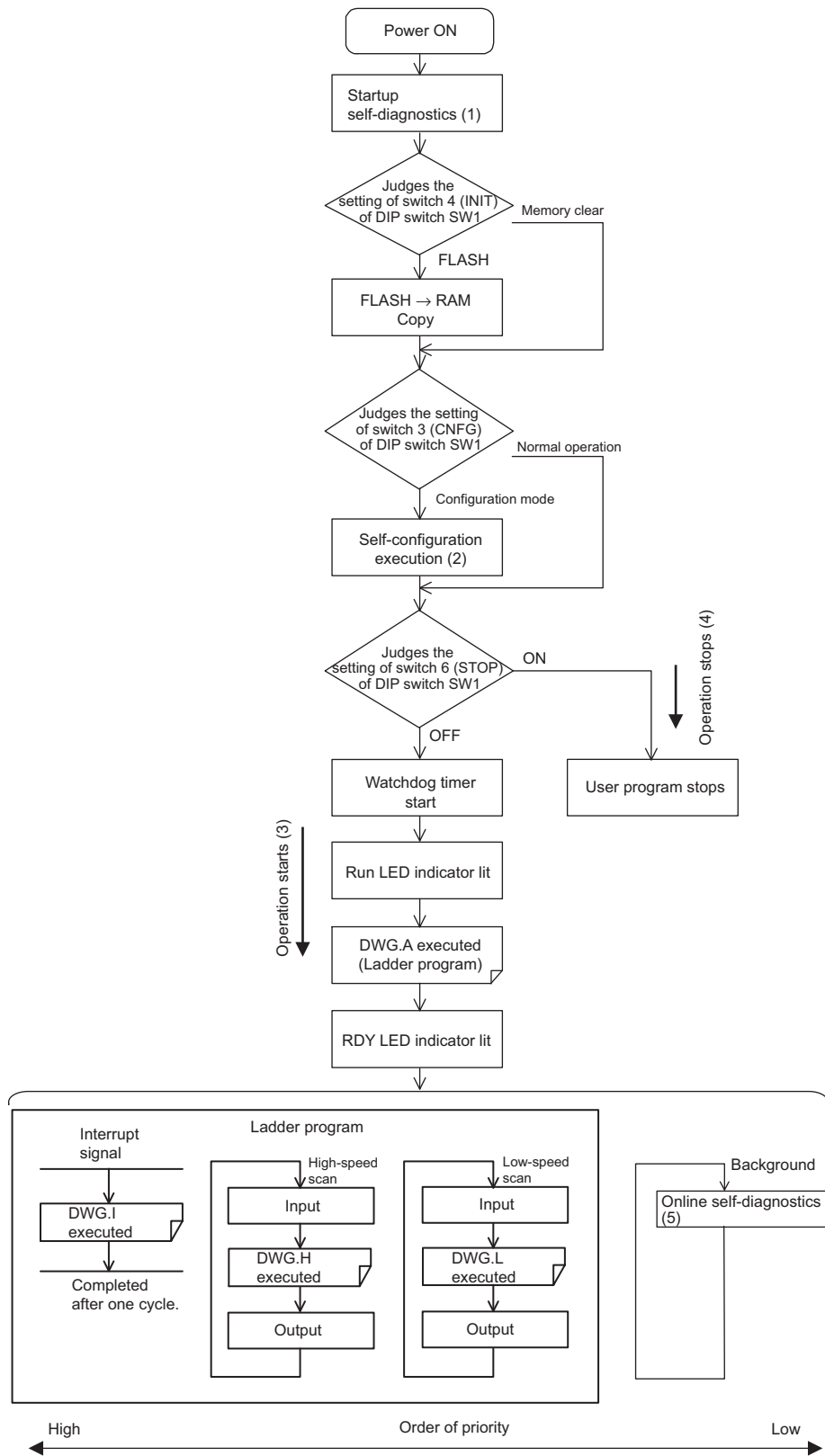

* Refer to 5.1.3 Startup Sequence Operation Details on the next page for details on (1) to (5).

5.1.3 Startup Sequence Operation Details

(1) Self-diagnosis at Startup

Self-diagnosis is performed on the following items after the power is turned ON.

- Read/write diagnosis of memory (RAM)
- System program (ROM) diagnosis
- Main processor (CPU) function diagnosis
- Floating Point Unit (FPU) function diagnosis

If diagnosis results in an error, the ALM and ERR LED indicators will blink red for the specified number of times. Refer to *5.1.4 LED Indicator Details* on page 5-5.

(2) Self-configuration

Self-configuration automatically recognizes the connected Optional Modules, and automatically creates a definitions file. For details, refer to *5.4 Self-configuration* on page 5-28.

The RUN LED indicator will blink green during execution of self-configuration.

(3) Operation Start

When the STOP switch is set to OFF (RUN) or changes from ON (STOP) to OFF (RUN), the CPU starts the watchdog timer and then executes DWGA in the ladder program. Refer to the startup processing drawing and *5.2.2 Execution Control of Drawings* on page 5-7.

First scan processing is executed once DWGA has been completed and the high-speed or low-speed scan time has elapsed. System I/O are executed from the first scan.

(4) Operation Stop

MP2300 stops motion control operation when the STOP switch is ON (STOP) and in the following circumstances.

Cause	Restart method
Power supply turned OFF	Turn ON the power again.
Power interruption	
Fatal error	Check the LED indicator for the cause of the error and then turn the power OFF then ON.
STOP executed from MPE720	Execute RUN from MPE720 .

(5) Online Self-diagnosis

Self-diagnosis is performed on the following items when the user logs on online.

- System program (ROM) diagnosis
- Main processor (CPU) function diagnosis
- Floating Point Unit (FPU) function diagnosis

If diagnosis results in an error, the ALM and ERR LED indicators will blink red for the specified number of times. Refer to *5.1.4 LED Indicator Details* on page 5-5.

5.1.4 LED Indicator Details

The MP2300 performs a variety of diagnostics at startup. If an error is found, the ERR LED indicator blinks red. The number of times the indicators blink differs depending on the error details, so error details can be determined from counting the number of blinks. The following table shows details of MP2300 LED indicator.

- MPE720 cannot be operated when the indicators are blinking.
- For information on errors and countermeasures, refer to 6.3.3 LED Indicators.

Type	LED Indicator Name					Indicator Details	Remarks
	RDY (Green)	FUN (Green)	ALM (Red)	ERR (Red)	BAT		
Normal	Not lit	Not lit	Lit	Lit	Not lit	Hardware reset status	-
	Not lit	Not lit	Not lit	Not lit	Not lit	Initializing	
	Not lit	Lit	Not lit	Not lit	Not lit	Executing DWG.A	
	Lit	Not lit	Not lit	Not lit	Not lit	User program stopped (Offline stop mode)	User program stops when the DIP switch or MPE720 is used to execute the STOP operation.
	Lit	Lit	Not lit	Not lit	Not lit	User program executing normally (Online operation mode)	-
Error	Not lit	Not lit	Not lit	Lit	Not lit	Major damage has occurred	The ERR LED indicator is lit red when the CPU is down.
	Not lit	Not lit	Not lit	Blinking	Not lit	(Software error) No. of blinks 3: Address error (read) exception 4: Address error (write) exception 5: FPU exception 6: Illegal general command error 7: Illegal slot command error 8: General FPU inhibited error 9: Slot FPU inhibited error 10: TLB duplicated bit error 11: LTB mistake (read) 12: LTB mistake (write) 13: LTB protection violation (read) 14: LTB protection violation (write) 15: Initial page write error	The ERR LED indicator will blink red when an exception error has occurred.
	Not lit	Not lit	Blinking	Blinking	Not lit	(Hardware errors) No. of blinks 2: RAM diagnosis error 3: ROM diagnosis error 4: CPU function diagnosis error 5: FPU function diagnosis error	The ALM and ERR LED indicators will blink red if there is a self-diagnosis failure.
Alarm	-	-	-	-	Lit	Battery alarm	The BAT LED indicator will be lit when the battery voltage drops.
	Lit	Not lit	Lit	Not lit	Not lit	Operation error I/O error	The ALM LED indicator will be lit red when an operation or I/O error is detected.

5.2 User Programs

User programs for executing machine control using the MP2300 include ladder programs and motion programs. This section describes the basic operation and other information about user programs.

- ♦ For programming details, refer to the following manuals.
 - Machine Controller MP900/MP2000 Series User's Manual Ladder Programming* (SIEZ-C887-1.2)
 - Machine Controller MP900/MP2000 Series User's Manual Motion Programming* (SIEZ-C887-1.3)
 - Machine Controller MP900/MP2000 Series New Ladder Editor Programming Manual* (SIEZ-C887-13.1)
 - Machine Controller MP900/MP2000 Series New Ladder Editor User's Manual* (SIEZ-C887-13.2)

5.2.1 Ladder Drawings (DWG)

Ladder programs are managed in units of ladder drawings, which are identified by drawing numbers. These drawings form the basis of user programs.

(1) Types of Drawings

Ladder drawings include parent drawings, child drawings, grandchild drawings, and operation error processing drawings. In addition to drawings, there are functions that can be freely accessed from each drawing.

- **Parent Drawings**
Parent drawings are automatically executed by the system program when the execution conditions, outlined in the table below, are met.
- **Child Drawings**
Child drawings are accessed using a SEE command from a parent drawing.
- **Grandchild Drawings**
Grandchild drawings are accessed using a SEE command from a child drawing.
- **Operation Error Processing Drawings**
Operation error processing drawings are automatically executed by the system program when an operation error occurs.
- **Functions**
Functions are accessed and executed from parent, child, and grandchild drawings using the FSTART command.

(2) Drawing Types and Order of Priority

Drawings are classified by their first letter (A, I, H, or L) based on the processing purpose. The following table outlines the order of priority and execution conditions for these drawings.

Type of Parent Drawing	Function	Priority	Execution Conditions	Max. No. of Drawings
DWG.A (Drawing A)	Startup processing	1	Power ON (Executed once only, when power turned ON)	64
DWG.I (Drawing I)	Interrupt processing	2	External interrupt (executed by Option Module DI interrupt or counter match interrupt)	64
DWG.H (Drawing H)	High-speed scan processing	3	Scheduled cycle startup (Executed each high-speed scan)	200
DWG.L (Drawing L)	Low-speed scan	4	Scheduled cycle startup (Executed each low-speed scan)	500

The following table provides details of the number of drawings for each drawing.

Drawing	Number of Drawings			
	DWG.A	DWG.I	DWG.H	DWG.L
Parent Drawings	1 (A)	1 (I)	1 (H)	1 (L)
Operation Error Processing Drawings	1 (A00)	1 (I00)	1 (H00)	1 (L00)
Child Drawings	Total: 62 max.	Total: 62 max.	Total: 198 max.	Total: 498 max.
Grandchild Drawings				

5.2.2 Execution Control of Drawings

(1) Execution Control

The following table shows when each drawing is executed based on the order of priority.

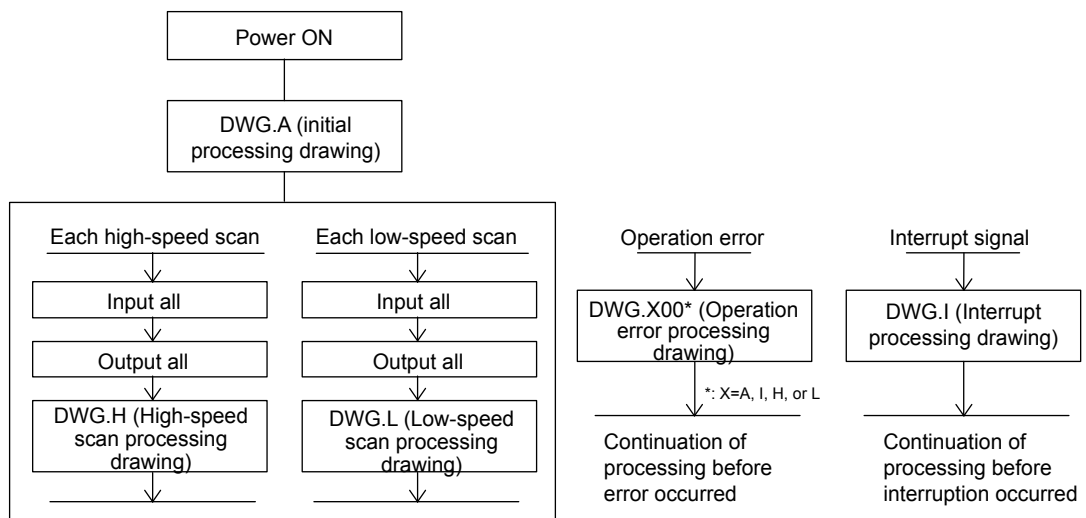

(2) Execution Schedule for Scan Processing Drawings

The scan processing drawings are not executed simultaneously. As shown in the following figure, the execution of each drawing is scheduled based on the order of priority and time sharing.

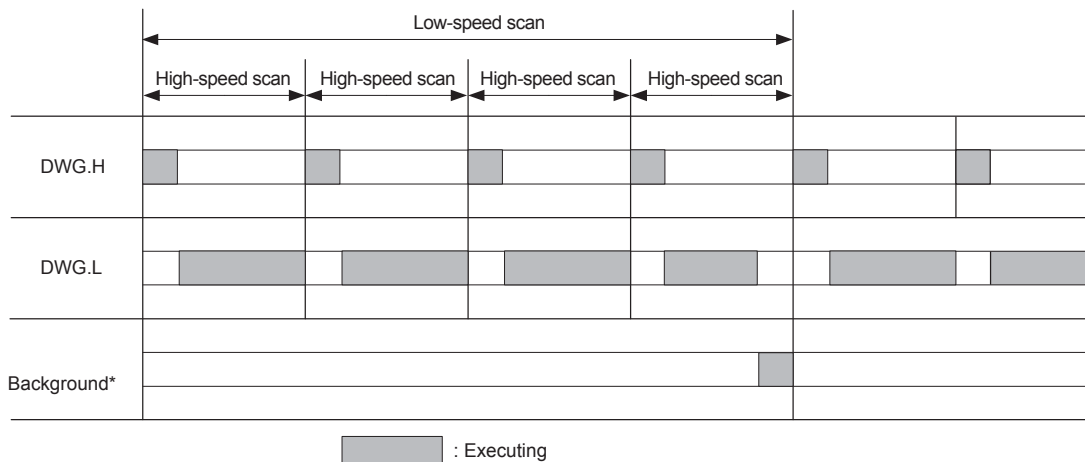

* Background processing is used to execute internal system processing, e.g., communication processing.

Low-speed scan processing is executed in spare processing time of the high-speed scan. Set the time of the high-speed scan to approximately double the total execution time for DWG.H.

(3) Hierarchical Structure of Drawings

Each processing program is made up of parent drawings, child drawings, and grandchild drawings. Parent drawings cannot call child drawings from a different type of drawing and child drawings cannot call grandchild drawings from a different type of drawing. Also, parent drawings cannot directly call grandchild drawings. Child drawings are always called from parent drawings and grandchild drawings are always called from child drawings. This is the hierarchical structure of drawings.

As shown in the following figure, each processing program is created from a hierarchy of parent, child, and grandchild drawings.

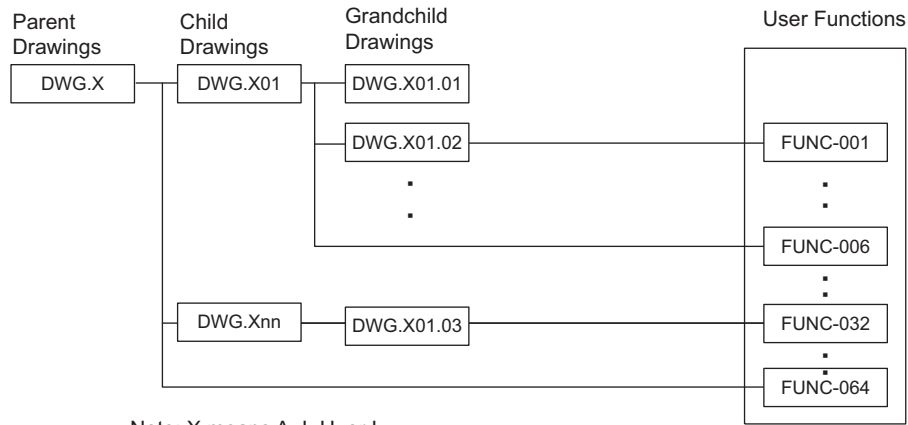

The type of drawing and the parent-child-grandchild relationship can be determined from the descriptors after “DWG.”

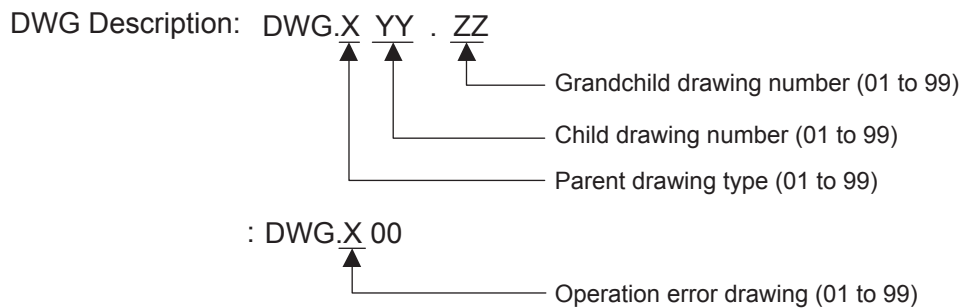

(4) Drawing Execution Processing Method

The execution processing of hierarchical drawings are performed by calling lower-level drawings from higher-level drawings.

The following figure shows the execution processing for drawings, using DWG.A as an example.

System programs are started according to execution conditions.

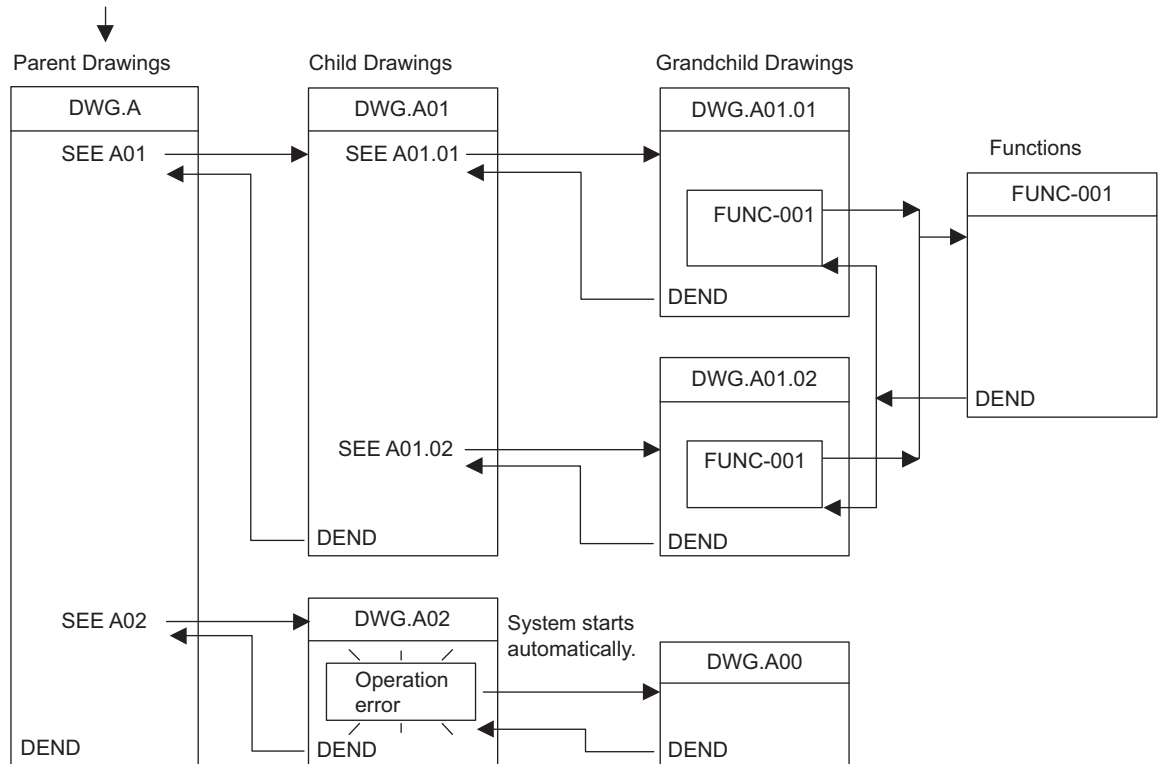

- Functions can be called from any drawing. Functions can also be called from other functions.
- When an operation error occurs, the operation error processing drawing for that drawing will be started.

5.2.3 Motion Programs

(1) Outline

Motion programs are programs written in a text-based language called motion language. Up to 256 motion programs can be created separate from ladder drawings.

The following table shows the two types of motion programs.

Type	Specification Method	Features	No. of Programs
Main Program	MPM□□□ (□□□ = 1 to 256)	Accessed from DWG.H	Up to 256 programs (including main and sub programs) can be created.
Subprogram	MPS□□□ (□□□ = 1 to 256)	Can be called from main programs	

- Specify a different MPM and MPS program number (□□□) between 1 and 256 for each program.
- The MP2300 can execute up to 16 motion programs simultaneously. An alarm (no system work error*) will occur if 17 or more programs are executed simultaneously.

* No system work error: Bit E of the leading word in the MSEE work registers

There are two methods for specifying motion programs: direct specification of the program number or indirect specification by specifying the register number where the program number is stored.

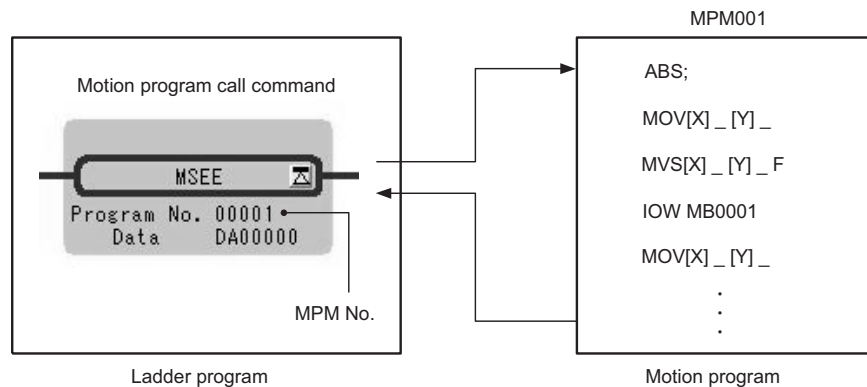

Fig. 5.1 Calling Motion Programs Using Direct Specification

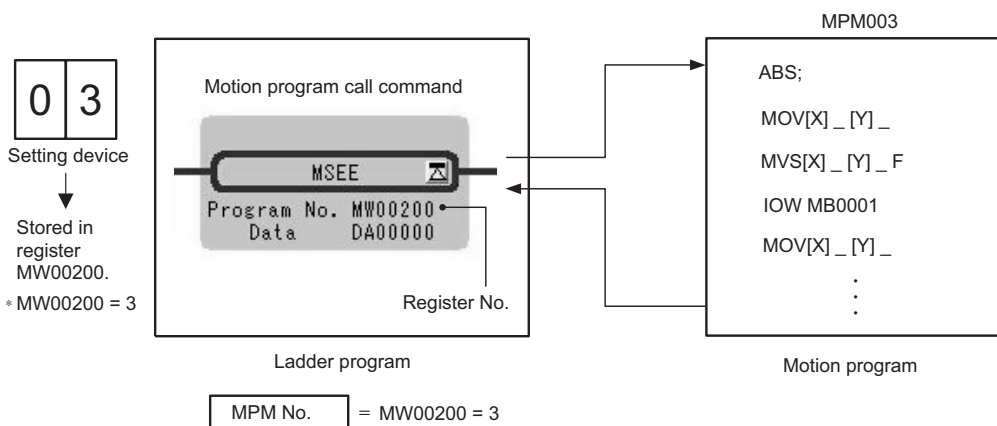

Fig. 5.2 Calling Motion Programs Using Indirect Specification

- For the meaning of register numbers and how to interpret them, refer to 5.3 Registers on page 5-21.

(2) Groups

A group of axes with related operations can be treated as one group by motion programs and programs can be executed for each group. This allows one MP2300 to independently control multiple machines using group operation. Group operation can be single group operation or multiple group operation.

Definitions for axes to be grouped together are made under *Group Definitions*. For details on group definitions, refer to *Machine Controller MP900/MP2000 Series User's Manual MPE720 Software for Programming Device* (SIEPC88070005).

(a) Single Group Operation

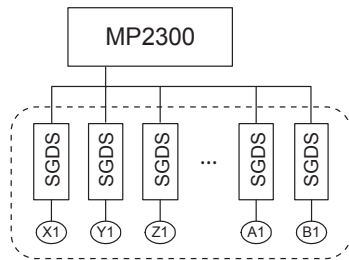

(b) Multiple Group Operation

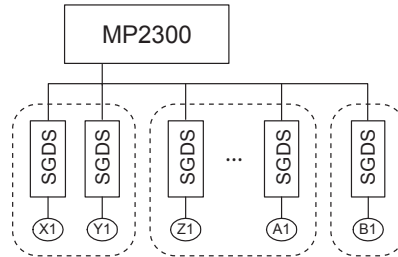

(3) Motion Program Execution Example

Motion programs are always called from H drawings using the MSEE command (motion program call command).

Motion programs can be called from any parent, child, or grandchild drawing in an H drawing.

The following figure shows an example of motion program execution.

System programs are started according to execution conditions.

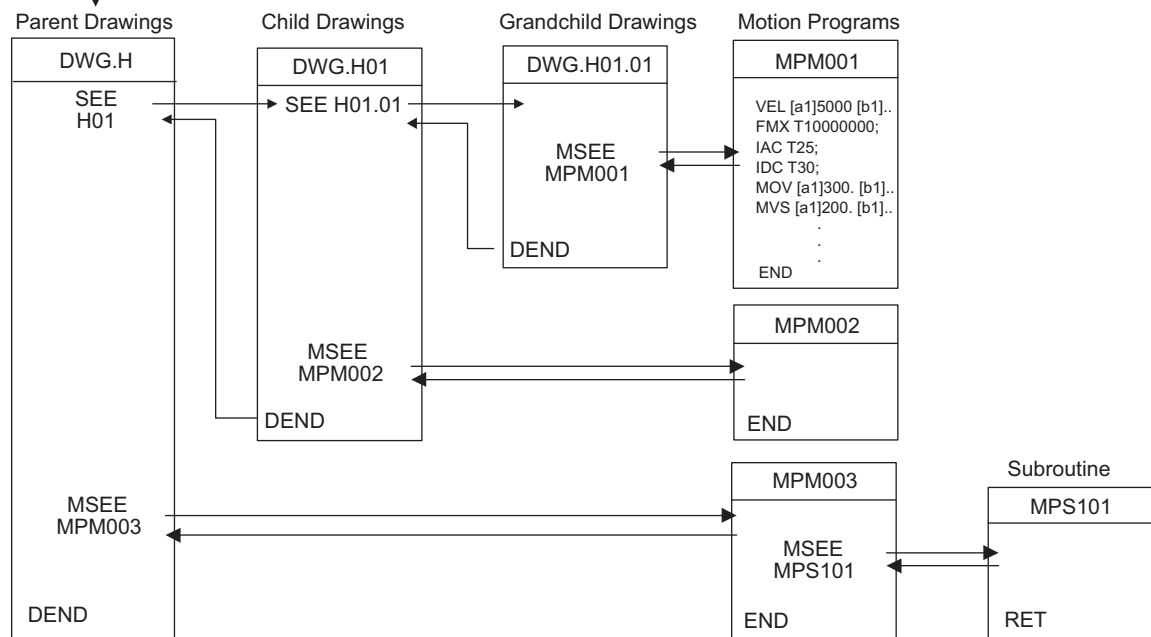

H drawing ladder commands are executed in hierarchical order i.e., parent drawings, child drawings, then grandchild drawings each high-speed scan cycle.

Motion programs are also called each scan cycle, but unlike ladder programs, all motion programs cannot be executed in one scan. For this reason, motion programs are executed and controlled by special system's motion management function.

- Ladder program MSEE commands cannot call motion program subroutines (MPS□□□). Subroutines can be called only from motion programs (MPM□□□ and MPS□□□).
- The same motion program or same subroutine can be called only once in one scan.

5.2.4 Motion Programs and MSEE and S Registers

Motion program status, control signal, interpolation override, and system work number data is saved in four MSEE registers (4 words) with DA□□□□□ (□: hexadecimal number) leading address. This data is called every time the MSEE command is executed in an H drawing. Motion program execution information can be monitored in the S registers.

The following figure shows the method for executing motion programs. MSEE register details and S register descriptions are also provided below from (1) onwards.

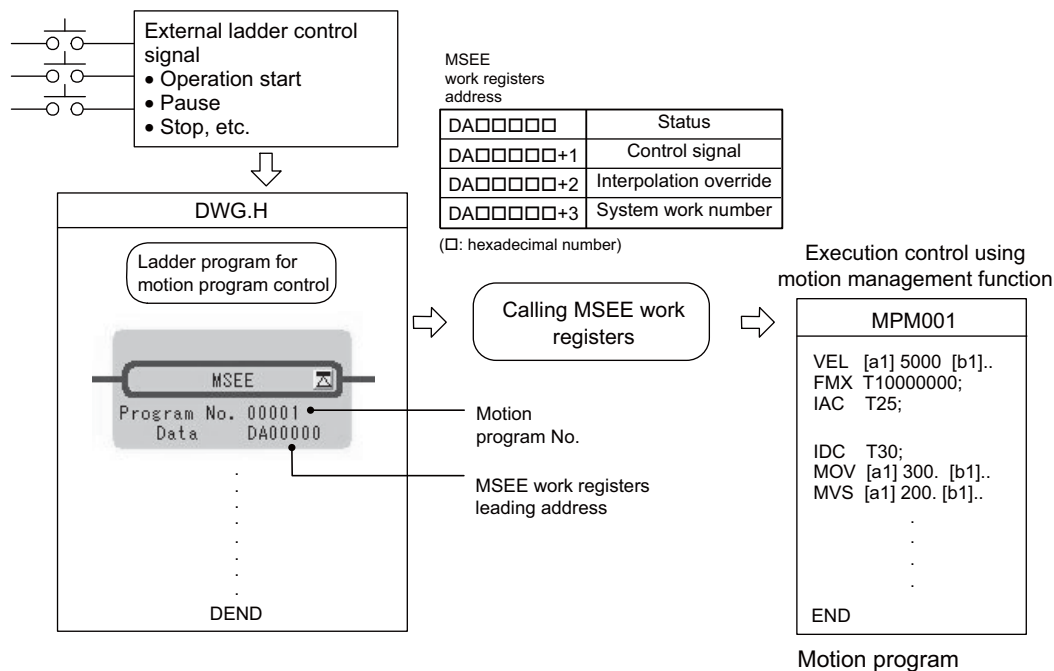

- For the meaning of register numbers and how to interpret them, refer to 5.3 Registers on page 5-21.

(1) Motion Program Status Bits (DA□□□□□+0)

The leading word (DA□□□□□+0) in the MSEE work registers contains the motion program status bits for monitoring execution status of the motion program.

The following table shows details of status bit.

Bit No.	Status
0	Program running
1	Program paused
2	Program stopped by stop request (used by system)
3	(Used by system)
4	Single program block operation stopped
8	Program alarm
9	Stopped by brake point
B	In debug mode (EWS debugging operation)
D	Start request signal history
E	No system work error
F	Main program number exceeded error

- Alarm details are saved in the S registers.

(2) Motion Program Control Signals (DA□□□□□+1)

Program control signals (e.g., program operation start requests and program stop requests) need to be entered to execute the motion program called from DWG.H using the MSEE command. The second word of the MSEE work registers (DA□□□□□+1) is the motion program control signal.

The following types of signals for controlling motion programs are available.

Bit No.	Signal Name	Signal Type
0	Program operation start request	Differential or NO contact input
1	Program pause request	NO contact
2	Program stop request	NO contact
3	Program single block mode selection	NO contact
4	Program single block start request	Differential or NO contact input
5	Alarm reset request	NO contact
6	Program continuous operation start request	Differential or NO contact input
8	Skip 1 information	NO contact
9	Skip 2 information	NO contact
D	System work number setting	NO contact OFF: The system will use the automatically obtained system work number. The system work number may be different each time. ON: The work with the set system work number will be used.
E	Interpolation override setting	NO contact OFF: Interpolation override 100% fixed ON: Conforms to set interpolation override

These signals can perform run, stop, hold, and other controls for motion programs by entering from the ladder program to the work register specified by the MSEE command +1.

Use signals conforming to the above signal types when writing ladder programs.

- Motion programs are executed if the program operation start request signal is ON when the power is turned ON (e.g., when a start request signal is left in M register).

■ Timing Chart for Motion Program Control Signals

The following figure shows an example of a timing chart for motion program control signals.

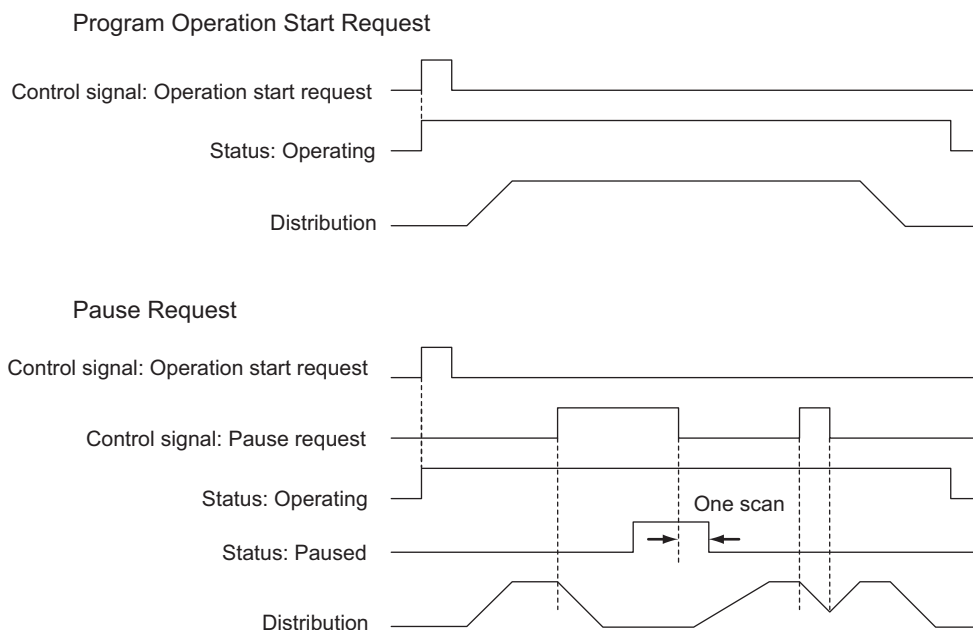

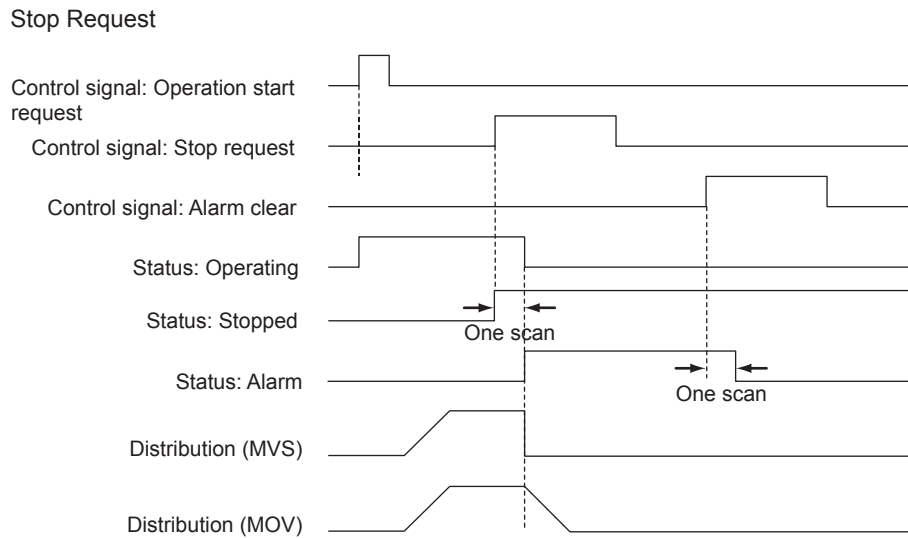

- An alarm will occur if the stop request is turned ON during axis operation using a motion command.

(3) Interpolation Override (DA□□□□□+2)

The override when executing interpolation travel commands (setting; unit: 1 = 0.01%) is set in the third word of the MSEE work registers (DA□□□□□+2).

This interpolation override is enabled only when the motion program control signal bit E (interpolation override setting) is ON.

(4) System Work Number (DA□□□□□+3)

The system work number n (setting range: 1 to 16) used when executing motion programs is set by the fourth word of the MSEE work registers (DA□□□□□+3).

This system work number is enabled only when the motion program control signal bit D (system work number setting) is ON. The status bit, bit E (No system work error), will turn ON if the work number setting is outside the setting range or the specified system work is in use.

(5) Monitoring Motion Program Execution Information Using S Registers

The S registers (SW03200 to SW04191) can be used to monitor motion program execution information.

■ Register Areas for Motion Program Execution Information

Motion program execution information		Executing program number	
SW03200	Executing program number (No. of main program currently executing) 16W	SW03200	Program number used by work 1
SW03216	Reserved by the system. 16W	SW03201	Program number used by work 2
SW03232	Executing Program Bit (Executing when corresponding bit is ON) 16W	SW03202	Program number used by work 3
SW03248	Reserved by the system. 16W	SW03203	Program number used by work 4
SW03264	Program information used by work 1 58W	SW03204	Program number used by work 5
SW03222	Program information used by work 2 58W	SW03205	Program number used by work 6
SW03380	Program information used by work 3 58W	SW03206	Program number used by work 7
SW03438	Program information used by work 4 58W	SW03207	Program number used by work 8
SW03496	Program information used by work 5 58W	SW03208	Program number used by work 9
SW03554	Program information used by work 6 58W	SW03209	Program number used by work 10
SW03612	Program information used by work 7 58W	SW03210	Program number used by work 11
SW03670	Program information used by work 8 58W	SW03211	Program number used by work 12
SW03728	Program information used by work 9 58W	SW03212	Program number used by work 13
SW03786	Program information used by work 10 58W	SW03213	Program number used by work 14
SW03844	Program information used by work 11 58W	SW03214	Program number used by work 15
SW03902	Program information used by work 12 58W	SW03215	Program number used by work 16
SW03960	Program information used by work 13 58W		
SW04018	Program information used by work 14 58W		
SW04076	Program information used by work 15 58W		
SW04134	Program information used by work 16 58W		
SW04192	Reserved by the system. 928W		
SW05120	Reserved by the system. 64W		

Executing program bit	
SW03232	MP□016 (Bit15) to MP□001 (Bit0)
SW03233	MP□032 (Bit15) to MP□017 (Bit0)
SW03234	MP□048 (Bit15) to MP□033 (Bit0)
SW03235	MP□054 (Bit15) to MP□049 (Bit0)
SW03236	MP□080 (Bit15) to MP□055 (Bit0)
SW03237	MP□096 (Bit15) to MP□081 (Bit0)
SW03238	MP□112 (Bit15) to MP□097 (Bit0)
SW03239	MP□128 (Bit15) to MP□113 (Bit0)
SW03240	MP□144 (Bit15) to MP□129 (Bit0)
SW03241	MP□160 (Bit15) to MP□145 (Bit0)
SW03242	MP□176 (Bit15) to MP□161 (Bit0)
SW03243	MP□192 (Bit15) to MP□177 (Bit0)
SW03244	MP□208 (Bit15) to MP□193 (Bit0)
SW03245	MP□224 (Bit15) to MP□209 (Bit0)
SW03246	MP□240 (Bit15) to MP□225 (Bit0)
SW03247	MP□256 (Bit15) to MP□241 (Bit0)

Note: □ indicates M or S.

■ Details of Program Information Used by Work n

Program information used by work n

+0	Program status	
+1	Program control signal	
+2	Parallel 0 information	3W
+5	Parallel 1 information	3W
+8	Parallel 2 information	3W
+11	Parallel 3 information	3W
+14	Parallel 4 information	3W
+17	Parallel 5 information	3W
+20	Parallel 6 information	3W
+23	Parallel 7 information	3W
+26	Logical axis #1 program current position	2W
+28	Logical axis #2 program current position	2W
+30	Logical axis #3 program current position	2W
+32	Logical axis #4 program current position	2W
+34	Logical axis #5 program current position	2W
+36	Logical axis #6 program current position	2W
+38	Logical axis #7 program current position	2W
+40	Logical axis #8 program current position	2W
+42	Logical axis #9 program current position	2W
+44	Logical axis #10 program current position	2W
+46	Logical axis #11 program current position	2W
+48	Logical axis #12 program current position	2W
+50	Logical axis #13 program current position	2W
+52	Logical axis #14 program current position	2W
+54	Logical axis #15 program current position	2W
+56	Logical axis #16 program current position	2W

Executing program number
Executing block number
Error code

The monitoring method differs depending on the setting for bit D of the motion program control signal (system work number setting).

[a] When Bit D of Motion Program Control Signal (System Work Number Setting) is ON

The execution information is reported to the “Program information used by work n” registers (SW03264 to SW04133). For example, when the system work number is 1, the motion program execution information can be monitored using SW03246 to SW03321 “Program information used by work 1.”

[b] When Bit D of Motion Program Control Signal (System Work Number Setting) is OFF

The system automatically determines the system work to be used. This means that the work being used can be checked under “Executing program number” (SW03200 to SW03215).

For example, if the motion program to be monitored is MPM001, and SW03202 is 001, the number of the work being used is 3. This means that the execution information for motion program MPM001 can be monitored using “Program information used by work 3” (SW03380 to SW03437).

5.2.5 Example of Ladder Programs for Motion Program Control

The following figure shows the minimum ladder programming required for controlling motion programs.

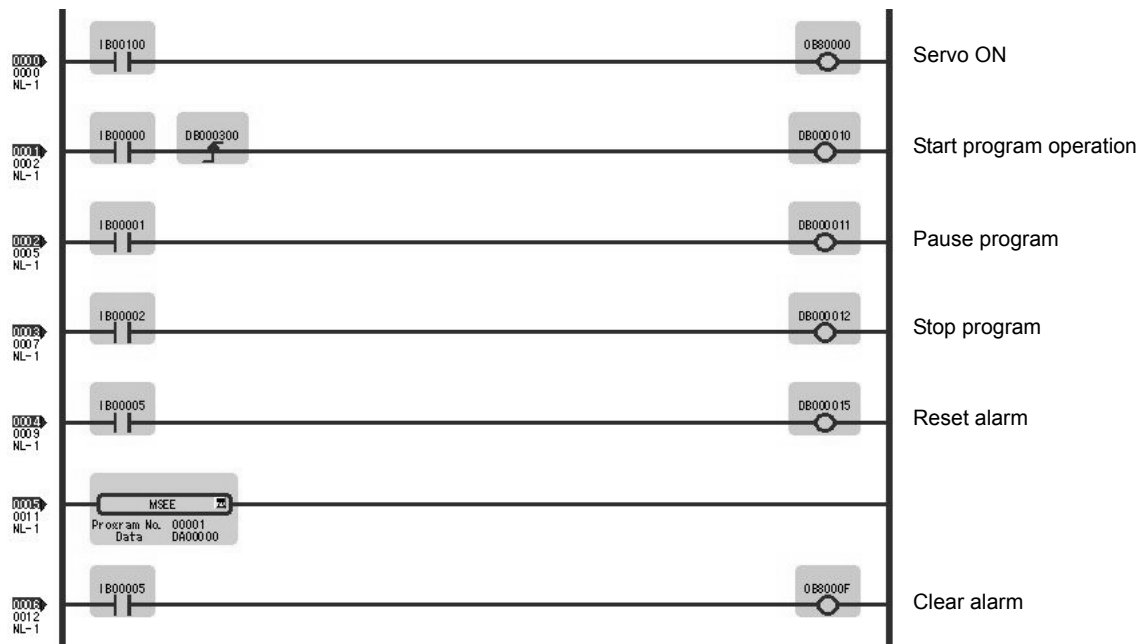

The following table shows the details of the above ladder program.

Step No.	Program Details
1	The servo ON signal (IB00100) sets the Servo ON motion settings parameter (OB80000) and turns ON the Servo.
2 to 10	The signals connected to the MP2300 external input signals are stored as the motion program control signals. IW0000 (external input signal) → DW00001 (Second word of MSEE work registers) <ul style="list-style-type: none"> • Start program operation • Pause program • Stop program • Reset alarm
11	Calls motion program MPM001 MSEE <u>MPM001</u> <u>DA00000</u> (1) (2) (1) Motion program number (2) Leading MSEE work register address
12	Sets motion settings parameter Alarm Clear (OB0000F) using the alarm reset signal (IB00005) and clears the alarm.

If the above ladder program is used to enter external input signals connected to the MP2300 (IB00000 to IB00005) to DW00001 (second word of MSEE work registers) as the motion program control signals, motion program operations such as run, pause, and stop can be performed using the system's motion management function.

The following tables show an example of the minimum external input signals required to create the above ladder program.

External Signal Address	External Signal Name
IB00000:	Start program operation
IB00001:	Pause program
IB00002:	Stop program
IB00005:	Reset the alarm.



Bit No.	Motion Program Control Signal
0:	Program operation start request
1:	Program pause request
2:	Program stop request
5:	Alarm reset request

5.2.6 Functions

Functions are executed by calling them from parent, child, or grandchild drawings using the FSTART command. Functions can be called from any drawing, and the same function can be called at the same time from different types of drawings and from different levels of drawings. Another completed functions can also be called from functions.

Using functions has the following advantages.

- Easier creation of user program components
- Easier writing and maintenance of user programs

Functions include standard system functions that are already in the system and user functions that are defined by the user.

(1) Standard System Functions

The transmission and other functions listed below are already created as standard system functions. Standard system functions cannot be changed by users.

Type	Name	Symbol	Contents
System functions	Counter	COUNTER	Incremental/decremental counter
	First in/first out	FINFOUT	First in/first out
	Trace function	TRACE	Data trace execution control
	Data trace read	DTRC-RD	Reads data from data trace memory to user memory
	Inverter trace read function	ITRC-RD	Reads trace data from inverter trace memory to user memory
	Message send	MSG-SND	Sends messages to external communication devices
	Message receive	MSG-RCV	Receives messages from external communication devices

(2) User Functions

The functions (programs) and the function definitions can be changed (programmed) freely by users.

The maximum number of user functions that can be defined is 500 drawings.

- Refer to the following manuals for information on defining functions.
 - Machine Controller MP900/MP2000 Series User's Manual Ladder Programming (SIEZ-C887-1.2)
 - Machine Controller MP900/MP2000 Series User's Manual Motion Programming (SIEZ-C887-1.3)
 - Machine Controller MP900/MP2000 Series New Ladder Editor Programming Manual (SIEZ-C887-13.1)
 - Machine Controller MP900/MP2000 Series New Ladder Editor User's Manual (SIEZ-C887-13.2)

5.3 Registers

This section describes the types of registers used in MP2300 user programs (mainly ladder programs) and how to use them.

5.3.1 Types of Registers

(1) DWG Registers

Registers used by ladder programs (ladder drawings; DWG). Each drawing can use the registers outlined in the following table.

Type	Name	Specification Method	Range	Details	Characteristics
S	System registers	SB, SW, SL, SFnnnnn (SAnnnnn)	SW00000 to SW08191	Registers provided by the system. SW00000 to SW00049 are cleared to all zeros when the system starts.	Common to all drawings
M	Data registers	MB, MW, ML, MFnnnnn (MAnnnnn)	MW00000 to MW65534	Registers shared by all drawings. Used, e.g., as an interface between drawings.	
I	Input registers	IB, IW, IL, IFhhhh (IAhhhh)	IW0000 to IW7FFF	Registers used for input data.	
O	Output registers	OB, OW, OL, OFhhhh (OAhhhh)	OW0000 to OW7FFF	Registers used for output data.	
C	Constants registers	CB, CW, CL, CFnnnnn (CAnnnnn)	CW00000 to CW16383	Registers that can only be called from programs.	
#	# registers	#B, #W, #L, #Fnnnnn (#Annnnn)	#W00000 to #W16383	Call-only registers Can be called only by corresponding drawing. The usage range is set by the user using MPE720.	Unique to each drawing
D *	D registers	DB, DW, DL, DFnnnnn (DAnnnnn)	DW00000 to DW16383	Internal registers unique to each drawing. Can be used only by corresponding drawing. The usage range is set by the user using MPE720.	

- n: Decimal number; h: Hexadecimal number
- B, W, L, F, and A: Data type (B: Bit, W: Integer, L: Double-length integer, F: Real number, A: Address. Refer to 5.3.2 *Data Types and Register Specifications* on page 5-24.)
- * Up to 32 D registers (32 words, DW0000 to DW0031) can be used when creating drawings, but this can be changed in the MPE720 Drawings Properties Window. Refer to the *Machine Controller MP900/MP2000 Series User's Manual MPE720 Software for Programming Device* (SIEPC88070005) for details.



- S and M register data has a battery backup to ensure the data is held even if the MP2300 power is turned OFF and ON. Other register data is saved to flash memory, so when the MP2300 power is turned OFF to ON, data saved to flash memory is read and data not saved to flash memory is lost. It is recommended, therefore, that data to be held regardless of whether or not the power is turned OFF to ON should be written to M registers if possible.

(2) Function Registers

The following table shows the registers that can be used with each function.

Type	Name	Specification Method	Range	Details	Characteristics
X	Function input registers	XB, XW, XL, XFnnnnn	XW00000 to XW00016	Input to functions Bit input: XB000000 to XB00000F Integer input: XW00001 to XW00016 Double-length integer input: XL00001 to XL00015	Unique to each function
Y	Function output registers	YB, YW, YL, YFnnnnn	YW00000 to YW00016	Output from functions Bit output: YB000000 to YB00000F Integer output: YW00001 to YW00016 Double-length integer output: YL00001 to YL00015	
Z	Internal function registers	ZB, ZW, ZL, ZFnnnnn	ZW0000 to ZW00063	Internal registers unique to each function Can be used for function internal processing.	
A	External function registers	AB, AW, AL, AFhhhh	AW0000 to AW32767	External registers with the address input value as the base address. For linking with S, M, I, O, #, and DAnnnnn.	
#	# registers	#B, #W, #L, #Fnnnnn (#Annnnn)	#W00000 to #W16383	Call-only registers Can be called only from the relevant function. The usage range is set by the user using MPE720.	
D	D registers	DB, DW, DL, DFnnnnn (DAnnnnn)	DW00000 to DW16383	Internal registers unique to each function. Can be called only the relevant function. The usage range is set by the user using MPE720.	
S	System registers	SB, SW, SL, SFnnnnn (SAnnnnn)	Same as DWG registers These registers are shared by drawings and functions. Pay attention to how these registers are to be used when calling the same function from a drawing of a different priority level.		
M	Data registers	MB, MW, ML, MFnnnnn (MAnnnnn)			
I	Input registers	IB, IW, IL, IFhhhh (IAhhhh)			
O	Output registers	OB, OW, OL, OFhhhh (OAhhhh)			
C	Constants registers	CB, CW, CL, CFhhhh (CAnnnn)			

- n: Decimal number; h: Hexadecimal number
- B, W, L, F, and A: Data type (B: Bit, W: Integer, L: Double-length integer, F: Real number, A: Address. Refer to 5.3.2 *Data Types and Register Specifications* on page 5-24.)
- SA, MA, IA, OA, DA, #A, and CA registers can be used within functions.

(3) Register Ranges in Programs

The following figure shows DWG programs, function programs, and register call ranges.

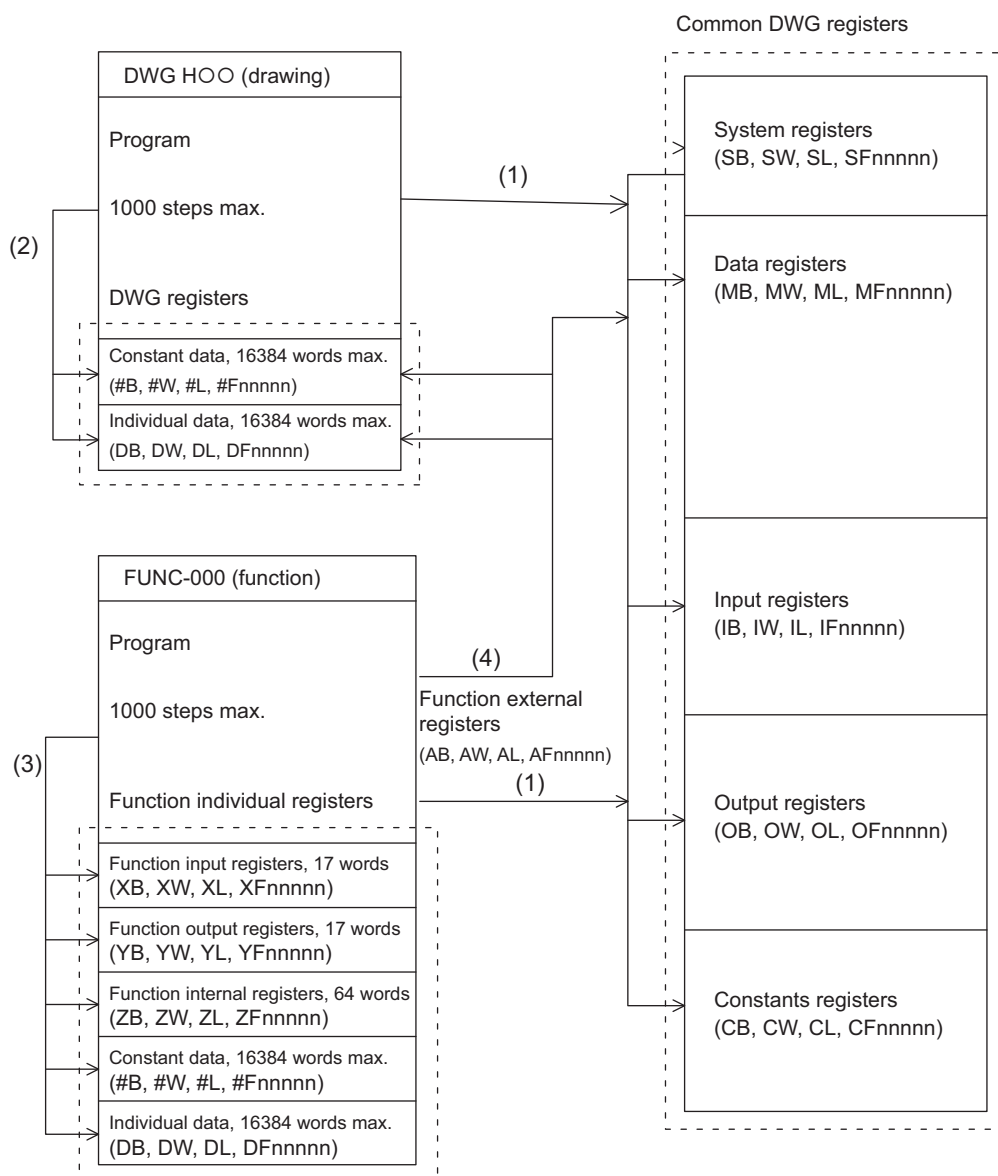

- (1): Registers that are common to all drawings can be called from any drawing or function.
 (2): Registers that are unique to each drawing can be called only from within the drawing.
 (3): Registers that are unique to each function can be called only from within the function.
 (4): Registers that are common to all drawings and registers that are unique to each drawing can be called from functions using the external function registers.

5.3.2 Data Types and Register Specifications

There are five kinds of data: Bit, integer, double-length integer, real number, and address data. Each is used differently depending on the application. Address data, however, is used only inside functions when specifying pointers. The following table shows the types of data.

Type	Data types	Numeric Value Range	Remarks
B	Bit	0, 1	Used by relay circuits.
W	Integer	-32768 to +32767 (8000H) (7FFFH)	Used for numeric value operations. The values in parentheses () indicate use with logical operations.
L	Double-length integer	-2147483648 to +2147483647 (80000000H) (7FFFFFFFH)	Used for numeric value operations. The values in parentheses () are for use with logical operations.
F	Real number	$\pm (1.175E-38 \text{ to } 3.402E+38), 0$	Used for numeric value operations.
A	Address	0 to 32767	Used only when specifying pointers.

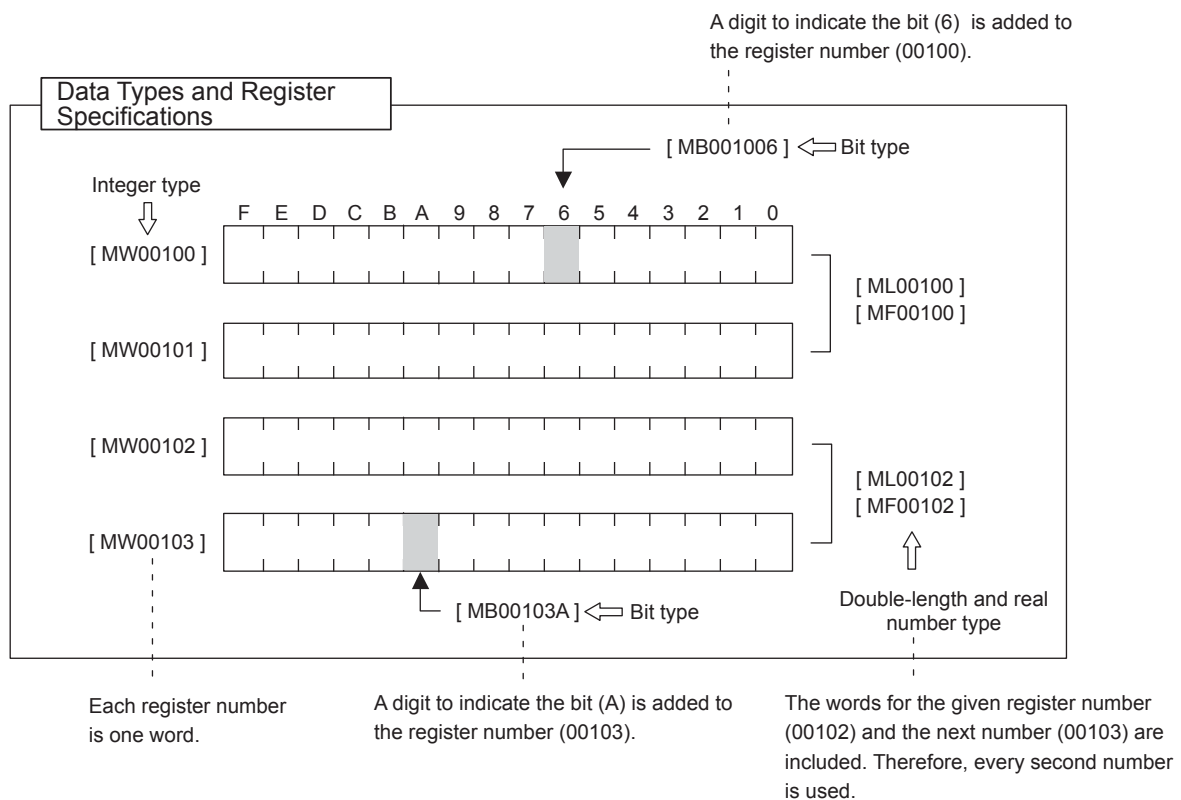

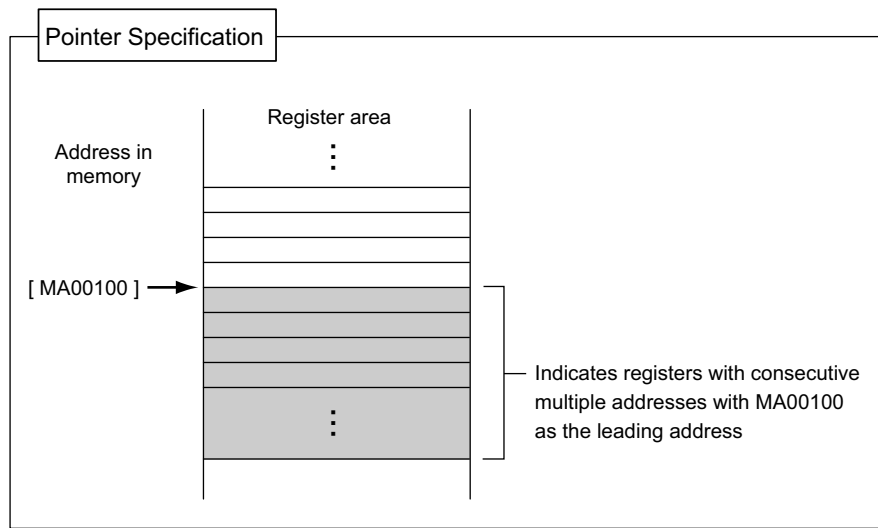

5.3.3 Using i and j Subscripts

There are two special register modifiers, i and j, that can be used with relay and register numbers. The functions of i and j are exactly the same. They are used for handling register numbers as variables.

Examples of each register data type are used to explain the use of i and j.

(1) Bit Registers with Subscripts

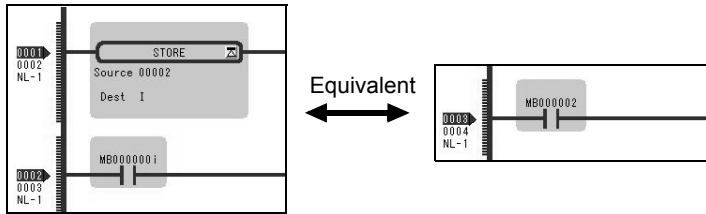

These are the same as when i or j values are added to relay numbers.

For example, when i = 2, MB00000i is the same as MB000002. And when j = 27, MB00000j is the same as MB00001B.

(2) Integer Registers with Subscripts

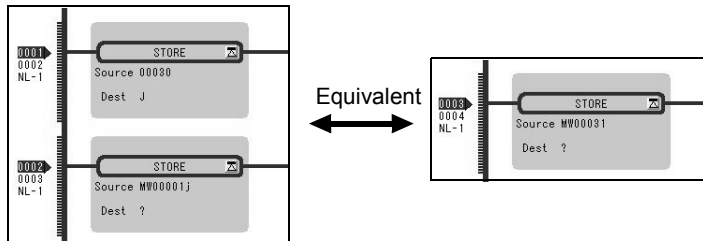

These are the same as when i or j values are added to register numbers.

For example, when i = 3, MW00010i is the same as MW00013. And when j = 30, MW00001j is the same as MW00031.

(3) Double-length Integers and Real Numbers with Subscripts

Double-length Integer Type	Upper word	Lower word
ML00000j when j = 0: ML00000	MW00001	MW00000
ML00000j when j = 1: ML00001	MW00002	MW00001
Real Number Type	Upper word	Lower word
MF00000j when j = 0: MF00000	MW00001	MW00000
MF00000j when j = 1: MF00001	MW00002	MW00001

These are the same as when i or j values are added to register numbers. For example, when j = 1, ML00000j is the same as ML00001. And when j = 1, MF00000j is the same as MF00001. For double-length integers and real numbers, the word that indicates a register is the lower word. Caution is required because this means that ML00001 and MF00001 will be different when j = 0 and when j = 1 because the upper and lower words will differ as shown in the following example.

Example Program Using Subscripts

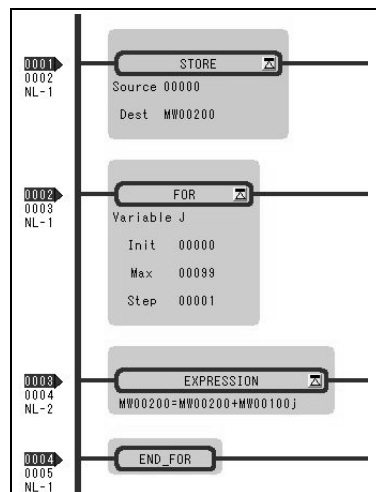

The program shown to the left finds the total of 100 registers from MW00100 to MW00199, using subscript j, and writes the total to MW00200.

5.3.4 Register Specification Methods

Registers can be specified directly by register number or by symbol (register name) specification. A combination of both of these register specification methods can be used in ladder programs.

When using the symbol specification method, the relationship between symbols and register numbers must be defined. The following table shows the register specification methods.

Specification Method	Specification Example by Data Type
Register number direct specification	Bit register: MB00100AX Integer register: MW00100X Double-length integer register: ML00100X Real number register: MF00100X Address register: MA00100X X: When specifying subscripts, subscript i or j is added after the register number.
Symbol specification	Bit register: RESET1-A.X Integer register: STIME-H.X Double-length integer registers: POS-REF.X Real number registers: IN-DEF.X Address registers: <u>PID-DATA.X</u> ↓ 8 alphanumeric characters max. X: When specifying subscripts, a period (.) is added after the symbol (8 alphanumeric characters max.) and then a subscript i or j is added.

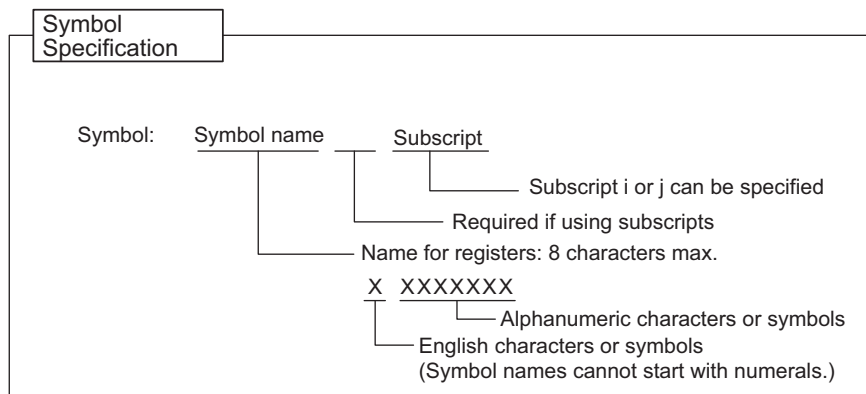
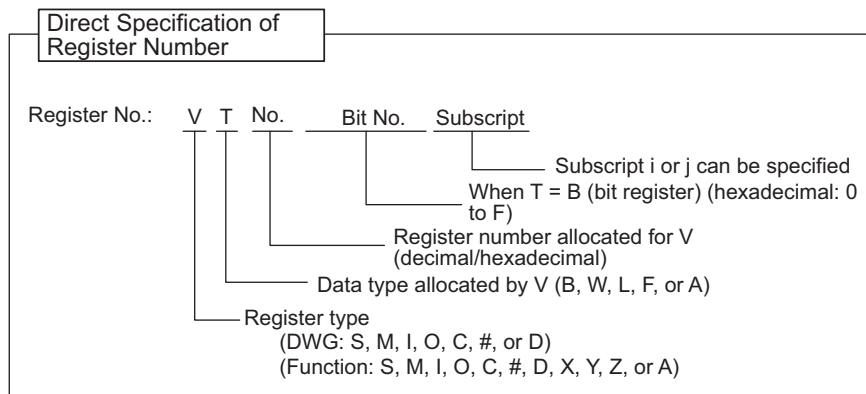

5.4 Self-configuration

When the self-configuration function is implemented, the Machine Controller recognizes the mounted optional modules, and automatically creates the Module Configuration Definition, Module Details Definition files of each optional module. The self-configuration function greatly reduces the system startup time. The following figure shows how the self-configuration function works.

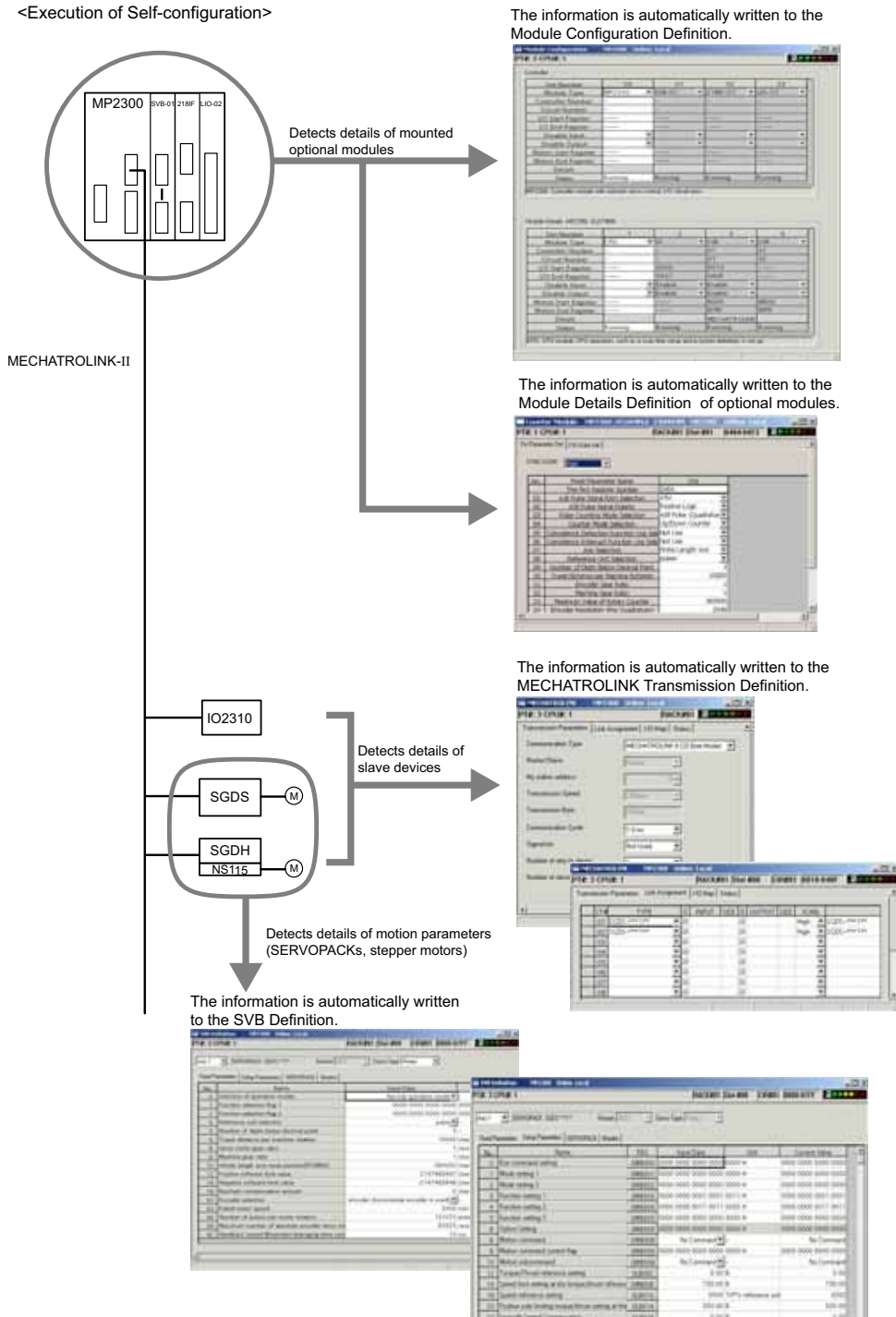

Self-configuration can be executed by switch of Basic Modules, or by MPE720.

- Refer to 5.4.2 Execution Procedure for Self-configuration Using the DIP Switch and 5.4.3 Execution Procedure for Self-configuration Using MPE720 for the procedure to execute the self-configuration.

5.4.1 Self-configuration Processing Procedure

Self-configuration collects MECHATROLINK transmission definition data and slave data using the following procedure.

In the MP2300, the communication method is determined when the slave is detected, after which communication method switching and slave detection are not performed. When not even a single slave station is detected, MECHATROLINK-I communication continues.

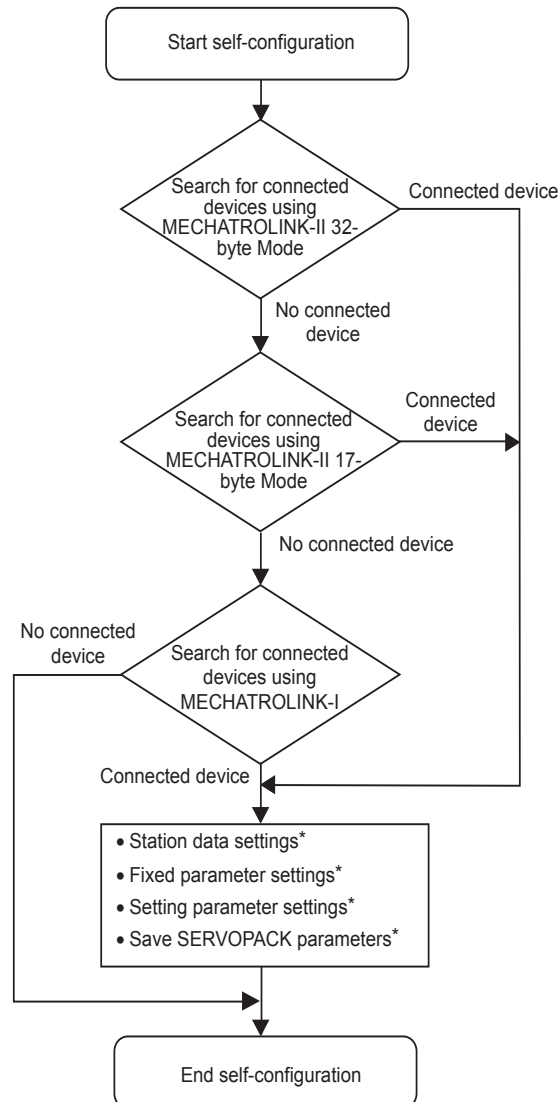

- ♦ Slaves detection is performed for each communication in the following order: SERVOPACK, I/O, inverter.
- ♦ No connection is detected for stations with disconnected cables, for which a communication error has occurred, from which no response is received, or with the same station number as another station.
- * Refer to 4.5 System Startup Using Self-Configuration and 4.1.5 MP2300 Self-configuration for information on station data settings, fixed parameters settings, setting parameter settings, and saving SERVOPACK parameters.

5.4.2 Execution Procedure for Self-configuration Using the DIP Switch

Self-configuration can be executed from the Basic Module DIP switch.

(1) Executing Self-configuration for the First Time after Connecting Devices

Turn ON the power to the MP2300 and then use the procedure described below. With this operation, self-configuration will be executed for all modules and all new definition files will be created. In addition, ladder drawings, functions, and all registers will be cleared.

In the following procedure, it is assumed that the power supply to all Σ-III SERVOPACKs are already turned ON.

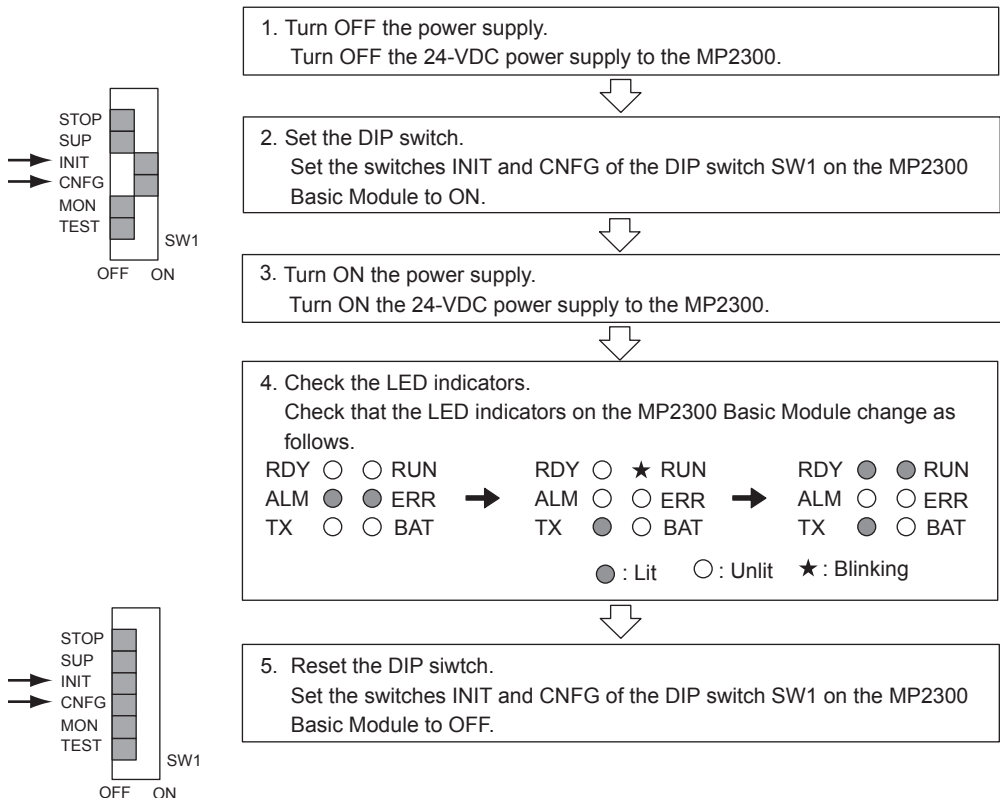

(2) Self-configuration after Adding Devices Such as SERVOPACKs

For self-configurations after having added network devices such as SERVOPACKs, leave the switch INIT to OFF in step (2) of the above procedure, then perform the rest of the steps.

- For network devices with existing definitions files, correctly connect and turn ON the power to the devices when executing self-configuration.



- If register allocations have been changed manually since the last time self-configuration was executed, the register allocations will return to the default settings when self-configuration is executed again. If the SVR is set to disabled (UNDEFINED), the setting will return to enabled. To keep the changed register allocations, do not use self-configuration, but manually make the register allocations for added devices and refresh the definitions file.
-

■ Power Restart and RAM data Clear

If the INIT switch on the DIP switch on the Basic Module is ON and the power is turned ON, RAM data will be cleared. Also, flash memory data will be read and RAM data will be overwritten when the INIT switch is OFF and the power is turned ON. In either case, the RAM data will be cleared by turning the power ON. Therefore, always save data to the MP2300 flash memory before turning OFF the power when writing or editing programs.

For information on how to save data to flash memory, refer to 4.2.3 (1) *Saving to Flash Memory* on page 4-21 (MPE720 Ver 6.□□) or 4.3.2 (6) *Saving to Flash Memory* on page 4-40 (MPE720 Ver 5.□□).

■ Turning OFF Power After Executing Self-configuration

Do not turn OFF the 24-VDC power supply to the MP2300 after executing self-configuration until the definitions data has been saved to flash memory in the MP2300. If the power is turned OFF somehow before the data is saved to flash memory, execute self-configuration again.

5.4.3 Execution Procedure for Self-configuration Using MPE720

Executing self-configuration from the MPE20 allows not only self-configuration for all the Modules but also self-configuration for individual Modules.

(1) Self-configuration for All the Modules

Select **Self Configure All Modules** when executing the self-configuration for the first time after connecting devices.

- After having added or deleted Modules or devices, use the procedure described in (2) Self-configuration of Each Module to detect the configuration. Executing **Self Configure All Modules** will overwrite the parameters that have been set.

1. Start the Engineering Manager of MPE720.

■ MPE720 Ver 6.□□

Start MPE720, and then open the target project file. Select **Setup - Module configuration** from the Launcher. Or, double-click **Module configuration** in the System sub programs.

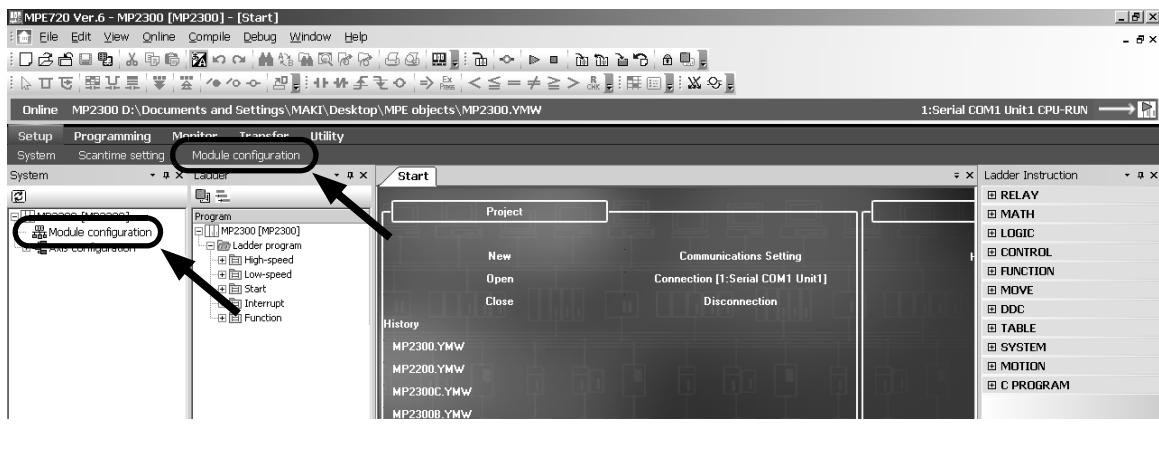

The **Engineering Manager** Window will open and the **Module Configuration** Window will appear.

■ MPE720 Ver 5.□□

In the **File Manager** Window, double-click the **Controller** folder and double-click the **Definition** folder. Five definition files will appear under the **Definition** folder. Double-click **Module Configuration**.

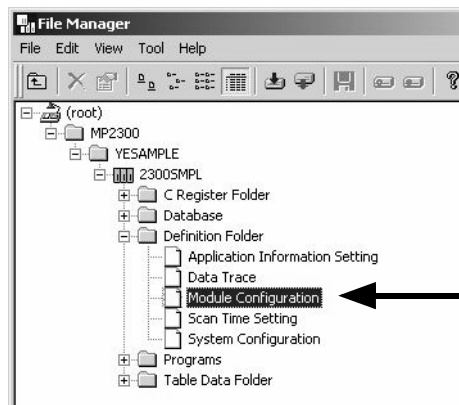

The **Engineering Manager** Window will open and the **Module Configuration** Window will appear.

2. Select **Order - Self Configure All Modules** from the main menu to execute self-configuration.

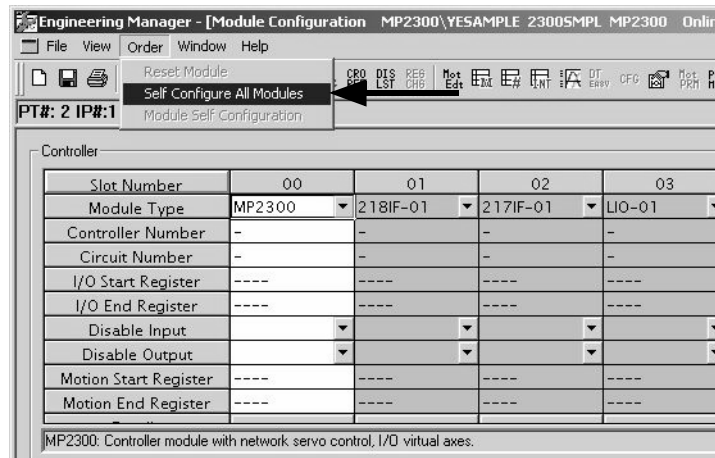

The RUN LED indicator will blink and a message indicating that *the module configuration definitions are being created* will be displayed. Once self-configuration has been completed, the message will disappear and the RUN LED indicator will return to its original state.

3. Select **File - Save & Save to FLASH** to save the definitions data to the flash memory.
4. Right-click the **No. 3** column in the Module Details area and click **MECHATROLINK** on the pop-menu that appears.

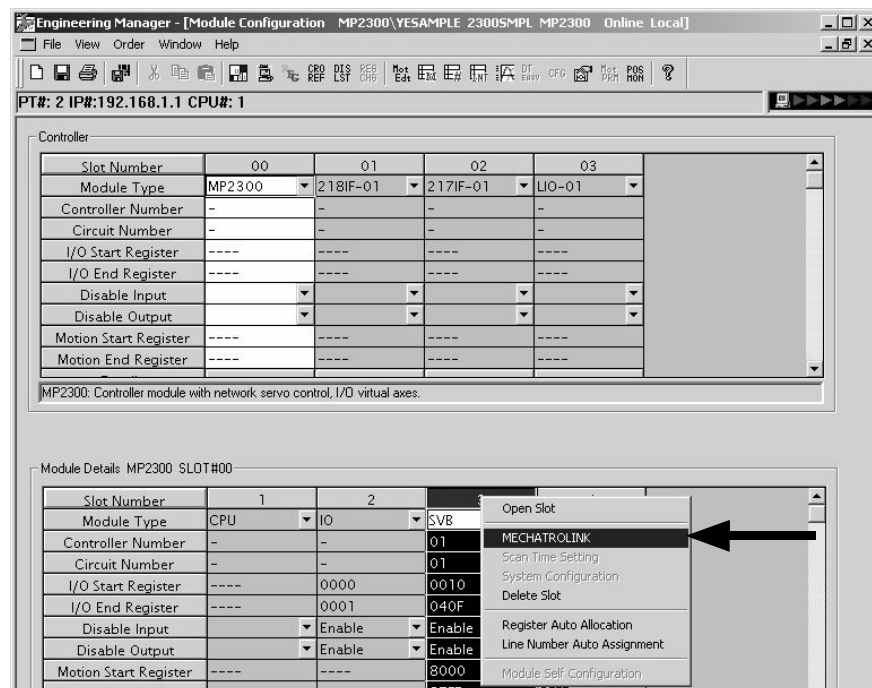

The **MECHATROLINK** Window will appear.

5. Select the Link Assignment Tab Page to display the devices currently connected to the Motion Board (SERVOPACK SGDS on this window) and the station numbers for those devices.

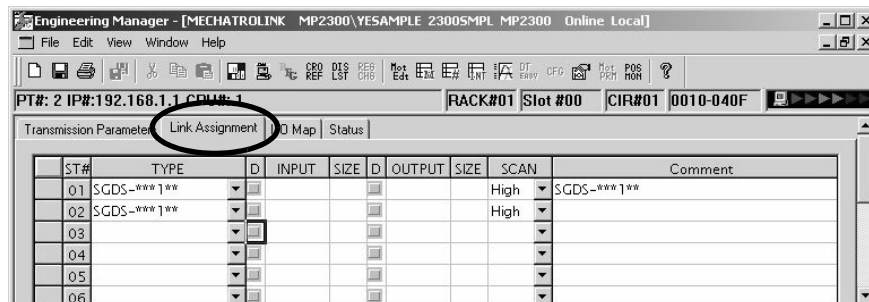

After confirming the devices, click to close the **MECHATROLINK** Window.

(2) Self Configuration of Each Module

If devices are added, self-configuration can be executed separately for the Module (port) that has been changed.

1. Start the Engineering Manager of MPE720.

■ MPE720 Ver 6.□□

Start MPE720, and then open the target project file. Select **Setup - Module configuration** from the Launcher. Or, double-click **Module configuration** in the System sub programs.

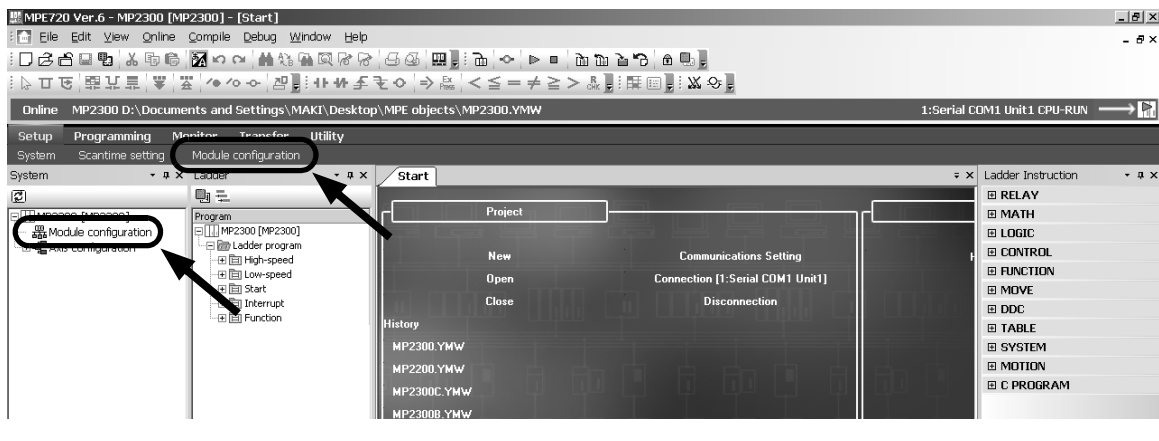

The **Engineering Manager** Window will open and the **Module Configuration** Window will appear.

■ MPE720 Ver 5.□□

Double-click the **Controller** folder and the **Definition** folder in the **File Manager** Window to display five definition files under the **Definition** folder. Double-click **Module Configuration**.

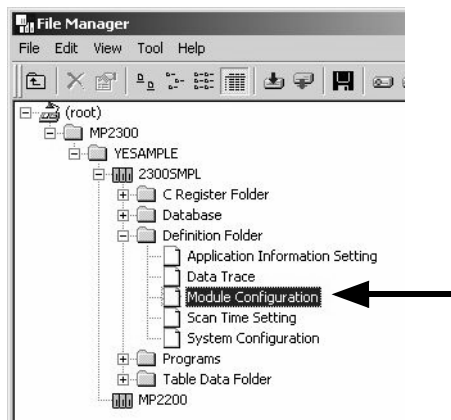

The **Engineering Manager** Window will start and the **Module Configuration** Window will appear.

2. Right-click the Module for which devices have been added and select **Module Self Configuration** from the pop menu to execute self-configuration.

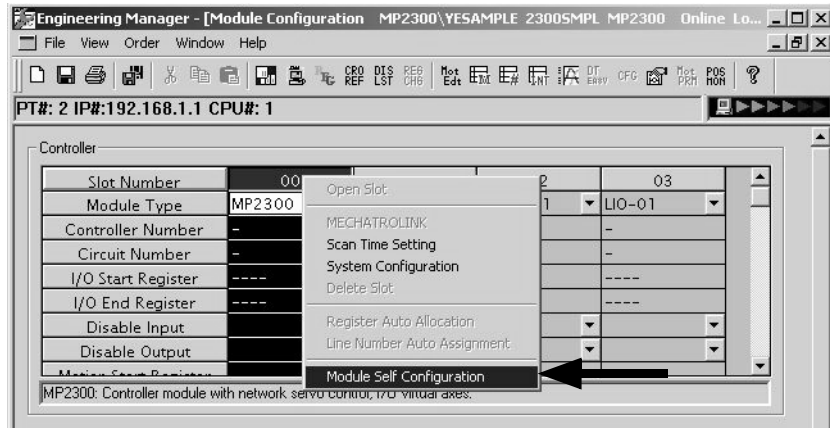

The RUN LED indicator will blink and a message indicating that *the module configuration definitions are being created* will be displayed. Once self-configuration has been completed, the message will disappear and the RUN LED indicator will return to its original state.

- When MP2300 is selected as an individual module, executing **Module Self Configuration** will configure all the modules.
3. Select **File - Save & Save to Flash** from the main menu. A confirmation message will appear. Click the **Yes** Button to save the module configuration definitions.

5.4.4 Definition Data Refreshed by Self-configuration

The MP2300 Basic Module definition data refreshed when self-configuration is executed are shown below.

(1) I/O Allocations

Item	Allocation
Digital input (DI 18 points)	IW0000
Digital output (DO 4 points)	OW0001
MECHATROLINK	Leading I/O registers: IW0010/OW0010 Ending I/O registers: IW040F/OW040F (Input registers: IW0010 to IW040F Output registers: OW0010 to OW040F)

(2) MECHATROLINK Transmission Definition Data

The following table shows the MECHATROLINK transmission definitions that are automatically set based on the detected communication method and number of slaves.

Communication type	MECHATROLINK-II (32-byte)		MECHATROLINK-II (17-byte)		MECHATROLINK-I
	1 ms*	2 ms*	14	15	
Transmission speed	10 Mbps		10 Mbps		4 Mbps
Transmission bytes (transfer bytes)	32		17		17
Communication cycle	1 ms*	2 ms*	1 ms		2 ms
Maximum number of slave stations	*	*	14	15	14
Number of retry stations	*	*	1	0	—
SigmaWin	Not supported		Not supported		—

- ♦ The communication cycle and number of retry stations in MECHATROLINK-II 32-byte Mode change according to the highest station number of the detected slaves as shown in the following table.

Highest Slave Station Number	Communication Cycle (ms)	Number of Retry Station
1 to 8	1	1
9	1	0
10 to 16	2	5
17 to 21	2	Determined by the following equation. 21 - (Highest station number)

■ Slave Devices Not Recognized by Self-configuration

The following slave devices (I/O modules) are recognized as wildcard I/O (***** I/O) because they do not have a model code. Make allocations again for these devices in the Module Configuration Window of the MPE720.

- JEPMC-IO350
- JAMSC-120DAI53330
- JAMSC-120DAI73330
- JAMSC-120DAO83330
- JAMSC-120DRA83030

Servos with special specifications and that cannot be automatically recognized are recognized as wildcard Servos (*****SERVO). Make allocations again for these Servos in the Module Configuration Window of the MPE720.

(3) Motion Parameters

When self-configuration is executed, the motion parameters are set from SERVOPACK data. Some of the parameters are written to the SERVOPACK's RAM.

For details of this data, refer to *11.6.5 Parameters Updated during Self-configuration* in the *Machine Controller MP2000 Series Built-in SVB/SVB-01 Motion Module User's Manual* (Manual No.:SIEPC80070033).

(4) SERVOPACK Parameters

When self-configuration is executed, SERVOPACK parameters are written to the SERVOPACK's EEPROM or RAM. These settings, however, are not written to the set values for the SERVOPACK parameters saved in the MP2300 and SVB-01 Module.

For details of the data that is written, refer to *11.6.5 Parameters Updated during Self-configuration* in the *Machine Controller MP2000 Series Built-in SVB/SVB-01 Motion Module User's Manual* (Manual No.:SIEPC80070033).

- To save the SERVOPACK parameters to the MP2300 Basic Module, MPE720 must be used. For details, refer to *4.3.2 (5) Making Servo Adjustments and Saving SERVOPACK Parameters* on page 4-38.

5.5 Precautions When Using the MP2300

This section describes precautions for setting or changing user definition files and for setting the scan times.

5.5.1 Precautions when Setting or Changing User Definition Files

User definition files (system settings, scan time settings, and module configuration definitions) must be saved to flash memory (**Save & Save to Flash**).

Use the MPE720 to set or change these user definition files. Be sure to save the results to flash memory. If data is not saved to flash memory, the settings and changes will be lost when the power supply to the MP2300 is turned OFF and ON.

<When Using MPE720 Ver 6.□□>

System Setting (Select **File - Environment Setting - Setup - System Setting** from the menu bar.)

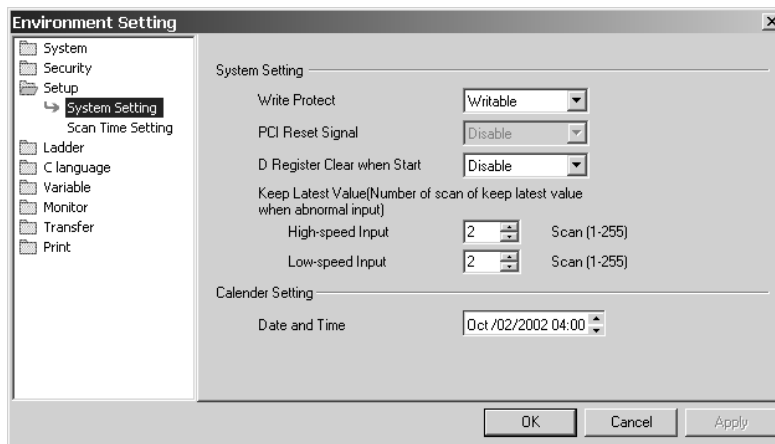

Scan Time Setting (Select **File - Environment Setting - Setup - Scan Time Setting** from the menu bar.)

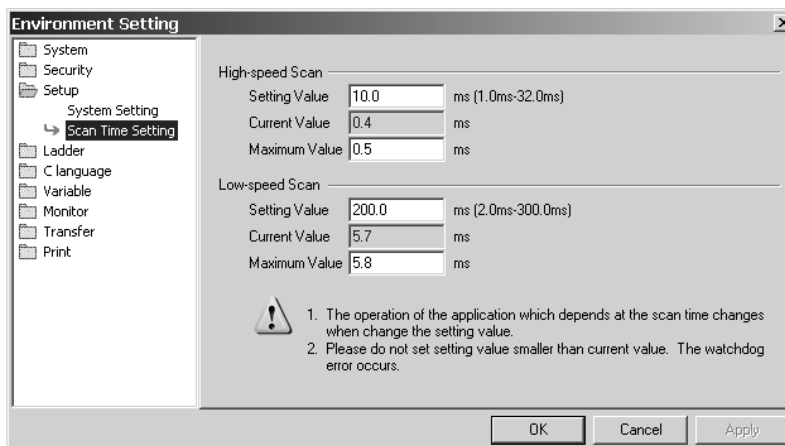

<When Using MPE720 Ver 5.□□>

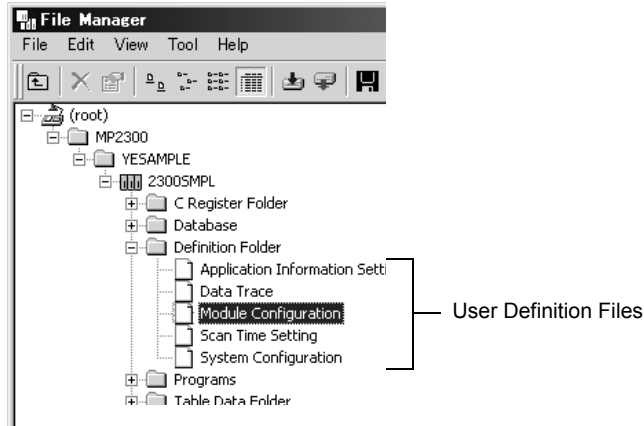

5.5.2 Precautions when Setting or Changing Module Configuration Definition Files

Observe the following precautions when setting or changing module configuration definition files.

- Always check to make sure that the mounted Module is the one that is defined.
- Be sure to save any new settings or changes to flash memory.
- After the settings or changes have been completed, turn the power supply to the MP2300 OFF and ON.

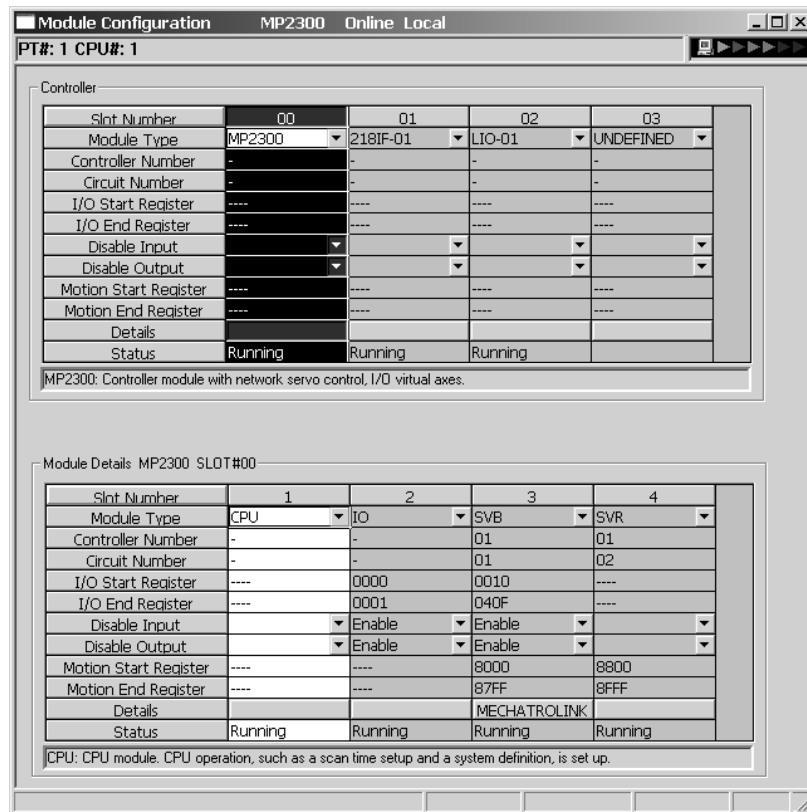

Fig. 5.3 Module Configuration Definition Window

5.5.3 Setting and Changing the Scan Time

(1) Precautions When Setting or Changing the Scan Time

Scan time can be set or changed in the following window.

<When Using MPE720 Ver 6.□□>

Scan Time Setting (Select **File - Environment Setting - Setup - Scan Time Setting** from the menu bar.)

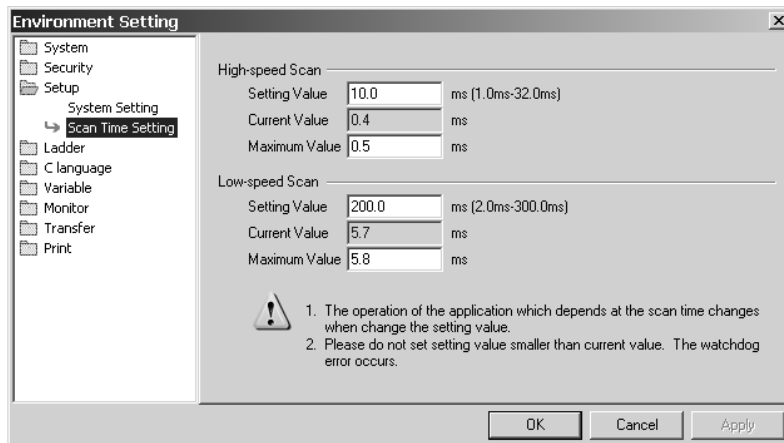

<When Using MPE720 Ver 5.□□>

Scan Time Setting (Double-click **Scan Time Setting** in the Definition Folder in the **File Manager** Window.)

Scan Time MP2300*YESAMPLE 2300SMPL	
PT#: 1 CPU#: 1	
Network Number	NT#000
Station Number	ST#00
Controller Number	CP#01
Controller Type	MP2100/2300
High Speed Scan Setting [ms]	10.0
H-Scan Maximum Value [ms]	0.6
H-Scan Current Value [ms]	0.4
H-Scan Steps [Steps]	41
Low Speed Scan Setting [ms]	200.0
L-Scan Maximum Value [ms]	0.2
L-Scan Current Value [ms]	0.1
L-Scan Steps [Steps]	0
Start-up Drawing Steps [Steps]	0
Interrupt Drawing Steps [Steps]	0
User Function Steps [Steps]	0
Total Number of Steps [Steps]	41
Total Program Memory [Bytes]	5767168

Observe the following precautions when setting or changing the scan time.

- Set the set values of the scan time for both the high-speed (H) and low-speed (L) scans to at least the maximum time required to execute the scans. We recommend setting the set values of the scan time using the formula (set value – maximum time to execute scan) $\geq (0.2 \times \text{set values of the scan time})$, i.e., setting the set values of the scan time to at least 1.25 times the maximum times required to execute the scans.
 - If the scan time is set too close to the maximum execution time for the scan, the refresh time for the screen on the MPE720 will be very slow and communication timeouts may occur. If the maximum execution time exceeds the scan time set value, a watchdog timer timeout error will occur and the MP2300 system will stop.
- Set the set values of the high-speed (H) and low-speed (L) scan time to an integral multiple of the MECHATROLINK communication cycle (1 or 2 ms) set in the MP2300. Always check the set values of the scan time after changing the MECHATROLINK communication cycle.
- Do not change the scan time set value while the Servo is ON. Never change the setting while the axis is moving (while the motor is running). Otherwise an error may occur during motor operation (e.g., high-speed rotation).
- When the scan time is set or changed, be sure to save the data to flash memory.

(2) Scan Time Set Value Examples

■ 0.8-ms Maximum Scan Time and 1-ms Communication Cycle (MECHATROLINK-II Only)

High-speed (or low-speed) scan set value $\geq 1.25 \times 0.8 (= 1 \text{ ms})$

High-speed (or low-speed) scan set value = 1 ms, 2 ms, 3 ms, etc. (an integral multiple of at least 1 ms)

■ 1.4-ms Maximum Scan Time and 1-ms Communication Cycle (MECHATROLINK-II Only)

High-speed (or low-speed) scan set value $\geq 1.25 \times 1.4 (= 1.75 \text{ ms})$

High-speed (or low-speed) scan set value = 2 ms, 3 ms, etc. (an integral multiple of at least 2 ms)

■ 0.8-ms Maximum Scan Time and 2-ms Communication Cycle (MECHATROLINK-I or MECHATROLINK-II)

High-speed (or low-speed) scan set value $\geq 1.25 \times 0.8 (= 1 \text{ ms})$

High-speed (or low-speed) scan set value = 1 ms, 2 ms, 4 ms, etc. (an integral multiple of 2 ms at 1 ms and 2 ms or higher)

■ 1.4-ms Maximum Scan Time and 2-ms Communication Cycle (MECHATROLINK-I or MECHATROLINK-II)

High-speed (or low-speed) scan set value $\geq 1.25 \times 1.4 (= 1.75 \text{ ms})$

High-speed (or low-speed) scan set value = 2 ms, 4 ms, etc. (an integral multiple of 2 ms at 2 ms or higher)

Maintenance and Inspection

This chapter explains daily and regular inspection items to ensure that the MP2300 can always be used at its best conditions.

6.1 Inspection Items	6-2
6.1.1 Daily Inspections	6-2
6.1.2 Regular Inspections	6-3
6.2 Replacing the Basic Module Battery	6-4
6.2.1 Procedure	6-4
6.3 Troubleshooting	6-5
6.3.1 Basic Flow of Troubleshooting	6-5
6.3.2 MP2300 Error Check Flowchart	6-6
6.3.3 LED Indicators	6-7
6.4 Troubleshooting System Errors	6-9
6.4.1 Outline of System Registers	6-9
6.4.2 Accessing System Registers	6-10
6.4.3 Troubleshooting When ERR is Lit	6-12
6.4.4 Troubleshooting When ALM is Lit	6-13
6.4.5 System Register Configuration and Error Status	6-14
6.5 Motion Program Alarms	6-24
6.5.1 Motion Program Alarm Configuration	6-24
6.5.2 Motion Program Alarm Code List	6-24
6.6 List of Causes for Command Error Occurrence	6-26
6.7 Troubleshooting Motion Errors	6-30
6.7.1 Overview of Motion Errors	6-30
6.7.2 Motion Error Details and Corrections	6-31
6.7.3 Servo Driver Status and Servo Driver Error Codes	6-36

6.1 Inspection Items

This section summarizes daily and regular inspection items that must be performed by the customer.

6.1.1 Daily Inspections

The following table lists the daily inspection items.

No.	Inspection Item	Inspection Details	Criteria	Action	
1	Installation conditions of Module, etc.	Check the mounting screws for looseness. Check whether the covers are all in place.	The screws and covers must be secured correctly.	Retighten the screws.	
2	Connection conditions	Check the terminal screws for looseness.	The screws must be tight.	Retighten the screws.	
		Check the connectors for looseness.	The connectors must be tight.	Retighten the connector set screws.	
		Check the gap between crimp terminals.	There must be an appropriate gap between the terminals.	Correct as necessary.	
3	LED Indicators	RDY	Check whether the indicator is lit.	The indicator must be lit. (It is abnormal if the indicator is not lit.)	Refer to 6.3.3 LED Indicators on page 6-7.
		RUN	Check whether the indicator is lit while the system is in RUN state.	The indicator must be lit. (It is abnormal if the indicator is not lit.)	
		ERR	Check whether the indicator is not lit.	The indicator must be not lit. (It is abnormal if the indicator is lit.)	
		ALM	Check whether the indicator is not lit.	The indicator must be not lit. (It is abnormal if the indicator is lit.)	
		TX	Check whether the indicator lights during communication.	The indicator must be lit. (It is abnormal if the indicator is not lit.)	
		BAT	Check whether the indicator is not lit.	The indicator must be not lit. (The battery voltage is too low if the indicator is lit.)	Replace the battery.

6.1.2 Regular Inspections

This section explains inspection items that must be performed once or twice every six months to one year.

Inspections must also be performed when the equipment is relocated or modified or when the wiring is changed.

 PROHIBITED
<ul style="list-style-type: none"> Do not replace the built-in fuse. <p>If the customer replaces the built-in fuse, the MP2300 may malfunction or break down. Contact your Yaskawa representative.</p>

Inspection Item		Inspection Details	Criteria	Action
Operating environment	Ambient temperature	Check the temperature and humidity with a thermometer and hygrometer, respectively. Check for corrosive gases.	0°C to 55°C	If the MP2300 is used inside a panel, treat the temperature inside the panel as the ambient temperature.
	Ambient humidity		30% to 95%	
	Atmosphere		There must be no corrosive gases.	
Power supply voltage check	PS Module	Measure the voltage between 24-VDC terminals.	19.2 to 28.8 VDC	Change the power supply as necessary.
Installation conditions	Looseness and excess play	Attempt to move the Module.	The Module must be secured properly.	Retighten the screws.
	Dust and other foreign matter	Visually check.	The Module must be free from dust and other foreign matter.	Clean.
Connection conditions	Check the terminal screws for looseness.	Check by retightening the screws.	The screws must be tight.	Retighten.
	Gap between crimp terminals	Visually check.	There must be an appropriate gap between the terminals	Correct.
	Looseness of connectors	Visually check.	The screws must be tight.	Retighten the connector set screws.
Battery		Check the BAT indicator on the front panel of the Basic Module.	The BAT indicator must be not lit.	If the BAT indicator is lit, replace the battery.

6.2 Replacing the Basic Module Battery

The Basic Module has one replaceable built-in battery. This battery is used to back up data to prevent the data stored in the memory from being lost when power is interrupted (e.g., when the power supply to the Basic Module is turned OFF).

The built-in battery can retain the contents of the memory until the total time of power interruptions reaches one year. The warranty period of the battery is five years from the date of purchase. These values, however, differ according to the operating conditions, including the ambient temperature.

If the BAT indicator on the Basic Module lights, replace the battery with a replacement battery (JZSP-BA01) within two weeks. Any delay in battery replacement will result in the data stored in the memory being lost.

The appearance of the battery is illustrated below.

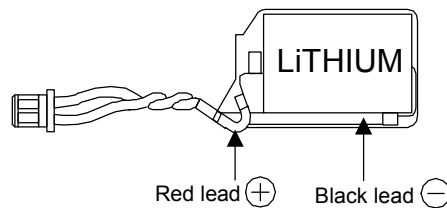

Fig. 6.1 JZSP-BA01 (Battery with Cable)

- This battery is not commercially available. Contact your Yaskawa representative.

6.2.1 Procedure

⚠ CAUTION

- There is danger of electric shock if the battery is not replaced correctly. Furthermore, machine malfunction may occur, the operator may be injured, or the machine may be damaged. Allow only a qualified technician trained in safety procedures to replace the battery.
- When replacing the battery, always do so with power supplied to the Basic Module. If power to the Basic Module is turned OFF when the battery is replaced, data stored in the memory in the Module may be lost.
- Do not touch the battery electrodes. The battery may be destroyed by the static electricity.

1. Save the data stored in the Motion Board to your computer using the MPE720.
 - MPE720 Ver 5.□□: Right-click the **Controller** Folder, and select *Transfer-All Files-From Controller to MPE720*.
 - MPE720 Ver 6.□□: Open the **Project** File, and select *Online - Transfer - Read from Controller*.

This data is used to restore any data accidentally lost during battery replacement.
2. Check that the RDY indicator on the MP2300 Basic Module is lit.
3. Open the battery cover on the unit front surface.
4. Remove the connector on the end of lead of the built-in battery from the connector on the MP2300 Basic Module. Then, remove the built-in battery from the battery holder.
5. Insert securely the connector on the end of the lead of the replacement battery into the connector on the MP2300. Then, insert the replacement battery into the battery holder.
6. Check if the BAT indicator on the MP2300 is unlit.
7. Close the battery cover. This completes replacing the battery.

6.3 Troubleshooting

This section describes the basic troubleshooting methods and provides a list of errors.

6.3.1 Basic Flow of Troubleshooting

When problems occur, it is important to quickly find the cause of the problems and get the system running again as soon as possible. The basic flow of troubleshooting is illustrated below.

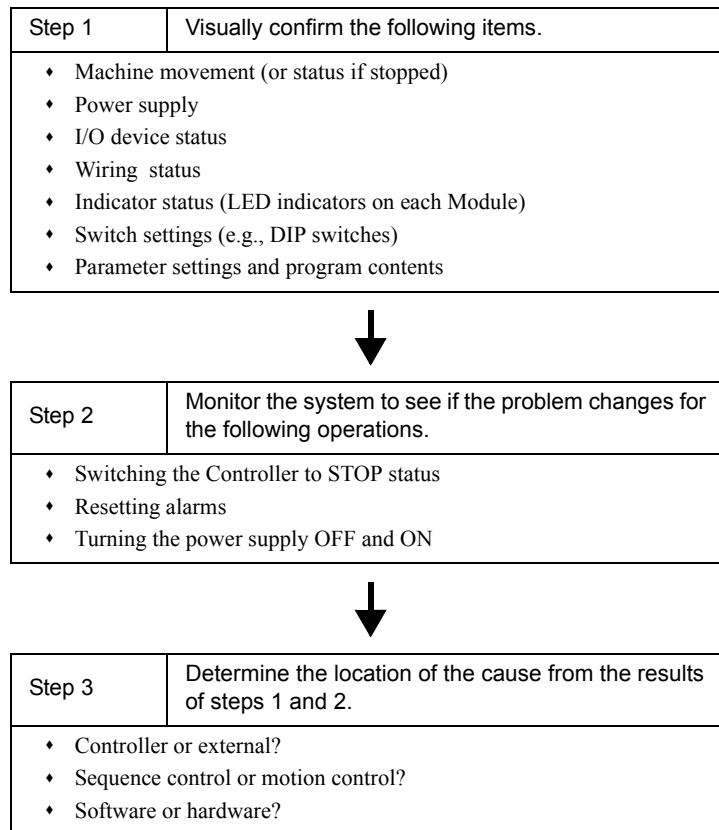

6.3.2 MP2300 Error Check Flowchart

Find the correction to the problem using the following flowchart if the cause of the problem is thought to be the MP2300 or SERVOPACK.

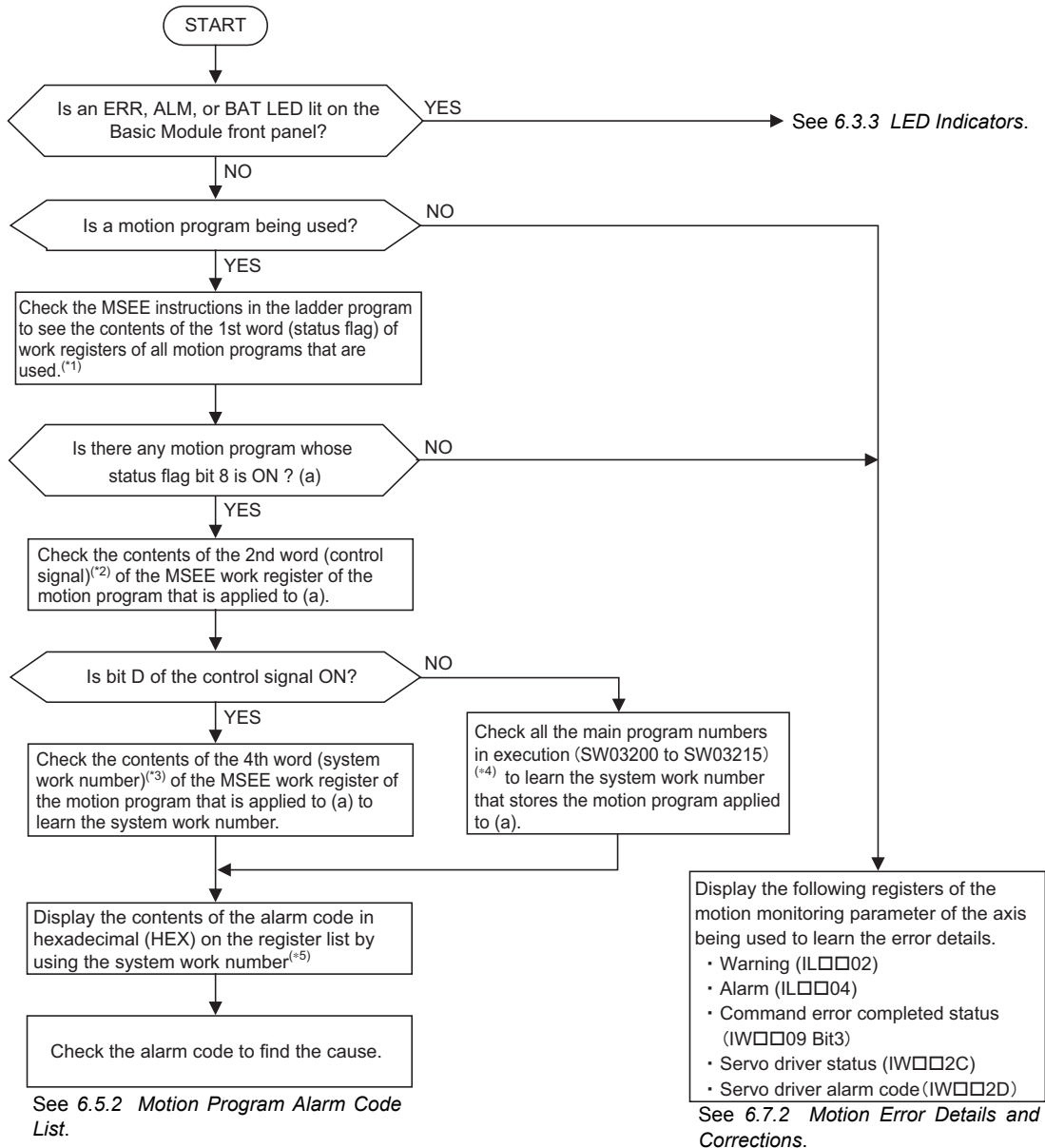

- * 1. Under each MSEE instruction in ladder programs, the motion program number that is used and the MSEE work leading register number are displayed.

When bit 8 (status flag: See 5.2.4 (1) *Motion Program Status Bits (DA□□□□□□+0)*) of the 1st word of the MSEE work leading register is ON, a motion program alarm is occurring. (For information on how to read the register list, refer to 6.4.2 *Accessing System Registers*.)

<Example> In the figures below, when the MSEE instruction shown on the left is executed in a ladder program, DW00000 is the MSEE work leading register number. Therefore, if bit 8 of DW00000 is ON, it means that a motion program alarm is occurring.

When the motion program number is indicated by a register number as shown on the right, check the corresponding register to learn the motion program number.



- * 2. For details on control signals, refer to 5.2.4 (2) *Motion Program Control Signals (DA□□□□□□+1)*.

- * 3. For details on system work number, refer to 5.2.4 (4) *System Work Number (DA□□□□□□+3)*.

- * 4. For information on the relationship between the registers from SW03200 to SW03215 and system work numbers, refer to 6.4.5 (9) *Motion Program Execution Information*.
- * 5. An alarm code of a motion program can be obtained from the program information used by work (58 words). Get the system work number first and then the alarm codes, referring to 6.4.5 (9) *Motion Program Execution Information*. The alarm code is written in each set of parallel information. If no parallel execution instruction such as PFORK, JOINTO, and PJOINT is used, the alarm code is stored in the parallel 0 information.

6.3.3 LED Indicators

(1) LED Indicators

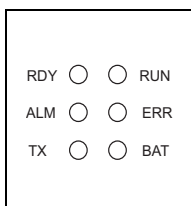

The status of the LED indicators on the front of the MP2300 Basic Module can be used to determine the error status and meaning.

The locations in the program that need to be corrected can be determined by using the LED indicator status to determine the general nature of the error, using the contents of system (S) registers to check drawings and function numbers causing the error, and knowing the meaning of operation errors.

(2) LED Indicator Meanings

The following table shows how to use the LED indicators to determine the operating status of the MP2300, as well as relevant error information when the LED indicator status indicates an error.

Classification	LED Indicator					Indicator Details	Countermeasures
	RDY	RUN	ALM	ERR	BAT		
Normal operation	Not lit	Not lit	Lit	Lit	Not lit	Hardware reset status	Usually the CPU will start within 10 seconds. If this status continues for more than 10 seconds, either a program error or hardware failure has occurred. Refer to 6.4 <i>Troubleshooting System Errors</i> on page 6-9 and correct any system errors.
	Not lit	Not lit	Not lit	Not lit	Not lit	Initialization	
	Not lit	Lit	Not lit	Not lit	Not lit	Drawing A (DWG.A) being executed.	
	Lit	Not lit	Not lit	Not lit	Not lit	User program stopped. (Offline Stop Mode)	
	Lit	Lit	Not lit	Not lit	Not lit	User program being executed normally.	

(cont'd)

Classification	LED Indicator					Indicator Details	Countermeasures
	RDY	RUN	ALM	ERR	BAT		
Errors	Not lit	Not lit	Not lit	Lit	Not lit	A serious error has occurred.	Refer to <i>6.4.3 Troubleshooting When ERR is Lit</i> on page 6-12.
	No lit	Not lit	Lit	Not lit	Not lit	A serious error has occurred.	Refer to <i>6.4.4 Troubleshooting When ALM is Lit</i> on page 6-13.
	Not lit	Not lit	Not lit	Blinking	Not lit	Software Error Number of LED blinks indicates error type. 3: Address error (read) exception 4: Address error (write) exception 5: FPU exception 6: Illegal general command exception 7: Illegal slot command exception 8: General FPU inhibited exception 9: Slot FPU inhibited exception 10: TLB multibit exception 11: LTB error (read) exception 12: LTB error (write) exception 13: LTB protection violation (read) exception 14: LTB protection violation (write) exception 15: Initial page write exception	A hardware error has occurred. Replace the Module.
	Not lit	Not lit	Blinking	Blinking	Not lit	Hardware Error Number of LED blinks indicates error type. 2: RAM diagnostic error 3: ROM diagnostic error 4: CPU function diagnostic error 5: FPU function diagnostic error	
Warnings	–	–	–	–	Lit	Battery alarm	Replace the memory storage battery.
	Lit	Lit	Lit	Not lit	Not lit	Operation error I/O error	Refer to <i>6.4.4 Troubleshooting When ALM is Lit</i> on page 6-13.

6.4 Troubleshooting System Errors

This section provides troubleshooting information for system errors.

6.4.1 Outline of System Registers

The LED indicators on the front of the Basic Module can be used to determine MP2300 operating status and error status. To obtain more detailed information on errors, the system (S) registers can be used. A detailed check of the contents of system registers can be used to determine the location of the error and take the corrective measures. The following table shows the overall structure of the system registers. Refer to the sections given on the right for details.

SW00000	System Service Register	
SW00030	System Status	→ 6.4.5 (1) <i>System Status</i> on page 6-14
SW00050	System Error Status	→ 6.4.5 (2) <i>System Error Status</i> on page 6-15
SW00080	User Operation Error Status	→ 6.4.5 (3) <i>Ladder Program User Operation Error Status</i> on page 6-16
SW00090	System Service Execution Status	→ 6.4.5 (4) <i>System Service Execution Status</i> on page 6-19
SW00110	User Operation Error Status Details	→ 6.4.5 (3) <i>Ladder Program User Operation Error Status</i> on page 6-16
SW00190	Alarm Counter and Alarm Clear	→ 6.4.5 (5) <i>Alarm Counter and Alarm Clear</i> on page 6-19
SW00200	System I/O Error Status	→ 6.4.5 (6) <i>System I/O Error Status</i> on page 6-19
SW00500	Reserved by the system.	
SW00698	Interrupt Status	
SW00800	Module Information	→ 6.4.5 (8) <i>MP2300 Module Information</i> on page 6-22
SW01312	Reserved by the system.	
SW02048	Reserved by the system.	
SW03200	Motion Program Information	→ 6.5 <i>Motion Program Alarms</i> on page 6-24
SW05200 to SW08191	Reserved by the system.	

6.4.2 Accessing System Registers

To access the contents of system registers, start the MPE720 Programming Tool and use the Register List or Quick Reference function.

The method to display a register list differs depending on the MPE720 version number, Ver 6.□□ or Ver 5.□□. The method for each version is described below.

(1) Displaying a Register List (MPE720 Ver 6.□□)

Use the following procedure to display a register list.

1. Open the **Register List** Sub-window from the **MPE720 Ver 6.□□** Main Window.

The **Register List 1** Tab is provided by default in the sub-window displayed on the bottom of the screen.

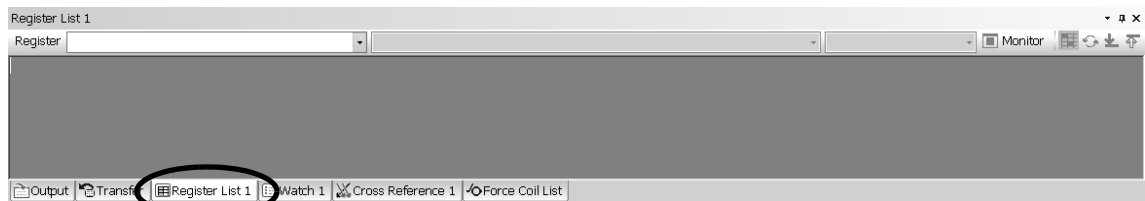

2. Enter the leading register number of the system register "SW□□□□□" to be accessed in the **Register** input field. The contents of the system register will be displayed starting from the leading register number.

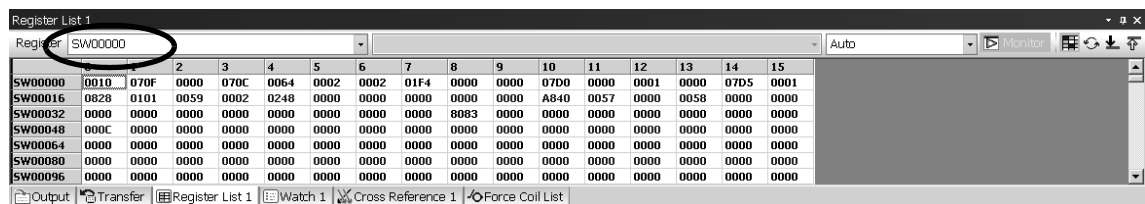

- The data type is set by default to decimal. Place the cursor anywhere on the list, and then right-click. Select **Hex** (hexadecimal) from the pop-up menu that will appear. The data will then be displayed in hexadecimal.

(2) Displaying a Register List (MPE720 Ver 5.□□)

Use the following procedure to display the MPE720 Ver 5.□□ register list.

1. Select **File – Open – Tool – Register List** from the MPE720 Ver 5.□□ main menu of **Engineering Manager** Window to open the **Register List** Window.

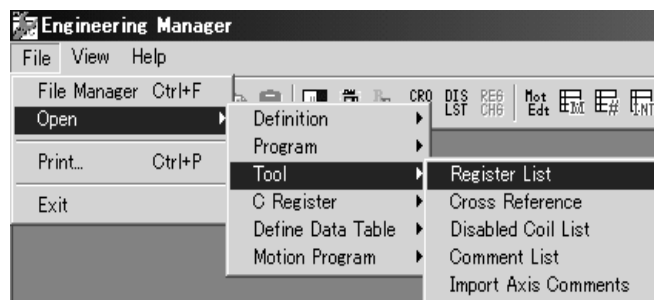

- Refer to 4.3.2 (4) *Set and Save Motion Fixed Parameters* on page 4-36 for details on how to display the **Engineering Manager** Window.

2. Select **View Mode – HEX** from the main menu to change the view mode to hexadecimal.

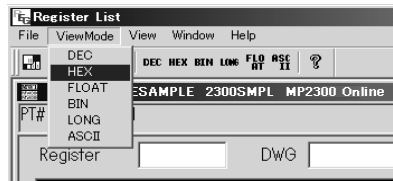

3. Input the register number of the first system register to be accessed for *Register*, input the register number of the last system register to be accessed for *ID*, and click anywhere in the list. The contents of the specified range of register numbers will be displayed.

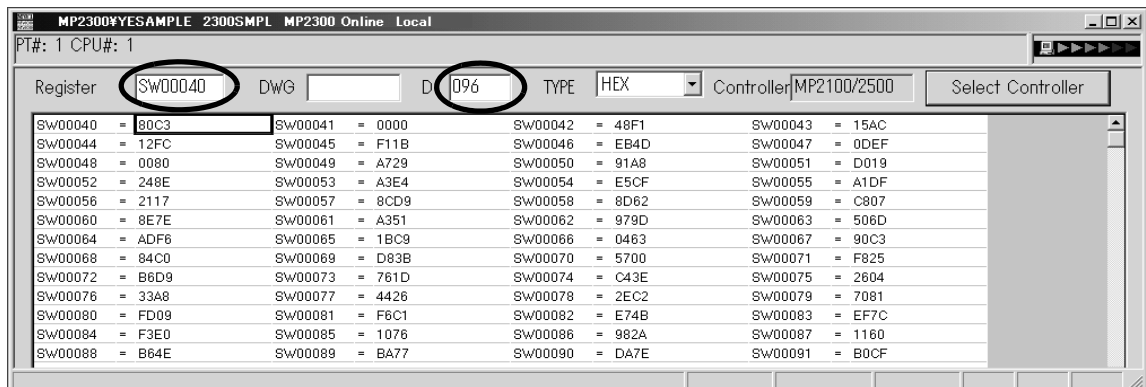

(3) Displaying a Register List with the Quick Reference (MPE720 Ver 5.□□)

Register lists can also be accessed with the Quick Reference.

1. Select **View – Quick Reference** from the main menu of MPE720 **Engineering Manager** Window.

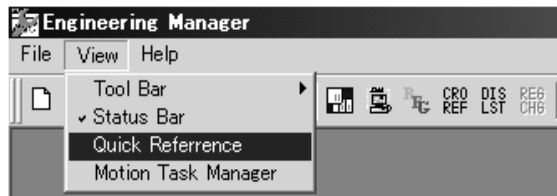

The Quick Reference will be displayed at the bottom of the **Engineering Manager** Window.

- Refer to 4.3.2 (4) *Set and Save Motion Fixed Parameters* on page 4-36 for details on how to display the **Engineering Manager** Window.

2. Click the **Register List** Tab to switch to the register list.
3. Input the register number of the first system register to be accessed for *Register*, input the register number of the last system register to be accessed for *ID*, and click anywhere in the list. The contents of the specified range of register numbers will be displayed.

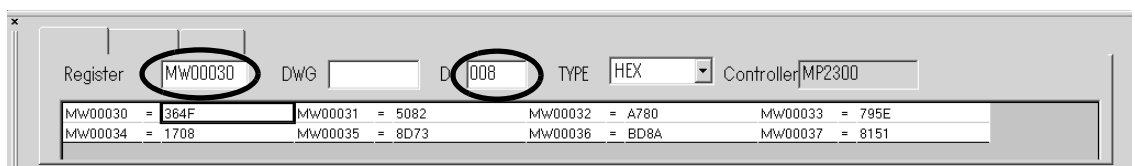

6.4.3 Troubleshooting When ERR is Lit

When the ERR lamp of the LED indicators on the front panel of MP2300 lights up, occurrence of a serious failure, hardware failure or user program error is likely. Stop the MP2300 by setting the DIP switch No. 6 (STOP) of SW1 to ON, and then investigate the cause using the following flowchart.

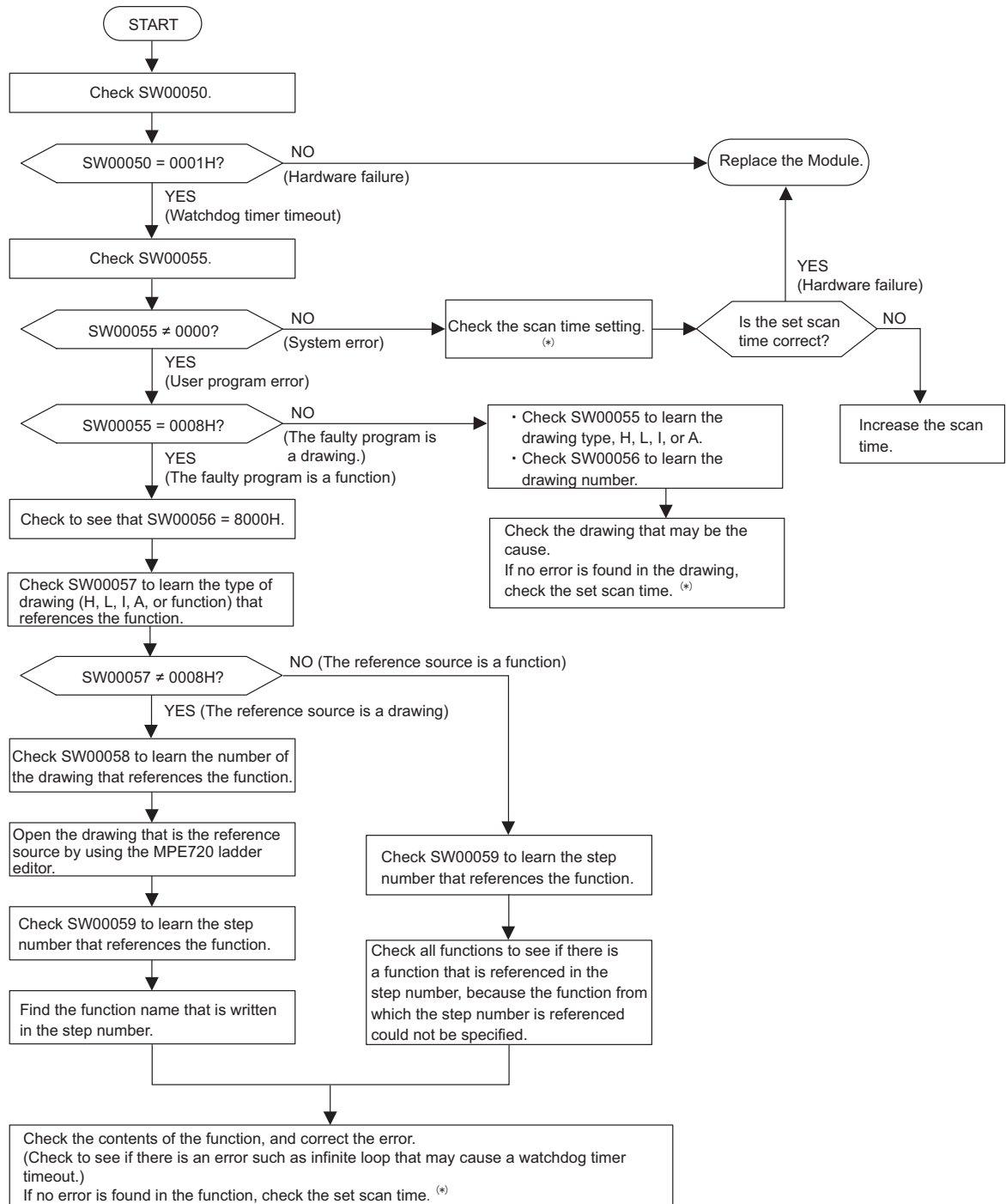

- For details on the system registers from SW00050 to SW00059, refer to 6.4.5 (2) *System Error Status*.
- Refer to 5.5.3 (1) *Precautions When Setting or Changing the Scan Time* for precautions when setting the scan time.

6.4.4 Troubleshooting When ALM is Lit

When the ALM lamp (or RDY, RUN, and ALM lamps) of the LED indicators on the front panel of MP2300 lights up, occurrence of a serious failure (hardware failure, user operation error, or I/O error) is likely. Stop the MP2300 by setting the DIP switch No. 6 (STOP) of SW1 to ON, and investigate the cause using the following flowchart.

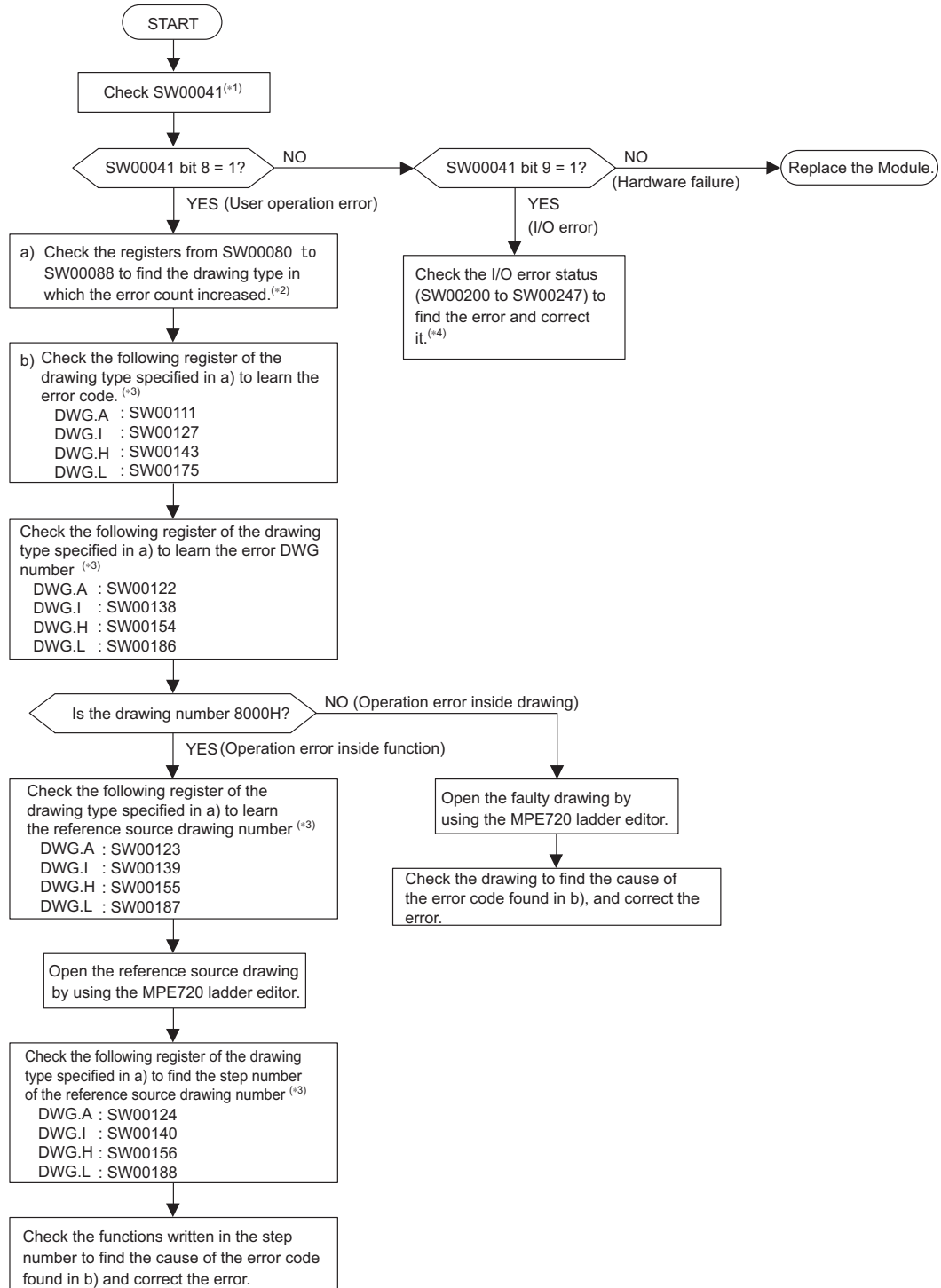

* 1. For details on SW00041, refer to 6.4.5 (2) System Error Status.

* 2. For details on the system registers from SW00080 to SW00088, refer to 6.4.5 (3) [a] Ladder Program User Operation Error Status 1.

* 3. For details on the system registers from SW00110 to SW00188, refer to 6.4.5 (3) [b] Ladder Program User Operation Error Status 2.

* 4. For details on the system registers from SW00200 to SW00247, refer to 6.4.5 (6) System I/O Error Status.

6.4.5 System Register Configuration and Error Status

(1) System Status

System operating status and error status is stored in registers SW00040 to SW00048. Checking of system status details are used to determine whether hardware or software is the cause of an error.

Name	Register No.	Description		
Reserved by the system.	SW00030 to SW00039	-		
CPU Status	SW00040	SB000400	READY	0: Failure 1: Normal
		SB000401	RUN	0: Stopped, 1: Running
		SB000402	ALARM	0: Normal, 1: Alarm
		SB000403	ERROR	0: Normal, 1: Error
		SB000404	Reserved by the system.	
		SB000405	Reserved by the system.	
		SB000406	FLASH	1: Flash operation
		SB000407	WEN	0: Write-disabled, 1: Write-enabled
		SB000408 to SB00040D	Reserved by the system.	
		SB00040E	Operation Stop Request	0: RUN selection, 1: STOP selection
		SB00040F	Run Switch Status at Power ON	0: STOP 1: RUN
CPU Error Status	SW00041	SB000410	Serious Failure	1: WDGE, undefined command See SW00050 for details.
		SB000411	Reserved by the system.	
		SB000412	Reserved by the system.	
		SB000413	Exception Error	
		SB000414 to SB000417	Reserved by the system.	
		SB000418	User operation error	1: User operation error
		SB000419	I/O Error	1: I/O error
H Scan Over Counter	SW00044	-		
		-		
L Scan Over Counter	SW00046	-		
Reserved by the system.	SW00047	SB000470 to SB00047F	Reserved by the system.	
Hardware Configuration Status	SW00048	SB000480	TEST	DIP switch alarms 0: ON, 1: OFF
		SB000481	MON	
		SB000482	CNFG	
		SB000483	INIT	
		SB000484	SUP	
		SB000485	STOP	
		SB000486	-	
		SB000487	Battery Alarm	
SB000488 to SB00048F	Reserved by the system.			

(cont'd)

Name	Register No.	Description	
Reserved by the system.	SW00049	SW000490 to SW00049F	Reserved by the system.

(2) System Error Status

System error status is stored in registers SW00050 to SW00060.

Name	Register No.	Description		
32-bit Error Code	SW00050	0001H	Watchdog timer over error	
		0041H	ROM diagnosis error	
		0042H	RAM diagnosis error	
		0043H	CPU diagnosis error	
		0044H	FPU diagnosis error	
		00E0H	Address read exception error	
		0100H	Address write exception error	
		0120H	FPU exception error	
		0180H	Illegal general command error	
		01A0H	Illegal slot command error	
		01E0H	User break after command execution	
		0800H	General FPU inhibited exception error	
		0820H	Slot FPU inhibited exception error	
	SW00051	For system error analysis		
32-bit Addresses Generating Error	SW00052	For system error analysis		
	SW00053			
Ladder Program Error Task	SW00054	0000H: System 0001H: DWG.A	0002H: DWG.I 0003H: DWG.H	0005H: DWG.L
Ladder Program Type	SW00055	0000H: System 0001H: DWG.A	0002H: DWG.I 0003H: DWG.H 0005H: DWG.L	0008H: Function 000FH: Motion program
Ladder Program Error Drawing Number	SW00056	Ladder program parent drawing: FFFFH Ladder program function: 8000H Ladder program child drawing: □□00H (H□□: Child drawing number) Ladder program grandchild drawing: □□yyH (Hyy: Grandchild drawing number) Motion program: F0□□H (H□□: Program number)		
Ladder Program Function Calling Drawing Type	SW00057	Type of drawing that calls the ladder program function in which an error occurred.		
		0001H: DWG.A 0002H: DWG.I 0003H: DWG.H 0005H: DWG.L	0008H: Ladder program function 000FH: Motion program 0010H: Reserved by system. 0011H: Reserved by system.	
Ladder Program Function Calling Drawing Number	SW00058	Number of drawing that calls the ladder program function in which an error occurred. Parent drawing: FFFFH Child drawing: □□00H (H□□: Child drawing number) Function: 0100H Grandchild drawing: □□yyH (Hyy: Grandchild drawing number)		
Ladder Program Function Calling Drawing Number	SW00059	STEP number of the drawing that calls the ladder program function in which an error occurred. 0 when there is an error in the drawing.		

Name	Register No.	Description
Error Data	SW00060 and SW00061	Reserved by the system.
	SW00062 to SW00065	Name of Task Generating Error
	SW00066 and SW00067	Reserved by the system.
	SW00068	Year Generated
	SW00069	Month Generated
	SW00070	Day of Week Generated
	SW00071	Day of Month Generated
	SW00072	Hour Generated
	SW00073	Minutes Generated
	SW00074	Seconds Generated
	SW00075	Milliseconds Generated (Not used.)
	SW00076 to SW00079	Reserved by the system.

(3) Ladder Program User Operation Error Status

Error information for user operation errors in ladder programs is stored in registers SW00080 to SW00089 (Error Status 1) and SW00110 to SW00189 (Error Status 2).

[a] Ladder Program User Operation Error Status 1

Name	Register No.	Description
DWG.A Error Count Error Code	SW00080	Operation error code: See <i>Ladder Program User Operation Error Codes 1.</i> Error code when an index error occurs: See <i>Ladder Program User Operation Error Codes 2.</i>
	SW00081	
DWG.I Error Count Error Code	SW00082	
	SW00083	
DWG.H Error Count Error Code	SW00084	
	SW00085	
Reserved by the system.	SW00086	
	SW00087	
DWG.L Error Count Error Code	SW00088	
	SW00089	

[b] Ladder Program User Operation Error Status 2

Name	Register No.				Remarks
	DWG.A	DWG.I	DWG.H	DWGL	
Error Count	SW00110	SW00126	SW00142	SW00174	<Error Drawing Number> Parent drawing: FFFFH Child drawing: □□00H (H□□: Child drawing number) Grandchild drawing: □□yyH (Hyy: Grandchild drawing number) Function: 0100H Motion program: F0□□H (H□□: Program number) <Reference Source Drawing Number> Number of the drawing reference source in which an error occurred. <Reference Source DWG Step Number> Step number of the drawing reference source in which an error occurred. 0 when there is an error in the parent drawing.
Error Code	SW00111	SW00127	SW00143	SW00175	
Error A Register	SW00112	SW00128	SW00144	SW00176	
	SW00113	SW00129	SW00145	SW00177	
Modification A Register	SW00114	SW00130	SW00146	SW00178	
	SW00115	SW00131	SW00147	SW00179	
Error F Register	SW00116	SW00132	SW00148	SW00180	
	SW00117	SW00133	SW00149	SW00181	
Modification F Register	SW00118	SW00134	SW00150	SW00182	
	SW00119	SW00135	SW00151	SW00183	
Address Generating Error	SW00120	SW00136	SW00152	SW00184	
	SW00121	SW00137	SW00153	SW00185	
Error Drawing Number	SW00122	SW00138	SW00154	SW00186	
Reference Source Drawing Number	SW00123	SW00139	SW00155	SW00187	
Reference Source DWG Step Number	SW00124	SW00140	SW00156	SW00188	
Reserved by the system.	SW00125	SW00141	SW00157	SW00189	

[c] Ladder Program User Operation Error Codes 1

	Error Code	Error Contents	User*	System Default Value	
Integer Operations	0001H	Integer operation - underflow	Yes	-32768 [-32768]	
	0002H	Integer operation - overflow	Yes	32767 [32767]	
	0003H	Integer operation - division error	Yes	The A register remains the same.	
	0009H	Double-length integer operation - underflow	Yes	-2147483648 [-2147483648]	
	000AH	Double-length integer operation - overflow	Yes	2147483647 [2147483647]	
	000BH	Double-length integer operation - division error	Yes	The A register remains the same.	
	010□H	Operation error drawing - integer operation error (□ = 1 to B)	No	Default indicated above.	
Real Number Operation	0010H	Integer storage - non-numeric error	Yes	Store not executed. [00000]	
	0011H	Integer storage - underflow	Yes	Store not executed. [-32768]	
	0012H	Integer storage - overflow	Yes	Store not executed. [+32767]	
	0021H	Real number storage - underflow	Yes	Store not executed. [-1.0E+38]	
	0022H	Real number storage - overflow	Yes	Store not executed. [1.0E+38]	
	0023H	Real number operation - division-by-zero error	Yes	Operation not executed. The F register remains the same.	
	0030H	Real number operation - invalid operation (non-numeric)	No	Operation not executed.	
	0031H	Real number operation - exponent underflow	No	0.0	
	0032H	Real number operation - exponent overflow	No	Maximum value	
	0033H	Real number operation - division error (non-numeric 0/0)	No	Operation not executed.	
	0034H	Real number storage - exponent underflow	No	Stores 0.0.	
	0035H	Real number operation - stack error			
	0040H to 0059H	Standard System Functions Real number operation errors		No	Interrupt operation and output = 0.0
		0040H: SQRT	0041H: SIN	0042H: COS	0043H: TAN
		0044H: ASIN	0045H: ACOS	0046H: ATAN	0047H: EXP
		0048H: LN	0049H: LOG	004AH: DZA	004BH: DZB
		004CH: LIM	004DH: PI	004EH: PD	004FH: PID
		0050H: LAG	0051H: LLAG	0052H: FGN	0053H: IFGN
		0054H: LAU	0055H: SLAU	0056H: REM	0057H: RCHK
0058H: BSRCH		0059H: SQRT			
1000H or 2000H is added for an index error.					

* Yes: Can be set to value other than system default from the user program.

No: The system default cannot be changed from the user program.

[d] Ladder Program User Operation Error Codes 2

	Error Code	Error Contents	User	System Default	
Integer - Real Number Operations	1000H	Index error within drawing	×	Execute again when corresponding to $i_j = 0$. The i and j registers remain the same.	
	2000H	Index error within function	×	Execute again when corresponding to $i_j = 0$. The i and j registers remain the same.	
Integer Operation	□060H to □077H (□ = 1,2)	Integer system functions Index error	×	Operation stopped and output = input. The A register remains the same.	
		□06DH: PI	□06DH: PD	□06FH: PID	□070H: LAG
		□071H: LLAG	□072H: FGN	□073H: IFGN	□074H: LAU
		□075H: SLAU	□076H: FGN	□077H: IFGN	

(4) System Service Execution Status

[a] Data Trace Execution Status

Name	Register No.	Remarks
Reserved by the system.	SW00090 to SW00097	
Existence Of Data Trace Definition	SW00098	Bit 0 to 3 = Group 1 to 4 Definition exists = 1, No definition = 0
Data Trace Execution Status	SW00099	Bit 0 to 3 = Group 1 to 4 Trace stopped = 1, Trace executing = 0

[b] Latest Data Trace Record Numbers

Name	Register No.	Remarks
Data Trace Group 1	SW00100	Latest record number
Data Trace Group 2	SW00101	Latest record number
Data Trace Group 3	SW00102	Latest record number
Data Trace Group 4	SW00103	Latest record number

(5) Alarm Counter and Alarm Clear

Name	Register No.	Remarks
Number of Alarm Occurrences	SW00190	The number of alarm occurrences.
Number of Alarm History Records	SW00191	The number of alarms in the alarm history.
Clear Alarms	SW00192	1: Alarm cleared 2: The number of alarm occurrences and alarm history cleared

(6) System I/O Error Status

Name	Register No.	Remarks
I/O Error Count	SW00200	Number of I/O errors
Input Error Count	SW00201	Number of input errors
Input Error Address	SW00202	Latest input error address (OW□□□□ register number)
Output Error Count	SW00203	Number of output errors
Output Error Address	SW00204	Latest output error address (OW□□□□ register number)
Reserved by the system.	SW00205	(Not used.)
	SW00206	
	SW00207	
I/O Error Status	SW00208 to SW00215	Slot 0 error status (Differs depending on the installed module or error code.)
	SW00216 to SW00223	Reserved by the system.
	SW00224 to SW00231	Slot 1 error status (Differs depending on the installed module or error code.)
	SW00232 to SW00239	Slot 2 error status (Differs depending on the installed module or error code.)
	SW00240 to SW00247	Slot 3 error status (Differs depending on the installed module or error code.)

(7) Details on I/O Error Status

When a system I/O error occurs, the error status will be written in the system register.

The registers allocated for each error status when an I/O Module (LIO-01/02), SVB-01 Module, and Communication Module (260IF-01) are mounted in slots 1, 2, and 3 of the MP2300 Machine Controller respectively are described below.

[a] MP2300 Machine Controller Basic Module Error Status

Name	Register No.	Remarks
Slot 0 Error Status	SW00208 to SW00215	(Depends on themounted module and error code.)
Reserved by the system	SW00216 to SW00223	(Depends on the mounted module and error code.)
Slot 1 Error Status	SW00224 to SW00231	(Depends on the mounted module and error code.)
Slot 2 Error Status	SW00232 to SW00239	(Depends on the mounted module and error code.)
Slot 3 Error Status	SW00240 to SW00247	(Depends on the mounted module and error code.)

■ Register Allocation: Slot 0 (Reserved for Basic Module)

(Bit No.)	F	8	7	0
SW00208	Error code (I/O error = 2)			Subslot No. (= 2)		
SW00209	Error code (Station error = 1)			Subslot No. (= 3)		
SW00210	ST#15	ST#2	ST#1	Not used	
SW00211	Not used	ST#30	ST#17	ST#16	
SW00212	Not used				Not used
SW00213	Not used				Not used
SW00214	Not used				Not used
SW00215	Not used				Not used

[b] LIO-01/LIO-02 Module Error Status (Slot 1)

(Bit No.)	F	8	7	0
SW00224	Error code (I/O error = 2)			Subslot No. (= 1)		
SW00225	Error code (I/O error = 2)			Subslot No. (= 2)		
SW00226	Not used				Not used
SW00227	Not used				Not used
SW00228	Not used				Not used
SW00229	Not used				Not used
SW00230	Not used				Not used
SW00231	Not used				Not used

[c] SVB-01 Module Error Status (Slot 2)

(Bit No.)	F	8	7	0	
SW00232	Error code (Station error = 1)			Subslot No. (= 1)			
SW00233	ST#15			ST#2	ST#1	Not used
SW00234	Not used	ST#30			ST#17	ST#16
SW00235	Not used					Not used
SW00236	Not used					Not used
SW00237	Not used					Not used
SW00238	Not used					Not used
SW00239	Not used					Not used

- The above error status is meant to check I/O errors when an I/O Module is connected. Errors when SERVOPACKs and/or MECHATROLINK-II inverters are connected will not be written. Use the monitoring parameter to check errors when SERVOPACKs and/or MECHATROLINK-II inverters are connected.

[d] 260IF-01 Module Error Status (Slot 3)

(Bit No.)	F	8	7	0
SW00240	Error code (Station error = 1)			Subslot No. (= 2)		
SW00241	ST#15				ST#0
SW00242	ST#31				ST#16
SW00243	ST#47				ST#32
SW00244	ST#63				ST#48

<Error Status Details>

Item	Code	Description
ST#n	0	Normal communication
	1	Communication error at the station n (n = local station number in slave mode)

(8) MP2300 Module Information

Name	Register No.	Remarks
Module Information	SW00800	Basic Module (C380H)
	SW00801	Reserved by the system.
	SW00802	CPU Software version (BCD)
	SW00803	Number of sub-slots (0004H)
	SW00804	CPU Function ID (C310H)
	SW00805	CPU Function Module Status
	SW00806	I/O Function Module ID (8070H)
	SW00807	I/O Function Module Status
	SW00808	SVB Function Module ID (9113H)
	SW00809	SVB Function Module Status
	SW00810	SVR Function Module ID (9210H)
	SW00811	SVR Function Module Status
	SW00812 to SW00815	Reserved by the system.
	SW00816 to SW00823	Slot 1
	SW00824 to SW00831	Slot 2
	SW00832 to SW00839	Slot 3
	...	
SW01008 to SW01015	Reserved by the system (Slot 26)	

(9) Motion Program Execution Information

System Work	Main Program No. in Execution	Program Information Used by Work	Motion Program Alarm							
			Parallel 0	Parallel 1	Parallel 2	Parallel 3	Parallel 4	Parallel 5	Parallel 6	Parallel 7
			Offset * +4	Offset +7	Offset +10	Offset +13	Offset +16	Offset +19	Offset +22	Offset +25
1	SW3200	SW03264 to SW03321	SW03268	SW03271	SW03274	SW03277	SW03280	SW03283	SW03286	SW03289
2	SW3201	SW03322 to SW03379	SW03326	SW03329	SW03332	SW03335	SW03338	SW03341	SW03344	SW03347
3	SW3202	SW03380 to SW03437	SW03384	SW03387	SW03390	SW03393	SW03396	SW03399	SW03402	SW03405
4	SW3203	SW03438 to SW03495	SW03442	SW03445	SW03448	SW03451	SW03454	SW03457	SW03460	SW03463
5	SW3204	SW03496 to SW03553	SW03500	SW03503	SW03506	SW03509	SW03512	SW03515	SW03518	SW03521
6	SW3205	SW03554 to SW03611	SW03558	SW03561	SW03564	SW03567	SW03570	SW03573	SW03576	SW03579
7	SW3206	SW03612 to SW03669	SW03616	SW03619	SW03622	SW06325	SW03628	SW03631	SW03634	SW03637
8	SW3207	SW03670 to SW03727	SW03674	SW03677	SW03680	SW03683	SW03686	SW03689	SW03692	SW03695
9	SW3208	SW03728 to SW03785	SW03732	SW03735	SW03738	SW03741	SW03744	SW03747	SW03750	SW03753
10	SW3209	SW03786 to SW04843	SW03790	SW03793	SW03796	SW03799	SW03802	SW03805	SW03808	SW03811
11	SW3210	SW03844 to SW03901	SW03848	SW03851	SW03854	SW03857	SW03860	SW03863	SW03866	SW03869
12	SW3211	SW03902 to SW03959	SW03906	SW03909	SW03912	SW03915	SW03918	SW03921	SW03924	SW03927
13	SW3212	SW03960 to SW04017	SW03964	SW03967	SW03970	SW03973	SW03976	SW03979	SW03982	SW03985
14	SW3213	SW04018 to SW04075	SW04022	SW04025	SW04028	SW04031	SW04034	SW04037	SW04040	SW04043
15	SW3214	SW04076 to SW04133	SW04080	SW04083	SW04086	SW04089	SW04092	SW04095	SW04098	SW04101
16	SW3215	SW04134 to SW04191	SW04138	SW04141	SW04144	SW04147	SW04150	SW04153	SW04156	SW04159

* Offset: Offset value from the first register number of Program Information Used by Work

6.5 Motion Program Alarms

If the result of investigation using 6.3.2 *MP2300 Error Check Flowchart* on page 6-6 indicates that a motion program alarm has occurred, use the alarm code to determine the cause of the error.

6.5.1 Motion Program Alarm Configuration

Motion program alarms stored in the alarm output register (default: SW03268) are displayed as shown in the following diagram.

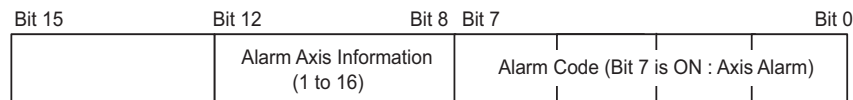

- Refer to the appropriate User's Manual of Machine Controller for information on finding the alarm output register.

6.5.2 Motion Program Alarm Code List

The motion program alarm codes are listed in the following table.

- When displaying these on the register list, set the view mode to hexadecimal.

Alarm Code	Name	Description	Corrective Actions
02h	Division error	Data divided by 0	Review the motion program.
10h	A circle instead of radius was specified	Turn number was specified instead of radius in the circular arc or helical interpolation command.	<ul style="list-style-type: none"> • Designate a center coordinate instead of a radius to perform the circular arc or helical interpolation command. • Never specify the turn number.
11h	Interpolation feeding speed over limit	Interpolation feeding speed exceeded the valid range of the FMX command.	Modify the interpolation feeding speed of the interpolation command
12h	No interpolation feeding speed specified	No interpolation feeding speed was specified. (once specified, this can be omitted as in the motion program)	Specify the interpolation feeding speed in the interpolation command.
13h	Range exceeded after converting acceleration parameter	Indirect acceleration parameter exceeded the valid range.	Change the indirect register value.
14h	Circular arc length exceeded LONG_MAX	Circular arc length exceeded the valid range in the circular arc or helical interpolation command.	Review the circular arc length in the circular arc or helical interpolation command.
15h	Vertical axis not specified for circular arc plane	Vertical axis was not specified in the circular arc or helical interpolation command.	Use PLN command to specify the axis.
16h	Horizontal axis not specified for circular arc plane	Horizontal axis was not specified in the circular arc or helical interpolation command.	Use PLN command to specify the axis.
17h	Specified axis over limit	Too many axes were configured in the circular arc (two axes) or helical (three axes) interpolation command.	Modify the axis in the circular arc or helical interpolation command.
18h	Turn number over limit	Turn number exceeded the valid range in the circular arc or helical interpolation command.	Modify the turn number in the circular arc or helical interpolation command.
19h	Radius exceeded LONG_MAX	Radius exceeded the valid range in the circular arc or helical interpolation command.	Review the radius in the circular arc or helical interpolation command.
1Ah	Center point error	Improper center point was specified in the circular arc or helical interpolation command.	Specify the center point properly in the circular arc or helical interpolation command.
1Bh	Running emergency stop command	Axis move command stopped due to a program stop request.	Turn OFF the program stop request for the motion program control signal, and turn ON the alarm reset request.
1Ch	Linear interpolation moving amount exceeded LONG_MAX	Moving amount exceeded the valid range in the linear interpolation command.	Review the moving amount in the linear interpolation command.

Alarm Code	Name	Description	Corrective Actions
1Dh	FMX undefined	FMX command not executed in the motion program containing an interpolation command.	Perform an FMX command. The FMX command is required in each program containing an interpolation command.
1Eh	Address T out of range	Designation exceeded the valid range in the IAC/IDC/FMX commands.	Review the setting in the IAC/IDC/FMX command.
1Fh	Address P out of range	Designation exceeded the valid range in the IFP command.	Review the setting in the IFP command.
21h	PFORK execution error	A motion command was instructed simultaneously at the second line in the PFORK of both a source motion program and a subprogram.	Review the source motion program or subprogram.
22h	Indirect register range error	Specified register address exceeds the register size range.	Review the motion program.
23h	Moving amount out of range	Axis moving amount with decimal point for an axis move command exceeded the possible range.	Review the axis moving amount.
80h	Use of logical axis prohibited	Multiple motion commands instructed against the same axis at the same time.	Review the motion program.
81h	Designation exceeded POSMAX in the infinite length axis	Moving distance designation exceeded POSMAX in the infinite length axis.	<ul style="list-style-type: none"> • Modify a fixed parameter “Maximum infinite length axis counter” • Review the motion program.
82h	Axis moving distance exceeded LONG_MAX	Axis moving distance designation exceeded the valid range.	Review the motion program.
84h	Duplicated motion command	Multiple commands were executed against a single axis.	Check whether another program gave a command to the same axis at the same time. If so, review the program.
85h	Motion command response error	A motion command response different from that instructed by the motion command is reported from a motion module.	<ul style="list-style-type: none"> • Remove the alarm cause from the destination axis. • If the servo is not turned ON, turn ON the servo. • Check whether another program gave a command to the same axis at the same time. If so, review the program.
87h	VEL setting data out of range	An instruction in the VEL command exceeded the valid range.	Review the VEL command.
88h	INP setting data out of range	An instruction in the INP command exceeded the valid range.	Review the INP command.
89h	ACC/SCC/DCC setting data out of range	An instruction in the ACC/SCC/DCC command exceeded the valid range.	Review the ACC/SCC/DCC command.
8Ah	No time specified in the MVT command	T designation in the MVT command was zero.	Review the MVT command.
8Bh	Command execution disabled	A motion command which cannot be executed by the destination motion module was instructed.	Review the motion program.
8Ch	Distribution incompleted	A motion command was executed when a motion module was not in the Distribution Completed state.	Review the motion program so that a motion command is executed in the Distribution Completed state.
8Dh	Motion command abnormally aborted	Motion module fell into the “Motion command abnormally aborted” state.	<ul style="list-style-type: none"> • Release the destination axis error. • Review the motion program.

* The axis number is stored in bits 8 to 12 for axis alarms.

6.6 List of Causes for Command Error Occurrence

The Command Error Completed Status (Command Error Occurrence) bit (IW□□09, bit 3) turns ON when the set motion command cannot be executed or when the execution of a motion command ends error. The triggers for which this bit turns ON depend on the motion command.

The following table describes the causes of Command Error Occurrence for each motion command.

Motion Command Code		Cause of Command Error Occurrence	Warning (W:) and Alarm (A:) That Occur at Command Error Occurrence
1	Position Mode (Positioning) (POSING)	The positioning movement exceeds the allowable range.	A: Excessive Positioning Moving Amount
		The axis is ABS infinite-length, and the zero point return setting is not completed.	A: Zero Point Unsetting
		In servo OFF status	A: Servo OFF
		Alarm is occurring.	–
		Asynchronous communication status	A: Servo Driver Synchronization Communications Error
2	Latch Torque Positioning (External positioning) (EX_POSING)	The positioning movement exceeds the allowable range.	A: Excessive Positioning Moving Amount
		The axis is ABS infinite-length, and the zero point return setting is not completed.	A: Zero Point Unsetting
		In servo OFF status	A: Servo OFF
		Alarm is occurring.	–
		Asynchronous communication status	A: Servo Driver Synchronization Communications Error
		SERVOPACK parameter writing was not completed within the specified time.	A: Servo Driver Command Timeout Error
		Warning A.94 or A.95 occurred in the SERVOPACK.	W: Servo Driver Error
The selected external signal is outside the setting range.	W: Set Parameter Error		
3	Zero Point Return (ZRET)	In machine lock status	–
		In servo OFF status	A: Servo OFF
		An alarm is occurring.	–
		Asynchronous communication status	A: Servo Driver Synchronization Communications Error
		SERVOPACK parameter reading or writing was not completed within the specified time.	A: Servo Driver Command Timeout Error
		Warning A.94 or A.95 is occurring in the SERVOPACK.	W: Servo Driver Error
		The selected zero point return method is outside the setting range.	W: Set Parameter Error
		POT method is selected for zero point return, but the approach speed is a negative value.	W: Set Parameter Error
		NOT method is selected for zero point return, but the approach speed is a positive value.	W: Set Parameter Error
		During zero point return using DEC1 + Phase-C, ZERO signal, or Phase-C method, the OT signal in zero point return direction was ON.	OT alarm or OT warning in zero point return direction

Motion Command Code		Cause of Command Error Occurrence	Warning (W:) and Alarm (A:) That Occur at Command Error Occurrence
4 and 5	Interpolation (INTERPOLATE) Last Interpolation Segment (ENDOF_INTERPOLATE)	The commanded movement for one scan exceeds the segment that can be commanded to the MECHATROLINK SERVOPACK, or the speed feed forward value exceeds the maximum allowable speed.	A: Excessive Speed
		The axis is ABS infinite length, and the zero point return (setting) is not completed.	A: Zero Point Unsetting
		In servo OFF status	A: Servo OFF
		An alarm is occurring.	–
		Asynchronous communication status	A: Servo Driver Synchronization Communications Error
6	Interpolation Mode with Latch Input (LATCH)	The commanded movement for one scan exceeds the segment that can be commanded to the MECHATROLINK SERVOPACK, or the speed feed forward value exceeds the maximum allowable speed.	A: Excessive Speed
		The axis is ABS infinite length, and the zero point return (setting) is not completed.	A: Zero Point Unsetting
		In servo OFF status	A: Servo OFF
		An alarm is occurring.	–
		The selected latch signal is out of the setting range.	W: Set Parameter Error
7	JOG Mode (FEED)	In machine lock status	–
		In servo OFF status	A: Servo OFF
		An alarm is occurring.	–
		Asynchronous communication status	A: Servo Driver Synchronization Communications Error
8	Relative Position Mode (Step mode) (STEP)	Positioning movement exceeds the allowable value.	A: Excessive Positioning Moving Amount
		In servo OFF status	A: Servo OFF
		An alarm is occurring.	–
		Asynchronous communication status	A: Servo Driver Synchronization Communications Error
9	Set Zero Point (ZSET)	An alarm is occurring.	–
		Asynchronous communication status	A: Servo Driver Synchronization Communications Error
10 and 11	Change Acceleration Time (ACC) Change Deceleration Time (DCC)	An alarm is occurring.	–
		Asynchronous communication status	A: Servo Driver Synchronization Communications Error
		Executed before distribution has been completed (DEN = OFF)	–
		SERVOPACK parameter writing was not completed within the specified time.	A: Servo Command Timeout Error
		Warning A.94 or A.95 occurred in the SERVOPACK.	W: Servo Driver Error
12	Change Filter Time Constant (SCC)	An alarm is occurring.	–
		Asynchronous communication status	A: Servo Driver Synchronization Communications Error
		Executed before distribution has been completed (DEN = OFF)	A: Filter Time Constant Change Error
		SERVOPACK parameter writing was not completed within the specified time.	A: Servo Driver Command Timeout Error
		Warning A.94 or A.95 occurred in the SERVOPACK.	W: Servo Driver Error

Motion Command Code		Cause of Command Error Occurrence	Warning (W:) and Alarm (A:) That Occur at Command Error Occurrence
13	Change Filter Type (CHG_FILTER)	An alarm is occurring.	–
		Asynchronous communication status	A: Servo Driver Synchronization Communications Error
		Executed before distribution has been completed (DEN = OFF).	A: Filter Time Constant Change Error
		The selected filter type is out of the setting range.	W: Set Parameter Error
14, 15, and 16	Change Speed Loop Gain (KVS) Change Position Loop Gain (KPS) Change Feed Forward (KFS)	An alarm is occurring.	–
		Asynchronous communication status	A: Servo Driver Synchronization Communications Error
		SERVOPACK parameter writing was not completed within the specified time.	A: Servo Driver Command Timeout Error
		Warning A.94 or A.95 occurred in the SERVOPACK.	W: Servo Driver Error
17 and 18	Read User Constant (PRM_RD) Write User Constant (PRM_WR)	An alarm is occurring.	–
		Asynchronous communication status	A: Servo Driver Synchronization Communications Error
		SERVOPACK parameter reading was not completed within the specified time.	A: Servo Driver Command Timeout Error
		Warning A.94 or A.95 occurred in the SERVOPACK.	W: Servo Driver Error
19 and 20	Alarm Monitor (ALM_MON) Alarm History Monitor (ALM_HIST)	The command to the SERVOPACK was not completed within the specified time.	A: Servo Driver Command Timeout Error
		Servo driver alarm monitor number is outside setting range.	W: Set Parameter Error
21	Clear Alarm History (ALMHIST_CLR)	The command to the SERVOPACK was not completed within the specified time.	A: Servo Driver Command Timeout Error
22	Absolute Encoder Reset (ABS_RST)	This command was used for Σ -I SERVOPACK.	–
		Executed while servo was ON.	–
		Asynchronous communication status	A: Servo Driver Synchronization Communications Error
		The command to the SERVOPACK was not completed within the specified time.	A: Servo Driver Command Timeout Error
23	Speed Reference (VELO)	Commanded while connected to MECHATROLINK-I.	–
		An alarm is occurring.	–
		Asynchronous communication status	A: Servo Driver Synchronization Communications Error
24	Torque/Thrust Reference (TRQ)	Commanded while connected to MECHATROLINK-I.	–
		An alarm is occurring	–
		Asynchronous communication status	A: Servo Driver Synchronization Communications Error
25	Phase Reference (PHASE)	The axis is ABS infinite length, and the zero point return (setting) is not completed.	A: Zero Point Unsetting
		In servo OFF status	A: Servo OFF
		An alarm is occurring.	–
		Asynchronous communication status	A: Servo Driver Synchronization Communications Error
26	Change Position Loop Integral Time Constant (KIS)	An alarm is occurring.	–
		Asynchronous communication status	A: Servo Driver Synchronization Communications Error
		SERVOPACK parameter writing was not completed within the specified time.	A: Servo Driver Command Timeout Error
		Warning A.94 or A.95 occurred in the SERVOPACK.	W: Servo Driver Error

Motion Command Code		Cause of Command Error Occurrence	Warning (W:) and Alarm (A:) That Occur at Command Error Occurrence
Others Automatic Parameter Updating when Move Command Starts *		An alarm is occurring.	–
		Asynchronous communication status	A: Servo Driver Synchronization Communications Error
		SERVOPACK parameter writing was not completed within the specified time.	A: Servo Driver Command Timeout Error
		Warning A.94 or A.95 occurred in the SERVOPACK.	W: Servo Driver Error
		The distribution was not completed (DEN = OFF).	–

* When Automatic Updating of Parameter was enabled for fixed parameters, and the settings of Filter Time Constant, Acceleration Rate/Time Constant, or Deceleration Rate/Time Constant were changed at the time a move command was set.

6.7 Troubleshooting Motion Errors

This section explains the details and remedies for errors that occur in motion control functions.

6.7.1 Overview of Motion Errors

Motion errors in the MP2300 include axis alarms detected for individual SERVOPACKs.

The failure location can be determined and appropriate corrections can be taken simply by checking the contents of the Warning (IL□□02) and Alarm (IL□□04) monitoring parameters.

The motion alarms for the MP2300 Basic Module's MECHATROLINK-I or MECHATROLINK-II functionality are shown below.

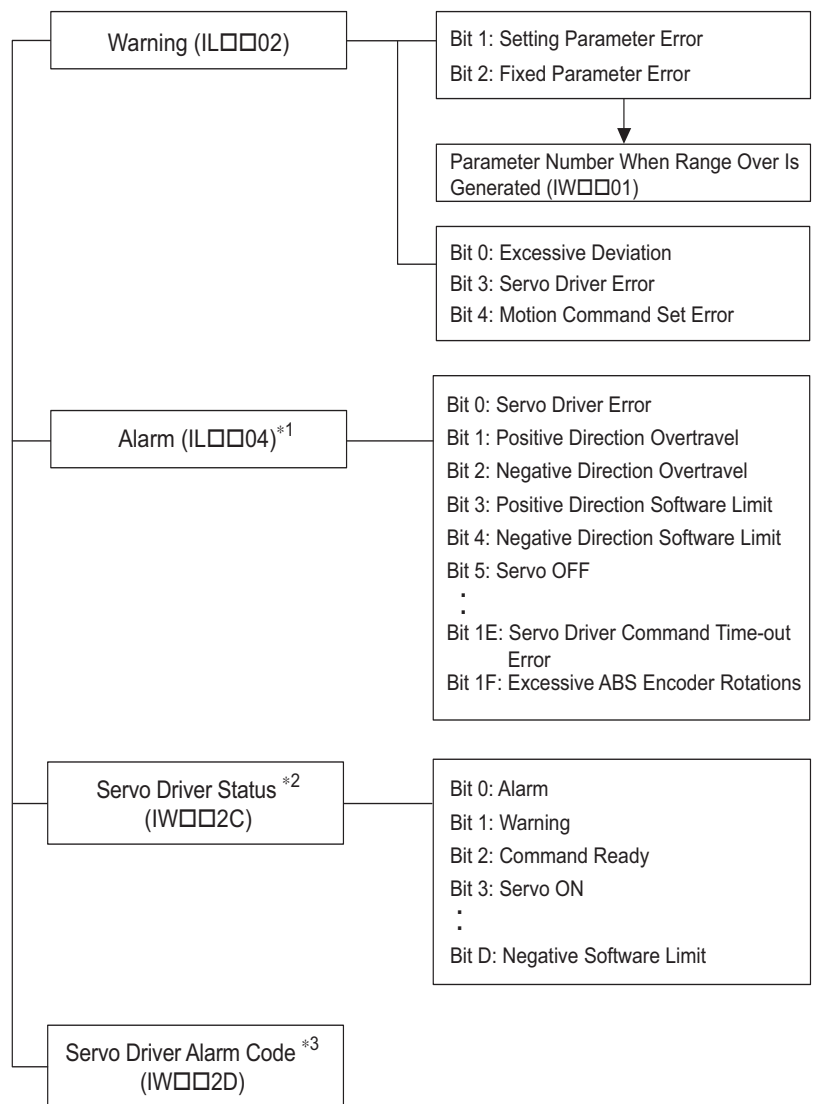

* 1. Refer to 6.7.2 *Motion Error Details and Corrections*.

* 2. Refer to 6.7.3 (1) *Servo Driver Status (IW□□2C) List*.

* 3. Refer to 6.7.3 (2) *Servo Driver Alarm Code (IW□□2D)*.

6.7.2 Motion Error Details and Corrections

The following tables show the contents of the axis alarms (IL□□04) (subsection 1) and axis alarm details (subsection 2).

(1) Alarm IL□□04 List

IL□□04	Alarm Contents	IL□□04	Alarm Contents
Bit 0	Servo Driver Error	Bit 10	Servo Driver Synchronization Communications Error
Bit 1	Positive Direction Overtravel	Bit 11	Servo Driver Communication Error
Bit 2	Negative Direction Overtravel	Bit 12	Servo Driver Command Timeout Error
Bit 3	Positive Direction Software Limit	Bit 13	Excessive ABS Encoder Rotations
Bit 4	Negative Direction Software Limit	Bit 14	Reserved by the system.
Bit 5	Servo OFF	Bit 15	Reserved by the system.
Bit 6	Positioning Time Over	Bit 16	Not used
Bit 7	Excessive Positioning Moving Amount	Bit 17	Not used
Bit 8	Excessive Speed	Bit 18	Not used
Bit 9	Excessive Deviation	Bit 19	Not used
Bit A	Filter Type Change Error	Bit 1A	Not used
Bit B	Filter Time Constant Change Error	Bit 1B	Not used
Bit C	Not used	Bit 1C	Not used
Bit D	Zero Point Unsetting	Bit 1D	Not used
Bit E	Not used	Bit 1E	Motor Type Set Error
Bit F	Not used	Bit 1F	Connected Encoder Type Error

(2) Bit 0: Servo Driver Error

Detection Timing	<ul style="list-style-type: none"> SERVOPACK alarms are continuously monitored by the alarm management section.
Processing when Alarm Occurs	<ul style="list-style-type: none"> The current command will be aborted. If a SERVOPACK error is detected during execution of a POSING command, the positioning will be aborted and the axis will decelerate to a stop. The Command Error Completed Status in the Motion Command Status (IW□□09, bit 3) will turn ON.
Error and Cause	<ul style="list-style-type: none"> The cause of the error depends on the type of alarm. The contents of an alarm is monitored in IW□□2D. Refer to the list of SERVOPACK alarms in 6.7.3 <i>Servo Driver Status and Servo Driver Error Codes</i> on page 6-36 for details.
Correction	<ul style="list-style-type: none"> Confirm the SERVOPACK alarm and remove the cause. Reset the alarm.

- The above status bit will turn ON for any of the SERVOPACK alarm codes for alarms classified as SERVOPACK alarms.

(3) Bit 1: Positive Direction Overtravel and Bit 2: Negative Direction Overtravel

Detection Timing	<ul style="list-style-type: none"> Overtravel is continuously monitored by the position management section during execution of a motion command. Overtravel is detected when the overtravel signal in the direction of movement turns OFF.
Processing when Alarm Occurs	<ul style="list-style-type: none"> The SERVOPACK performs stop processing. The stop method and processing after stopping depends on the SERVOPACK parameter settings. The Command Error Completed Status in the Motion Command Status (IW□□09, bit 3) will turn ON. Machine Controller Processing The command is canceled and the axis decelerates to a stop. Follow-up processing (each scan the current position of the machine is adjusted to the reference position) is executed.

Error and Cause	<p>One of the following is possible.</p> <ul style="list-style-type: none"> • A move command that exceeded the travel limit of the machine was executed as follows: <ul style="list-style-type: none"> A user program command exceeded the travel limit. The software limit was exceeded in manual operation. • Overtravel signal malfunction.
Correction	<ul style="list-style-type: none"> • Check the following. <ul style="list-style-type: none"> Check the overtravel signal. Check the program or manual operation. • Then, after clearing the motion command code and resetting the alarm, use a return operation to eliminate the overtravel status. (Commands in the overtravel direction will be disabled and an alarm will occur again if one is executed.)



- For a vertical axis, the following should be set at the SERVOPACK to avoid dropping and vibration at the overtravel limit.
 - An emergency deceleration stop
 - Zero clamp status after the deceleration stop

(4) Bit 3: Positive Direction Software Limit and Bit 4: Negative Direction Software Limit

Detection Timing	<ul style="list-style-type: none"> • Enabled when using a motion command and detected by the position management section. • The software limits are valid after a ZRET or ZSET command has been completed.
Processing when Alarm Occurs	<ul style="list-style-type: none"> • The axis decelerates to a stop at the software limit. • The Command Error Completed Status in the Motion Command Status (IW□□09, bit 3) will turn ON.
Error and Cause	<ul style="list-style-type: none"> • A move command that exceeded a software limit of the machine was executed as follows: <ul style="list-style-type: none"> A user program command exceeded the software limit. The software limit was exceeded in manual operation.
Correction	<ul style="list-style-type: none"> • Check the program or manual operation. • Then, after clearing the motion command code and resetting the alarm, use a return operation to eliminate the software limit status. (Commands in the direction of the software limit will be disabled and an alarm will occur again if one is executed.)

(5) Bit 5: Servo OFF

Detection Timing	<ul style="list-style-type: none"> • Servo OFF status is detected when a move command is executed.
Processing when Alarm Occurs	<ul style="list-style-type: none"> • The specified movement command will not be executed. • The Command Error Completed Status in the Motion Command Status (IW□□09, bit 3) will turn ON.
Error and Cause	<ul style="list-style-type: none"> • A move command (commands for positioning, external positioning, STEP operation, JOG operation, etc.) was executed when the SERVOPACK was Servo OFF status.
Correction	<ul style="list-style-type: none"> • After clearing the motion command and resetting the alarm, turn the SERVOPACK to the Servo ON status.

(6) Bit 6: Positioning Time Over

Detection Timing	<ul style="list-style-type: none"> • Positioning was not completed within the time specified in OW□□26 (Positioning Completion Check Time) after completing pulse distribution.
Processing when Alarm Occurs	<ul style="list-style-type: none"> • The current command was ended forcibly. • The Command Error Completed Status in the Motion Command Status (IW□□09, bit 3) will turn ON.
Error and Cause	<p>One of the following is possible.</p> <ul style="list-style-type: none"> • The position loop gain and speed loop gain are not set correctly, creating poor response. Or, there is oscillation. • The Positioning Completion Check Time (OW□□26) is too short. • The capacity of the motor is insufficient for the machine load. • Connections are not correct between the SERVOPACK and the motor.

Correction	<p>Check the following.</p> <ul style="list-style-type: none"> • Check the SERVOPACK gain parameters. • Check connections between the SERVOPACK and the motor. • Check the motor capacity. • Check the Positioning Completion Check Time (OW□□26).
------------	--

- The above check is not performed if the Positioning Completion Check Timet (OW□□26) is set to 0.

(7) Bit 7: Excessive Positioning Moving Amount

Detection Timing	• Positioning command is executed.
Processing when Alarm Occurs	<ul style="list-style-type: none"> • The move command is not executed. • The Command Error Completed Status in the Motion Command Status (IW□□09, bit 3) will turn ON.
Error and Cause	• A move command (commands for positioning, external positioning, or STEP operation) was executed that exceeded the limit of the positioning moving amount.
Correction	• Check the moving amount for the axis being positioned.

(8) Bit 8: Excessive Speed

Detection Timing	• A move command is executed.
Processing when Alarm Occurs	<ul style="list-style-type: none"> • The move command is not executed. • The Command Error Completed Status in the Motion Command Status (IW□□09, bit 3) will turn ON.
Error and Cause	• The speed (movement output for one scan in case of interpolation) commanded to MECHATROLINK servo exceeds the upper limit.
Correction	• Check the settings for speed reference, interpolation command movement per scan, and speed compensation.

(9) Bit 9: Excessive Deviation

Detection Timing	• Always, except during speed control and torque control
Processing when Alarm Occurs	<ul style="list-style-type: none"> • The move command is not executed. • The Command Error Completed Status in the Motion Command Status (IW□□09, bit 3) will turn ON.
Error and Cause	<p>One of the following is possible.</p> <ul style="list-style-type: none"> • The position loop gain and speed loop gain are not set correctly, creating poor response. • The Error Count Alarm Detection (OL□□22) is too small. • The capacity of the motor is insufficient for the machine load. • SERVOPACK failure
Correction	<p>Check the following and correct the problem. If the problem persists, contact the maintenance department.</p> <ul style="list-style-type: none"> • Check the position loop gain and speed loop gain. • Check the Error Count Alarm Detection (OL□□22). • Check the motor capacity.

- The above check is not performed if the Error Count Alarm Detection (OL□□22) is set to 0.

(10) Bit A: Filter Type Change Error

Detection Timing	• Continuously monitored by the motion command processing section.
Processing when Alarm Occurs	<ul style="list-style-type: none"> • The Change Filter Type command will not be executed. • The Command Error Completed Status in the Motion Command Status (IW□□09, bit 3) will turn ON.
Error and Cause	• An error occurs if the Change Filter Type command is executed before the specified pulse distribution has not been completed (i.e., when IW□□0C, bit 0 was OFF).
Correction	• Correct the program to execute the Change Filter Type command after Distribution Completed status (i.e., that IW□□0C, bit 0 is ON) is checked.

- The command running will not stop even if the above error occurs. The stop processing from the user program is needed to stop running commands when necessary.

(11) Bit B: Filter Time Constant Change Error

Detection Timing	• Continuously monitored by the motion command processing section.
Processing when Alarm Occurs	• The SCC (Change Filter Time Constant) command will not be executed. • The Command Error Completed Status in the Motion Command Status (IW□□09, bit 3) will turn ON.
Error and Cause	• An error occurs if the SCC command is executed before the specified pulse distribution has not been completed (i.e., when IW□□0C, bit 0 was OFF).
Correction	• Correct the program to execute the SCC command after Distribution Completed status (i.e., that IW□□0C, bit 0 is ON) is checked.

- The command running will not stop even if the above error occurs. The stop processing from the user program is needed to stop running commands when necessary.

(12) Bit D: Zero Point Unsetting

Detection Timing	• Enabled only when an absolute encoder is used for an infinite length axis and detected when the next command is set in the Motion Command (OW□□08). Commands: Positioning, External Positioning, Interpolation, Interpolation with position detection function, phase reference
Processing when Alarm Occurs	• The set command will not be executed. • The Command Error Completed Status in the Motion Command Status (IW□□09, bit 3) will turn ON.
Error and Cause	• A move command was set without executing the ZSET command (IW□□0C, bit 5 is OFF).
Correction	• After clearing the motion command and resetting the alarm, execute a Zero Point Setting operation.

(13) Bit 10: Servo Driver Synchronization Communications Error

Detection Timing	• Detected by the communication control section when communication are synchronized between the Machine Controller and SERVOPACK.
Processing when Alarm Occurs	• The current command will be aborted.
Error and Cause	• Data of either Machine Controller or servo was not correctly updated.
Correction	• Check the MECHATROLINK cable and reset the alarm.

(14) Bit 11: Servo Driver Communication Error

Detection Timing	• Detected by the communication control section when communication is not synchronized between the Machine Controller and SERVOPACK.
Processing when Alarm Occurs	• The current command will be aborted. • The SERVOPACK will be Servo OFF status.
Error and Cause	• MECHATROLINK communication stopped because the cable was disconnected, there is noise interference to the communication line or the power supply to the SERVOPACK was turned OFF.
Correction	• Check the MECHATROLINK cable and reset the alarm. • If this error occurs frequently, refer to <i>MECHATROLINK-II Installation Manual</i> (manual number: SIEPS 80000030) to correct wiring and eliminate noise interference.

(15) Bit 12: Servo Driver Command Timeout Error

Detection Timing	• Detected during execution of each motion commands. • Detected by the MECHATROLINK communication control section when the Servo command responses are checked for each process.
Processing when Alarm Occurs	• The current command will be aborted.
Error and Cause	• The MECHATROLINK Servo command did not complete within the specified time (5 s).
Correction	• Check for alarms in the SERVOPACK for MECHATROLINK communication.

- The above error occurs when Module allocations of SERVOPACK for MECHATROLINK communication have been completed and the power is not being supplied to the SERVOPACK.

(16) Bit 13: Excessive ABS Encoder Rotations

Detection Timing	<ul style="list-style-type: none"> Enabled only when an absolute encoder is used for a finite length axis, and the electronic gear used. Detected by the position management section when power is turned ON.
Processing when Alarm Occurs	<ul style="list-style-type: none"> The absolute position information read from the absolute encoder when the SEN signal turned ON is ignored.
Error and Cause	<ul style="list-style-type: none"> An operation error occurred when the absolute position information read from the absolute encoder is converted from pulses to reference units at power ON.
Correction	<ul style="list-style-type: none"> Check the gear ratio, number of encoder pulses for other motion fixed parameters.

(17) Bit 1E: Motor Type Set Error

Detection Timing	<ul style="list-style-type: none"> Detected when communications with the SERVOPACK are established.
Processing when Alarm Occurs	<ul style="list-style-type: none"> None
Error and Cause	<ul style="list-style-type: none"> The motor type setting (rotary/linear) of the Machine Controller fixed parameter does not agree with that of SERVOPACK parameter (Start Selection Pn000.3 for SGDh, Rotary/Linear for SGDS).
Correction	<ul style="list-style-type: none"> Check the setting and model of the SERVOPACK.

(18) Bit 1F: Connected Encoder Type Error

Detection Timing	<ul style="list-style-type: none"> Detected when communications with the SERVOPACK are established.
Processing when Alarm Occurs	<ul style="list-style-type: none"> None
Error and Cause	<ul style="list-style-type: none"> The motor type setting (rotary/linear) of the Machine Controller fixed parameter does not agree with the motor type connected to the SERVOPACK.
Correction	<ul style="list-style-type: none"> Check the motor.

6.7.3 Servo Driver Status and Servo Driver Error Codes

(1) Servo Driver Status (IW□□2C) List

The status of a SERVOPACK for MECHATROLINK communication can be monitored in Servo Driver Status monitoring parameter IWoo2C.

A list is provided in the following table.

Bit No.	Status	Description
Bit 0	Alarm (ALARM)	0: No alarm occurred. 1: Alarm occurred.
Bit 1	Warning (WARNG)	0: No warning occurred. 1: Warning occurred.
Bit 2	Command Ready (CMDRDY)	0: Command reception not possible (busy). 1: Command reception possible (ready).
Bit 3	Servo ON (SVON)	0: Servo OFF (baseblock) 1: Servo ON (baseblock cleared)
Bit 4	Main Power Supply ON (PON)	0: Main power OFF 1: Main power ON
Bit 5	Machine Lock (MLOCK)	0: Machine lock released 1: Machine locked
Bit 6	Zero Position (ZPOINT)	0: The APOS (absolute position) is not in the zero point. 1: The APOS (absolute position) is in the zero point range.
Bit 7	Locating Complete (PSET)	0: Pulse distribution is not completed or the APOS is not in the positioning completed width. 1: Pulse distribution is completed and the APOS is within the positioning completed width.
Bit 8	Commanded Profile Complete (DEN)	0: Pulse distribution is being performed for positioning command. 1: Pulse distribution for positioning commands has been completed
Bit 9	Torque Restriction (T_LIM)	0: A torque limit is not being applied. 1: A torque limit is being applied.
Bit A	Latch Complete (L_CMP)	0: Latch not completed. 1: Latch completed.
Bit B	Locating Neighborhood (NEAR)	0: The APOS is outside the NEAR Signal Output Width. 1: The APOS is inside the NEAR Signal Output Width.
Bit C	Position Software Limit (P-SOT)	0: The positive software limit has not been exceeded. 1: The positive software limit has been exceeded.
Bit D	Negative Software Limit (N-SOT)	0: The negative software limit has not been exceeded. 1: The negative software limit has been exceeded.
Bit E	Reserved	–
Bit F	Reserved	–

(2) Servo Driver Alarm Code (IW□□2D)

When the Servo Driver Error (IL□□04, bit 0) turns ON, a SERVOPACK alarm will exist. The content of the alarm can be confirmed using the Servo Driver Alarm Code (monitoring parameter IW□□2D).

The Servo alarm codes are listed in the following tables.

[a] Σ -I Series

Name	Register Number	Code	Meaning
Servo Driver Alarm Code	IW□□2D	99	Normal
		94	Parameter Setting Warning
		95	MECHATROLINK Command Warning
		96	MECHATROLINK Communication Error Warning
		00	Absolute Value Data Error
		02	Parameter Corrupted
		10	Overcurrent
		11	Ground Fault
		40	Overvoltage
		41	Undervoltage
		51	Excessive Speed
		71	Overload (Instantaneous)
		72	Overload (Continuous)
		7A	Heat Sink Heating
		80	Absolute Encoder Error
		81	Absolute Encoder Backup Error
		82	Absolute Encoder Checksum Error
		83	Absolute Encoder Battery Error
		84	Absolute Encoder Data Error
		85	Absolute Encoder Excessive Speed
		B1	Gate Array 1 Error
		B2	Gate Array 2 Error
		B3	Current Feedback Phase-U Error
		B4	Current Feedback Phase-V Error
		B5	Watchdog Detector Error
		C1	Servo Run-away
		C2	Encoder Phase Error Detected
		C3	Encoder Phase-A or -B Disconnection
		C4	Encoder Phase-C Disconnection
		C5	Incremental Encoder Initial Pulses Error
		D0	Position Error Exceeded
		E5	MECHATROLINK Sync Error
E6	MECHATROLINK Communication Error		
F1	Open Phase in Power Line		
F3	Momentary Power Loss		

[b] Σ -II Series

Name	Register Number	Code	Meaning
Servo Driver Alarm Code	IW□□2D	99	Normal
		90	Excessive Position Deviation Warning
		91	Overload Warning
		92	Regeneration Overload Warning
		93	Absolute Encoder Battery Error
		94	Data Setting Warning
		95	Command Warning
		96	Communication Warning
		02	Parameter Corrupted
		03	Main Circuit Detector Error
		04	Parameter Setting Error
		05	Combination Error
		09	Divider Setting Error
		0A	Encoder Type Unmatch
		10	Overcurrent or Heat Sink Overheat
		30	Regeneration Error
		32	Regeneration Overload
		33	Main Circuit Wiring Error
		40	Overvoltage
		41	Undervoltage
		51	Excessive Speed
		71	Overload (Instantaneous Maximum Load)
		72	Overload (Continuous Maximum Load)
		73	DB Overload
		74	Inrush Resistance Overload
		7A	Heat Sink Overheat
		81	Encoder Backup Alarm
		82	Encoder Checksum Alarm
		83	Encoder Battery Alarm
		84	Encoder Data Alarm
		85	Encoder Excessive Speed
		86	Encoder Overheat
		B1	Speed Reference A/D Error
		B2	Torque Reference A/D Error
		B3	Current Sensor Error
		B6	Gate Array Error
		BF	System Alarm
		C1	Servo Run-away
		C6	Full-closed Loop Phase-A or -B Disconnection
		C7	Full-closed Loop Phase-C Disconnection
		C8	Encoder Clear Error Multiturn Limit Setting Error
C9	Encoder Communication Error		
CA	Encoder Parameter Error		
CB	Encoder Echoback Error		
CC	Multiturn Limit Mismatch		
D0	Excessive Position Error		
D1	Excessive Error between Motor and Load		
E0	No Option		
E1	Option Timeout		

Name	Register Number	Code	Meaning
Servo Driver Alarm Code (cont'd)	IW□□2D (cont'd)	E2	Option WDC Error
		E5	WDT Error
		E6	Communication Error
		E7	Application Module Detection Failure
		E9	Bus OFF Error
		EA	SERVOPACK Failure
		EB	SERVOPACK Initial Access Error
		EC	SERVOPACK WDC Error
		ED	Command Execution Not Completed
		EF	Application Module Alarm
		F1	Open Phase in Power Line
		F5	Motor Wire Disconnection (when control power supply is turned ON)
		F6	Motor Wire Disconnection (when Servo is ON)

[c] Σ -III Series

Name	Register Number	Code	Meaning
Servo Driver Alarm Code	IW□□2D	000	Normal
		900	Excessive Position Error
		901	Excessive Position Error at Servo ON
		910	Overload
		911	Vibration
		920	Regeneration Overload
		930	Absolute Encoder Battery Error
		941	Parameter Change Requiring Power Recycling
		94A	Data Setting Warning 1 (Parameter Number)
		94B	Data Setting Warning 2 (Outside Data Range)
		94C	Data Setting Warning 3 (Calculation Error)
		94D	Data Setting Warning 4 (Parameter Size)
		95A	Command Warning 1 (Command Conditions Not Met)
		95B	Command Warning 2 (Unsupported Command)
		95C	Command Warning 3
		95D	Command Warning 4
		95E	Command Warning 5
		960	MECHATROLINK Communication Warning
		020	Parameter Checksum Error 1
		021	Parameter Format Error 1
		022	System Constant Checksum Error 1
		023	Parameter Password Error 1
		02A	Parameter Checksum Error 2
		02B	System Constant Checksum Error 2
		030	Main Circuit Detector Error
		040	Parameter Setting Error 1
		04A	Parameter Setting Error 2
		041	Divided Pulse Output Setting Error
		042	Parameter Combination Error
		050	Combination Error
		051	Unsupported Product Alarm

Name	Register Number	Code	Meaning
Servo Driver Alarm Code (cont'd)	IW□□2D (cont'd)	0B0	Servo ON Reference Invalid Alarm
		100	Overcurrent or Heat Sink Overheat
		300	Regeneration Error
		320	Regeneration Overload
		330	Main Circuit Wiring Error
		400	Overvoltage
		410	Undervoltage
		510	Excessive Speed
		511	Divided Pulse Output Excessive Speed
		520	Vibration Alarm
		710	Overload (Instantaneous Maximum Load)
		720	Overload (Continuous Maximum Load)
		730, 731	DB Overload
		740	Inrush Resistance Overload
		7A0	Heat Sink Overheat
		810	Encoder Backup Alarm
		820	Encoder Checksum Alarm
		830	Encoder Battery Alarm
		840	Encoder Data Alarm
		850	Encoder Over Speed
		860	Encoder Overheat
		870	Fully-closed Serial Encoder Checksum Alarm
		880	Fully-closed Serial Encoder Data Alarm
		8A0	Fully-closed Serial Encoder Scale Error
		8A1	Fully-closed Serial Encoder Module Error
		8A2	Fully-closed Serial Encoder Sensor Error (Incremental Value)
		8A3	Fully-closed Serial Encoder Position Error (Absolute Value)
		B31	Current Detection Error 1
		B32	Current Detection Error 2
		B33	Current Detection Error 3
		B6A	MECHATROLINK Communication ASIC Error 1
		B6B	MECHATROLINK Communication ASIC Error 2
		BF0	System Alarm 0
		BF1	System Alarm 1
		BF2	System Alarm 2
		BF3	System Alarm 3
		BF4	System Alarm 4
		C10	Servo Run-away
		C80	Encoder Clear Error Multiturn Limit Setting Error
		C90	Encoder Communication Error
		C91	Encoder Communication Position Data Acceleration Error
C92	Encoder Communication Timer Error		
CA0	Encoder Parameter Error		
CB0	Encoder Echoback Error		
CC0	Multiturn Limit Mismatch		
CF1	Fully-closed Serial Conversion Unit Communication Error (Reception Failure)		

Name	Register Number	Code	Meaning
Servo Driver Alarm Code (cont'd)	IW□□2D (cont'd)	CF2	Fully-closed Serial Conversion Unit Communication Error (Timer Stopped)
		D00	Excessive Position Error
		D01	Excessive Position Error Alarm at Servo ON
		D02	Excessive Position Error Alarm for Speed Limit at Servo ON
		D10	Excessive Error between Motor and Load
		E00	COM Alarm 0
		E01	COM Alarm 1
		E02	COM Alarm 2
		E07	COM Alarm 7
		E08	COM Alarm 8
		E09	COM Alarm 9
		E40	MECHATROLINK-II Transmission Cycle Setting Error
		E50	MECHATROLINK-II Sync Error
		E51	MECHATROLINK-II Sync Failure
		E60	MECHATROLINK-II Communication Error
		E61	MECHATROLINK-II Transmission Cycle Error
		EA0	DRV Alarm 0
		EA1	DRV Alarm 1
EA2	DRV Alarm 2		

- Alarm codes are normally two digits, but three-digit codes are stored in the Alarm Monitor for motion commands.

■ Σ -V Series

Name	Register Number	Code	Meaning
Servo Driver Alarm Code	IW□□2D	020	Parameter Checksum Error
		021	Parameter Format Error
		022	System Checksum Error
		023	Parameter Password Error
		030	Main Circuit Detector Error
		040	Parameter Setting Error
		041	Divided Pulse Output Setting Error
		042	Parameter Combination Error
		044	Semi-closed/Fully-closed Parameter Setting Error
		050	Combination Error
		051	Unsupported Product Alarm
		0b0	Servo ON Reference Invalid Alarm
		100	Overcurrent
		300	Regeneration Error
		320	Regeneration Overload
		330	Main Circuit Wiring Error
		400	Overvoltage
		410	Undervoltage
		510	Overspeed
		511	Divided Pulse Output Overspeed
		520	Vibration Alarm
		521	Autotuning Alarm
710	Overload (Instantaneous Maximum Load)		
720	Overload (Continuous Maximum Load)		
730	DB Overload		
731			

Name	Register Number	Code	Meaning
Servo Driver Alarm Code (cont'd)	IW□□2D (cont'd)	740	Inrush Resistance Overload
		7A0	Heat Sink Overheat
		7AB	SERVOPACK's Built-in Fan Error
		810	Encoder Backup Alarm
		820	Encoder Checksum Alarm
		830	Encoder Battery Alarm
		840	Encoder Data Alarm
		850	Encoder Overspeed
		860	Encoder Overheat
		891	Encoder Module Error
		8A0	External Encoder Scale Error
		8A1	External Encode Module Error
		8A2	External Encoder Sensor Error (Incremental)
		8A3	External Encoder Position Error (Absolute)
		b10	Speed Reference A/D Error
		b11	Speed Reference A/D Data Conversion Error
		b20	Torque Reference A/D Error
		b31	Current Detection Error 1
		b32	Current Detection Error 2
		b33	Current Detection Error 3
		bF0	System Alarm 0 (Scan C Error)
		bF1	System Alarm 1 (CPU Stack Memory Error)
		bF2	System Alarm 2 (Program Error for Current Control Processing)
		bF3	System Alarm 3 (Scan A Error)
		bF4	System Alarm 4 (CPUWDT Error)
		C10	Overrun Protection Detection
		C20	Phase Detection Error ^{*1}
		C21	Hall Sensor Error ^{*1}
		C22	Phase Information Mismatch ^{*1}
		C50	Magnetic Pole Detection Failure ^{*1}
		C51	Overtravel Detection at Magnetic Pole Detection ^{*1}
		C52	Magnetic Pole Detection Incomplete ^{*1}
		C53	Magnetic Pole Detection Range Over
		C54	Magnetic Pole Detection Error 2
		C80	Encoder Clear Error (Multiturn Limit Setting Error)
		C90	Encoder Communications Error
		C91	Acceleration Data Error at Encoder Communications Position
		C92	Encoder Communications Timer Error
		CA0	Encoder Parameter Error
		Cb0	Encoder Ecoback Error
		CC0	Multiturn Limit Mismatch
		CF1	Fully-closed Serial Conversion Unit Communications Error ^{*1}
		CF2	Fully-closed Serial Conversion Unit Communications Error ^{*1}
		d00	Excessive Position Error
		d01	Excessive Position Error Alarm at Servo ON
		d02	Excessive Position Error Alarm for Speed Limit at Servo ON
		d10	Excessive Error between Motor Load and Position
EB0	Safety Function Drive Monitor Circuit Error ^{*2}		
EB1	Safety Function Signal Input Timing Error		
EB2	Safety Function Drive Internal Signal Error 1 ^{*2}		

Name	Register Number	Code	Meaning
Servo Driver Alarm Code (cont'd)	IW□□2D (cont'd)	EB3	Safety Function Drive Communications Error 1* ²
		EB4	Safety Function Drive Communications Error 2* ²
		EB5	Safety Function Drive Communications Error 3* ²
		EB6	Safety Function Drive Communications Data Error 3* ²
		EC7	Safety Option Card Stop Command Error* ²
		F10	Power Line Open Phase
		CPF00	Digital Operator Communications Error 1
		CPF01	Digital Operator Communications Error 2
--		Does not indicate an error.	

* 1. When the feedback option is used.

* 2. When the safety function is used.

Appendices

A	System Registers Lists	A-2
A.1	System Service Registers	A-2
A.2	Scan Execution Status and Calendar	A-4
A.3	Program Software Numbers and Remaining Program Memory Capacity Name	A-4
B	Current Values and Set Values (Input Data) in the SVB Definition Window	A-5
B.1	Operations and Parameter Data Flow	A-5
B.2	Precautions When Saving SERVOPACK Parameters	A-12
C	Initializing the Absolute Encoder	A-13
C.1	Initializing Procedures for Σ -V and Σ -III Series SERVOPACKs	A-13
C.2	Σ -II SERVOPACK	A-15
C.3	Σ -I SERVOPACK	A-17
D	Motion Parameter Lists	A-19
D.1	Fixed Parameter List	A-19
D.2	Setting Parameter List	A-20
D.3	Monitoring Parameter List	A-25

A System Registers Lists

A.1 System Service Registers

(1) Shared by All Drawings

Name	Register No.	Remarks
Reserved (Reserved for the system)	SB000000	(Not used)
First High-speed Scan	SB000001	ON for only the first scan after high-speed scan is started.
First Low-speed Scan	SB000003	ON for only the first scan after low-speed scan is started.
Always ON	SB000004	Always ON (= 1)
Reserved (Reserved for the system)	SB000005 to SB00000F	(Not used)



(2) DWG.H Only

The following relays begin operation at the start of the high-speed scan.

Name	Register No.	Remarks
1-scan Flicker Relay	SB000010	
0.5-s Flicker Relay	SB000011	
1.0-s Flicker Relay	SB000012	
2.0-s Flicker Relay	SB000013	
0.5-s Sampling Relay	SB000014	
1.0-s Sampling Relay	SB000015	
2.0-s Sampling Relay	SB000016	
60.0-s Sampling Relay	SB000017	
1.0 s After Start of Scan Relay	SB000018	
2.0 s After Start of Scan Relay	SB000019	
5.0 s After Start of Scan Relay	SB00001A	

(3) DWG.L Only

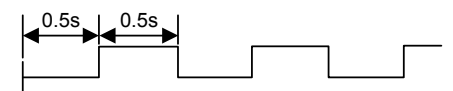
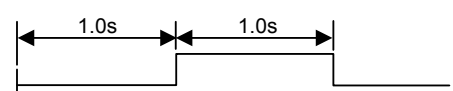
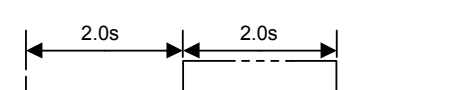
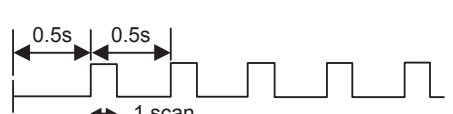
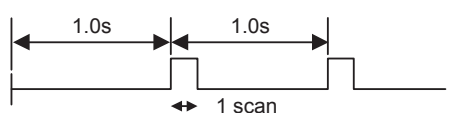
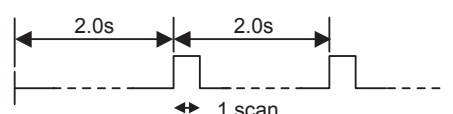
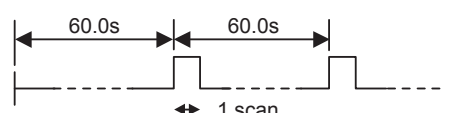
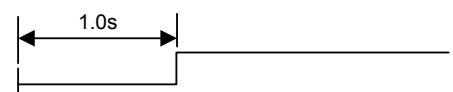
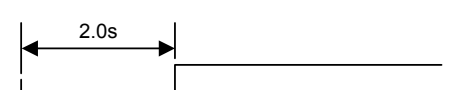
The following relays begin operation at the start of the low-speed scan.

Name	Register No.	Remarks
One-scan Flicker Relay	SB000030	
0.5-s Flicker Relay	SB000031	
1.0-s Flicker Relay	SB000032	
2.0-s Flicker Relay	SB000033	
0.5-s Sampling Relay	SB000034	
1.0-s Sampling Relay	SB000035	
2.0-s Sampling Relay	SB000036	
60.0-s Sampling Relay	SB000037	
1.0 s After Start of Scan Relay	SB000038	
2.0 s After Start of Scan Relay	SB000039	
5.0 s After Start of Scan Relay	SB00003A	

A.2 Scan Execution Status and Calendar

Name	Register No.	Remarks
High-speed Scan Set Value	SW00004	High-speed Scan Set Value (0.1 ms)
High-speed Scan Current Value	SW00005	High-speed Scan Current Value (0.1 ms)
High-speed Scan Maximum Value	SW00006	High-speed Scan Maximum Value (0.1 ms)
Reserved by the system.	SW00007 to SW00009	(Not used)
Low-speed Scan Set Value	SW00010	Low-speed Scan Set Value (0.1 ms)
Low-speed Scan Current Value	SW00011	Low-speed Scan Current Value (0.1 ms)
Low-speed Scan Maximum Value	SW00012	Low-speed Scan Maximum Value (0.1 ms)
Reserved by the system.	SW00013	(Not used)
Executing Scan Current Value	SW00014	Executing Scan Current Value (0.1 ms)
Calendar: Year	SW00015	1999: 0099 (BCD) (Last two digits only)
Calendar: Month Day	SW00016	December 31: 1231 (BCD)
Calendar: Hours Minutes	SW00017	23 hours 59 minutes: 2359 (BCD)
Calendar: Seconds	SW00018	59 s: 59 (BCD)
Calendar: Day of Week	SW00019	0 to 6: Sun., Mon. to Sat.

A.3 Program Software Numbers and Remaining Program Memory Capacity Name

Name	Register No.	Remarks
System Program Software Number	SW00020	S□□□□ (□□□□ is stored as BCD)
System Number	SW00021 to SW00025	(Not used)
Remaining Program Memory Capacity	SW00026	Bytes
Total Memory Capacity	SW00028	Bytes

B Current Values and Set Values (Input Data) in the SVB Definition Window

In systems connected to MECHATROLINK, SERVOPACK parameters can be read directly from the MP2300. (Refer to 11.6 Parameters That Are Automatically Updated in the Machine Controller MP2000 Series Built-in SVB/SVB-01 Motion Module User's Manual (Manual No.: SIEPC88070033). This means that parameters are saved in the memory area of both the MP2300 and the SERVOPACK. It is thus necessary to consider the relationship between the settings in both memory areas.

B.1 Operations and Parameter Data Flow

(1) Power ON

- Parameter data saved in the SERVOPACK's EEPROM*1 is copied to SERVOPACK's RAM.
 - Parameter data saved in the MP2300's flash memory*1 for all axes is copied to SDRAM*2.
- Some gain-related settings are sent from the MP2300 to SERVOPACK RAM*1.

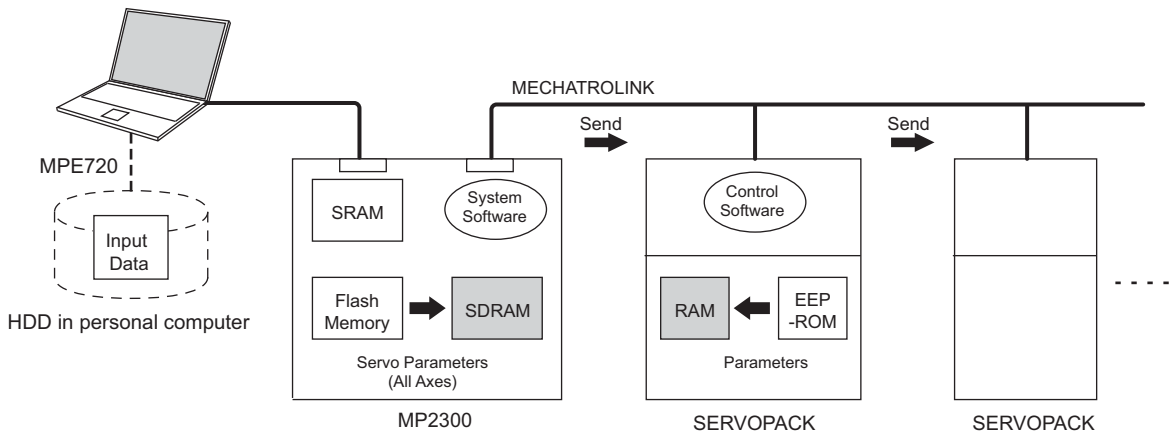

- * 1. EEPROM, flash memory, and SRAM: Store data even when the power is turned OFF.
- * 2. RAM (SRAM, SDRAM): Lose data when the power is turned OFF.
- Indicates data has been written (same below).

(2) Normal Operation

- Control software of the SERVOPACK operates based on the parameter data held in SERVOPACK's RAM.
- Some of MP2300 setting parameters and commands temporarily change SERVOPACK parameters*. RAM in the SERVOPACK are written.

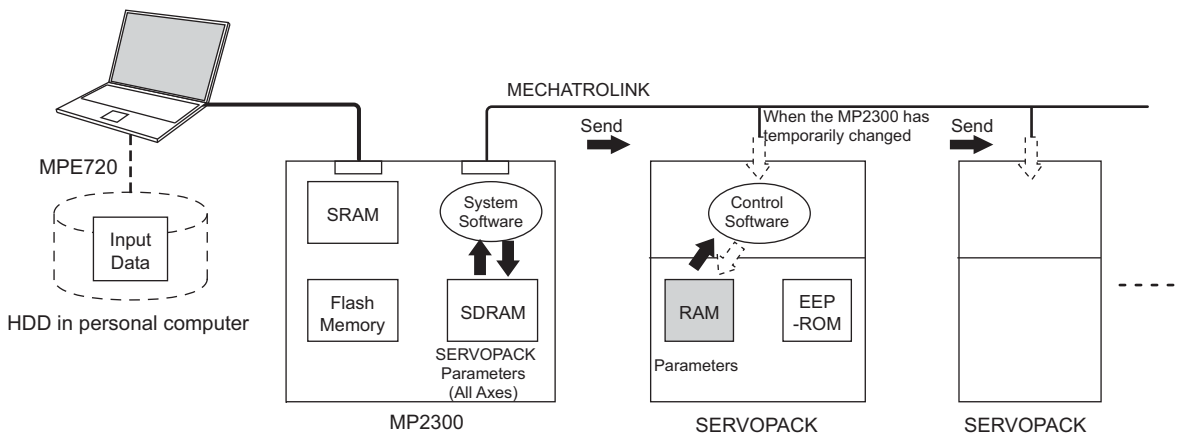

- * Refer to 4 Motion Parameters of the Machine Controller MP2000 Series Built-in SVB/SVB-01 Motion Module User's Manual (Manual No.: SIEPC88070033).
- Parameters held in the SERVOPACK's RAM are displayed on a Digital Operator connected to the SERVOPACK. They are also written to EEPROM when the DATA/ENTER Key is pressed.

(3) When the SERVOPACK Tab Page Is Open

The data flow for SERVOPACK parameters is as follows when the SERVOPACK Tab Page is open in the SVB Definitions Window on the MPE720 (refer to 2.2.5 (2) [a] Opening the SVB Definition Window on page 2-23 for details on how to open the **SERVOPACK** Tab Page.):

- The MPE720 writes and displays the parameters that are held in the SERVOPACK's RAM for the relevant axis to the *Current Value* in the **SERVOPACK** Tab Page.
It also reads and displays the values that are held in the MP2300's SDRAM values to the *Input Data* in the **SERVOPACK** Tab.

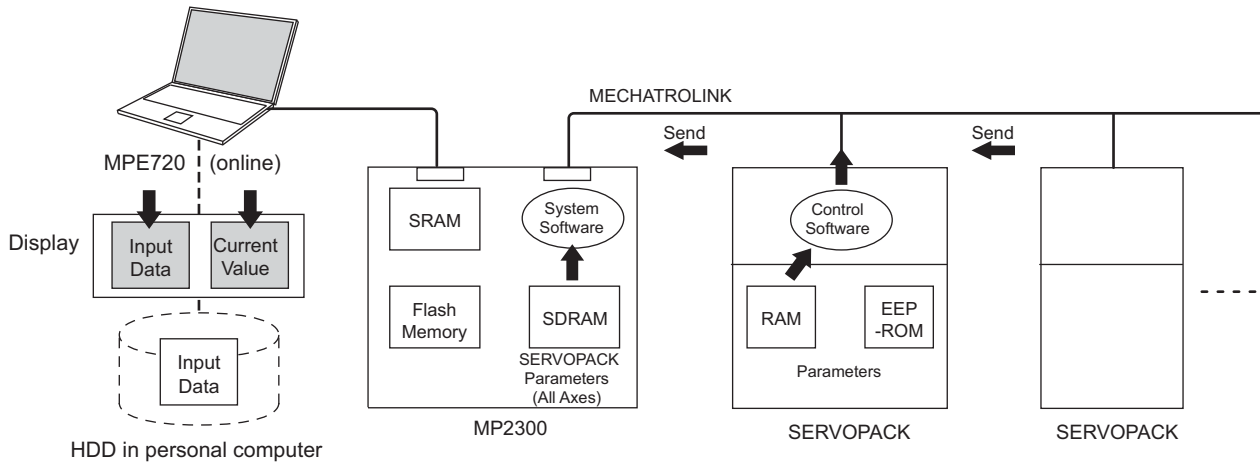

The following figure shows an example of the **SERVOPACK** Tab in the **SVB Definition** Window. The values in *Current Value* are different from the values in *Input Data*.

Engineering Manager - [SVB Definition MP2300\YESAMPLE 23005MPL MP2300 Online Local]

PT#: 2 IP#:192.168.1.1 CPU#: 1 RACK#01 Slot #00 CIR#01 8000-87FF

Axis 1 SERVOPACK SGDS-***1** Version 0014 Servo Type Rotary

No.	Name	Input Data	Unit	Current
0000	Function Selection Basic Switch 0	0000 H	-	0000 H
0001	Function Selection Application Switch 1	0000 H	-	0000 H
0002	Function Selection Application Switch 2	0011 H	-	0111 H
0004	Function Selection Application Switch 4	0110 H	-	0110 H
0006	Function Selection Application Switch 6	0002 H	-	0002 H
0007	Function Selection Application Switch 7	0000 H	-	0000 H
0008	Function Selection Application Switch 8	4000 H	-	4000 H
0100	Speed Loop Gain	40.0 Hz	100.0	100.0
0101	Speed Loop Integral Time Constant	20.00 ms	40.00	40.00
0102	Position Loop Gain	40.0 /s	100.0	100.0
0103	Moment of Inertia Ratio/Mass ratio.	0%	0	0
0104	2nd Speed Loop Gain	40.0 Hz	40.0	40.0
0105	2nd Speed Loop Integral Time Constant	20.00 ms	20.00	20.00
0106	2nd Position Loop Gain	40.0 /s	40.0	40.0
0107	Bias	0 min-1	0	0

(4) SERVOPACK Parameters Saved in the SERVOPACK Tab Page

The data flow for SERVOPACK parameters is as follows when **File – Save** is selected from the **SERVOPACK** Tab Page:

- The MPE720 writes all the parameters in *Input Data* currently displayed on **SERVOPACK** Tab Page of the relevant axis to the followings.
 - HDD (hard disk) of the personal computer
 - SDRAM of MP2300
 - RAM and EEPROM of the SERVOPACK
- After having completed writing the parameters, the MPE720 updates the values in *Current Value* on the **SERVOPACK** Tab Page with the SERVOPACK parameter values stored in the RAM.

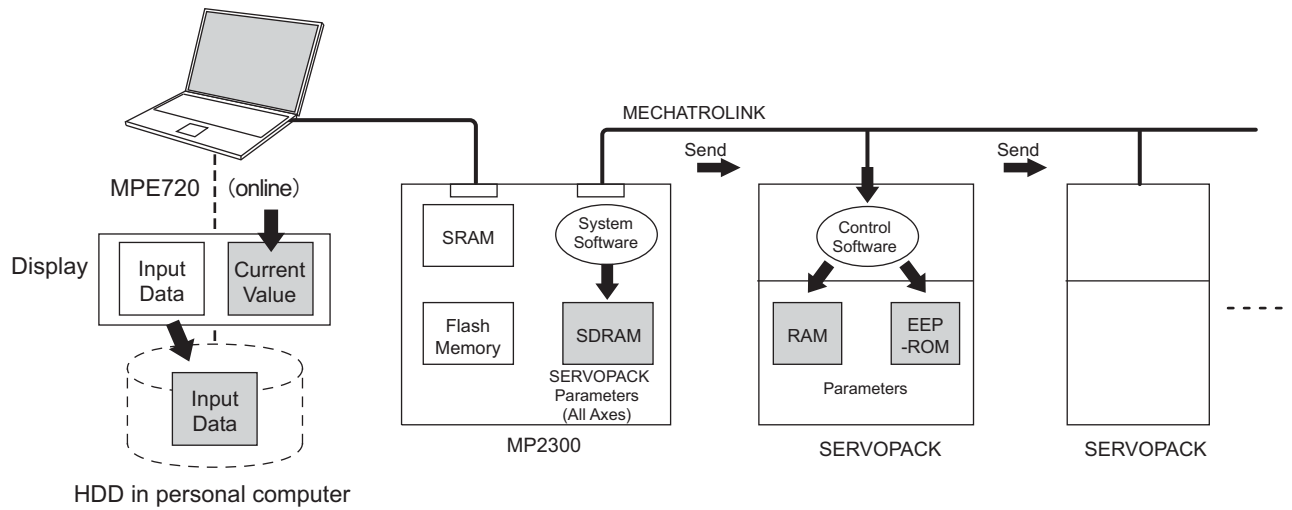

The following figure shows a display example after having executed save operation on the **SERVOPACK** Tab Page in the **SVB Definition** Window. After having saved the data, the values in *Input Data* of all the parameters become the same as the values in *Current Value* on the **SERVOPACK** Tab Page.

Before saving

No.	Name	Input Data	Unit	Current
0000	Function Selection Basic Switch 0	0000 H	-	0000 H
0001	Function Selection Application Switch 1	0000 H	-	0000 H
0002	Function Selection Application Switch 2	0011 H	-	0111 H
0004	Function Selection Application Switch 4	0110 H	-	0110 H
0006	Function Selection Application Switch 6	0002 H	-	0002 H
0007	Function Selection Application Switch 7	0000 H	-	0000 H
0008	Function Selection Application Switch 8	4000 H	-	4000 H
0100	Speed Loop Gain	40.0 Hz		100.0
0101	Speed Loop Integral Time Constant	20.00 ms		40.00
0102	Position Loop Gain	40.0 /s		100.0
0103	Moment of Inertia Ratio/Mass ratio.	0 %		0
0104	2nd Speed Loop Gain	40.0 Hz		40.0
0105	2nd Speed Loop Integral Time Constant	20.00 ms		20.00

After saving

No.	Name	Input Data	Unit	Current
0000	Function Selection Basic Switch 0	0000 H	-	0000 H
0001	Function Selection Application Switch 1	0000 H	-	0000 H
0002	Function Selection Application Switch 2	0111 H	-	0111 H
0004	Function Selection Application Switch 4	0110 H	-	0110 H
0006	Function Selection Application Switch 6	0002 H	-	0002 H
0007	Function Selection Application Switch 7	0000 H	-	0000 H
0008	Function Selection Application Switch 8	4000 H	-	4000 H
0100	Speed Loop Gain	40.0 Hz		40.0
0101	Speed Loop Integral Time Constant	20.00 ms		20.00
0102	Position Loop Gain	40.0 /s		40.0
0103	Moment of Inertia Ratio/Mass ratio.	0 %		0
0104	2nd Speed Loop Gain	40.0 Hz		40.0
0105	2nd Speed Loop Integral Time Constant	20.00 ms		20.00

- The saving operation of SERVOPACK parameters can be used for writing data after SERVOPACK replacement because it writes all the parameters of the relevant axis.

(5) Copying Current Values to Set Values (Input Data) in the SERVOPACK Tab Page

The data flow for SERVOPACK parameters is as follows when selecting *Edit - Copy Current Value* from the **SERVOPACK** Tab Page in the **SVB Definition** Window on the MPE720:

- The MPE720 copies the values currently displayed in *Current Value* to *Input Data* on the **SERVOPACK** Tab Page and displays.

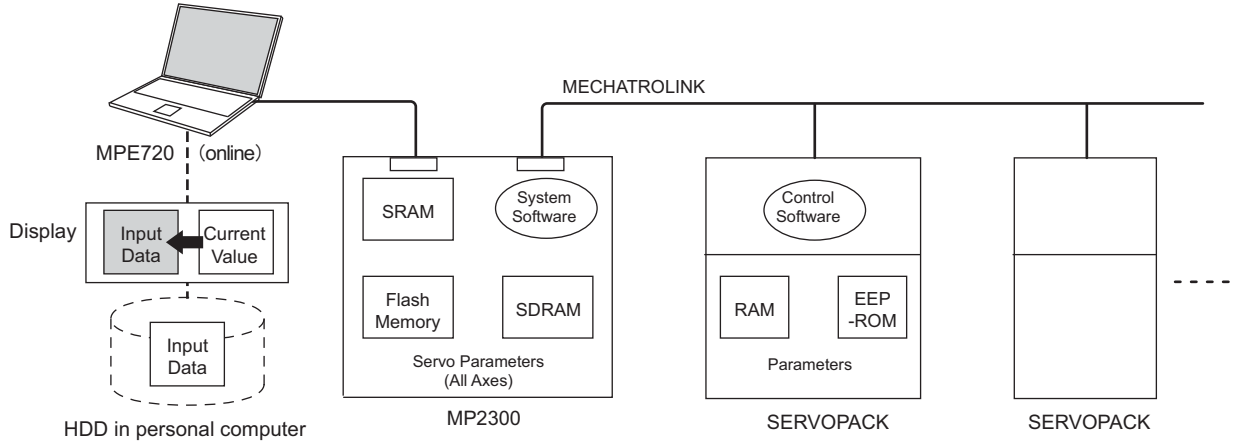

The following figure shows a display example after having selected *Edit - Copy Current Value* on the **SERVOPACK** Tab Page in the **SVB Definition** Window. The values in *Current Value* are copied to *Input Data*.

Before copying

No.	Name	Input Data	Unit	Current
0000	Function Selection Basic Switch 0	0000 H -		0000 H
0001	Function Selection Application Switch 1	0000 H -		0000 H
0002	Function Selection Application Switch 2	0111 H -		0111 H
0004	Function Selection Application Switch 4	0110 H -		0110 H
0006	Function Selection Application Switch 6	0002 H -		0002 H
0007	Function Selection Application Switch 7	0000 H -		0000 H
0008	Function Selection Application Switch 8	4000 H -		4000 H
0100	Speed Loop Gain	40.0 Hz		100.0
0101	Speed Loop Integral Time Constant	20.00 ms		40.00
0102	Position Loop Gain	40.0 /s		100.0
0103	Moment of Inertia Ratio/Mass ratio.	0 %		0
0104	2nd Speed Loop Gain	40.0 Hz		40.0

After copying

No.	Name	Input Data	Unit	Current
0000	Function Selection Basic Switch 0	0000 H -		0000 H
0001	Function Selection Application Switch 1	0000 H -		0000 H
0002	Function Selection Application Switch 2	0111 H -		0111 H
0004	Function Selection Application Switch 4	0110 H -		0110 H
0006	Function Selection Application Switch 6	0002 H -		0002 H
0007	Function Selection Application Switch 7	0000 H -		0000 H
0008	Function Selection Application Switch 8	4000 H -		4000 H
0100	Speed Loop Gain	100.0 Hz		100.0
0101	Speed Loop Integral Time Constant	40.00 ms		40.00
0102	Position Loop Gain	100.0 /s		100.0
0103	Moment of Inertia Ratio/Mass ratio.	0 %		0
0104	2nd Speed Loop Gain	40.0 Hz		40.0

(6) Changing Parameters in the SERVOPACK Tab Page

The data flow for SERVOPACK parameters is as follows when parameters for the cursor position are changed from the **SERVOPACK** Tab Page in the **SVB Definition** Window for MPE720:

- The MPE720 writes parameters of the relevant axis to the followings when the ENTER Key is pressed on the computer. (The parameters other than those of the relevant axis will not be written.)
 - *Input Data* (set data) on the **SERVOPACK** Tab Page
 - SDRAM of the MP2300
 - RAM of the SERVOPACK
- After having completed writing, the MPE720 updates the values in *Input Data* on the **SERVOPACK** Tab Page with the parameter values stored in the RAM of the SERVOPACK.

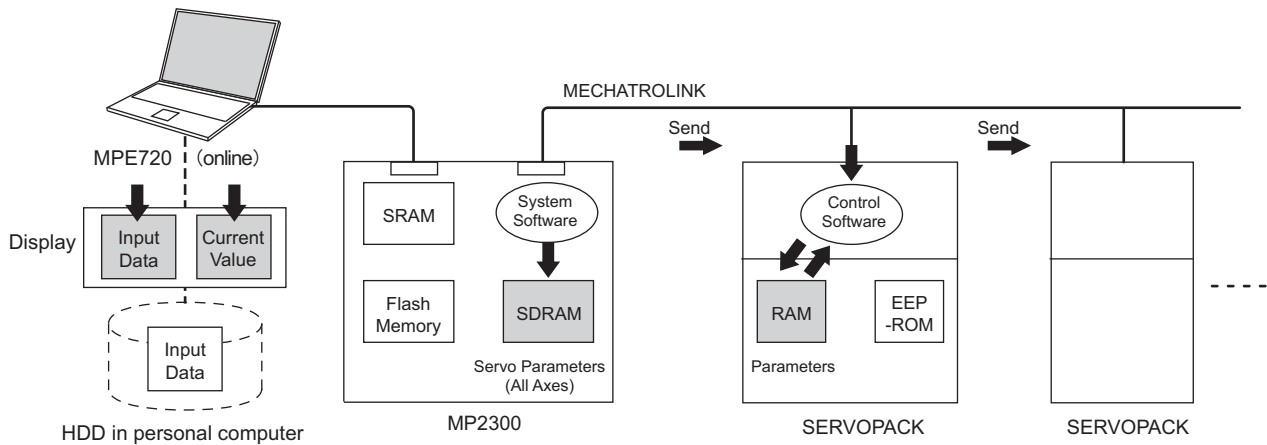

The following figure shows a display example after having changed the value (*2nd Speed Loop Gain*) in *Input Data* on the **SERVOPACK** Tab Page. After having pressed the ENTER Key, the values of *Speed Loop Gain*, *Speed Loop Integral Time Constant*, and *Position Loop Gain* (boxed in dotted line) in *Input Data* remain different from the values in *Current Value* since the parameters other than the one that has been changed are not written.

Before pressing ENTER Key

No.	Name	Input Data	Unit	Current
0000	Function Selection Basic Switch 0	0000	H -	0000
0001	Function Selection Application Switch 1	0000	H -	0000
0002	Function Selection Application Switch 2	0011	H -	0111
0004	Function Selection Application Switch 4	0110	H -	0110
0006	Function Selection Application Switch 6	0002	H -	0002
0007	Function Selection Application Switch 7	0000	H -	0000
0008	Function Selection Application Switch 8	4000	H -	4000
0100	Speed Loop Gain	40.0	Hz	100.0
0101	Speed Loop Integral Time Constant	20.00	ms	40.00
0102	Position Loop Gain	40.0	/s	100.0
0103	Moment of Inertia Ratio/Mass ratio.	0	%	0
0104	2nd Speed Loop Gain	100	Hz	40.0
0105	2nd Speed Loop Integral Time Constant	20.00	ms	20.00
0106	2nd Position Loop Gain	40.0	/s	40.0
0107	Bias	0	min-1	0

After having pressed ENTER Key

No.	Name	Input Data	Unit	Current
0000	Function Selection Basic Switch 0	0000	H -	0000
0001	Function Selection Application Switch 1	0000	H -	0000
0002	Function Selection Application Switch 2	0011	H -	0111
0004	Function Selection Application Switch 4	0110	H -	0110
0006	Function Selection Application Switch 6	0002	H -	0002
0007	Function Selection Application Switch 7	0000	H -	0000
0008	Function Selection Application Switch 8	4000	H -	4000
0100	Speed Loop Gain	40.0	Hz	100.0
0101	Speed Loop Integral Time Constant	20.00	ms	40.00
0102	Position Loop Gain	40.0	/s	100.0
0103	Moment of Inertia Ratio/Mass ratio.	0	%	0
0104	2nd Speed Loop Gain	100.0	Hz	100.0
0105	2nd Speed Loop Integral Time Constant	20.00	ms	20.00
0106	2nd Position Loop Gain	40.0	/s	40.0
0107	Bias	0	min-1	0

(7) Saving Data to Flash Memory

The data flow for SERVOPACK parameters is as follows when saving the parameters to flash memory on the MPE720:

- The MP2300 writes the parameters data (*Input Data*) held in SDRAM to flash memory.

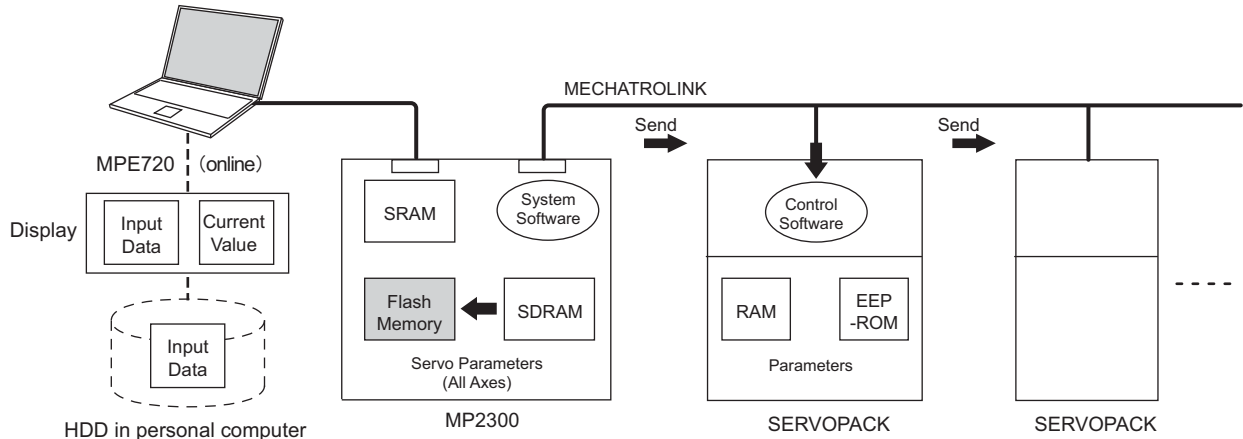

- Save to flash memory also after having changed set data of SERVOPACK parameter.

B.2 Precautions When Saving SERVOPACK Parameters

Before executing saving operation in the **SERVOPACK** Tab Page in any cases including the SERVOPACK replacement, always select **Edit - Copy Current Value** to copy the values in *Current Value* to *Input Data*.

C Initializing the Absolute Encoder

The procedure for initializing an absolute encoder for a Σ -I, Σ -II, Σ -III, or Σ -V SERVOPACK is given below.

- Refer to 9.2.1 *System Startup Flowchart* in the *Machine Controller MP2000 Series Built-in SVB/SVB-01 Motion Module User's Manual* (Manual No.: SIEPC88070033) for the procedure for absolute-position detection.

C.1 Initializing Procedures for Σ -V and Σ -III Series SERVOPACKs

- Refer to the following manual for information on Σ -V series SERVOPACKs: *Σ -V Series SGM□□/SGDV User's Manual Design and Maintenance* (Manual No.: SIEPS80000045).
- Refer to the following manuals for information on Σ -III series SERVOPACKs: *Σ -III Series SGM□□/SGDS User's Manual* (Manual No.: SIEPS80000000), *Σ -III Series SGM□□/SGDS User's Manual for MECHATROLINK-II Communications* (Manual No.: SIEPS80000011), and *Σ -III Series SGM□□/SGDS Digital Operator Instructions* (Manual No.: TOBPS80000001)

Follow the setup procedure below using a Digital Operator.

1. Press the  Key to display the Utility Function Mode main menu. Use the UP Key or DOWN Key to select Fn008.

```

BB          - F U N C T I O N -
Fn 0 0 7
Fn 0 0 8
Fn 0 0 9
Fn 0 0 A
  
```

2. Press the  Key.

The display is switched to the execution display of Fn008 (Absolute encoder multi-turn reset and encoder alarm reset).

```

BB
Multiturn Clear
PGCL1
  
```

- If the display is not switched and "NO_OP" is displayed in the status display, the Write Prohibited setting (Fn010 = 0001) is set. Check the status and reset. Then clear the Write Prohibited setting.

3. Keep pressing the  Key until "PGCL1" is changed to "PGCL5."

```

BB
Multiturn Clear
PGCL5
  
```

4. Press the  Key.

"BB" in the status display changes to "Done."

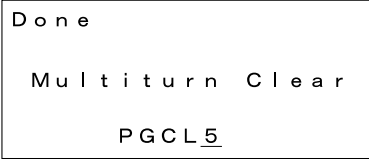

```
Done
Multiturn Clear
PGCL5
```

5. Press the  Key. The display returns to the Utility Function Mode main menu.

This completes setting up the absolute encoder. Turn the power supply OFF and then back ON to reset the SERVOPACK.

C.2 Σ-II SERVOPACK

- Refer to the following manuals for information on Σ-II SERVOPACKs.
Σ-II Series SGM□H/SGDH User's Manual (SIEPS80000005)
Σ-II Series SGM□/SGDB/SGM□H/SGDM User's Manual (SIEPS80000015)

(1) Initialization Using a Hand-held Digital Operator

1. Press the DSPL/SET Key to select the Auxiliary Function Mode.

A digital display showing the text "Fn000" in a seven-segment font.

2. Select parameter Fn008 by pressing the LEFT (<) and RIGHT (>) Keys to select the digit to be changed and then using the UP (∨) and DOWN (∧) Keys to change the value of the digit.

A digital display showing the text "Fn008" in a seven-segment font.

3. Press the DATA/ENTER Key.

The following display will appear.

A digital display showing the text "PGCL1" in a seven-segment font.

4. The rightmost digit will be incremented each time the UP (∨) Key is pressed. Press the UP (∨) Key several times until "PGCL5" is displayed.

If a mistake is made in the key operation, "nO_OP" will blink on the display for 1 second and then the display will return to the Auxiliary Function Mode. If this happens, return to step 3, above, and repeat the operation.

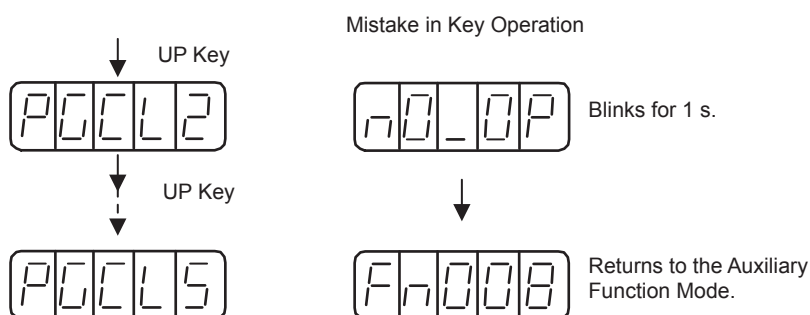

5. Press the DSPL/SET Key.

The display will change as shown below and the clear operation will be performed for multiturn data for the absolute encoder.

A diagram showing a digital display with the text "done" in a seven-segment font. An arrow labeled "Blinks for 1 s." points to another digital display showing the text "PGCL5" in a seven-segment font.

This completes initializing the absolute encoder. Reset the SERVOPACK to turn the power supply OFF and then back ON.

(2) Initialization Using the Built-in Panel Operator

1. Press the MODE/SET Key to select the Auxiliary Function Mode.



2. Press the UP (▲) and DOWN (▼) Keys to select parameter Fn008.



3. Press the DATA/ENTER Key for more than one second.

The following display will appear.

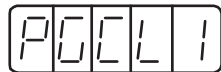

4. The rightmost digit will be incremented each time the UP (▲) Key is pressed. Press the UP (▲) Key several time until "PGCL5" is displayed.

If a mistake is made in the key operation, "nO_OP" will blink on the display for 1 second and then the display will return to the Auxiliary Function Mode. If this happens, return to step 3, above, and repeat the operation.

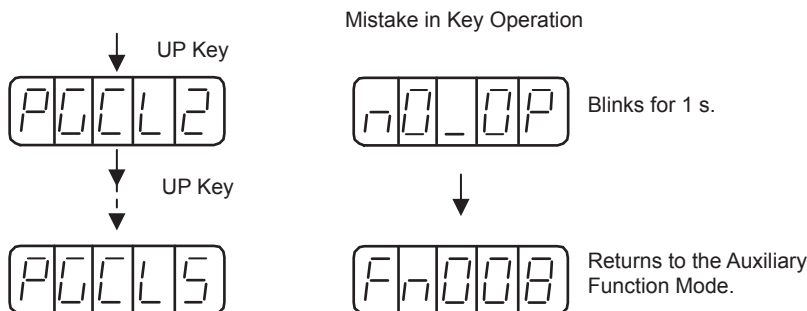

5. Press the MODE/SET Key.

The display will change as shown below and the clear operation will be performed for multiturn data for the absolute encoder.

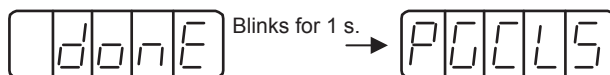

This completes initializing the absolute encoder. Reset the SERVOPACK to turn the power supply OFF and then back ON.

C.3 Σ -I SERVOPACK

- Refer to the following manuals for information on Σ -I SERVOPACKS.
 Σ Series SGM \square /SGD User's Manual (Manual No.:SIE-S800-26.3)
 Σ Series SGM \square /SGDB High-speed Field Network MECHATROLINK-compatible AC Servo Driver User's Manual (Manual No.: SIE-S800-26.4)

(1) Initializing a 12-bit Absolute Encoder

Use the following procedure to initialize a 12-bit absolute encoder.

1. Properly connect the SERVOPACK, Servomotor, and MP2300.
2. Disconnect the connector on the encoder end and short-circuit pins 13 and 14 on the encoder end connector for 2 seconds or more.

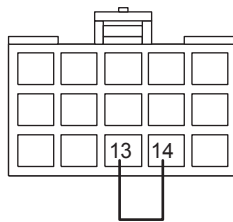

3. Remove the short piece and insert the connector securely in its original position.
4. Connect the cables using normal wiring and make sure the encoder battery is connected.
5. Turn ON the system.

Repeat the procedure starting from step 1 if an Absolute Encoder Alarm occurs, so the system has been successfully initialized.

(2) Initializing a 15-bit Absolute Encoder

Use the following procedure to initialize a 15-bit absolute encoder.

1. Turn OFF the SERVOPACK and MP2300.
2. Discharge the large-capacity capacitor in the encoder using one of the following methods.

■ At the SERVOPACK End Connector

- 1) Disconnect the connector on the SERVOPACK end.
- 2) Use a short piece to short-circuit together connector pins 10 and 13 on the encoder end and leave the pins short-circuited for at least 2 minutes.
- 3) Remove the short piece and insert the connector securely in its original position.

■ At the Encoder End Connector

- 1) Disconnect the connector on the encoder end.
- 2) Use a short piece to short-circuit together connector pins R and S on the encoder end and leave the pins short-circuited for at least 2 minutes.
- 3) Remove the short piece and insert the connector securely in its original position.

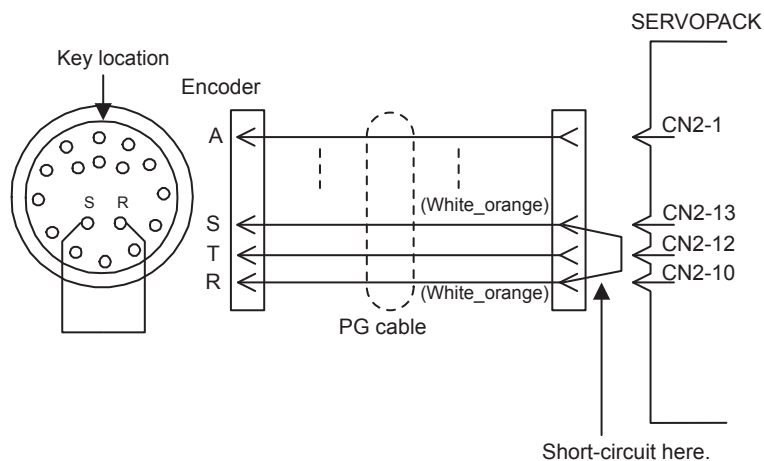

3. Connect the cables using normal wiring and make sure the encoder battery is connected.
4. Turn ON the system.

Repeat the procedure starting from step 1 if an Absolute Encoder Alarm occurs, so the system has been successfully initialized.

D Motion Parameter Lists

The motion parameters (fixed parameters, setting parameters, and monitoring parameters) for SVB and SVR Modules are listed below.

For information on how to use each motion parameter, refer to *Machine Controller MP2000 Series Built-in SVB/SVB-01 Motion Modules User's Manual* (Manual No.: SIEPC88070033).

- The Yes in the SVB or SVR column indicates that the motion parameter is supported by the corresponding module.
- The parameters whose register numbers are marked with an asterisk (*) are valid only when using an MP2300CPU Ver 2.61 or later and Σ -V series servo drive.

D.1 Fixed Parameter List

No.	Name	Contents	SVB	SVR
0	Selection of Operation Modes	0: Normal Operation Mode	Yes	Yes
		1: Axis unused	Yes	Yes
		2: Simulation mode	Yes	
		3: Servo Driver Transmission Reference Mode	Yes	
		4 and 5: Reserved for system use.	–	–
1	Function Selection Flag 1	Bit 0: Axis Selection (0: Finite length axis/1: Infinite length axis) • Set to 0 for linear type.	Yes	Yes
		Bit 1: Soft Limit (Positive Direction) Enable/Disable (0: Disabled/1: Enabled)	Yes	
		Bit 2: Soft Limit (Negative Direction) Enable/Disable (0: Disabled/1: Enabled)	Yes	
		Bit 3: Overtravel Positive Direction Enable/Disable (0: Disabled/1: Enabled)	Yes	
		Bit 4: Overtravel Negative Direction Enable/Disable (0: Disabled/1: Enabled)	Yes	
		Bits 5 to 7: Reserved for system use.	–	–
		Bit 8: Interpolation Segment Distribution Processing	Yes	
		Bit 9: Simple ABS Rotary Pos. Mode (Simple absolute infinite axis position control) (0: Disabled/1: Enabled) • Set to 0 for linear type.	Yes	
		Bit A: User Constants Self-writing Function	Yes	
		Bits B to F: Reserved for system use.		
2	Function Selection Flag 2	Bit 0: Communication Abnormality Detection Mask	Yes	
		Bit 1: WDT Abnormality Detection Mask	Yes	
		Bits 2 to F: Reserved for system use.	–	–
3	–	Reserved for system use.	–	–
4	Reference Unit Selection	0: pulse 3: inch 1: mm 4: μ m 2: deg • For linear type, 0 (pulse), 1 (mm), and 4 (μ m) can be used. If 2 (deg.) or 3 (inch) is selected, the selected unit will be converted to mm.	Yes	Yes
5	Number of Digits below Decimal Point	1 = 1 digit	Yes	Yes
6	Travel Distance per Machine Rotation (rotary motor)	1 = 1 reference unit	Yes	Yes
	Linear Scale Pitch (linear motor)	1 = 1 reference unit	Yes	Yes
8	Servo Motor Gear Ratio	1 = 1 rotation • Invalid for linear type	Yes	Yes
9	Machine Gear Ratio	1 = 1 rotation • Invalid for linear type	Yes	Yes

(cont'd)

No.	Name	Contents	SVB	SVR
10	Infinite Length Axis Reset Position (POSMAX)	1 = 1 reference unit • Invalid for linear type	Yes	Yes
12	Positive Software Limit Value	1 = 1 reference unit	Yes	
14	Negative Software Limit Value	1 = 1 reference unit	Yes	
16	Backlash Compensation Amount	1 = 1 reference unit	Yes	
18 to 29	–	Reserved for system use.	–	–
30	Encoder Selection	0: Incremental encoder 1: Absolute encoder 2: Absolute encoder (Incremental encoder is used.) 3: Reserved (External encoder)	Yes	
31 to 33	–	Reserved for system use.	–	–
34	Rated Motor Speed (Rotary Motor)	1 = 1 min ⁻¹	Yes	Yes
	Rated Speed (Linear Motor)	1 = 0.1 m/s, 0.1 mm/s	Yes	Yes
36	Number of Pulses per Motor Rotation (Rotary Motor)	1 = 1 pulse/rev Set the value after multiplication.	Yes	Yes
	Number of Pulses per Linear Scale Pitch (Linear Motor)	1 = 1 pulse/scale pitch	Yes	Yes
38	Maximum Number of Absolute Encoder Turns Rotation	1 = 1 rotation • Set to 0 when a direct drive motor is being used. • Invalid for linear type	Yes	
40 to 41	–	Reserved for system use.	–	–
42	Feedback Speed Movement Averaging Time Constant	1 = 1 ms	Yes	Yes

D.2 Setting Parameter List

Register No.	Name	Contents	SVB	SVR
0W□□00	RUN Command Setting	Bit 0: Servo ON (0: OFF/1: ON)	Yes	Yes
		Bit 1: Machine Lock (0: Normal Operation/1: Machine Lock)	Yes	
		Bits 2 to 3: Reserved for system use		
		Bit 4: Latch Detection Demand (0: OFF/1: ON)	Yes	
		Bit 5: Reserved for system use		
		Bit 6: POSMAX Turn Number Presetting Demand (0: OFF/1: ON)	Yes	Yes
		Bit 7: Request ABS Rotary Pos. Load (Absolute system infinite length position information LOAD) (0: OFF/1: ON) • Set to 0 for linear type	Yes	
		Bit 8: Forward Outside Limiting Torque/Thrust Input (Forward external torque/thrust input) (0: OFF/1: ON)	Yes	
		Bit 9: Reverse Outside Limiting Torque/Thrust Input (Forward external torque/thrust input) (0: OFF/1: ON)	Yes	
		Bit A: Reserved for system use		
		Bit B: Integration Reset (0: OFF/1: ON)	Yes	
		Bit C: Reserved for system use		
		Bit D: Latch completion status clear request	Yes	
		Bit E: Communication Reset (0: OFF/1: ON)	Yes	
Bit F: Alarm Clear	Yes	Yes		

(cont'd)

Register No.	Name	Contents	SVB	SVR
OW□□01	Mode Setting 1	Bit 0: Excessive Deviation Error Level Setting (0: Alarm/1: Warning)	Yes	
		Bits 1 to 2: Reserved for system use.		
		Bit 3: Speed Loop P/PI Switch	Yes	
		Bit 4: Gain Switch	Yes	
		Bit5: Gain Switch 2	Yes	
		Bit6: Latch mode selection (0: Usual latch/1: Continuous latch)	Yes	
		Bits 7 to F: Reserved for system use.		
OW□□02	Mode Setting 2	Bit 0: Monitor 2 Enabled (0: Disabled/1: Enabled)	Yes	
		Bits 1 to F: Reserved for system use.		
OW□□03	Function Setting 1	Bits 0 to 3: Speed Unit Selection 0: Reference unit/s 1: 10 ⁿ reference unit/min 2: Percentage of rated speed (1 = 0.01%) 3: Percentage of rated speed (1 = 0.0001%)	Yes	Yes
		Bits 4 to 7: Acceleration/Deceleration Degree Unit Selection 0: Reference unit/s ² 1: ms	Yes	Yes
		Bits 8 to B: Filter Type Selection 0: No filter 1: Exponential acceleration/deceleration filter 2: Moving average filter	Yes	Yes
		Bits C to F: Torque Unit Selection 0: Percentage of rated toque (1 = 0.01%) 1: Percentage of rated toque (1 = 0.0001%)	Yes	Yes
OW□□04	Function Setting 2	Bits 0 to 3: Latch Detection Signal Selection		
		0: -		
		1: -		
		2: Phase-C pulse input signal	Yes	
		3: /EXT1	Yes	
		4: /EXT2	Yes	
		5: /EXT3	Yes	
		Bits 4 to 7: External Positioning Signal Setting		
		0: -		
		1: -		
		2: Phase-C pulse input signal	Yes	
		3: /EXT1	Yes	
		4: /EXT2	Yes	
		5: /EXT3	Yes	
Bits 8 to B: Reserved for system use.				
Bits C to F: Bank Selector	Yes			
OW□□05	Function Setting 3	Bit 1: Phase Reference Creation Calculation Disable (0: Enabled/1: Disabled)	Yes	
		Bits 2 to A: Reserved for system use.		
		Bit B: Zero Point Return Input Signal (0: OFF/1: ON)	Yes	
		Bits C to F: Reserved for system use.		
OW□□06 to OW□□07	-	Reserved for system use.	-	-

(cont'd)

Register No.	Name	Contents	SVB	SVR
OW□□08	Motion Command	0: NOP (No Command) 1: POSING (Position Mode) (Positioning) 2: EX_POSING (Latch Target Positioning) (External positioning) 3: ZRET (Zero Point Return) 4: INTERPOLATE (Interpolation) 5: ENDOF_INTERPOLATE (Last Interpolation Segment) (Reserved for the system) 6: LATCH (Interpolation Mode with Latch Input) 7: FEED (Jog Mode) 8: STEP (Relative Position Mode) (Step mode) 9: ZSET (Set Zero Point) 10: ACC (Change Acceleration Time) 11: DCC (Change Deceleration Time) 12: SCC (Change Filter Time Constant) 13: CHG_FILTER (Change Filter Type) 14: KVS (Change Speed Loop Gain) 15: KPS (Change Position Loop Gain) 16: KFS (Change Feed-forward) 17: PRM_RD (Read User Constant) (Read SERVOPACK parameter) 18: PRM_WR (Write User Constant) (Write SERVOPACK parameter) 19: ALM_MON (Alarm Monitor) 20: ALM_HIST (Alarm History Monitor) 21: ALMHIST_CLR (Clear Alarm History) 22: ABS_RST (Absolute Encoder Reset) 23: VELO (Speed Reference) 24: TRQ (Torque/Thrust Reference) 25: PHASE (Phase Reference) 26: KIS (Change Position Loop Integral Time Constant) 27: PPRM_WR (Stored Parameter Write)	Yes	Yes
OW□□09	Motion Command Control Flag	Bit 0: Holds a Command (0: OFF/1: ON)	Yes	Yes
		Bit 1: Interrupt a Command (0: OFF/1: ON)	Yes	Yes
		Bit 2: Moving Direction (JOG/STEP) (0: Forward rotation/1: Reverse rotation)	Yes	Yes
		Bit 3: Zero point Direction Selection (0: Reverse rotation/1: Forward rotation)	Yes	
		Bit 4: Latch Zone Effective Selection (0: Disabled/1: Enabled)	Yes	
		Bit 5: Position Reference Type (0: Incremental Addition Mode/1: Absolute Mode)	Yes	Yes
		Bit 6: Phase Compensation Type (0: Incremental Addition Mode/1: Absolute Mode)	Yes	
		Bits 7 to F: Reserved for system use.		
OW□□0A	Motion Subcommand	0: NOP (No command)	Yes	Yes
		1: PRM_RD (Read User Constant) (Read SERVOPACK parameter)	Yes	
		2: PRM_WR (User Constant) (Write SERVOPACK parameter)		
		3: Reserved 4: SMON (Status monitor)		
		5: FIXPRM_RD (Read Fixed Parameters)	Yes	Yes
OW□□0B	–	Reserved for system use.		
OL□□0C	Torque/Thrust Reference Setting	Unit is according to OW□□03, bits 12 to 15 (Torque Unit Setting).	Yes	Yes
OW□□0E	Speed Limit Setting at the Torque/Thrust Reference	1 = 0.01% (percentage of rated speed)	Yes	
OW□□0F	–	Reserved for system use.		
OL□□10	Speed Reference Setting	Unit is according to OW□□03, bits 0 to 3 (Speed Unit Selection).	Yes	Yes

(cont'd)

Register No.	Name	Contents	SVB	SVR
OW□□12 to OW□□13	–	Reserved for system use.	–	–
OL□□14	Positive Side Limiting Torque/Thrust Setting at the Speed Reference	Unit is according to OW□□03, bits C to F (Torque Unit).	Yes	
OL□□16	Secondly Speed Compensation	Unit is according to OW□□03, bits 0 to 3 (Speed Unit Selection).	Yes	Yes
OW□□18	Override	1 = 0.01%	Yes	
OW□□19 to OW□□1B	–	Reserved for system use.	–	–
OL□□1C	Position Reference Setting	1 = 1 reference unit	Yes	Yes
OL□□1E	Width of Positioning Completion	1 = 1 reference unit	Yes	
OL□□20	NEAR Signal Output Width	1 = 1 reference unit	Yes	
OL□□22	Error Count Alarm Detection	1 = 1 reference unit	Yes	
OL□□24	–	Reserved for system use.	–	–
OW□□26	Positioning Completion Check Time	1 = 1 ms	Yes	
OW□□27	–	Reserved for system use.		
OL□□28	Phase Correction Setting	1 = 1 reference unit	Yes	
OL□□2A	Latch Zone Lower Limit Setting	1 = 1 reference unit	Yes	
OL□□2C	Latch Zone Upper Limit Setting	1 = 1 reference unit	Yes	
OW□□2E	Position Loop Gain	1 = 0.1/s	Yes	
OW□□2F	Speed Loop Gain	1 = 1 Hz	Yes	
OW□□30	Speed Feedforward Amends	1 = 0.01% (percentage of distribution segment)	Yes	
OW□□31	Speed Compensation	1 = 0.01% (percentage of rated speed)	Yes	Yes
OW□□32	Position Integration Time Constant	1 = 1 ms	Yes	
OW□□33	–	Reserved for system use.	–	–
OW□□34	Speed Integration Time Constant	1 = 0.01 ms	Yes	
OW□□35	–	Reserved for system use.	–	–
OL□□36	Straight Line Acceleration/ Acceleration Time Constant	Units depends on the setting of OW□□03, bits 4 to 7 (Acceleration/ Deceleration Degree Unit Selection).	Yes	Yes
OL□□38	Straight Line Deceleration/ Deceleration Time Constant	Units depends on the setting of OW□□03, bits 4 to 7 (Acceleration/ Deceleration Degree Unit Selection).	Yes	Yes
OW□□3A	Filter Time Constant	1 = 0.1 ms	Yes	Yes
OW□□3B	Bias Speed for Exponential Acceleration/ Deceleration Filter	Unit is according to OW□□03, bits 0 to 3 (Speed Unit Selection).		Yes

(cont'd)

Register No.	Name	Contents	SVB	SVR
OW□□3C	Zero Point Return Method	0: DEC1 + C (DEC1 and C-Phase) 1: ZERO (Zero signal) 2: DEC1 + ZERO (DEC1 and ZERO Signal) 3: C (C-pulse)	Yes	
		4 to 10: Reserved for system use.	–	–
		11: C Pulse Only 12: POT & C Pulse 13: POT Only 14: HOME LS & C Pulse 15: HOME Only	Yes	
		16: NOT & C Pulse 17: NOT Only 18: INPUT & C Pulse 19: INPUT Only	Yes	
OW□□3D	Width of Starting Point Position Output	1 = 1 reference unit	Yes	Yes
OL□□3E	Approach Speed	Unit is according to OW□□03, bits 0 to 3 (Speed Unit Selection).	Yes	
OL□□40	Creep Rate	Unit is according to OW□□03, bits 0 to 3 (Speed Unit Selection).	Yes	
OL□□42	Zero Point Return Travel Distance	1 = 1 reference unit	Yes	
OL□□44	Step Travel Distance	1 = 1 reference unit	Yes	Yes
OL□□46	External Positioning Final Travel Distance	1 = 1 reference unit	Yes	
OL□□48	Zero Point Position in Machine Coordinate Offset	1 = 1 reference unit	Yes	Yes
OL□□4A	Work Coordinate System Offset	1 = 1 reference unit	Yes	Yes
OL□□4C	Number of POSMAX Turns Presetting Data	1 = 1 reference unit • Invalid for liner type	Yes	Yes
OW□□4E	Servo User Monitor Setting	Bits 0 to 3: Monitor 1 (Cannot be set.) Bits 4 to 7: Monitor 2 Bits 8 to B: Monitor 3 (Cannot be set.) Bits C to F: Monitor 4	Yes	
OW□□4F	Servo Driver Alarm Monitor No.	Set the number of the alarm to monitor.	Yes	
OW□□50	Servo Driver User Constant No. (SERVOPACK parameter No. for motion command)	Set the number of the SERVOPACK parameter.	Yes	
OW□□51	Servo Driver User Constant Size (SERVOPACK parameter size for motion command)	Set the number of words in the SERVOPACK parameter.	Yes	
OL□□52	Servo Driver User Constant Set Point (SERVOPACK parameter setting value for motion command)	Set the setting for the SERVOPACK parameter.	Yes	

(cont'd)

Register No.	Name	Contents	SVB	SVR
OW□□54	Servo Driver for Assistance User Constant No. (SERVOPACK parameter No. for motion subcommand)	Set the number of the SERVOPACK parameter number.	Yes	
OW□□55	Servo Driver for Assistance User Constant Size (SERVOPACK parameter size for motion subcommand)	Set the number of words in the SERVOPACK parameter.	Yes	
OL□□56	Servo Driver for Assistance User Constant Set Point (SERVOPACK parameter setting value for motion subcommand)	Set the setting for the SERVOPACK parameter.	Yes	
OW□□58 to OW□□5B	–	Reserved for system use.	–	–
OW□□5C	Fixed Parameter Number	Set the number of the fixed parameter to read with the FIXPRM_RD motion subcommand.	Yes	Yes
OW□□5D	–	Reserved for system use.	–	–
OL□□5E	Encoder Position When Power is OFF (Lower 2 words)	1 = 1 pulse ♦ For linear type, do not set this register.	Yes	
OL□□60	Encoder Position When Power is OFF (Upper 2 words)	1 = 1 pulse ♦ For linear type, do not set this register.	Yes	
OL□□62	Pulse Position When Power is OFF (Lower 2 words)	1 = 1 pulse ♦ For linear type, do not set this register.	Yes	
OL□□64	Pulse Position When Power is OFF (Upper 2 words)	1 = 1 pulse ♦ For linear type, do not set this register.	Yes	
OL□□66 to OL□□6E	–	Reserved for system use.	–	–
OW□□70 to OW□□7F	Command Buffer for Servo Driver Transmission Reference Mode	This area is used for command data when MECHATROLINK servo commands are specified directly.	Yes	

D.3 Monitoring Parameter List

Register No.	Name	Contents	SVB	SVR
IW□□00	RUN Status	Bit 0 Motion Controller Operation Ready	Yes	Yes
		Bit 1: Running (At Servo ON)	Yes	Yes
		Bit 2: System BUSY	Yes	
		Bit 3: Servo Ready	Yes	
		Bit 4: Latch Mode	Yes	
		Bits 5 to F: Reserved for system use.	–	–
IW□□01	Parameter Number When Range Over is Generated	Setting parameters: 0 or higher Fixed Parameters: 1000 or higher	Yes	Yes

(cont'd)

Register No.	Name	Contents	SVB	SVR
IL□□02	Warning	Bit 0: Excessive Deviation	Yes	
		Bit 1: Set Parameter Error (Setting parameter error)	Yes	Yes
		Bit 2: Fixed Parameter Error	Yes	Yes
		Bit 3: Servo Driver Error	Yes	
		Bit 4: Motion Command Set Error	Yes	Yes
		Bit 5: Reserved for system use.	–	–
		Bit 6: Positive Direction Overtravel	Yes	
		Bit 7: Negative Direction Overtravel	Yes	
		Bit 8: Servo ON Incomplete	Yes	
		Bit 9: Servo Driver Communication Warning	Yes	
		Bit A: Servo Driver Stop Signal Input	Yes	
Bits B to 1F: Reserved for system use.				
IL□□04	Alarm	Bit 0: Servo Driver Error	Yes	
		Bit 1: Positive Direction Overtravel	Yes	
		Bit 2: Negative Direction Overtravel	Yes	
		Bit 3: Positive Direction Software Limit	Yes	
		Bit 4: Negative Direction Software Limit	Yes	
		Bit 5: Servo OFF	Yes	Yes
		Bit 6: Positioning Time Over	Yes	
		Bit 7: Excessive Positioning Moving Amount	Yes	
		Bit 8: Excessive Speed	Yes	
		Bit 9: Excessive Deviation	Yes	
		Bit A: Filter Type Change Error	Yes	
		Bit B: Filter Time Constant Change Error	Yes	
		Bit C: Reserved for system use.	–	–
		Bit D: Zero Point Unsetting ♦ Invalid for linear type.	Yes	
		Bit E: Reserved for system use.	Yes	
		Bit F: Reserved for system use.	Yes	
		Bit 10: Servo Driver Synchronization Communications Error	Yes	
		Bit 11: Servo Driver Communication Error	Yes	
Bit 12: Servo Driver Command Timeout Error	Yes			
Bit 13: Excessive ABS Encoder Rotations ♦ Invalid for linear type	Yes			
Bits 14 to 1D: Reserved for system use.	–	–		
Bit 1E: Motor Type Set Error	Yes	–		
Bit 1F: Connected Encoder Type Error	Yes	–		
IL□□06	–	Reserved for system use.	–	–
IW□□08	Motion Command Response Code	Same as OW□□08 (Motion Command).	Yes	Yes
IW□□09	Motion Command Status	Bit 0: Command Execution Flag	Yes	Yes
		Bit 1: Command Hold Completed (HOLDL)	Yes	Yes
		Bit 2: Reserved for system use.		
		Bit 3: Command Error Completed Status (FAIL) (Command Encoder Type Error)	Yes	Yes
		Bits 4 to 6: Reserved for system use.	–	–
		Bit 7: Reset Absolute Encoder Completed	Yes	
		Bit 8: Command Execution Completed (COMPLETE)	Yes	Yes
Bits 9 to F: Reserved for system use.	–	–		
IW□□0A	Motion Subcommand Response Code	Same as OW□□0A (Motion Subcommand).	Yes	Yes

(cont'd)

Register No.	Name	Contents	SVB	SVR
IW□□0B	Subcommand Status	Bit 0: Command Executing Flag	Yes	Yes
		Bits 1 to 2: Reserved for system use.	–	–
		Bit 3: Command Error Completed Status (Command Error Occurrence)	Yes	Yes
		Bits 4 to 7: Reserved for system use.	–	–
		Bit 8: Command Execution Completed	Yes	Yes
		Bits 9 to F: Reserved for system use.	–	–
IW□□0C	Position Management Status	Bit 0: Discharging Completed (DEN)	Yes	Yes
		Bit 1: Positioning Completed (POSCOMP)	Yes	Yes
		Bit 2: Latch Complete (LCOMP)	Yes	
		Bit 3: NEAR Position (NEAR)	Yes	Yes
		Bit 4: Zero Point Position (ZERO)	Yes	Yes
		Bit 5: Zero Point Return (Setting) Completed (ZRNC)	Yes	Yes
		Bit 6: During Machine Lock (MLKL)	Yes	
		Bit 7: Reserved for system use.	–	–
		Bit 8: ABS Rotary Pos. LOAD Complete (ABS System Infinite Length Position Control Information Load Completed) (ABSLDE) ♦ Invalid for linear type	Yes	
		Bit 9: POSMAX Turn Preset Complete (TPRSE) ♦ Invalid for linear type	Yes	Yes
Bits A to F: Reserved for system use.				
IW□□0D	–	Reserved for system use.	–	–
IL□□0E	Target Position in Machine Coordinate System (TPOS)	1 = 1 reference unit	Yes	Yes
IL□□10	Calculated Position in Machine Coordinate System (CPOS)	1 = 1 reference unit	Yes	Yes
IL□□12	Machine Coordinate System Reference Position (MPOS)	1 = 1 reference unit	Yes	Yes
IL□□14	CPOS for 32 bit	1 = 1 reference unit	Yes	Yes
IL□□16	Machine Coordinate System Feedback Position (APOS)	1 = 1 reference unit	Yes	Yes
IL□□18	Machine Coordinate System Latch Position (LPOS)	1 = 1 reference unit	Yes	
IL□□1A	Position Error (PERR)	1 = 1 reference unit	Yes	
IL□□1C	Target Position Difference Monitor	1 = 1 reference unit		Yes
IL□□1E	Number of POSMAX Turns	1 = 1 turn ♦ Invalid for linear type	Yes	Yes
IL□□20	Speed Reference Output Monitor	pulse/s	Yes	
IL□□22 to IL□□2A	–	Reserved for system use.	–	–

(cont'd)

Register No.	Name	Contents	SVB	SVR
IW□□2C	Servo Driver Status	Bit 0: ALM (Alarm) Bit 1: WARN (Warning) Bit 2: CMDRY (Command Ready) Bit 3: SVON (Servo ON) Bit 4: PON (Main Power Supply ON) Bit 5: MLOCK (Machine Lock) Bit 6: ZPOINT (Zero Position) Bit 7: PSET (Locating Complete) (Positioning completed/V-CMP (Speed Coincidence)) Bit 8: DEN (Commanded Profile Complete) (Distribution completed)/SZPD (Zero Speed) Bit 9: T_LIM (Torque Restriction) Bit A: L_CMP (Latch Complete) Bit B: NEAR (Locating Neighborhood) (NEAR Position)/V_LIM (Speed Limit) Bit C: P_SOT (Position Software Limit) Bit D: N_SOT (Negative Software Limit) Bits E and F: Reserved for system use	Yes	
IW□□2D	Servo Driver Alarm Code	Stores the alarm code from the SERVOPACK.	Yes	
IW□□2E	Servo Driver I/O Monitor	Bit 0: Forward Side Limit Switch Input Bit 1: Reverse Side Limit Switch Input Bit 2: Deceleration Dog Switch Input Bit 3: Encoder Phase-A Signal Input Bit 4: Encoder Phase-B Signal Input Bit 5: Encoder Phase-C Signal Input Bit 6: EXT1 Signal Input Bit 7: EXT2 Signal Input Bit 8: EXT3 Signal Input Bit 9: Brake State Output Bit A: Stop signal (HWBB) Bit B: Reserved for system use Bits C to F: For SGD+NS115, SGDS, and SGDV SERVOPACKs: CN1 input signals (IO12 to IO15) For other SERVOPACK models: Reserved by system	Yes	
IW□□2F	Servo Driver User Monitor Information	Bits 0 to 3: Monitor 1 Bits 4 to 7: Monitor 2 Bits 8 to B: Monitor 3 Bits C to F: Monitor 4	Yes	
IL□□30	Servo Driver User Monitor 2	Stores the result of the selected monitor.	Yes	
IL□□32	Servo Driver User Monitor 3	Reserved for system use.		
IL□□34	Servo Driver User Monitor 4	Stores the result of the selected monitor.	Yes	
IW□□36	Servo Driver User Constant No.	Stores the number of the parameter being processed.	Yes	
IW□□37	Supplementary Servo Driver User Constant No.	Stores the number of the parameter being processed.	Yes	
IL□□38	Servo Driver User Constant Reading Data	Stores the data of the parameter being read.	Yes	
IL□□3A	Supplementary Servo Driver User Constant Reading Data	Stores the data of the parameter being read.	Yes	
IW□□3F	Motor Type	Stores the type of motor actually connected. 0: Rotation type motor 1: Linear motor	Yes	
IL□□40	Feedback Speed	Unit is according to OW□□03, bits 0 to 3 (Speed Unit Selection).	Yes	Yes

(cont'd)

Register No.	Name	Contents	SVB	SVR
IL□□42	Feedback Torque/ Thrust	Unit is according to OW□□03, bits 12 to 15 (Torque Unit Selection).	Yes	Yes
IL□□44	Latch Completion Sequence Number	1 = 1 time	Yes	
IL□□45	Number of Continuous Latch Sequence Completion Cycles	–	Yes	
IW□□46 to IW□□55	–	Reserved for system use.	–	–
IL□□56	Fixed Parameter Monitor	Stores the data of the fixed parameter when FIXPRM_RD has been specified in the Motion Subcommand.	Yes	Yes
IW□□58 to IW□□5C	–	Reserved for system use.	–	–
IL□□5E	Encoder Position When the Power is OFF (Lower 2 words)	1 = 1 pulse	Yes	
IL□□60	Encoder Position When the Power is OFF (Upper 2 words)	1 = 1 pulse	Yes	
IL□□62	Pulse Position When the Power is OFF (Lower 2 Words)	1 = 1 pulse	Yes	
IL□□64	Pulse Position When the Power is OFF (Upper 2 Words)	1 = 1 pulse	Yes	
IW□□66 to IW□□6F	–	Reserved for system use.	–	–
IW□□70 to IW□□7F	Response Buffer for Servo Driver Transmission Reference Mode	Stores the response data when MECHATROLINK Servo commands are specified directly.	Yes	

INDEX

Symbols

****I/O -----2-21
 ****SERVO -----2-21

A

ABS (absolute) encoder count exceeded -----6-35
 accessories -----1-9
 alarm IL□□04 list -----6-31
 all program file dump -----4-41
 all-in-one -----2-7
 Assembling the 24-VDC Power Supply Cable -----3-11
 axis alarm -----6-31

B

basic module -----2-7
 appearance -----1-3, 3-2
 connectors -----3-9
 CPU I/O connector -----3-16
 power supply connector -----3-10
 Battery -----1-9
 battery
 life -----6-4
 Built-in SVB -----2-25

C

Cables -----1-8
 causes for command error occurrence -----6-26
 child drawings -----5-6
 combination of modules -----1-4
 communication settings -----4-6
 CPU I/O (Built-in I/O) Module -----2-11

D

daily inspections -----6-2
 data types -----5-24
 definition data
 self-configuration -----5-36
 details on I/O error status -----6-20
 digital operator -----4-5
 DIN Rail -----1-9
 DIN rail mounting -----3-3
 DIN rail mounting clips -----3-4
 DIP Switch Settings -----5-2
 drawing execution control -----5-7
 drawing types -----5-6
 DWG registers -----5-21

E

electronic cam -----4-62
 electronic shaft -----4-58
 error confirmation flow -----6-6
 error status -----6-14
 excessive positioning moving amount -----6-33
 excessive speed -----6-33
 excessively following error -----6-33

F

filter time constant change error -----6-34
 filter type change error -----6-33
 fixed parameter list -----A-19

function registers -----5-22
 functions -----5-6, 5-20

G

grandchild drawings -----5-6
 group folders -----4-25
 creating -----4-25
 groups -----5-11

H

H drawing -----4-49
 H01 drawing -----4-49
 H02 drawing -----4-50
 H02.01 drawing -----4-51
 H02.02 drawing -----4-52
 H06.01 drawing -----4-60
 H06.02 drawing -----4-64
 hardware specifications
 Basic Module -----2-2
 MP2300 -----2-3
 How to Open the Tuning Panel Window -----4-44

I

I/O map tab -----2-22
 input circuits
 CPU I/O connector -----3-17
 interpolation override -----5-14

L

L drawing -----4-67
 L06 drawing -----4-67
 ladder drawings (DWG) -----5-6
 LED
 Basic Module -----2-8
 LED indicator details -----5-5
 LED indicators -----6-7
 link assignment tab page -----2-21
 loading
 individual -----4-34
 Local I/O definition Window -----2-11
 log off -----4-43

M

manual operation -----4-46
 MECHATROLINK
 cables -----3-12
 connector -----3-12
 SERVOPACKs -----1-7
 terminator connections -----3-14
 MECHATROLINK transmission definition -----2-17
 Module -----5-34
 Module Configuration Definitions -----2-9
 module information -----6-22
 monitoring parameter list -----A-25
 motion control function specifications -----2-5
 motion error details -----6-31
 motion errors -----6-30
 motion fixed parameter
 setting -----4-36
 motion program alarm codes -----6-24
 motion program alarms -----6-24
 Motion Program Control Signals -----5-13
 motion program execution information -----6-23

- motion programs ----- 4-53, 4-57, 5-10, 5-12
 - execution information ----- 5-15
 - ladder programs for control ----- 5-18
 - MSEE registers ----- 5-12
 - S registers ----- 5-12
 - status bits ----- 5-12
 - mounting MP2300 ----- 3-3
 - MP2500
 - mode switch 1 (S1) ----- 5-2
 - mode switch 2 (S2) ----- 5-2
 - MPE720 ----- 4-23
 - MPE720 (Embedded) startup ----- 4-23
- N**
- negative overtravel ----- 6-31
 - negative software limit ----- 6-32
- O**
- online logon ----- 4-28
 - operation
 - starting ----- 5-4
 - stopping ----- 5-4
 - operation errors
 - processing drawings ----- 5-6
 - option slot configuration ----- 2-7
 - Option Slot Cover ----- 1-9
 - optional modules ----- 3-6
 - appearance ----- 1-3
 - installing ----- 3-8
 - removing ----- 3-6
 - replacing and adding ----- 3-6
 - order folders ----- 4-26
 - output circuit
 - CPU I/O connector ----- 3-18
- P**
- parent drawings ----- 5-6
 - password ----- 4-31
 - pin arrangement
 - CPU I/O connector ----- 3-16
 - PLC folders ----- 4-27
 - creating ----- 4-27
 - PLC function specifications ----- 2-4
 - position control ----- 4-53
 - positioning time over ----- 6-32
 - positive overtravel ----- 6-31
 - positive software limit ----- 6-32
 - program memory
 - remaining capacity ----- A-4
 - programming device-related equipment ----- 4-4
- R**
- register types ----- 5-21
 - regular inspections ----- 6-3
- S**
- S registers
 - monitoring execution information ----- 5-15
 - sample programs
 - checking operation ----- 4-44
 - saving to flash memory ----- 4-40
 - scan execution status ----- A-4
 - scan processing drawing ----- 5-7
 - scan time
 - setting and changing ----- 5-40
 - Self-Configuration ----- 2-10
 - self-configuration ----- 4-28, 5-4, 5-28
 - method ----- 4-12
 - self-diagnosis
 - online ----- 5-4
 - self-diagnosis at startup ----- 5-4
 - servo driver command timeout error ----- 6-34
 - servo driver communication error ----- 6-34
 - servo driver error ----- 6-31
 - servo driver error codes ----- 6-36
 - servo driver synchronization communication error ----- 6-34
 - servo OFF ----- 6-32
 - SERVOPACK initialization ----- 4-5
 - SERVOPACK unmatched encoder type ----- 6-35
 - SERVOPACK unmatched motor type ----- 6-35
 - Setting and Saving Motion Fixed Parameters ----- 4-17
 - setting parameter list ----- A-20
 - Settings for CPU I/O Module ----- 2-11
 - Starting the Sample Program - MPE720 Ver 6.□□ ----- 4-13
 - startup sequence ----- 5-2
 - status tab page ----- 2-22
 - SVB definition ----- 2-23
 - switch
 - Basic Module ----- 2-8
 - synchronization between modules ----- 2-15
 - System Configuration ----- 4-3
 - system error status ----- 6-15
 - system I/O error status ----- 6-19
 - system program software number ----- A-4
 - system registers
 - accessing ----- 6-10
 - configuration ----- 6-14
 - system service registers ----- A-2
 - system services
 - execution status ----- 6-19
 - system startup ----- 4-2
 - adding electric devices ----- 4-71
 - first ----- 4-68
 - procedure ----- 4-2
 - replacing electric devices ----- 4-73
 - self-configuration ----- 4-68
 - system status ----- 6-14
 - system work number ----- 5-14
- T**
- transfer
 - all ----- 4-32
 - transmission parameters tab ----- 2-18
 - troubleshooting ----- 6-5
 - system errors ----- 6-9
 - Troubleshooting When ALM is Lit ----- 6-13
 - Troubleshooting When ERR is Lit ----- 6-12
- U**
- user definition files ----- 5-38
 - user name ----- 4-31
 - user operation
 - error status ----- 6-16
 - user programs ----- 5-6

V

virtual motion module
SVR -----2-26

W

wait for monitor data update -----2-20
wild card I/O -----2-21

Z

zero point not set -----6-34

Revision History

The revision dates and numbers of the revised manuals are given on the bottom of the back cover.

MANUAL NO. SIEP C880700 03B

Published in Japan February 2005 03-4 \diamond -1

└─ Date of publication
└─ Date of original publication
└─ Revision number
└─ WEB revision number

Date of Publication	Rev. No.	WEB Rev. No.	Section	Revised Contents
July 2011	\diamond	0	–	SIEP C880700 03D<6>-2, available on the Web.
June 2011	\diamond	2	Front cover	Revision: format
			1.5.1	Revision: Model number of cable-side connector for RS422/485 communication cable 10114-3000VE → 10114-3000PE
			2.1.1	Revision: Hardware specifications
			3.2.4 (1)	Revision: Model number of CPU I/O connector 10120-3000VE → 10120-3000PE
			6.4.5 (1)	Revision: Description of hardware configuration status DIP switch alarms → DIP switch reports
			6.4.5 (3) [b]	Revision: Error Drawing Number Function: 0100H → 8000H
			Back cover	Revision: Address, format
February 2010	\diamond	1	Preface	Revision: Terms used to Describe "Torque"
			2.2.1 (2), 6.3.3 (1)	Revision: Indicator names
			4.3.2 (1)	Revision: Description in step 4 personal computer → Communication Module at the MP2000 Series Machine Controller
October 2009	\diamond	0	–	SIEP C880700 03D<5>-2, available on the Web.
September 2009	\diamond	2	Preface	Addition: Warranty
			Back cover	Revision: Address
August 2009	\diamond	1	1.4.2	Addition: Reference to the relevant manual.
			Back cover	Revision: Address
April 2008	\diamond	0	–	Based on Japanese user's manual, SIJP C880700 03F<11> printed in November 2007.
			Back cover	Revision: Address
February 2006	\diamond	0	All chapters	Revision: All chapters
April 2005	\diamond	0	–	Printed version of the user's manual, SIEP C880700 03B<2>-1, available on the Web.
February 2005	\diamond	1	3.3.3	Revision: H04 Drawing
September 2003	\diamond	0	2.3.2	Addition: I/O Modules JEPMC-AN2900, JEPMC-AN2910
			2.4.2, 10.2	Revision: Battery model
			7.2.2, 7.2.3	Revision: Table (Deletion of size column, addition of parameter No. column)
			11.1.4	Addition: Motion program alarms
July 2003	\diamond	–	Back cover	Revision: Address
April 2003	–	–	–	First edition

Machine Controller MP2300

Basic Module

USER'S MANUAL

IRUMA BUSINESS CENTER (SOLUTION CENTER)

480, Kamifujisawa, Iruma, Saitama 358-8555, Japan
Phone 81-4-2962-5151 Fax 81-4-2962-6138

YASKAWA AMERICA, INC.

2121 Norman Drive South, Waukegan, IL 60085, U.S.A.
Phone (800) YASKAWA (800-927-5292) or 1-847-887-7000 Fax 1-847-887-7310

YASKAWA ELÉTRICO DO BRASIL LTDA.

Avenida Fagundes Filho, 620 São Paulo-SP CEP 04304-000, Brazil
Phone 55-11-3585-1100 Fax 55-11-5581-8795

YASKAWA EUROPE GmbH

Hauptstraße 185, Eschborn 65760, Germany
Phone 49-6196-569-300 Fax 49-6196-569-398

YASKAWA ELECTRIC UK LTD.

1 Hunt Hill Orchardton Woods Cumbernauld, G68 9LF, United Kingdom
Phone 44-1236-735000 Fax 44-1236-458182

YASKAWA ELECTRIC KOREA CORPORATION

7F, Doore Bldg. 24, Yeoido-dong, Yeongdungpo-gu, Seoul 150-877, Korea
Phone 82-2-784-7844 Fax 82-2-784-8495

YASKAWA ELECTRIC (SINGAPORE) PTE. LTD.

151 Lorong Chuan, #04-01, New Tech Park 556741, Singapore
Phone 65-6282-3003 Fax 65-6289-3003

YASKAWA ELECTRIC (SHANGHAI) CO., LTD.

No.18 Xizang Zhong Road. 17F, Harbour Ring Plaza Shanghai 200001, China
Phone 86-21-5385-2200 Fax 86-21-5385-3299

YASKAWA ELECTRIC (SHANGHAI) CO., LTD. BEIJING OFFICE

Room 1011, Tower W3 Oriental Plaza, No.1 East Chang An Ave.,
Dong Cheng District, Beijing 100738, China
Phone 86-10-8518-4086 Fax 86-10-8518-4082

YASKAWA ELECTRIC TAIWAN CORPORATION

9F, 16, Nanking E. Rd., Sec. 3, Taipei 104, Taiwan
Phone 886-2-2502-5003 Fax 886-2-2505-1280



YASKAWA ELECTRIC CORPORATION

In the event that the end user of this product is to be the military and said product is to be employed in any weapons systems or the manufacture thereof, the export will fall under the relevant regulations as stipulated in the Foreign Exchange and Foreign Trade Regulations. Therefore, be sure to follow all procedures and submit all relevant documentation according to any and all rules, regulations and laws that may apply.

Specifications are subject to change without notice for ongoing product modifications and improvements.

© 2003-2011 YASKAWA ELECTRIC CORPORATION. All rights reserved.

MANUAL NO. SIEP C880700 03E

Published in Japan July 2011 03-4 -0
10-10-4